

starting out with >>>

# C++

From Control Structures  
through Objects

NINTH EDITION



TONY GADDIS

starting out with >>>

# C++

From Control Structures  
through Objects

NINTH EDITION



TONY GADDIS

# Starting Out with C++ From Control Structures Through Objects

Ninth Edition

# Starting Out with C++ From Control Structures Through Objects

Ninth Edition

**Tony Gaddis**

Haywood Community College



330 Hudson Street, New York, NY 10013

Senior Vice President Courseware Portfolio Management: Marcia J. Horton

Director, Portfolio Management: Engineering, Computer Science & Global Editions: Julian Partridge

Portfolio Manager: Matt Goldstein

Portfolio Management Assistant: Kristy Alaura

Field Marketing Manager: Demetrius Hall

Product Marketing Manager: Yvonne Vannatta

Managing Producer, ECS and Math: Scott Disanno

Content Producer: Sandra L. Rodriguez

Composition: iEnergizer Aptara<sup>®</sup>, Ltd.

Cover Designer: Joyce Wells

Cover Photo: Samokhin/123RF

Credits and acknowledgments borrowed from other sources and reproduced, with permission, appear on the Credits page in the endmatter of this textbook.

Copyright © 2018, 2015, 2012, 2009 Pearson Education, Inc. Hoboken, NJ 07030. All rights reserved. Manufactured in the United States of America. This publication is protected by copyright and permissions should be obtained from the publisher prior to any prohibited reproduction, storage in a retrieval system, or transmission in any form or by any means, electronic, mechanical, photocopying, recording, or otherwise. For information regarding permissions, request forms and the appropriate contacts within the Pearson Education Global Rights & Permissions department, please visit [www.pearsoned.com/permissions/](http://www.pearsoned.com/permissions/).

Many of the designations by manufacturers and seller to distinguish their products are claimed as trademarks. Where those designations appear in this book, and the publisher was aware of a trademark claim, the designations have been printed in initial caps or all caps.

The author and publisher of this book have used their best efforts in preparing this book. These efforts include the development, research, and testing of theories and programs to determine their effectiveness. The author and publisher make no warranty of any kind, expressed or implied, with regard to these programs or the documentation contained in this book. The author and publisher shall not be liable in any event for incidental or consequential damages with, or arising out of, the furnishing, performance, or use of these programs.

Pearson Education Ltd., London

Pearson Education Singapore, Pte. Ltd

Pearson Education Canada, Inc.

Pearson Education Japan

Pearson Education Australia PTY, Ltd

Pearson Education North Asia, Ltd., Hong Kong

Pearson Education de Mexico, S.A. de C.V.

Pearson Education Malaysia, Pte. Ltd.

Pearson Education, Inc., Hoboken

### **Library of Congress Cataloging-in-Publication Data**

Names: Gaddis, Tony, author.

Title: Starting out with C++. From control structures through objects /  
Tony Gaddis, Haywood Community College.

Other titles: From control structures through objects | Starting out  
with C plus plus. From control structures through objects

Description: Ninth edition. | Boston : Pearson Education, Inc., [2017]

Identifiers: LCCN 2016056456 | ISBN 9780134498379 (alk. paper) | ISBN 0134498372 (alk. paper)

Subjects: LCSH: C++ (Computer program language)

Classification: LCC QA76.73.C153 G334 2017 | DDC 005.13/3—dc23 LC record available at <https://lcn.loc.gov/2016056456>

1 17



ISBN-13: 978-0-13-449837-9

ISBN-10: 0-13-449837-2



# Contents at a Glance

Preface xvii 

Chapter 1 Introduction to Computers and Programming 1 

Chapter 2 Introduction to C++ 27 

Chapter 3 Expressions and Interactivity 85 

Chapter 4 Making Decisions 151 

Chapter 5 Loops and Files 231 

Chapter 6 Functions 305 

Chapter 7 Arrays and Vectors 381 

Chapter 8 Searching and Sorting Arrays 463 

Chapter 9 Pointers 503 

Chapter 10 Characters, C-Strings, and More about the `string` Class 557 

Chapter 11 Structured Data 613 

Chapter 12 Advanced File Operations 665 

Chapter 13 Introduction to Classes 719 

Chapter 14 More about Classes 817 

**Chapter 15 Inheritance, Polymorphism, and Virtual Functions**  
907 

**Chapter 16 Exceptions and Templates** 989 

**Chapter 17 The Standard Template Library** 1029 

**Chapter 18 Linked Lists** 1123 

**Chapter 19 Stacks and Queues** 1165 

**Chapter 20 Recursion** 1223 

**Chapter 21 Binary Trees** 1257 

**Appendix A: The ASCII Character Set** 1287 

**Appendix B: Operator Precedence and Associativity** 1289 

**Quick References** 1291 

**Index** 1293 

**Credit** 1311 

Online The following appendices are available at  
[www.pearsonhighered.com/gaddis](http://www.pearsonhighered.com/gaddis).

Appendix C: Introduction to Flowcharting

Appendix D: Using UML in Class Design

Appendix E: Namespaces

Appendix F: Passing Command Line Arguments

Appendix G: Binary Numbers and Bitwise Operations

Appendix H: STL Algorithms

Appendix I: Multi-Source File Programs

Appendix J: Stream Member Functions for Formatting

Appendix K: Unions

Appendix L: Answers to Checkpoints

Appendix M: Answers to Odd Numbered Review Questions

Case Study 1: String Manipulation

Case Study 2: High Adventure Travel Agency—Part 1

Case Study 3: Loan Amortization

Case Study 4: Creating a String Class

Case Study 5: High Adventure Travel Agency—Part 2

Case Study 6: High Adventure Travel Agency—Part 3

Case Study 7: Intersection of Sets

Case Study 8: Sales Commission

# Contents

Preface xxiii 

Chapter 1 Introduction to Computers and Programming 1 

1.1 Why Program? 1 

1.2 Computer Systems: Hardware and Software 2 

1.3 Programs and Programming Languages 8 

1.4 What Is a Program Made of? 14 

1.5 Input, Processing, and Output 17 

1.6 The Programming Process 18 

1.7 Procedural and Object-Oriented Programming 22 

Review Questions and Exercises 24 

Chapter 2 Introduction to C++ 27 

2.1 The Parts of a C++ Program 27 

2.2 The `cout` Object 31 

2.3 The `#include` Directive 36 

2.4 Variables, Literals, and Assignment Statements 38 

2.5 Identifiers 42 

2.6 Integer Data Types 43 

2.7 The `char` Data Type 49 

2.8 The C++ `string` Class 53 

2.9 Floating-Point Data Types 55 

2.10 The `bool` Data Type 58 

2.11 Determining the Size of a Data Type 59 

2.12 More about Variable Assignments and Initialization 60 

2.13 Scope 62 

2.14 Arithmetic Operators 63 

2.15 Comments 71 

2.16 Named Constants 73 

2.17 Programming Style 75 

Review Questions and Exercises 77 

Programming Challenges 81 

Chapter 3 Expressions and Interactivity 85 

3.1 The `cin` Object 85 

3.2 Mathematical Expressions 91 

3.3 When You Mix Apples and Oranges: Type Conversion 100 

3.4 Overflow and Underflow 102 

3.5 Type Casting 103 

**3.6 Multiple Assignment and Combined Assignment 106** 

**3.7 Formatting Output 110** 

**3.8 Working with Characters and `string` Objects 120** 

**3.9 More Mathematical Library Functions 126** 

**3.10 Focus on Debugging: Hand Tracing a Program 132** 

**3.11 Focus on Problem Solving: A Case Study 134** 

**Review Questions and Exercises 138** 

**Programming Challenges 144** 

**Chapter 4 Making Decisions 151** 

**4.1 Relational Operators 151** 

**4.2 The `if` Statement 156** 

**4.3 Expanding the `if` Statement 164** 

**4.4 The `if/else` Statement 168** 

**4.5 Nested `if` Statements 171** 

**4.6 The `if/else if` Statement 178** 

**4.7 Flags 183** 

**4.8 Logical Operators 184** 

**4.9 Checking Numeric Ranges with Logical Operators 191** 

**4.10 Menus 192** 

**4.11 Focus on Software Engineering: Validating User Input 195** 

**4.12 Comparing Characters and Strings 197** 

**4.13 The Conditional Operator 201** 

**4.14 The `switch` Statement 204** 

**4.15 More about Blocks and Variable Scope 213** 

**Review Questions and Exercises 216** 

**Programming Challenges 222** 

**Chapter 5 Loops and Files 231** 

**5.1 The Increment and Decrement Operators 231** 

**5.2 Introduction to Loops: The `while` Loop 236** 

**5.3 Using the `while` Loop for Input Validation 243** 

**5.4 Counters 245** 

**5.5 The `do-while` Loop 246** 

**5.6 The `for` Loop 251** 

**5.7 Keeping a Running Total 261** 

**5.8 Sentinels 264** 

**5.9 Focus on Software Engineering: Deciding Which Loop to Use 265** 

**5.10 Nested Loops 266** 

**5.11 Using Files for Data Storage 269** 

**5.12 Optional Topics: Breaking and Continuing a Loop 288** 

**Review Questions and Exercises 292** 

**Programming Challenges 297** 

**Chapter 6 Functions 305** 

**6.1 Focus on Software Engineering: Modular Programming 305** 

**6.2 Defining and Calling Functions 306** 

**6.3 Function Prototypes 315** 

**6.4 Sending Data into a Function 317** 

**6.5 Passing Data by Value 322** 

**6.6 Focus on Software Engineering: Using Functions in a Menu-Driven Program 324** 

**6.7 The `return` Statement 328** 

**6.8 Returning a Value from a Function 330** 

**6.9 Returning a Boolean Value 338** 

**6.10 Local and Global Variables 340** 

**6.11 Static Local Variables 348** 

**6.12 Default Arguments 351** 

**6.13 Using Reference Variables as Parameters 354** 

**6.14 Overloading Functions 360** 

**6.15 The `exit()` Function 364** 



6.16 Stubs and Drivers 367   
Review Questions and Exercises 369   
Programming Challenges 372 

## Chapter 7 Arrays and Vectors 381

7.1 Arrays Hold Multiple Values 381   
7.2 Accessing Array Elements 383   
7.3 No Bounds Checking in C++ 395   
7.4 The Range-Based `for` Loop 398   
7.5 Processing Array Contents 402   
7.6 Focus on Software Engineering: Using Parallel Arrays 410   
7.7 Arrays as Function Arguments 413   
7.8 Two-Dimensional Arrays 424   
7.9 Arrays with Three or More Dimensions 431   
7.10 Focus on Problem Solving and Program Design: A Case Study 433   
7.11 Introduction to the STL `vector` 435   
Review Questions and Exercises 449   
Programming Challenges 454 

## Chapter 8 Searching and Sorting Arrays 463

**8.1 Focus on Software Engineering: Introduction to Search Algorithms 463** 

**8.2 Focus on Problem Solving and Program Design: A Case Study 469** 

**8.3 Focus on Software Engineering: Introduction to Sorting Algorithms 476** 

**8.4 Focus on Problem Solving and Program Design: A Case Study 486** 

**8.5 Sorting and Searching vectors 495** 

**Review Questions and Exercises 498** 

**Programming Challenges 499** 

**Chapter 9 Pointers 503** 

**9.1 Getting the Address of a Variable 503** 

**9.2 Pointer Variables 505** 

**9.3 The Relationship between Arrays and Pointers 512** 

**9.4 Pointer Arithmetic 516** 

**9.5 Initializing Pointers 518** 


**9.6 Comparing Pointers 519** 

**9.7 Pointers as Function Parameters 521** 

**9.8 Dynamic Memory Allocation 530** 

**9.9 Returning Pointers from Functions 534** 

**9.10 Using Smart Pointers to Avoid Memory Leaks 541** 

**9.11 Focus on Problem Solving and Program Design: A Case Study 544** 

**Review Questions and Exercises 550** 

**Programming Challenges 553** 

**Chapter 10 Characters, C-Strings, and More about the `string` Class 557** 

**10.1 Character Testing 557** 

**10.2 Character Case Conversion 561** 


**10.3 C-Strings 564** 

**10.4 Library Functions for Working with C-Strings 568** 

**10.5 String/Numeric Conversion Functions 579** 

**10.6 Focus on Software Engineering: Writing Your Own C-String-Handling Functions 585** 

**10.7 More about the C++ `string` Class 591** 

**10.8 Focus on Problem Solving and Program Design: A Case Study 603** 

**Review Questions and Exercises 604** 

**Programming Challenges 607** 

**Chapter 11 Structured Data 613** 

**11.1 Abstract Data Types 613** 

**11.2 Structures 615** 

**11.3 Accessing Structure Members 618** 

**11.4 Initializing a Structure 622** 

**11.5 Arrays of Structures 625** 

**11.6 Focus on Software Engineering: Nested Structures 627** 

**11.7 Structures as Function Arguments 631** 

**11.8 Returning a Structure from a Function 634** 

**11.9 Pointers to Structures 637** 

**11.10 Focus on Software Engineering: When to Use ., When to Use `->`, and When to Use `*` 640** 

**11.11 Enumerated Data Types 642** 

**Review Questions and Exercises 653** 

**Programming Challenges 659** 

**Chapter 12 Advanced File Operations 665** 

**12.1 File Operations 665** 

**12.2 File Output Formatting 671** 

**12.3 Passing File Stream Objects to Functions 673** 

**12.4 More Detailed Error Testing 675** 

**12.5 Member Functions for Reading and Writing Files 678** 

**12.6 Focus on Software Engineering: Working with Multiple Files 686** 

**12.7 Binary Files 688** 

**12.8 Creating Records with Structures 693** 

**12.9 Random-Access Files 697** 

**12.10 Opening a File for Both Input and Output 705** 

**Review Questions and Exercises 710** 

**Programming Challenges 713** 

**Chapter 13 Introduction to Classes 719** 

**13.1 Procedural and Object-Oriented Programming 719** 

**13.2 Introduction to Classes 726** 

**13.3 Defining an Instance of a Class 731** 

**13.4 Why Have Private Members? 744** 

**13.5 Focus on Software Engineering: Separating Class Specification from Implementation 745** 

**13.6 Inline Member Functions 751** 

**13.7 Constructors 754** 


**13.8 Passing Arguments to Constructors 759** 

**13.9 Destructors 767** 

**13.10 Overloading Constructors 771** 

**13.11 Private Member Functions 775** 

**13.12 Arrays of Objects 777** 

**13.13 Focus on Problem Solving and Program Design: An OOP Case Study 781** 

**13.14 Focus on Object-Oriented Programming: Simulating Dice with Objects 788** 

**13.15 Focus on Object-Oriented Design: The Unified Modeling Language (UML) 792** 

**13.16 Focus on Object-Oriented Design: Finding the Classes and Their Responsibilities 794** 

**Review Questions and Exercises 803** 

**Programming Challenges 808** 

**Chapter 14 More about Classes 817** 

**14.1 Instance and Static Members 817** 

**14.2 Friends of Classes 825** 

**14.3 Memberwise Assignment 830** 

**14.4 Copy Constructors 831** 

**14.5 Operator Overloading 837** 

**14.6 Object Conversion 864** 

**14.7 Aggregation 866** 

**14.8 Focus on Object-Oriented Design: Class Collaborations 871** 

**14.9 Focus on Object-Oriented Programming: Simulating the Game of Cho-Han 876** 

**14.10 Rvalue References and Move Semantics 886** 


**Review Questions and Exercises 895** 

**Programming Challenges 900** 

**Chapter 15 Inheritance, Polymorphism, and Virtual Functions 907** 

**15.1 What Is Inheritance? 907** 

**15.2 Protected Members and Class Access 916** 

**15.3 Constructors and Destructors in Base and Derived  
Classes 922** 

**15.4 Redefining Base Class Functions 936** 

**15.5 Class Hierarchies 941** 

**15.6 Polymorphism and Virtual Member Functions 947** 

**15.7 Abstract Base Classes and Pure Virtual Functions 963** 

**15.8 Multiple Inheritance 970** 

**Review Questions and Exercises 977** 

**Programming Challenges 981** 

**Chapter 16 Exceptions and Templates 989** 

**16.1 Exceptions 989** 

**16.2 Function Templates 1008** 

**16.3 Focus on Software Engineering: Where to Start When  
Defining Templates 1014** 

**16.4 Class Templates 1014** 

[Review Questions and Exercises 1024](#) 

[Programming Challenges 1026](#) 

**Chapter 17 The Standard Template Library 1029** 

[17.1 Introduction to the Standard Template Library 1029](#) 

[17.2 STL Container and Iterator Fundamentals 1029](#) 

[17.3 The `vector` Class 1040](#) 

[17.4 The `map`, `multimap`, and `unordered\_map` Classes 1054](#) 

[17.5 The `set`, `multiset`, and `unordered\_set` Classes 1079](#) 

[17.6 Algorithms 1086](#) 

[17.7 Introduction to Function Objects and Lambda Expressions 1107](#) 

[Review Questions and Exercises 1114](#) 

[Programming Challenges 1118](#) 

**Chapter 18 Linked Lists 1123** 

[18.1 Introduction to the Linked List ADT 1123](#) 

[18.2 Linked List Operations 1125](#) 

[18.3 A Linked List Template 1141](#) 

[18.4 Variations of the Linked List 1153](#) 

[18.5 The STL `list` and `forward\_list` Containers 1154](#) 



[Review Questions and Exercises 1158](#) 

[Programming Challenges 1161](#) 

**Chapter 19 Stacks and Queues 1165** 

[19.1 Introduction to the Stack ADT 1165](#) 

[19.2 Dynamic Stacks 1182](#) 

[19.3 The STL `stack` Container 1193](#) 

[19.4 Introduction to the Queue ADT 1195](#) 

[19.5 Dynamic Queues 1207](#) 

[19.6 The STL `deque` and `queue` Containers 1214](#) 

[Review Questions and Exercises 1217](#) 

[Programming Challenges 1219](#) 


**Chapter 20 Recursion 1223** 

[20.1 Introduction to Recursion 1223](#) 

[20.2 Solving Problems with Recursion 1227](#) 


[20.3 Focus on Problem Solving and Program Design: The Recursive `gcd` Function 1235](#) 

[20.4 Focus on Problem Solving and Program Design: Solving Recursively Defined Problems 1236](#) 

[20.5 Focus on Problem Solving and Program Design: Recursive Linked List Operations 1237](#) 

**20.6 Focus on Problem Solving and Program Design: A Recursive Binary Search Function 1241** 

**20.7 The Towers of Hanoi 1243** 

**20.8 Focus on Problem Solving and Program Design: The QuickSort Algorithm 1246** 

**20.9 Exhaustive Algorithms 1250** 

**20.10 Focus on Software Engineering: Recursion versus Iteration 1253** 

**Review Questions and Exercises 1253** 

**Programming Challenges 1255** 

**Chapter 21 Binary Trees 1257** 

**21.1 Definition and Applications of Binary Trees 1257** 

**21.2 Binary Search Tree Operations 1260** 

**21.3 Template Considerations for Binary Search Trees 1277** 

**Review Questions and Exercises 1283** 

**Programming Challenges 1284** 

**Appendix A: The ASCII Character Set 1287** 

**Appendix B: Operator Precedence and Associativity 1289** 

**Quick References 1291** 

**Index 1293** 

**Credit 1311** 

Online The following appendices are available at [www.pearsonhighered.com/gaddis](http://www.pearsonhighered.com/gaddis).

Appendix C: Introduction to Flowcharting

Appendix D: Using UML in Class Design

Appendix E: Namespaces

Appendix F: Passing Command Line Arguments

Appendix G: Binary Numbers and Bitwise Operations

Appendix H: STL Algorithms

Appendix I: Multi-Source File Programs

Appendix J: Stream Member Functions for Formatting

Appendix K: Unions

Appendix L: Answers to Checkpoints

Appendix M: Answers to Odd Numbered Review Questions

Case Study 1: String Manipulation

Case Study 2: High Adventure Travel Agency—Part 1

Case Study 3: Loan Amortization

Case Study 4: Creating a String Class

Case Study 5: High Adventure Travel Agency—Part 2

Case Study 6: High Adventure Travel Agency—Part 3

Case Study 7: Intersection of Sets

## Case Study 8: Sales Commission




# Preface

Welcome to *Starting Out with C++: From Control Structures through Objects, 9th edition*. This book is intended for use in a two-semester C++ programming sequence, or an accelerated one-semester course. Students new to programming, as well as those with prior course work in other languages, will find this text beneficial. The fundamentals of programming are covered for the novice, while the details, pitfalls, and nuances of the C++ language are explored in depth for both the beginner and more experienced student. The book is written with clear, easy-to-understand language, and it covers all the necessary topics for an introductory programming course. This text is rich in example programs that are concise, practical, and real-world oriented, ensuring that the student not only learns how to implement the features and constructs of C++, but why and when to use them.

# Changes in the Ninth Edition

This book's pedagogy, organization, and clear writing style remain the same as in the previous edition. Many improvements and updates have been made, which are summarized here:

- The material on the Standard Template Library (STL) has been completely rewritten and expanded into its own chapter. Previously, [Chapter 16](#) covered exceptions, templates, and gave brief coverage to the STL. In this edition, [Chapter 16](#) covers exceptions and templates, and [Chapter 17](#) is a new chapter dedicated to the STL. The new chapter covers the following topics:
  - The `array` and `vector` classes
  - The various types of iterators
  - Emplacement versus insertion
  - The `map`, `multimap`, and `unordered_map` Classes
  - The `set`, `multiset`, and `unordered_set` Classes
  - Sorting and searching algorithms
  - Permutation algorithms
  - Set algorithms
  - Using function pointers with STL algorithms
  - Function objects, or functors
  - Lambda expressions
- [Chapter 2](#) now includes a discussion of alternative forms of variable initialization, including functional notation, and brace notation (also known as uniform initialization).
- [Chapter 3](#) now mentions the `round` function, introduced in C++ 11.
- [Chapter 7](#) now introduces array initialization much earlier.
- In [Chapter 8](#), the bubble sort algorithm has been rewritten and improved.
- A new example of sorting and searching a `vector` of strings has been added to [Chapter 8](#).
- In [Chapter 9](#), the section on smart pointers now gives an overview of `shared_ptr`s and `weak_ptr`s, in addition to the existing coverage of `unique_ptr`s.
- In [Chapter 10](#), a new *In the Spotlight* section on string tokenizing has been added.
- [Chapter 10](#) now covers the `string`-to-number conversion functions that were introduced in C++ 11.
- The material on unions that previously appeared in [Chapter 11](#) has been moved to Appendix K, available on the book's companion Website.
- [Chapter 13](#) has new sections covering:
  - Member initialization lists.
  - In-place initialization.
  - Constructor delegation.
- Several new topics were added to [Chapter 14](#), including:
  - Rvalue references and move semantics.
  - Checking for self-assignment when overloading the `=` operator.
  - Using member initialization lists in aggregate classes.

- **Chapter 15**  includes a new section on constructor inheritance.
- Several new programming problems have been added throughout the book.

## Organization of the Text


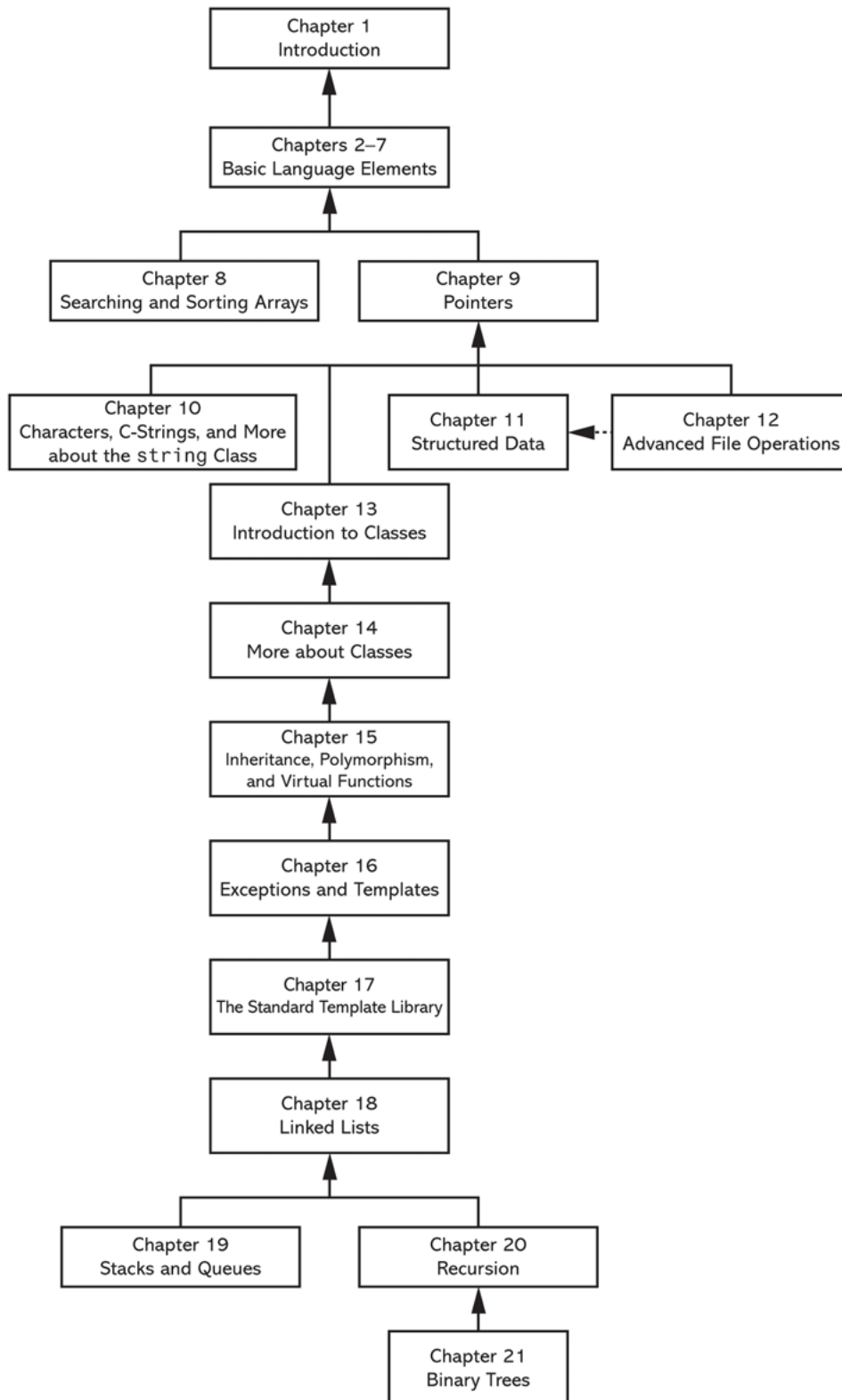
This text teaches C++ in a step-by-step fashion. Each chapter covers a major set of topics and builds knowledge as the student progresses through the book. Although the chapters can be easily taught in their existing sequence, some flexibility is provided. The diagram shown in **Figure P-1**  suggests possible sequences of instruction.



Figure P-1 Chapter dependency chart



**Chapter 1** covers fundamental hardware, software, and programming concepts. You may choose to skip this chapter if the class is already familiar with those topics. **Chapters 2** through **7** cover basic C++ syntax, data types, expressions, selection structures, repetition structures, functions, and arrays. Each of these chapters builds on the previous chapter and should be covered in the order presented.

After **Chapter 7** has been covered, you may proceed to **Chapter 8**, or jump to **Chapter 9**.

After **Chapter 9** has been covered, **Chapter 10**, **11**, **12** or **13** may be covered. (If you jump to **Chapter 12** at this point, you will need to postpone **Sections 12.8**, **12.9**, and **12.10** until **Chapter 11** has been covered.) After **Chapter 13**, you may cover **Chapters 14** through **18** in sequence. Next, you can proceed to either **Chapter 19** or **Chapter 20**. Finally, **Chapter 21** may be covered.

This text's approach starts with a firm foundation in structured, procedural programming before delving fully into object-oriented programming and advanced data structures.

## Brief Overview of Each Chapter

## *Chapter 1: Introduction to Computers and Programming*

This chapter provides an introduction to the field of computer science and covers the fundamentals of programming, problem solving, and software design. The components of programs, such as key words, variables, operators, and punctuation, are covered. The tools of the trade, such as pseudocode, flow charts, and hierarchy charts, are also presented.

## *Chapter 2: Introduction to C++*

This chapter gets the student started in C++ by introducing data types, identifiers, variable declarations, constants, comments, program output, simple arithmetic operations, and C-strings. Programming style conventions are introduced and good programming style is modeled here, as it is throughout the text.

## *Chapter 3: Expressions and Interactivity*

In this chapter, the student learns to write programs that input and handle numeric, character, and string data. The use of arithmetic operators and the creation of mathematical expressions are covered in greater detail, with emphasis on operator precedence. Debugging is introduced, with a section on hand tracing a program. Sections are also included on simple output formatting, on data type conversion and type casting, and on using library functions that work with numbers.

## *Chapter 4: Making Decisions*

Here, the student learns about relational operators, relational expressions, and how to control the flow of a program with the `if`, `if/else`, and `if/else if` statements. The conditional operator and the `switch` statement are also covered. Crucial applications of these constructs are covered, such as menu-driven programs and the validation of input.

## *Chapter 5: Loops and Files*

This chapter covers repetition control structures. The `while` loop, `do-while` loop, and `for` loop are taught, along with common uses for these devices. Counters, accumulators, running totals, sentinels, and other application-related topics are discussed. Sequential file I/O is also introduced. The student learns to read and write text files, and use loops to process the data in a file.

## *Chapter 6: Functions*

In this chapter, the student learns how and why to modularize programs, using both `void` and value returning functions. Argument passing is covered, with emphasis on when arguments should be passed by value versus when they need to be passed by reference. Scope of variables is covered, and sections are provided on local versus global variables and on static local variables. Overloaded functions are also introduced and demonstrated.



## *Chapter 7: Arrays and Vectors*

In this chapter, the student learns to create and work with single and multi-dimensional arrays. Many examples of array processing are provided including examples illustrating how to find the sum, average, highest, and lowest values in an array, and how to sum the rows, columns, and all elements of a two-dimensional array. Programming techniques using parallel arrays are also demonstrated, and the student is shown how to use a data file as an input source to populate an array. STL `vector`s are introduced and compared to arrays.

## *Chapter 8: Searching and Sorting Arrays*

Here, the student learns the basics of sorting arrays and searching for data stored in them. The chapter covers the Bubble Sort, Selection Sort, Linear Search, and Binary Search algorithms. There is also a section on sorting and searching STL `vector` objects.

## *Chapter 9: Pointers*

This chapter explains how to use pointers. Pointers are compared to and contrasted with reference variables. Other topics include pointer arithmetic, initialization of pointers, relational comparison of pointers, pointers and arrays, pointers and functions, dynamic memory allocation, and more.

## *Chapter 10: Characters, C-Strings, and More about the*

### *string* Class

This chapter discusses various ways to process text at a detailed level. Library functions for testing and manipulating characters are introduced. C-strings are discussed, and the technique of storing C-strings in `char` arrays is covered. An extensive discussion of the `string` class methods is also given.

## *Chapter 11: Structured Data*

The student is introduced to abstract data types and taught how to create them using structures, unions, and enumerated data types. Discussions and examples include using pointers to structures, passing structures to functions, and returning structures from functions.

## *Chapter 12: Advanced File Operations*

This chapter covers sequential access, random access, text, and binary files. The various modes for opening files are discussed, as well as the many methods for reading and writing file contents. Advanced output formatting is also covered.

## *Chapter 13: Introduction to Classes*

The student now shifts focus to the object-oriented paradigm. This chapter covers the fundamental concepts of classes. Member variables and functions are discussed. The student learns about private and public access specifications, and reasons to use each. The topics of constructors, overloaded constructors, and destructors are also presented. The chapter presents a section modeling classes with UML, and how to find the classes in a particular problem.

## *Chapter 14: More about Classes*

This chapter continues the study of classes. Static members, friends, memberwise assignment, and copy constructors are discussed. The chapter also includes in-depth sections on operator overloading, object conversion, and object aggregation. There is also a section on class collaborations and the use of CRC cards.



## *Chapter 15: Inheritance, Polymorphism, and Virtual Functions*

The study of classes continues in this chapter with the subjects of inheritance, polymorphism, and virtual member functions. The topics covered include base and derived class constructors and destructors, virtual member functions, base class pointers, static and dynamic binding, multiple inheritance, and class hierarchies.

## *Chapter 16: Exceptions and Templates*

The student learns to develop enhanced error trapping techniques using exceptions. Discussion then turns to function and class templates as a method for reusing code.

## *Chapter 17: The Standard Template Library*

This chapter discusses the containers, iterators, and algorithms in the Standard Template Library (STL). The specific containers covered are the `array`, `vector`, `map`, `multimap`, `unordered_map`, `set`, `multiset`, and `unordered_set` classes. The student then learns about sorting, searching, permutation, and set algorithms. The chapter concludes with a discussion of function objects (functors) and lambda functions.

## *Chapter 18: Linked Lists*

This chapter introduces concepts and techniques needed to work with lists. A linked list ADT is developed and the student is taught to code operations such as creating a linked list, appending a node, traversing the list, searching for a node, inserting a node, deleting a node, and destroying a list. A linked list class template is also demonstrated.

## *Chapter 19: Stacks and Queues*

In this chapter, the student learns to create and use static and dynamic stacks and queues. The operations of stacks and queues are defined, and templates for each ADT are demonstrated.

## *Chapter 20: Recursion*

This chapter discusses recursion and its use in problem solving. A visual trace of recursive calls is provided, and recursive applications are discussed. Many recursive algorithms are presented, including recursive functions for finding factorials, finding a greatest common denominator (GCD), performing a binary search, and sorting (QuickSort). The classic Towers of Hanoi example is also presented. For students who need more challenge, there is a section on exhaustive algorithms.

## *Chapter 21: Binary Trees*

This chapter covers the binary tree ADT and demonstrates many binary tree operations. The student learns to traverse a tree, insert an element, delete an element, replace an element, test for an element, and destroy a tree.

## *Appendix A: The ASCII Character Set*

A list of the ASCII and Extended ASCII characters and their codes

## *Appendix B: Operator Precedence and Associativity*

A chart showing the C++ operators and their precedence

The following appendices are available online at [www.pearsonhighered.com/gaddis](http://www.pearsonhighered.com/gaddis).

## *Appendix C: Introduction to Flowcharting*

A brief introduction to flowcharting. This tutorial discusses sequence, decision, case, repetition, and module structures.

## *Appendix D: Using UML in Class Design*

This appendix shows the student how to use the Unified Modeling Language to design classes. Notation for showing access specification, data types, parameters, return values, overloaded functions, composition, and inheritance are included.

## *Appendix E: Namespaces*

This appendix explains namespaces and their purpose. Examples showing how to define a namespace and access its members are given.

## *Appendix F: Passing Command Line Arguments*

Teaches the student how to write a C++ program that accepts arguments from the command line. This appendix will be useful to students working in a command line environment, such as Unix, Linux, or the Windows command prompt.

## *Appendix G: Binary Numbers and Bitwise Operations*

A guide to the C++ bitwise operators, as well as a tutorial on the internal storage of integers

## *Appendix H: STL Algorithms*

This appendix gives a summary of each of the function templates provided by the Standard Template Library (STL), and defined in the `<algorithm>` header file.

## *Appendix I: Multi-Source File Programs*

Provides a tutorial on creating programs that consist of multiple source files. Function header files, class specification files, and class implementation files are discussed.

## *Appendix J: Stream Member Functions for Formatting*

Covers stream member functions for formatting such as `setf`

## *Appendix K: Unions*

This appendix introduces unions. It describes the purpose of unions and the difference between a union and a `struct`, demonstrates how to declare a union and define a union variable, and shows example programs that use unions.

## *Appendix L: Answers to Checkpoints*

Students may test their own progress by comparing their answers to the Checkpoint exercises against this appendix. The answers to all Checkpoints are included.

## *Appendix M: Answers to Odd Numbered Review Questions*

Another tool that students can use to gauge their progress

## Features of the Text



# Supplements

## *Student Online Resources*

Many student resources are available for this book from the publisher. The following items are available on the Computer Science Portal at [www.pearsonhighered.com/gaddis](http://www.pearsonhighered.com/gaddis):

- The source code for each example program in the book
- Access to the book's VideoNotes
- A full set of appendices, including answers to the Checkpoint questions and answers to the odd-numbered review questions
- A collection of valuable Case Studies
- The complete Serendipity Booksellers Project

## *Online Practice and Assessment with MyProgrammingLab*

**MyProgrammingLab** helps students fully grasp the logic, semantics, and syntax of programming. Through practice exercises and immediate, personalized feedback, **MyProgrammingLab** improves the programming competence of beginning students who often struggle with the basic concepts and paradigms of popular high-level programming languages.

A self-study and homework tool, a **MyProgrammingLab** course consists of hundreds of small practice exercises organized around the structure of this textbook. For students, the system automatically detects errors in the logic and syntax of their code submissions and offers targeted hints that enable students to figure out what went wrong—and why. For instructors, a comprehensive gradebook tracks correct and incorrect answers and stores the code inputted by students for review.

**MyProgrammingLab** is offered to users of this book in partnership with Turing's Craft, the makers of the CodeLab interactive programming exercise system. For a full demonstration, to see feedback from instructors and students, or to get started using **MyProgrammingLab** in your course, visit [www.myprogramminglab.com](http://www.myprogramminglab.com).

## *Instructor Resources*

The following supplements are available only to qualified instructors:

- Answers to all Review Questions in the text
- Solutions for all Programming Challenges in the text
- PowerPoint presentation slides for every chapter
- Computerized test bank
- Answers to all Student Lab Manual questions
- Solutions for all Student Lab Manual programs

Visit the Pearson Instructor Resource Center ([www.pearsonhighered.com/irc](http://www.pearsonhighered.com/irc)) for information on how to access instructor resources.

## *Textbook Web site*

Student and instructor resources, including links to download Microsoft® Visual Studio Express and other popular IDEs, for all the books in the Gaddis *Starting Out with* series can be accessed at the following URL:

<http://www.pearsonhighered.com/gaddis>

# Which Gaddis C++ book is right for you?

The Starting Out with C++ Series includes three books, one of which is sure to fit your course:

- *Starting Out with C++: From Control Structures through Objects*
- *Starting Out with C++: Early Objects*
- *Starting Out with C++: Brief Version*

The following chart will help you determine which book is right for your course.

# Acknowledgments

There have been many helping hands in the development and publication of this text. We would like to thank the following faculty reviewers for their helpful suggestions and expertise.

## **Reviewers for the 9th Edition**

Chia-Chin Chang  
*Lakeland College*

William Duncan  
*Louisiana State University*

Pranshu Gupta  
*DeSales University*

Charles Hardnett  
*Gwinnett Technical College*

Svetlana Marzelli  
*Atlantic Cape Community College*

Jie Meichsner  
*St. Cloud State University*

Ron Del Porto  
*Penn State Erie, The Behrend College*

Lisa Rudnitsky  
*Baruch College*

## **Reviewers for Previous Editions**

Ahmad Abuhejleh  
*University of Wisconsin–River Falls*

David Akins  
*El Camino College*

Steve Allan  
*Utah State University*

Vicki Allan  
*Utah State University*

Karen M. Arlien  
*Bismark State College*

Mary Astone  
*Troy University*

Ijaz A. Awan  
*Savannah State University*

Robert Baird  
*Salt Lake Community College*

Don Biggerstaff  
*Fayetteville Technical Community College*

Michael Bolton  
*Northeastern Oklahoma State University*

Bill Brown  
*Pikes Peak Community College*

Robert Burn  
*Diablo Valley College*

Charles Cadenhead  
*Richland Community College*

Randall Campbell  
*Morningside College*

Wayne Caruolo  
*Red Rocks Community College*

Cathi Chambley-Miller  
*Aiken Technical College*

C.C. Chao  
*Jacksonville State University*

Joseph Chao  
*Bowling Green State University*

Royce Curtis  
*Western Wisconsin Technical College*

Joseph DeLibero  
*Arizona State University*

Michael Dixon  
*Sacramento City College*

Jeanne Douglas  
*University of Vermont*

Michael Dowell  
*Augusta State University*

Qiang Duan  
*Penn State University—Abington*

William E. Duncan  
*Louisiana State University*

Daniel Edwards  
*Ohlone College*

Judy Etchison  
*Southern Methodist University*

Dennis Fairclough  
*Utah Valley State College*

Xisheng Fang  
*Ohlone College*

Mark Fienup  
*University of Northern Iowa*

Richard Flint  
*North Central College*

Ann Ford Tyson  
*Florida State University*

Jeanette Gibbons  
*South Dakota State University*

James Gifford  
*University of Wisconsin–Stevens Point*

Leon Gleiberman  
*Touro College*

Barbara Guillott  
*Louisiana State University*

Ranette Halverson, Ph.D.  
*Midwestern State University*

Ken Hang  
*Green River Community College*

Carol Hannahs  
*University of Kentucky*

Dennis Heckman  
*Portland Community College*

Ric Heishman  
*George Mason University*

Michael Hennessy  
*University of Oregon*

Ilga Higbee  
*Black Hawk College*

Patricia Hines  
*Brookdale Community College*

Mike Holland  
*Northern Virginia Community College*



Mary Hovik  
*Lehigh Carbon Community College*

Richard Hull  
*Lenoir-Rhyne College*

Kay Johnson  
*Community College of Rhode Island*

Chris Kardaras  
*North Central College*

Willard Keeling  
*Blue Ridge Community College*

A.J. Krygeris  
*Houston Community College*

Sheila Lancaster  
*Gadsden State Community College*

Ray Larson  
*Inver Hills Community College*

Michelle Levine  
*Broward College*

Jennifer Li  
*Ohlone College*

Norman H. Liebling  
*San Jacinto College*

Cindy Lindstrom  
*Lakeland College*

Zhu-qu Lu  
*University of Maine, Presque Isle*

Heidar Malki  
*University of Houston*

Debbie Mathews  
*J. Sargeant Reynolds Community College*

Rick Matzen  
*Northeastern State University*

Robert McDonald  
*East Stroudsburg University*

James McGuffee  
*Austin Community College*

Dean Mellas  
*Cerritos College*

Lisa Milkowski  
*Milwaukee School of Engineering*

Marguerite Nedreberg  
*Youngstown State University*

Lynne O'Hanlon  
*Los Angeles Pierce College*

Frank Paiano  
*Southwestern Community College*

Theresa Park  
*Texas State Technical College*

Mark Parker  
*Shoreline Community College*

Tino Posillico  
*SUNY Farmingdale*

Frederick Pratter  
*Eastern Oregon University*

Susan L. Quick  
*Penn State University*

Alberto Ramon  
*Diablo Valley College*

Bazlur Rasheed  
*Sault College of Applied Arts and Technology*

Farshad Ravanshad  
*Bergen Community College*

Susan Reeder  
*Seattle University*

Sandra Roberts  
*Snead College*

Lopa Roychoudhuri  
*Angelo State University*

Dolly Samson  
*Weber State University*

Ruth Sapir  
*SUNY Farmingdale*

Jason Schatz  
*City College of San Francisco*

Dr. Sung Shin  
*South Dakota State University*

Bari Siddique  
*University of Texas at Brownsville*

William Slater  
*Collin County Community College*

Shep Smithline  
*University of Minnesota*

Richard Snyder  
*Lehigh Carbon Community College*

Donald Southwell  
*Delta College*

Caroline St. Claire  
*North Central College*

Kirk Stephens  
*Southwestern Community College*

Cherie Stevens  
*South Florida Community College*

Dale Suggs  
*Campbell University*

Mark Swanson  
*Red Wing Technical College*

Ann Sudell Thorn  
*Del Mar College*

Martha Tillman  
*College of San Mateo*

Ralph Tomlinson  
*Iowa State University*

David Topham  
*Ohlone College*

Robert Tureman  
*Paul D. Camp Community College*

Arisa K. Ude  
*Richland College*

Peter van der Goes  
*Rose State College*

Stewart Venit  
*California State University, Los Angeles*

Judy Walters  
*North Central College*

John H. Whipple  
*Northampton Community College*

Aurelia Williams  
*Norfolk State University*

Chadd Williams  
*Pacific University*

Vida Winans  
*Illinois Institute of Technology*

I would also like to thank my family and friends for their support in all of my projects. I am extremely fortunate to have Matt Goldstein as my editor, and Kristy Alaura as editorial assistant. Their guidance and encouragement made it a pleasure to write chapters and meet deadlines. I am also fortunate to have Demetrius Hall as my marketing manager. His hard work is truly inspiring, and he does a great job of getting this book out to the academic community. The production team, led by Sandra Rodriguez, worked tirelessly to make this book a reality. Thanks to you all!

## About the Author

Tony Gaddis is the principal author of the *Starting Out with* series of textbooks. He has nearly two decades of experience teaching computer science courses, primarily at Haywood Community College. Tony is a highly acclaimed instructor who was previously selected as the North Carolina Community College Teacher of the Year and has received the Teaching Excellence award from the National Institute for Staff and Organizational Development. The *Starting Out with* series includes introductory textbooks covering Programming Logic and Design, Alice, C++, Java™, Microsoft® Visual Basic®, Microsoft® Visual C#, Python, and App Inventor, all published by Pearson.

# MyProgrammingLab™

Through the power of practice and immediate personalized feedback, MyProgrammingLab helps improve your students' performance.

## PROGRAMMING PRACTICE

With MyProgrammingLab, your students will gain first-hand programming experience in an interactive online environment.

## IMMEDIATE, PERSONALIZED FEEDBACK

MyProgrammingLab automatically detects errors in the logic and syntax of their code submission and offers targeted hints that enables students to figure out what went wrong and why.

## GRADUATED COMPLEXITY

MyProgrammingLab breaks down programming concepts into short, understandable sequences of exercises. Within each sequence the level and sophistication of the exercises increase gradually but steadily.

## DYNAMIC ROSTER

Students' submissions are stored in a roster that indicates whether the submission is correct, how many attempts were made, and the actual code submissions from each attempt.

## PEARSON eTEXT

The Pearson eText gives students access to their textbook anytime, anywhere.

## STEP-BY-STEP VIDEONOTE TUTORIALS

These step-by-step video tutorials enhance the programming concepts presented in select Pearson textbooks.

For more information and titles available with **MyProgrammingLab**, please visit [www.myprogramminglab.com](http://www.myprogramminglab.com).

Copyright © 2018 Pearson Education, Inc. or its affiliate(s). All rights reserved. HELO88173 • 11/15



---

# Chapter 1 Introduction to Computers and Programming

---

## Topics

1.1 Why Program? 

1.2 Computer Systems: Hardware and Software 

1.3 Programs and Programming Languages 

1.4 What Is a Program Made of? 

1.5 Input, Processing, and Output 

1.6 The Programming Process 

1.7 Procedural and Object-Oriented Programming 

# 1.1 Why Program?

## **Concept:**

Computers can do many different jobs because they are programmable.

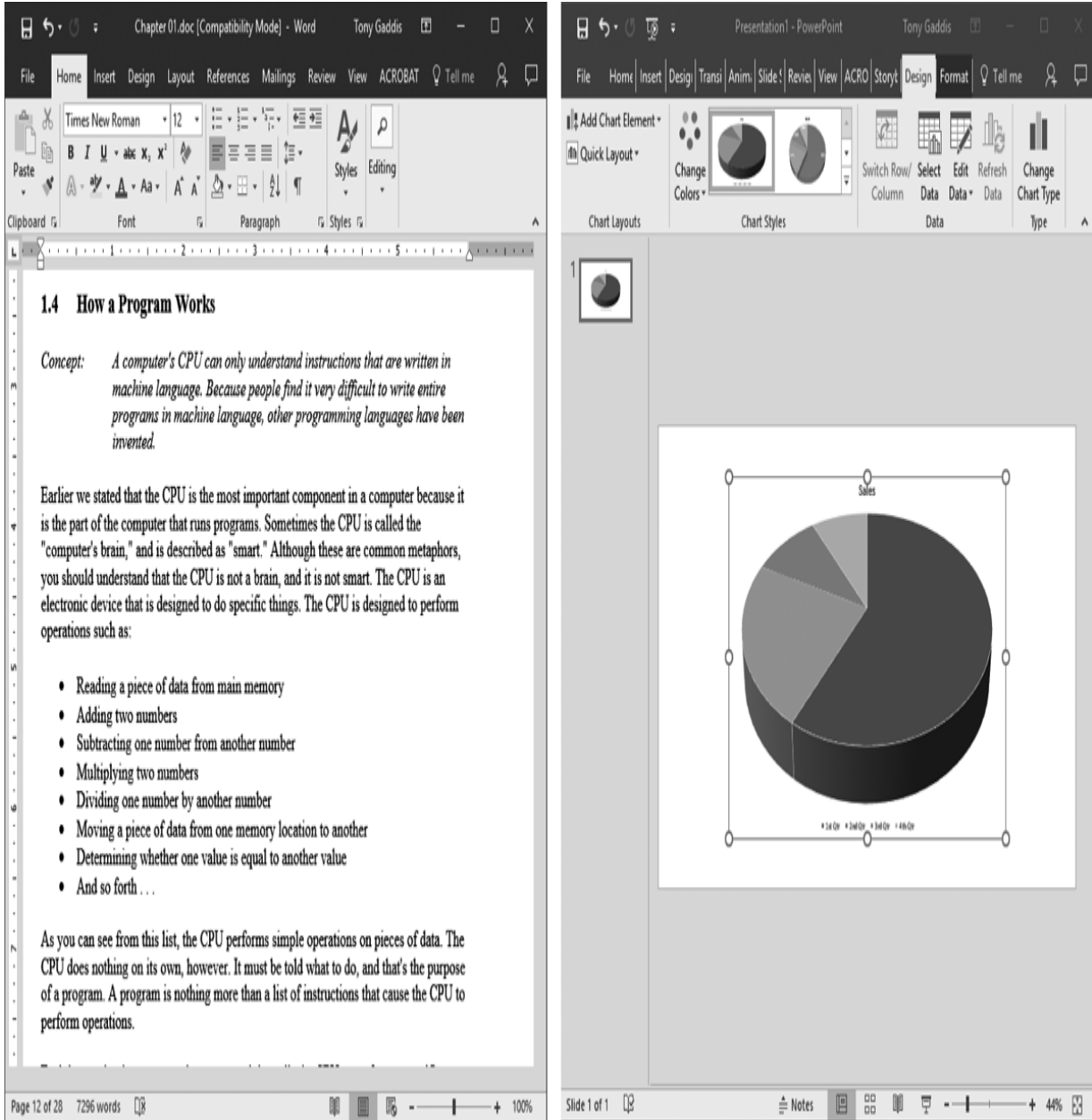
Think about some of the different ways that people use computers. In school, students use computers for tasks such as writing papers, searching for articles, sending e-mail, and participating in online classes. At work, people use computers to conduct business transactions, communicate with customers and coworkers, analyze data, make presentations, control machines in manufacturing facilities, and many many other tasks. At home, people use computers for tasks such as paying bills, shopping online, social networking, and playing computer games. And don't forget that smartphones, MP3 players, DVRs, car navigation systems, and many other devices are computers as well. The uses of computers are almost limitless in our everyday lives.

Computers can do such a wide variety of things because they can be programmed. This means computers are not designed to do just one job, but any job that their programs tell them to do. A *program* is a



set of instructions that a computer follows to perform a task. For example, **Figure 1-1** shows screens using Microsoft Word and PowerPoint, two commonly used programs.

**Figure 1-1 A word processing program and a presentation program**



Programs are commonly referred to as *software*. Software is essential to a computer because without software, a computer can do nothing. All of the software we use to make our computers useful is created by individuals known as programmers or software developers. A *programmer*, or *software developer*, is a person with the training and skills necessary to design, create, and test computer programs. Computer programming is an exciting and rewarding career. Today, you will find programmers working in business, medicine, government, law enforcement, agriculture, academia, entertainment, and almost every other field.

Computer programming is both an art and a science. It is an art because every aspect of a program should be carefully designed. Listed below are a few of the things that must be designed for any real-world computer program:

- The logical flow of the instructions
- The mathematical procedures
- The appearance of the screens
- The way information is presented to the user
- The program's "user-friendliness"
- Documentation, help files, tutorials, and so on

There is also a scientific, or engineering, side to programming. Because programs rarely work right the first time they are written, a lot of testing, correction, and redesigning is required. This demands patience and persistence from the programmer. Writing software demands discipline as well. Programmers must learn special

languages like C++ because computers do not understand English or other human languages. Languages such as C++ have strict rules that must be carefully followed.

Both the artistic and scientific nature of programming make writing computer software like designing a car: Both cars and programs should be functional, efficient, powerful, easy to use, and pleasing to look at.

## 1.2 Computer Systems: Hardware and Software

**Concept:**

All computer systems consist of similar hardware devices and software components. This section provides an overview of standard computer hardware and software organization.

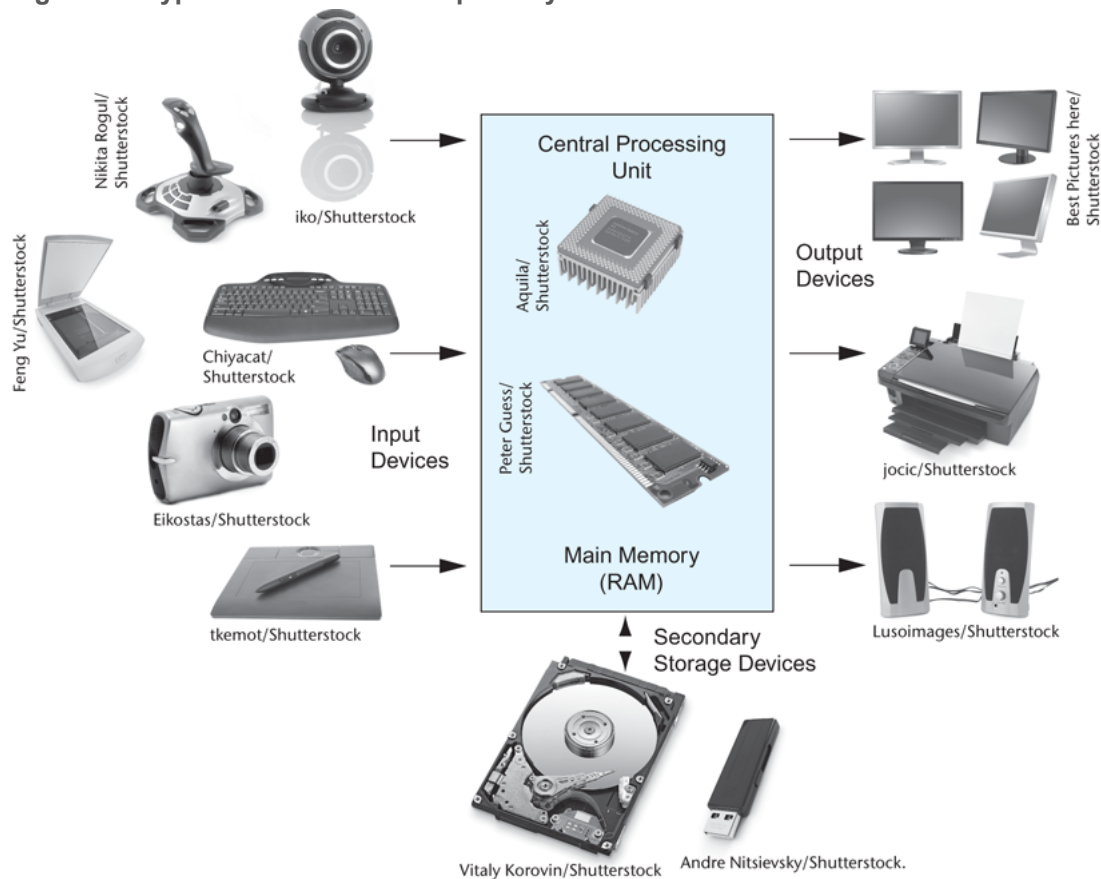
# Hardware

*Hardware* refers to the physical components of which a computer is made. A computer, as we generally think of it, is not an individual device, but a system of devices. Like the instruments in a symphony orchestra, each device plays its own part. A typical computer system consists of the following major components:

- The central processing unit (CPU)
- Main memory
- Secondary storage devices
- Input devices
- Output devices


The organization of a computer system is depicted in [Figure 1-2](#).

**Figure 1-2 Typical devices in a computer system**



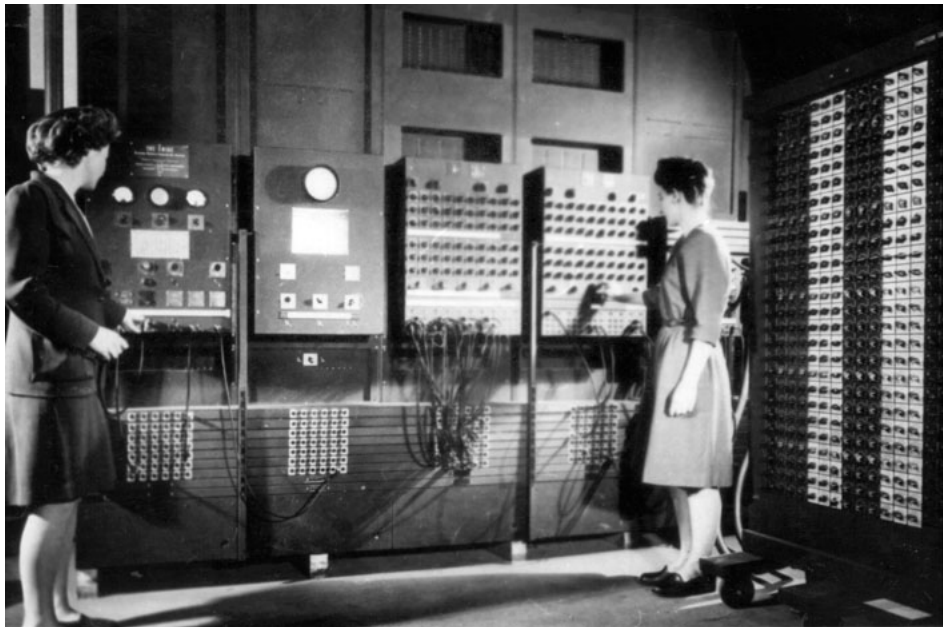
## The CPU


When a computer is performing the tasks that a program tells it to do, we say that the computer is *running* or *executing* the program. The *central processing unit*, or *CPU*, is the part of a computer that actually runs programs. The CPU is the most important component in a computer because without it, the computer could not run software.

In the earliest computers, CPUs were huge devices made of electrical and mechanical components such as vacuum tubes and switches. **Figure 1-3**  shows such a device. The two women in the photo are working with the historic ENIAC computer. The *ENIAC*, considered by many to be the world's first programmable electronic computer, was built in 1945 to calculate artillery ballistic tables for the U.S. Army. This machine, which was primarily one big CPU, was 8 feet tall, 100 feet long, and weighed 30 tons.

**Figure 1-3 The ENIAC computer**

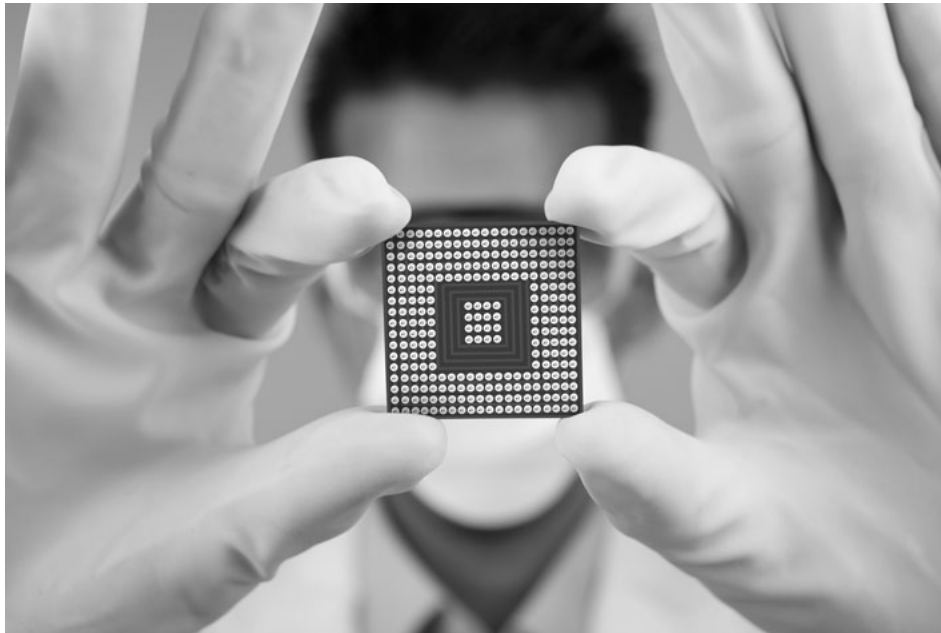
*U.S. Army Center of Military History*



Today, CPUs are small chips known as *microprocessors*. **Figure 1-4**  shows a photo of a lab technician holding a modern-day microprocessor. In addition to being much smaller than the old electromechanical CPUs in early computers, microprocessors are also much more powerful.

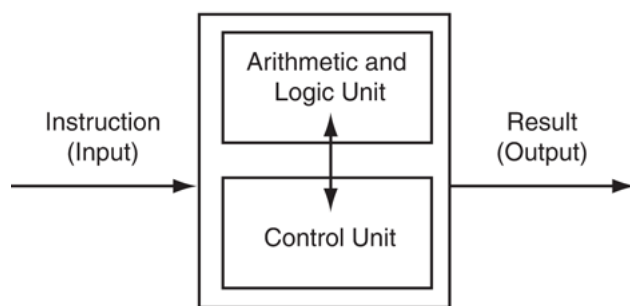
**Figure 1-4 A microprocessor**

*Creativa/Shutterstock*



The CPU's job is to fetch instructions, follow the instructions, and produce some result. Internally, the central processing unit consists of two parts: the *control unit* and the *arithmetic and logic unit (ALU)*. The control unit coordinates all of the computer's operations. It is responsible for determining where to get the next instruction and regulating the other major components of the computer with control signals. The arithmetic and logic unit, as its name suggests, is designed to perform mathematical operations. The organization of the CPU is shown in [Figure 1-5](#).

**Figure 1-5 Organization of a CPU**  
Central Processing Unit



A program is a sequence of instructions stored in the computer's memory. When a computer is running a program, the CPU is engaged in a process known formally as the *fetch/decode/execute cycle*. The steps in the fetch/decode/execute cycle are as follows:

These steps are repeated as long as there are instructions to perform.

## Main Memory

You can think of main memory as the computer's work area. This is where the computer stores a program while the program is running, as well as the data with which the program is working. For example, suppose you are using a word processing program to write an essay for one of your classes. While you do this, both the word processing program and the essay are stored in main memory.

Main memory is commonly known as *random-access memory* or *RAM*. It is called this because the CPU is able to quickly access data stored at any random location in RAM. RAM is usually a *volatile* type of memory that is used only for temporary storage while a program is running. When the computer is turned off, the contents of RAM are erased. Inside your computer, RAM is stored in small chips.

A computer's memory is divided into tiny storage locations known as bytes. One *byte* is enough memory to store only a letter of the alphabet or a small number. In order to do anything meaningful, a computer must have lots of bytes. Most computers today have millions, or even billions, of bytes of memory.

Each byte is divided into eight smaller storage locations known as bits. The term *bit* stands for *binary digit*. Computer scientists usually think of bits as tiny switches that can be either on or off. Bits aren't actual "switches," however, at least not in the conventional sense. In most computer systems, bits are tiny electrical components that can hold either a positive or a negative charge. Computer scientists think of a positive charge as a switch in the *on* position, and a negative charge as a switch in the *off* position.

Each byte is assigned a unique number known as an *address*. The addresses are ordered from lowest to highest. A byte is identified by its address in much the same way a post office box is identified by an address. [Figure 1-6](#) shows a group of memory cells with their addresses. In the illustration, sample data is stored in memory. The number 149 is stored in the cell with the address 16, and the number 72 is stored at address 23.

**Figure 1-6 Memory**

0	1	2	3	4	5	6	7	8	9	
10	11	12	13	14	15	16	149	17	18	19
20	21	22	23	72	24	25	26	27	28	29



## Secondary Storage

Secondary storage is a type of memory that can hold data for long periods of time, even when there is no power to the computer. Programs are normally stored in secondary memory and loaded into main memory as needed. Important data such as word processing documents, payroll data, and inventory records is saved to secondary storage as well.

The most common type of secondary storage device is the disk drive. A traditional *disk drive* stores data by magnetically encoding it onto a circular disk. *Solid-state drives*, which store data in solid-state memory, are increasingly becoming popular. A solid-state drive has no moving parts and operates faster than a traditional disk drive. Most computers have some sort of secondary storage device, either a traditional disk drive or a solid-state drive, mounted inside their case. External storage devices can be used to create backup copies of important data or to move data to another computer. For example, *USB (Universal Serial Bus) drives* and *SD (Secure Digital) memory cards* are small devices that appear in the system as disk drives. They are inexpensive, reliable, and small enough to be carried in your pocket.

Optical devices such as the *CD* (compact disc) and the *DVD* (digital versatile disc) are also used for data storage. Data is not recorded magnetically on an optical disc, but is encoded as a series of pits on the disc surface. CD and DVD drives use a laser to detect the pits and thus read the encoded data. Optical discs hold large amounts of data, and because recordable CD and DVD drives are now commonplace, they are good mediums for creating backup copies of data.

## Input Devices

*Input* is any data the computer collects from the outside world. The device that collects the information and sends it to the computer is called an *input device*. Common input devices are the keyboard, mouse, touchscreen, scanner, digital camera, and microphone. Disk drives, CD/DVD drives, and USB drives can also be considered input devices because programs and information are retrieved from them and loaded into the computer's memory.

## Output Devices

Output is any information the computer sends to the outside world. It might be a sales report, a list of names, or a graphic image. The information is sent to an *output device*, which formats and presents it. Common output devices are screens, printers, and speakers. Storage devices can also be considered output devices because the CPU sends them data to be saved.

# Software

If a computer is to function, software is not optional. Everything a computer does, from the time you turn the power switch on until you shut the system down, is under the control of software. There are two general categories of software: system software and application software. Most computer programs clearly fit into one of these two categories. Let's take a closer look at each.

## *System Software*

The programs that control and manage the basic operations of a computer are generally referred to as *system software*. System software typically includes the following types of programs:

- **Operating Systems**

An *operating system* is the most fundamental set of programs on a computer. The operating system controls the internal operations of the computer's hardware, manages all the devices connected to the computer, allows data to be saved to and retrieved from storage devices, and allows other programs to run on the computer.

- **Utility Programs**

A *utility program* performs a specialized task that enhances the computer's operation or safeguards data. Examples of utility programs are virus scanners, file-compression programs, and data-backup programs.

- **Software Development Tools**

The software tools that programmers use to create, modify, and test software are referred to as *software development tools*. Compilers and integrated development environments, which we will discuss later in this chapter, are examples of programs that fall into this category.

## Application Software

Programs that make a computer useful for everyday tasks are known as *application software*. These are the programs that people normally spend most of their time running on their computers. [Figure 1-1](#), at the beginning of this chapter, shows screens from two commonly used applications—Microsoft Word, a word processing program, and Microsoft PowerPoint, a presentation program. Some other examples of application software are spreadsheet programs, e-mail programs, web browsers, and game programs.

### Checkpoint

- 1.1 Why is the computer used by so many different people, in so many different professions?
- 1.2 List the five major hardware components of a computer system.
- 1.3 Internally, the CPU consists of what two units?
- 1.4 Describe the steps in the fetch/decode/execute cycle.
- 1.5 What is a memory address? What is its purpose?
- 1.6 Explain why computers have both main memory and secondary storage.
- 1.7 What are the two general categories of software?
- 1.8 What fundamental set of programs control the internal operations of the computer's hardware?
- 1.9 What do you call a program that performs a specialized task, such as a virus scanner, a file-compression program, or a data-backup program?
- 1.10 Word processing programs, spreadsheet programs, e-mail programs, web browsers, and game programs belong to what category of software?

## 1.3 Programs and Programming Languages

**Concept:**

A program is a set of instructions a computer follows in order to perform a task. A programming language is a special language used to write computer programs.

# What Is a Program?

Computers are designed to follow instructions. A computer program is a set of instructions that tells the computer how to solve a problem or perform a task. For example, suppose we want the computer to calculate someone's gross pay. Here is a list of things the computer should do:

1. Display a message on the screen asking "How many hours did you work?"
2. Wait for the user to enter the number of hours worked. Once the user enters a number, store it in memory.
3. Display a message on the screen asking "How much do you get paid per hour?"
4. Wait for the user to enter an hourly pay rate. Once the user enters a number, store it in memory.
5. Multiply the number of hours by the amount paid per hour, and store the result in memory.
6. Display a message on the screen that tells the amount of money earned. The message must include the result of the calculation performed in Step 5.

Collectively, these instructions are called an *algorithm*. An algorithm is a set of well-defined steps for performing a task or solving a problem. Notice these steps are sequentially ordered. Step 1 should be performed before Step 2, and so forth. It is important that these instructions be performed in their proper sequence.

Although you and I might easily understand the instructions in the pay-calculating algorithm, it is not ready to be executed on a computer. A computer's CPU can only process instructions that are written in *machine language*. If you were to look at a machine language program, you would see a stream of *binary numbers* (numbers consisting of only 1s and 0s). The binary numbers form machine language instructions, which the CPU interprets as commands. Here is an example of what a machine language instruction might look like:

```
1011010000000101
```

As you can imagine, the process of encoding an algorithm in machine language is very tedious and difficult. In addition, each different type of CPU has its own machine language. If you wrote a machine language program for computer *A* then wanted to run it on computer *B*, which has a different type of CPU, you would have to rewrite the program in computer *B*'s machine language.

*Programming languages*, which use words instead of numbers, were invented to ease the task of programming. A program can be written in a programming language, such as C++, which is much easier to understand than machine language. Programmers save their programs in text files, then use special software to convert their programs to machine language.

**Program 1-1**  shows how the pay-calculating algorithm might be written in C++.

## Program 1-1

```
1 // This program calculates the user's pay.
2 #include <iostream>
3 using namespace std;
4
5 int main()
6 {
7     double hours, rate, pay;
8
9     // Get the number of hours worked.
10    cout << "How many hours did you work? ";
11    cin >> hours;
12
13    // Get the hourly pay rate.
14    cout << "How much do you get paid per hour? ";
15    cin >> rate;
16
17    // Calculate the pay.
18    pay = hours * rate;
19
20    // Display the pay.
21    cout << "You have earned $" << pay << endl;
22    return 0;
23 }
```


### Program Output with Example Input Shown in Bold

```
How many hours did you work? 10 Enter
How much do you get paid per hour? 15 Enter
You have earned $150
```

The “Program Output with Example Input” shows what the program will display on the screen when it is running. In the example, the user enters 10 for the number of hours worked and 15 for the hourly pay rate. The program displays the earnings, which are \$150.



**Note:**

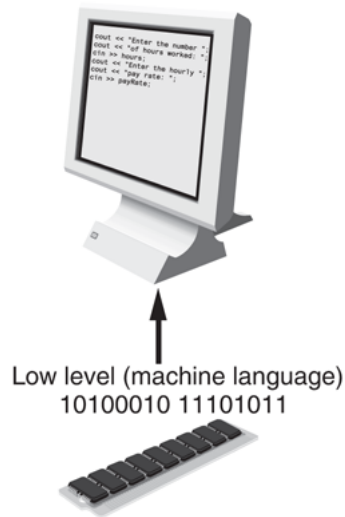
The line numbers that are shown in **Program 1-1**  are *not* part of the program. This book shows line numbers in all program listings to help point out specific parts of the program.

# Programming Languages

In a broad sense, there are two categories of programming languages: low-level and high-level. A low-level language is close to the level of the computer, which means it resembles the numeric machine language of the computer more than the natural language of humans. The easiest languages for people to learn are *high-level languages*. They are called “high-level” because they are closer to the level of human readability than computer readability. [Figure 1-7](#) illustrates the concept of language levels.

**Figure 1-7 Low-level versus high-level languages**

High level (easily understood by humans)



Many high-level languages have been created. [Table 1-1](#) lists a few of the well-known ones.

**Table 1-1 Programming Languages**

In addition to the high-level features necessary for writing applications such as payroll systems and inventory programs, C++ also has many low-level features. C++ is based on the C language, which was invented for purposes such as writing operating systems and compilers. Since C++ evolved from C, it carries all of C’s low-level capabilities with it.

C++ is popular not only because of its mixture of low- and high-level features, but also because of its *portability*. This means that a C++ program can be written on one type of computer, then run on many other types of systems. This usually requires the program to be recompiled on each type of system, but the program itself may need little or no change.





**Note:**

Programs written for specific graphical environments often require significant changes when moved to a different type of system. Examples of such graphical environments are Windows, the X-Window System, and the macOS operating system.

# Source Code, Object Code, and Executable Code

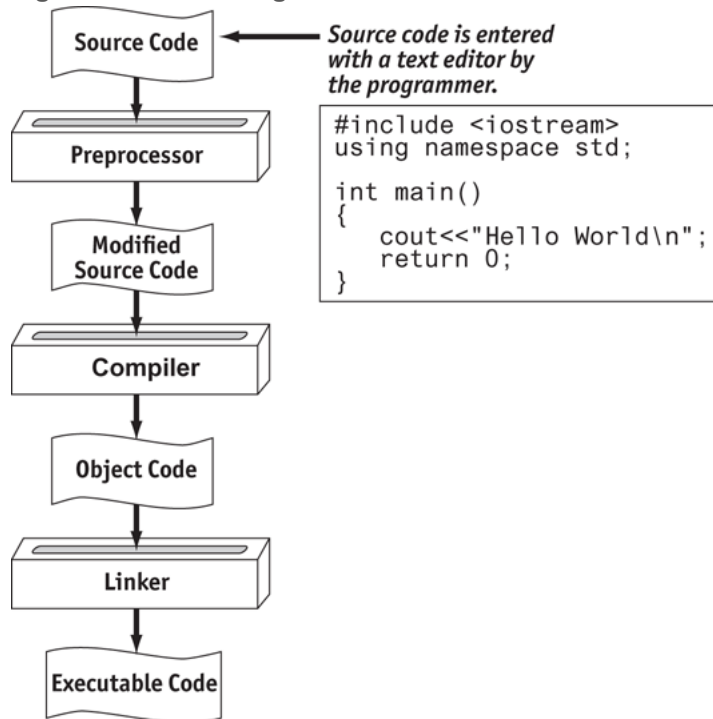
When a C++ program is written, it must be typed into the computer and saved to a file. A *text editor*, which is similar to a word processing program, is used for this task. The statements written by the programmer are called *source code*, and the file they are saved in is called the *source file*.

After the source code is saved to a file, the process of translating it to machine language can begin. During the first phase of this process, a program called the *preprocessor* reads the source code. The preprocessor searches for special lines that begin with the `#` symbol. These lines contain commands that cause the preprocessor to modify the source code in some way. During the next phase, the *compiler* steps through the preprocessed source code, translating each source code instruction into the appropriate machine language instruction. This process will uncover any *syntax errors* that may be in the program. Syntax errors are illegal uses of key words, operators, punctuation, and other language elements. If the program is free of syntax errors, the compiler stores the translated machine language instructions, which are called *object code*, in an *object file*.

Although an object file contains machine language instructions, it is not a complete program. Here is why: C++ is conveniently equipped with a library of prewritten code for performing common operations or sometimes-difficult tasks. For example, the library contains hardware-specific code for displaying messages on the screen and reading input from the keyboard. It also provides routines for mathematical functions, such as calculating the square root of a number. This collection of code, called the *runtime library*, is extensive. Programs almost always use some part of it. When the compiler generates an object file, however, it does not include machine code for any runtime library routines the programmer might have used. During the last phase of the translation process, another program called the *linker* combines the object file with the necessary library routines. Once the linker has finished with this step, an *executable file* is created. The executable file contains machine language instructions, or *executable code*, and is ready to run on the computer.

**Figure 1-8**  illustrates the process of translating a C++ source file into an executable file.

Figure 1-8 Translating a C++ source file to an executable file



The entire process of invoking the preprocessor, compiler, and linker can be initiated with a single action. For example, on a Linux system, the following command causes the C++ program named `hello.cpp` to be preprocessed, compiled, and linked. The executable code is stored in a file named `hello`.

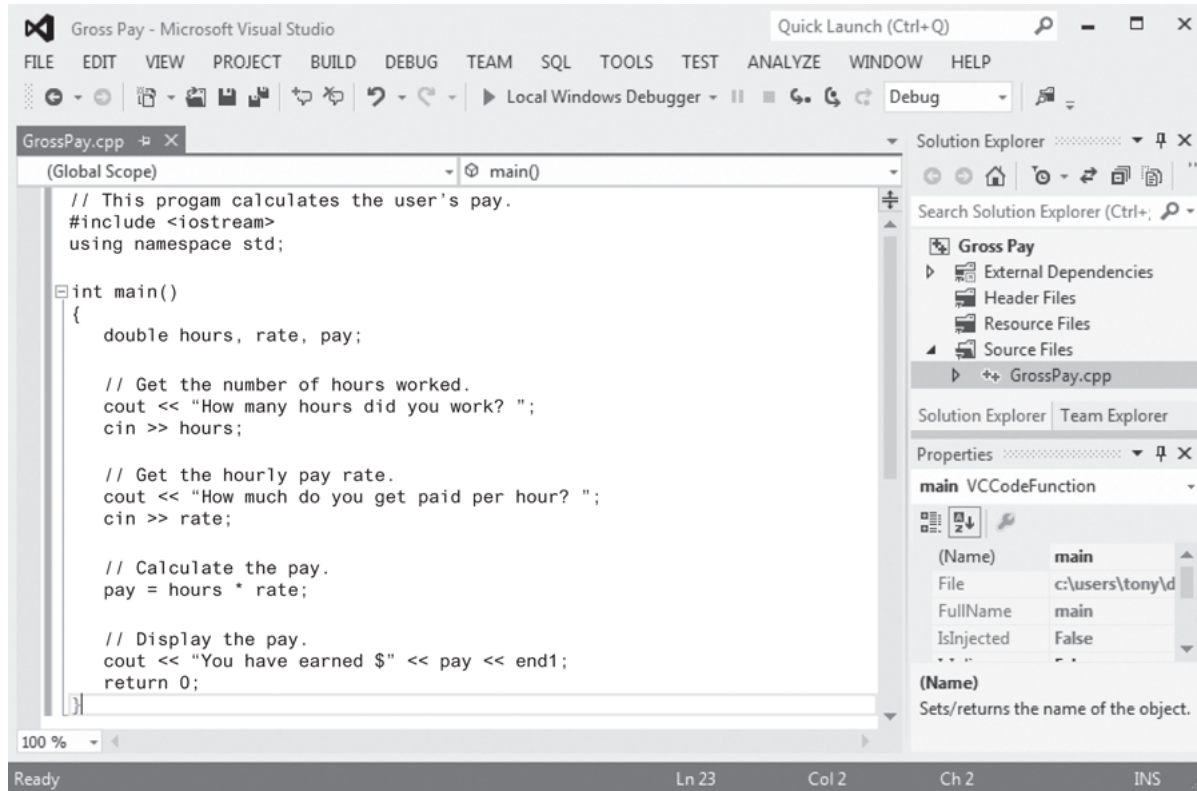
```
g++ -o hello hello.cpp
```

Appendix F explains how compiling works in .Net. You can download Appendix F from the Computer Science Portal at [www.pearsonhighered.com/gaddis](http://www.pearsonhighered.com/gaddis).

Many development systems, particularly those on personal computers, have *integrated development environments (IDEs)*. These environments consist of a text editor, compiler, debugger, and other utilities integrated into a package with a single set of menus. Preprocessing, compiling, linking, and even executing a program is done with a single click of a button, or by selecting a single item from a menu.

**Figure 1-9** shows a screen from the Microsoft Visual Studio IDE.

Figure 1-9 An integrated development environment (IDE)



## Checkpoint

- 1.11 What is an algorithm?
- 1.12 Why were computer programming languages invented?
- 1.13 What is the difference between a high-level language and a low-level language?
- 1.14 What does *portability* mean?
- 1.15 Explain the operations carried out by the preprocessor, compiler, and linker.
- 1.16 Explain what is stored in a source file, an object file, and an executable file.
- 1.17 What is an integrated development environment?

## 1.4 What Is a Program Made of?

**Concept:**

There are certain elements that are common to all programming languages.

# Language Elements

All programming languages have a few things in common. [Table 1-2](#) lists the common elements you will find in almost every language.

## Table 1-2 Language Elements

Let's look at some specific parts of [Program 1-1](#) (the pay-calculating program) to see examples of each element listed in the table above. For your convenience, [Program 1-1](#) is listed again.

## Program 1-1

```
1 // This program calculates the user's pay.
2 #include <iostream>
3 using namespace std;
4
5 int main()
6 {
7     double hours, rate, pay;
8
9     // Get the number of hours worked.
10    cout << "How many hours did you work? ";
11    cin >> hours;
12
13    // Get the hourly pay rate.
14    cout << "How much do you get paid per hour?
15";
16    cin >> rate;
17
18    // Calculate the pay.
19    pay = hours * rate;
20
21    // Display the pay.
22    cout << "You have earned $" << pay << endl;
```

```
22     return 0;
```

```
23 }
```



## Key Words (Reserved Words)

Three of C++'s key words appear on lines 3 and 5: `using`, `namespace`, and `int`. The word `double`, which appears on line 7, is also a C++ key word. These words, which are always written in lowercase, each have a special meaning in C++ and can only be used for their intended purposes. As you will see, the programmer is allowed to make up his or her own names for certain things in a program. Key words, however, are reserved and cannot be used for anything other than their designated purposes. Part of learning a programming language is learning what the key words are, what they mean, and how to use them.



### Note:

The `#include <iostream>` statement in line 2 is a preprocessor directive.



### Note:

In C++, key words are written in all lowercase.

## Programmer-Defined Identifiers

The words `hours`, `rate`, and `pay` that appear in the program on lines 7, 11, 15, 18, and 21 are programmer-defined identifiers. They are not part of the C++ language, but rather are names made up by the programmer. In this particular program, these are the names of variables. As you will learn later in this chapter, variables are the names of memory locations that may hold data.

## Operators

On line 18 the following code appears:


```
pay = hours * rate;
```


The `=` and `*` symbols are both operators. They perform operations on pieces of data known as operands. The `*` operator multiplies its two operands, which in this example are the variables `hours` and `rate`. The `=` symbol is called the assignment operator. It takes the value of the expression on the right and stores it in the variable whose name appears on the left. In this example, the `=` operator stores in the `pay` variable the result of the `hours` variable multiplied by the `rate` variable. In other words, the statement says, “Make the `pay` variable equal to `hours` times `rate`, or “`pay` is assigned the value of `hours` times `rate`.”

## *Punctuation*

Notice lines 3, 7, 10, 11, 14, 15, 18, 21, and 22 all end with a semicolon. A semicolon in C++ is similar to a period in English: It marks the end of a complete sentence (or statement, as it is called in programming jargon). Semicolons do not appear at the end of every line in a C++ program, however. There are rules that govern where semicolons are required and where they are not. Part of learning C++ is learning where to place semicolons and other punctuation symbols.

# Lines and Statements

Often, the contents of a program are thought of in terms of lines and statements. A “line” is just that—a single line as it appears in the body of a program. **Program 1-1**  has 23 lines. Most of the lines contain something meaningful; however, some of the lines are empty. The blank lines are only there to make the program more readable.

A statement is a complete instruction that causes the computer to perform some action. Here is the statement that appears in line 10 of **Program 1-1** .

```
cout << "How many hours did you work? ";
```

This statement causes the computer to display the message “How many hours did you work?” on the screen. Statements can be a combination of key words, operators, and programmer-defined symbols. Statements often occupy only one line in a program, but sometimes they are spread out over more than one line.

# Variables

A variable is a named storage location in the computer's memory for holding a piece of information. The information stored in variables may change while the program is running (hence the name "variable"). Notice in [Program 1-1](#) the words `hours`, `rate`, and `pay` appear in several places. All three of these are the names of variables. The `hours` variable is used to store the number of hours the user has worked. The `rate` variable stores the user's hourly pay rate. The `pay` variable holds the result of `hours` multiplied by `rate`, which is the user's gross pay.



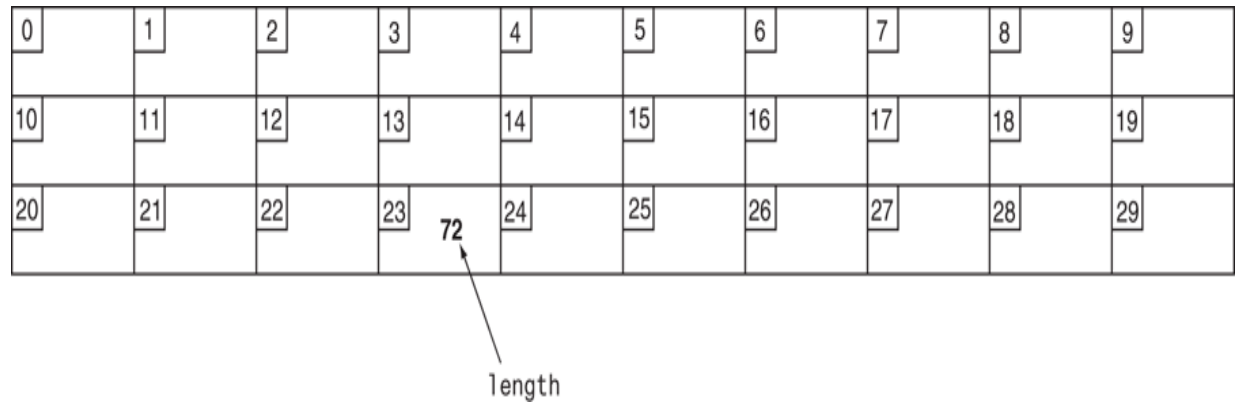
## **Note:**

Notice the variables in [Program 1-1](#) have names that reflect their purpose. In fact, it would be easy to guess what the variables were used for just by reading their names. This will be discussed further in [Chapter 2](#).

Variables are symbolic names that represent locations in the computer's random-access memory (RAM). When information is stored in a variable, it is actually stored in RAM. Assume a program

has a variable named `length`. **Figure 1-10** illustrates the way the variable name represents a memory location.

**Figure 1-10 A variable name represents a memory location**



In **Figure 1-10**, the variable `length` is holding the value 72. The number 72 is actually stored in RAM at address 23, but the name `length` symbolically represents this storage location. If it helps, you can think of a variable as a box that holds information. In **Figure 1-10**, the number 72 is stored in the box named `length`. Only one item may be stored in the box at any given time. If the program stores another value in the box, it will take the place of the number 72.

# Variable Definitions


In programming, there are two general types of data: numbers and characters. Numbers are used to perform mathematical operations, and characters are used to print data on the screen or on paper.

Numeric data can be categorized even further. For instance, the following are all whole numbers or integers:

```
5  
7  
-129  
32154
```

The following are real or floating-point numbers:

```
3.14159  
6.7  
1.0002
```

When creating a variable in a C++ program, you must know what type of data the program will be storing in it. Look at line 7 of [Program 1-1](#) :

```
double hours, rate, pay;
```

The word `double` in this statement indicates that the variables `hours`, `rate`, and `pay` will be used to hold double precision floating-point numbers. This statement is called a *variable definition*. It is used to *define* one or more variables that will be used in the program and to indicate the type of data they will hold. The variable definition causes the variables to be created in memory, so all variables must be defined before they can be used. If you review the listing of [Program 1-1](#), you will see that the variable definitions come before any other statements using those variables.



**Note:**


Programmers often use the term “variable declaration” to mean the same thing as “variable definition.” Strictly speaking, there is a difference between the two terms. A definition statement always causes a variable to be created in memory. Some types of declaration statements, however, do not cause a variable to be created in memory. You will learn more about declarations later in this book.



# 1.5 Input, Processing, and Output

## Concept:

The three primary activities of a program are input, processing, and output.

Computer programs typically perform a three-step process of gathering input, performing some process on the information gathered, then producing output. Input is information a program collects from the outside world. It can be sent to the program from the user, who is entering data at the keyboard or using the mouse. It can also be read from disk files or hardware devices connected to the computer. [Program 1-1](#)  allows the user to enter two pieces of information: the number of hours worked and the hourly pay rate. Lines 11 and 15 use the `cin` (pronounced “see in”) object to perform these input operations:

```
cin >> hours;  
cin >> rate;
```

Once information is gathered from the outside world, a program usually processes it in some manner. In [Program 1-1](#), the hours worked and hourly pay rate are multiplied in line 18, and the result is assigned to the `pay` variable:

```
pay = hours * rate;
```

Output is information that a program sends to the outside world. It can be words or graphics displayed on a screen, a report sent to the printer, data stored in a file, or information sent to any device connected to the computer. Lines 10, 14, and 21 in [Program 1-1](#) all perform output:

```
cout << "How many hours did you work? ";  
cout << "How much do you get paid per hour? ";  
cout << "You have earned $" << pay << endl;
```

These lines use the `cout` (pronounced “see out”) object to display messages on the computer’s screen. You will learn more details about the `cin` and `cout` objects in [Chapter 2](#).



# Checkpoint

- 1.18 Describe the difference between a key word and a programmer-defined identifier.
- 1.19 Describe the difference between operators and punctuation symbols.
- 1.20 Describe the difference between a program line and a statement.
- 1.21 Why are variables called “variable”?
- 1.22 What happens to a variable’s current contents when a new value is stored there?
- 1.23 What must take place in a program before a variable is used?
- 1.24 What are the three primary activities of a program?

## 1.6 The Programming Process

**Concept:**

The programming process consists of several steps, which include design, creation, testing, and debugging activities.

# Designing and Creating a Program

Now that you have been introduced to what a program is, it's time to consider the process of creating a program. Quite often, when inexperienced students are given programming assignments, they have trouble getting started because they don't know what to do first. If you find yourself in this dilemma, the steps listed in [Figure 1-11](#) may help. These are the steps recommended for the process of writing a program.

**Figure 1-11 Steps for writing a program**

1. Clearly define what the program is to do.
2. Visualize the program running on the computer.
3. Use design tools such as a hierarchy chart, flowcharts, or pseudocode to create a model of the program.
4. Check the model for logical errors.
5. Type the code, save it, and compile it.
6. Correct any errors found during compilation. Repeat Steps 5 and 6 as many times as necessary.
7. Run the program with test data for input.
8. Correct any errors found while running the program. Repeat Steps 5 through 8 as many times as necessary.
9. Validate the results of the program.

The steps listed in [Figure 1-11](#) emphasize the importance of planning. Just as there are good ways and bad ways to paint a house, there are good ways and bad ways to create a program. A good program always begins with planning.

With the pay-calculating program as our example, let's look at each of the steps in more detail.

**1. Clearly define what the program is to do.**

This step requires that you identify the purpose of the program, the information that is to be input, the processing that is to take place, and the desired output. Let's examine each of these requirements for the example program:

**2. Visualize the program running on the computer.**

Before you create a program on the computer, you should first create it in your mind. Step 2 is the visualization of the program. Try to imagine what the computer screen looks like while the program is running. If it helps, draw pictures of the screen, with sample input and output, at various points in the program. For instance, here is the screen produced by the pay-calculating program:

```
How many hours did you work? 10
How much do you get paid per hour? 15
You have earned $150
```

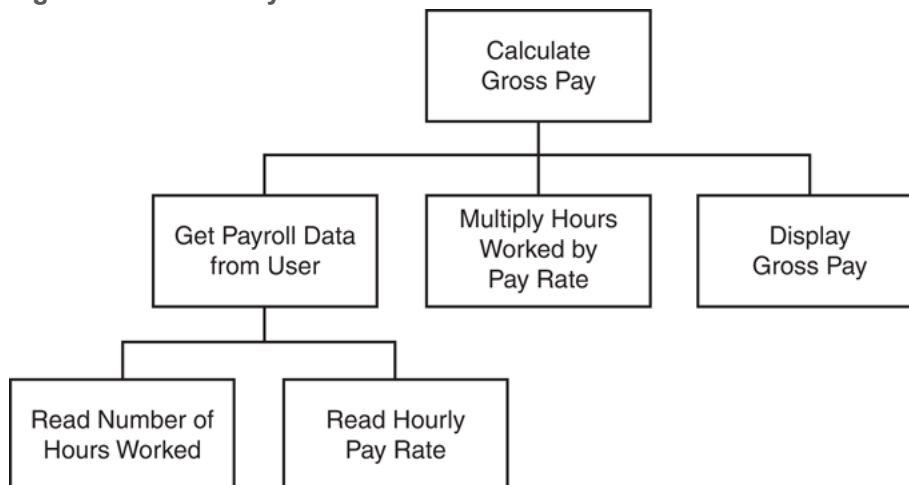
In this step, you must put yourself in the shoes of the user. What messages should the program display? What questions should it ask? By addressing these concerns, you will have already determined most of the program's output.

3. **Use design tools such as a hierarchy chart, flowcharts, or pseudocode to create a model of the program.**

While planning a program, the programmer uses one or more design tools to create a model of the program. Three common design tools are hierarchy charts, flowcharts, and pseudocode. A *hierarchy chart* is a diagram that graphically depicts the structure of a program. It has boxes that represent each step in the program. The boxes are connected in a way that illustrates their relationship to one another. [Figure 1-12](#) shows a hierarchy chart for the pay-calculating program.

A hierarchy chart begins with the overall task then refines it into smaller subtasks. Each of the subtasks is then refined into even smaller sets of subtasks, until each is small enough to be easily performed. For instance, in [Figure 1-12](#), the overall task "Calculate Gross Pay" is listed in the top-level box. That task is broken into three subtasks. The first subtask, "Get Payroll Data from User," is broken further into two subtasks. This process of "divide and conquer" is known as *top-down design*.

**Figure 1-12 Hierarchy chart**



A *flowchart* is a diagram that shows the logical flow of a program. It is a useful tool for planning each operation a program performs and the order in which the operations are to occur. For more information see Appendix C, Introduction to Flowcharting.



## Introduction to Flowcharting

*Pseudocode* is a cross between human language and a programming language. Although the computer can't understand pseudocode, programmers often find it helpful to write an algorithm in a language that's "almost" a programming language, but still very similar to natural language. For example, here is pseudocode that describes the pay-calculating program:

*Get payroll data.*

*Calculate gross pay.*

*Display gross pay.*



## Designing a Program with Pseudocode

Although the pseudocode above gives a broad view of the program, it doesn't reveal all the program's details. A more detailed version of the pseudocode follows:

*Display "How many hours did you work?"*

*Input hours.*

*Display "How much do you get paid per hour?"*

*Input rate.*

*Store the value of hours times rate in the pay variable.*

*Display the value in the pay variable.*

Notice the pseudocode contains statements that look more like commands than the English statements that describe the algorithm in [Section 1.4](#) (What Is a Program Made of?). The pseudocode even names variables and describes mathematical operations.

#### 4. Check the model for logical errors.

*Logical errors* are mistakes that cause the program to produce erroneous results. Once a hierarchy chart, flowchart, or pseudocode model of the program is assembled, it should be checked for these errors. The programmer should trace through the charts or pseudocode, checking the logic of each step. If an error is found, the model can be corrected before the next step is attempted.

**5. Type the code, save it, and compile it.**

Once a model of the program (hierarchy chart, flowchart, or pseudocode) has been created, checked, and corrected, the programmer is ready to write source code on the computer. The programmer saves the source code to a file and begins the process of translating it to machine language. During this step, the compiler will find any syntax errors that may exist in the program.

**6. Correct any errors found during compilation. Repeat Steps 5 and 6 as many times as necessary.**

If the compiler reports any errors, they must be corrected. Steps 5 and 6 must be repeated until the program is free of compile-time errors.

**7. Run the program with test data for input.**

Once an executable file is generated, the program is ready to be tested for runtime errors. A runtime error is an error that occurs while the program is running. These are usually logical errors, such as mathematical mistakes.

Testing for runtime errors requires that the program be executed with sample data or sample input. The sample data should be such that the correct output can be predicted. If the program does not produce the correct output, a logical error is present in the program.

**8. Correct any errors found while running the program. Repeat Steps 5 through 8 as many times as necessary.**

When runtime errors are found in a program, they must be corrected. You must identify the step where the error occurred and determine the cause. Desk-checking is a process that can help locate runtime errors. The term *desk-checking* means the programmer starts reading the program, or a portion of the program, and steps through each statement. A sheet of paper is often used in this process to jot down the current contents of all variables and sketch what the screen looks like after each output operation. When a variable's contents change, or information is displayed on the screen, this is noted. By stepping through each statement, many errors can be located and corrected. If an error is a result of incorrect logic (such as an improperly stated math formula), you must correct the statement or statements involved in the logic. If an error is due to an incomplete understanding of the program requirements, then you must restate the program purpose and modify the hierarchy and/or flowcharts, pseudocode, and source code. The program must then be saved, recompiled, and retested. This means Steps 5 through 8 must be repeated until the program reliably produces satisfactory results.

**9. Validate the results of the program.**

When you believe you have corrected all the runtime errors, enter test data and determine whether the program solves the original problem.



# What Is Software Engineering?

The field of software engineering encompasses the whole process of crafting computer software. It includes designing, writing, testing, debugging, documenting, modifying, and maintaining complex software development projects. Like traditional engineers, software engineers use a number of tools in their craft. Here are a few examples:

- Program specifications
- Charts and diagrams of screen output
- Hierarchy charts and flowcharts
- Pseudocode
- Examples of expected input and desired output
- Special software designed for testing programs

Most commercial software applications are very large. In many instances, one or more teams of programmers, not a single individual, develop them. It is important that the program requirements be thoroughly analyzed and divided into subtasks that are handled by individual teams, or individuals within a team.

In Step 3 of the programming process, you were introduced to the hierarchy chart as a tool for top-down design. The subtasks identified in a top-down design can easily become modules, or separate components of a program. If the program is very large or complex, a team of software engineers can be assigned to work on the individual modules. As the project develops, the modules are coordinated to finally become a single software application.

## 1.7 Procedural and Object-Oriented Programming

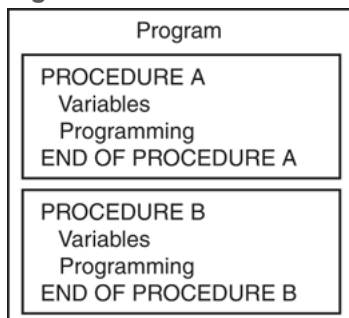
### Concept:

Procedural programming and object-oriented programming are two ways of thinking about software development and program design.

C++ is a language that can be used for two methods of writing computer programs: *procedural programming* and *object-oriented programming*. This book is designed to teach you some of both.

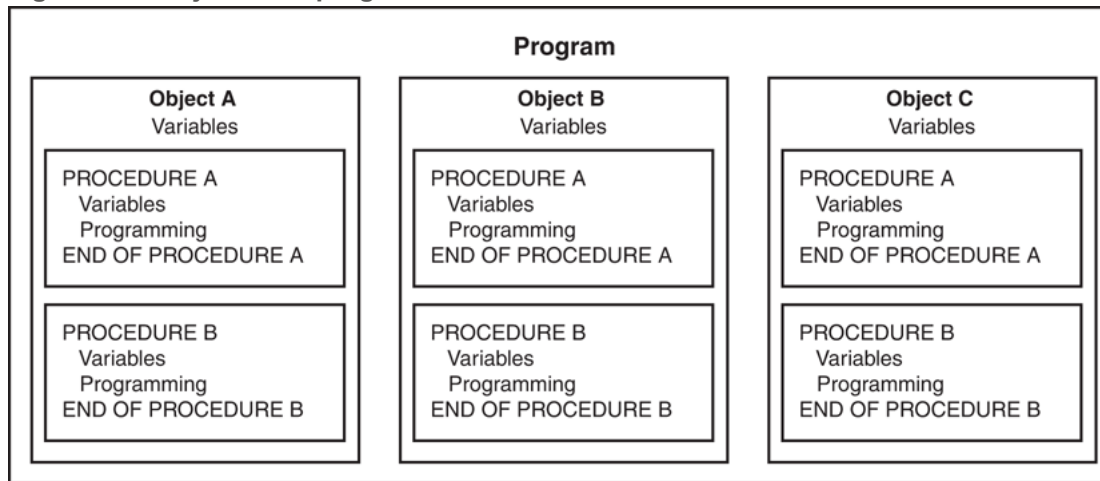
In procedural programming, the programmer constructs procedures (or functions, as they are called in C++). The procedures are collections of programming statements that perform a specific task. The procedures each contain their own variables and commonly share variables with other procedures. This is illustrated in [Figure 1-13](#).

**Figure 1-13 Procedures in a program**



Procedural programming is centered on the procedure, or function. Object-oriented programming (OOP), on the other hand, is centered on the object. An object is a programming element that contains data and the procedures that operate on the data. It is a self-contained unit. This is illustrated in [Figure 1-14](#).

Figure 1-14 Objects in a program



The objects contain, within themselves, both information and the ability to manipulate the information. Operations are carried out on the information in an object by sending the object a *message*. When an object receives a message instructing it to perform some operation, it carries out the instruction. As you study this text, you will encounter many other aspects of object-oriented programming.

## Checkpoint

- 1.25 What four items should you identify when defining what a program is to do?
- 1.26 What does it mean to “visualize a program running”? What is the value of such an activity?
- 1.27 What is a hierarchy chart?
- 1.28 Describe the process of desk-checking.
- 1.29 Describe what a compiler does with a program’s source code.
- 1.30 What is a runtime error?
- 1.31 Is a syntax error (such as misspelling a key word) found by the compiler or when the program is running?
- 1.32 What is the purpose of testing a program with sample data or input?
- 1.33 Briefly describe the difference between procedural and object-oriented programming.

# Review Questions and Exercises

## Short Answer

1. Both main memory and secondary storage are types of memory. Describe the difference between the two.
2. What is the difference between system software and application software?
3. What type of software controls the internal operations of the computer's hardware?
4. Why must programs written in a high-level language be translated into machine language before they can be run?
5. Why is it easier to write a program in a high-level language than in machine language?
6. Explain the difference between an object file and an executable file.
7. What is the difference between a syntax error and a logical error?

# Fill-in-the-Blank

8. Computers can do many different jobs because they can be \_\_\_\_.
9. The job of the \_\_\_\_ is to fetch instructions, carry out the operations commanded by the instructions, and produce some outcome or resultant information.
10. Internally, the CPU consists of the \_\_\_\_ and the \_\_\_\_.
11. A(n) \_\_\_\_ is an example of a secondary storage device.
12. The two general categories of software are \_\_\_\_ and \_\_\_\_.
13. A program is a set of \_\_\_\_.
14. Since computers can't be programmed in natural human language, algorithms must be written in a(n) \_\_\_\_ language.
15. \_\_\_\_ is the only language computers really process.
16. \_\_\_\_ languages are close to the level of humans in terms of readability.
17. \_\_\_\_ languages are close to the level of the computer.
18. A program's ability to run on several different types of computer systems is called \_\_\_\_.
19. Words that have special meaning in a programming language are called \_\_\_\_.
20. Words or names defined by the programmer are called \_\_\_\_.
21. \_\_\_\_ are characters or symbols that perform operations on one or more operands.
22. \_\_\_\_ characters or symbols mark the beginning or end of programming statements, or separate items in a list.

23. The rules that must be followed when constructing a program are called \_\_\_\_\_.
24. A(n) \_\_\_\_\_ is a named storage location.
25. A variable must be \_\_\_\_\_ before it can be used in a program.
26. The three primary activities of a program are \_\_\_\_\_, \_\_\_\_\_, and \_\_\_\_\_.
27. \_\_\_\_\_ is information a program gathers from the outside world.
28. \_\_\_\_\_ is information a program sends to the outside world.
29. A(n) \_\_\_\_\_ is a diagram that graphically illustrates the structure of a program.

# Algorithm Workbench

Draw hierarchy charts or flowcharts that depict the programs described below. (See Appendix C for instructions on creating flowcharts.)

## 30. Available Credit

The following steps should be followed in a program that calculates a customer's available credit:

1. Display the message "Enter the customer's maximum credit."
2. Wait for the user to enter the customer's maximum credit.
3. Display the message "Enter the amount of credit used by the customer."
4. Wait for the user to enter the customer's credit used.
5. Subtract the used credit from the maximum credit to get the customer's available credit.
6. Display a message that shows the customer's available credit.

## 31. Sales Tax

Design a hierarchy chart or flowchart for a program that calculates the total of a retail sale. The program should ask the user for:

- The retail price of the item being purchased
- The sales tax rate

Once these items have been entered, the program should calculate and display:

- The sales tax for the purchase
- The total of the sale

### 32. Account Balance

Design a hierarchy chart or flowchart for a program that calculates the current balance in a savings account. The program must ask the user for:



### **Designing the Account Balance Program**

- The starting balance
- The total dollar amount of deposits made
- The total dollar amount of withdrawals made
- The monthly interest rate

Once the program calculates the current balance, it should be displayed on the screen.



# Predict the Result

Questions 33–35 are programs expressed as English statements. What would each display on the screen if they were actual programs?



## Predicting the Result of Problem 33

33. The variable  $x$  starts with the value 0.  
The variable  $y$  starts with the value 5.  
Add 1 to  $x$ .  
Add 1 to  $y$ .  
Add  $x$  and  $y$ , and store the result in  $y$ .  
Display the value in  $y$  on the screen.
34. The variable  $j$  starts with the value 10.  
The variable  $k$  starts with the value 2.  
The variable  $l$  starts with the value 4.  
Store the value of  $j$  times  $k$  in  $j$ .  
Store the value of  $k$  times  $l$  in  $l$ .

Add `j` and `l`, and store the result in `k`.

Display the value in `k` on the screen.

35. The variable `a` starts with the value 1.

The variable `b` starts with the value 10.

The variable `c` starts with the value 100.

The variable `x` starts with the value 0.

Store the value of `c` times 3 in `x`.

Add the value of `b` times 6 to the value already in `x`.

Add the value of `a` times 5 to the value already in `x`.

Display the value in `x` on the screen.

# Find the Error

36. The following *pseudocode algorithm* has an error. The program is supposed to ask the user for the length and width of a rectangular room, then display the room's area. The program must multiply the width by the length in order to determine the area. Find the error.

*area = width × length.*

*Display "What is the room's width?"*.

*Input width.*

*Display "What is the room's length?"*.

*Input length.*

*Display area.*

---

# Chapter 2 Introduction to C++

---

## Topics

2.1 The Parts of a C++ Program [📄](#)

2.2 The `cout` Object [📄](#)

2.3 The `#include` Directive [📄](#)

2.4 Variables, Literals, and Assignment Statements [📄](#)

2.5 Identifiers [📄](#)

2.6 Integer Data Types [📄](#)

2.7 The `char` Data Type [📄](#)

2.8 The C++ `string` Class [📄](#)

2.9 Floating-Point Data Types [📄](#)

2.10 The `bool` Data Type [📄](#)

2.11 Determining the Size of a Data Type [📄](#)

**2.12 More about Variable Assignments and Initialization** 

**2.13 Scope** 

**2.14 Arithmetic Operators** 

**2.15 Comments** 


**2.16 Named Constants** 

**2.17 Programming Style** 

## 2.1 The Parts of a C++ Program

### **Concept:**

C++ programs have parts and components that serve specific purposes.

Every C++ program has an anatomy. Unlike human anatomy, the parts of C++ programs are not always in the same place. Nevertheless, the parts are there, and your first step in learning C++ is to learn what they are. We will begin by looking at [Program 2-1](#) .

## Program 2-1

```
1 // A simple C++ program
2 #include <iostream>
3 using namespace std;
4
5 int main()
6 {
7     cout << "Programming is great fun!";
8     return 0;
9 }
```


The output of the program is shown below. This is what appears on the screen when the program runs.

### Program Output

```
Programming is great fun!
```

Let's examine the program line by line. Here's the first line:

```
// A simple C++ program
```

The `//` marks the beginning of a *comment*. The compiler ignores everything from the double slash to the end of the line. That means you can type anything you want on that line and the compiler will never complain! Although comments are not required, they are very important to programmers. Most programs are much more complicated than the example in [Program 2-1](#) , and comments help explain what's going on.

Line 2 looks like this:

```
#include <iostream>
```

Because this line starts with a `#`, it is called a *preprocessor directive*. The preprocessor reads your program before it is compiled and only executes those lines beginning with a `#` symbol. Think of the preprocessor as a program that “sets up” your source code for the compiler.

The `#include` directive causes the preprocessor to include the contents of another file, known as a *header file*, in the program. It is called a header file because it should be included at the head, or top, of a program. The word that is enclosed in brackets, `iostream`, is the name of the header file that is to be included. (The name of the



file is `iostream`. The brackets `<>` indicate that it is a standard C++ header file.) The `<iostream>` header file contains code that allows a C++ program to display output on the screen and read input from the keyboard. Because this program uses `cout` to display screen output, the `<iostream>` header file must be included. The contents of the `<iostream>` file are included in the program at the point the `#include` statement appears.

Line 3 reads:

```
using namespace std;
```

Programs usually contain several items with unique names. In this chapter, you will learn to create variables. In [Chapter 6](#), you will learn to create functions. In [Chapter 13](#), you will learn to create objects. Variables, functions, and objects are examples of program entities that must have names. C++ uses *namespaces* to organize the names of program entities. The statement `using namespace std;` declares that the program will be accessing entities whose names are part of the namespace called `std`. (Yes, even namespaces have names.) The reason the program needs access to the `std` namespace is because every name created by the `iostream` file is part of that namespace. In order for a program to use the entities in `iostream`, it must have access to the `std` namespace.

Line 5 reads:

```
int main()
```

This marks the beginning of a function. A *function* can be thought of as a group of one or more programming statements that collectively has a name. The name of this function is *main*, and the set of parentheses that follows the name indicate that it is a function. The word `int` stands for “integer.” It indicates that the function sends an integer value back to the operating system when it is finished executing.

Although most C++ programs have more than one function, every C++ program must have a function called `main`. It is the starting point of the program. If you are ever reading someone else’s C++ program and want to find where it starts, just look for the function named `main`.



## Note:

C++ is a case-sensitive language. That means it regards uppercase letters as being entirely different characters than their lowercase counterparts. In C++, the name of the function `main` must be written in all lowercase letters. C++ doesn't see "Main" the same as "main," or "INT" the same as "int." This is true for all the C++ key words.

Line 6 contains a single, solitary character:

```
{
```

This is called a left brace, or an opening brace, and it is associated with the beginning of the function `main`. All the statements that make up a function are enclosed in a set of braces. If you look at the third line down from the opening brace, you'll see the closing brace. Everything between the two braces is the content of the function `main`.



## Warning!

Make sure you have a closing brace for every opening brace in your program!

After the opening brace, you see the following statement in line 7:

```
cout << "Programming is great fun!";
```

To put it simply, this line displays a message on the screen. You will read more about `cout` and the `<<` operator later in this chapter. The message “Programming is great fun!” is printed without the quotation marks. In programming terms, the group of characters inside the quotation marks is called a *string literal* or *string constant*.



## Note:

This is the only line in the program that causes anything to be printed on the screen. The other lines, like `#include` `<iostream>` and `int main()`, are necessary for the framework of your program, but they do not cause any screen output. Remember, a program is a set of instructions for the computer. If something is to be displayed on the screen, you must use a programming statement for that purpose.

At the end of the line is a semicolon. Just as a period marks the end of a sentence, a semicolon marks the end of a complete statement in C++. Comments are ignored by the compiler, so the semicolon isn't required at the end of a comment. Preprocessor directives, like `#include` statements, simply end at the end of the line and never require semicolons. The beginning of a function, like `int main()`, is not a complete statement, so you don't place a semicolon there either.

It might seem that the rules for where to put a semicolon are not clear at all. Rather than worry about it now, just concentrate on learning the parts of a program. You'll soon get a feel for where you should and should not use semicolons.

Line 8 reads:

```
return 0;
```

This sends the integer value 0 back to the operating system upon the program's completion. The value 0 usually indicates that a program executed successfully.

Line 9 contains the closing brace:

```
}
```

This brace marks the end of the `main` function. Since `main` is the only function in this program, it also marks the end of the program.

In the sample program, you encountered several sets of special characters. [Table 2-1](#) provides a short summary of how they were used.

## Table 2-1 Special Characters

# Checkpoint

2.1 The following C++ program will not compile because the lines have been mixed up.

```
int main()
}
// A crazy mixed up program
return 0;
#include <iostream>
cout << "In 1492 Columbus sailed the ocean blue.";
{
using namespace std;
```

When the lines are properly arranged, the program should display the following on the screen:

```
In 1492 Columbus sailed the ocean blue.
```

Rearrange the lines in the correct order. Test the program by entering it on the computer, compiling it, and running it.

## 2.2 The `cout` Object

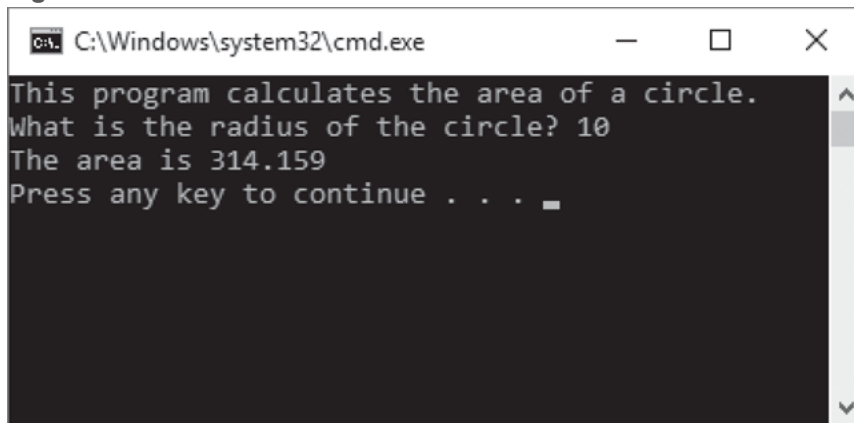
### Concept:

Use the `cout` object to display information on the computer's screen.

In this section, you will learn to write programs that produce output on the screen. The simplest type of screen output that a program can display is *console output*, which is merely plain text. The word *console* is an old computer term. It comes from the days when a computer operator interacted with the system by typing on a terminal. The terminal, which consisted of a simple screen and keyboard, was known as the *console*.

On modern computers, running graphical operating systems such as Windows or Mac OS X, console output is usually displayed in a window such as the one shown in [Figure 2-1](#). In C++, you use the `cout` object to produce console output. (You can think of the word `cout` as meaning **console output**.)

Figure 2-1 A console window



`cout` is classified as a *stream object*, which means it works with streams of data. To print a message on the screen, you send a stream of characters to `cout`. Let's look at line 7 from [Program 2-1](#):

```
cout << "Programming is great fun!";
```



Notice the `<<` operator is used to send the string "Programming is great fun!" to `cout`. When the `<<` symbol is used this way, it is called the *stream insertion operator*. The item immediately to the right of the operator is sent to `cout` then displayed on the screen.



The stream insertion operator is always written as two less-than signs with no space between them. Because you are using it to send a stream of data to the `cout` object, you can think of the stream insertion operator as an arrow that must point toward `cout`. This is illustrated in [Figure 2-2](#).

**Figure 2-2** Think of `<<` as an arrow pointing to `cout`

```
cout << "Programming is great fun!";
```

Think of the stream insertion operator as an  
arrow that points toward `cout`.

```
cout ← "Programming is great fun!";
```

[Program 2-2](#) is another way to write the same program.

## Program 2-2

```
1 // A simple C++ program
2 #include <iostream>
3 using namespace std;
4
5 int main()
6 {
7     cout << "Programming is " << "great fun!";
8     return 0;
9 }
```

## Program Output

```
Programming is great fun!
```

As you can see, the stream insertion operator can be used to send more than one item to `cout`. The output of this program is identical to that of [Program 2-1](#). [Program 2-3](#) shows yet another way to accomplish the same thing.

## Program 2-3

```
1 // A simple C++ program
2 #include <iostream>
3 using namespace std;
4
5 int main()
6 {
7     cout << "Programming is ";
8     cout << "great fun!";
9     return 0;
10 }
```

### Program Output

```
Programming is great fun!
```

An important concept to understand about [Program 2-3](#) is that, although the output is broken up into two programming statements, this program will still display the message on one line. Unless you specify otherwise, the information you send to `cout` is displayed in a continuous stream. Sometimes this can produce less-than-desirable results. [Program 2-4](#) is an example.

## Program 2-4

```
1 // An unruly printing program
2 #include <iostream>
3 using namespace std;
4
5 int main()
6 {
7     cout << "The following items were top sellers";
8     cout << "during the month of June:";
9     cout << "Computer games";
10    cout << "Coffee";
11    cout << "Aspirin";
12    return 0;
13 }
```

### Program Output

```
The following items were top sellersduring the month of June:Computer
gamesCoffeeAspirin
```

The layout of the actual output looks nothing like the arrangement of the strings in the source code. First, notice there is no space displayed between the words “sellers” and “during,” or between “June:” and “Computer.” `cout` displays messages exactly as they are sent. If spaces are to be displayed, they must appear in the strings.

Second, even though the output is broken into five lines in the source code, it comes out as one long line of output. Because the output is too long to fit on one line on the screen, it wraps around to a second line when displayed. The reason the output comes out as one long line is because `cout` does not start a new line unless told to do so. There are two ways to instruct `cout` to start a new line. The first is to send `cout` a *stream manipulator* called `endl` (which is pronounced “end-line” or “end-L”). [Program 2-5](#) is an example.

## Program 2-5

```
1 // A well-adjusted printing program
2 #include <iostream>
3 using namespace std;
4
5 int main()
6 {
7     cout << "The following items were top sellers" << endl;
8     cout << "during the month of June:" << endl;
9     cout << "Computer games" << endl;
10    cout << "Coffee" << endl;
11    cout << "Aspirin" << endl;
12    return 0;
13 }
```

## Program Output

```
The following items were top sellers
during the month of June:
Computer games
Coffee
Aspirin
```



### Note:

The last character in `endl` is the lowercase letter L, *not* the number one.

Every time `cout` encounters an `endl` stream manipulator, it advances the output position to the beginning of the next line for subsequent printing. The manipulator can be inserted anywhere in the

stream of characters sent to `cout`, outside the double quotes. The following statements show an example.

```
cout << "My pets are" << endl << "dog";  
cout << endl << "cat" << endl << "bird" << endl;
```

Another way to cause `cout` to go to a new line is to insert an *escape sequence* in the string itself. An escape sequence starts with the backslash character (`\`) and is followed by one or more control characters. It allows you to control the way output is displayed by embedding commands within the string itself. [Program 2-6](#) is an example.

## Program 2-6

```
1 // Yet another well-adjusted printing program  
2 #include <iostream>  
3 using namespace std;  
4  
5 int main()  
6 {  
7     cout << "The following items were top sellers\n";  
8     cout << "during the month of June:\n";  
9     cout << "Computer games\nCoffee";  
10    cout << "\nAspirin\n";  
11    return 0;  
12 }
```

## Program Output

```
The following items were top sellers  
during the month of June:  
Computer games  
Coffee  
Aspirin
```

The *newline escape sequence* is `\n`. When `cout` encounters `\n` in a string, it doesn't print it on the screen, but interprets it as a special command to advance the output cursor to the next line. You have probably noticed inserting the escape sequence requires less typing than inserting `endl`. That's why many programmers prefer it.

A common mistake made by beginning C++ students is to use a forward slash (`/`) instead of a backslash (`\`) when trying to write an escape sequence. This will not work. For example, look at the following code:

```
// Error!  
cout << "Four Score/nAnd seven/nYears ago./n";
```

In this code, the programmer accidentally wrote `/n` when he or she meant to write `\n`. The `cout` object will simply display the `/n` characters on the screen. This code will display the following output:

```
Four Score/nAnd seven/nYears ago./n
```

Another common mistake is to forget to put the `\n` inside quotation marks. For example, the following code will not compile:

```
// Error! This code will not compile.  
cout << "Good" << \n;  
cout << "Morning" << \n;
```

This code will result in an error because the `\n` sequences are not inside quotation marks. We can correct the code by placing the `\n` sequences inside the string literals, as shown here:

```
// This will work.  
cout << "Good\n";  
cout << "Morning\n";
```

There are many escape sequences in C++. They give you the ability to exercise greater control over the way information is output by your program. [Table 2-2](#) lists a few of them.

### Table 2-2 Common Escape Sequences



## Warning!

When using escape sequences, do not put a space between the backslash and the control character.

When you type an escape sequence in a string, you type two characters (a backslash followed by another character). However, an escape sequence is stored in memory as a single character. For example, consider the following string literal:

```
"One\nTwo\nThree\n"
```

The diagram in [Figure 2-3](#) breaks this string into its individual characters. Notice how each of the `\n` escape sequences are considered one character.

**Figure 2-3 Individual characters in a string**

O n e \n T w o \n T h r e e \n



## 2.3 The `#include` Directive

### Concept:

The `#include` directive causes the contents of another file to be inserted into the program.

Now is a good time to expand our discussion of the `#include` directive. The following line has appeared near the top of every example program.

```
#include <iostream>
```

The header file `iostream` must be included in any program that uses the `cout` object. This is because `cout` is not part of the “core” of the C++ language. Specifically, it is part of the *input–output stream library*. The header file, `iostream`, contains information describing `iostream` objects. Without it, the compiler will not know how to properly compile a program that uses `cout`.

Preprocessor directives are not C++ statements. They are commands to the preprocessor, which runs prior to the compiler (hence the name “preprocessor”). The preprocessor’s job is to set programs up in a way that makes life easier for the programmer.

For example, any program that uses the `cout` object must contain the extensive setup information found in `iostream`. The programmer could type all this information into the program, but it would be too time consuming. An alternative would be to use an editor to “cut and paste” the information into the program, but that would quickly become tiring as well. The solution is to let the preprocessor insert the contents of `iostream` automatically.



## Warning!

Do not put semicolons at the end of processor directives. Because preprocessor directives are not C++ statements, they do not require semicolons. In many cases, an error will result from a preprocessor directive terminated with a semicolon.

An `#include` directive must always contain the name of a file. The preprocessor inserts the entire contents of the file into the program at the point it encounters the `#include` directive. The compiler

doesn't actually see the `#include` directive. Instead, it sees the code that was inserted by the preprocessor, just as if the programmer had typed it there.

The code contained in header files is C++ code. Typically, it describes complex objects like `cout`. Later, you will learn to create your own header files.

# Checkpoint

2.2 The following C++ program will not compile because the lines have been mixed up.

```
cout << "Success\n";  
cout << " Success\n\n";  
int main()  
cout << "Success";  
}  
using namespace std;  
// It's a mad, mad program  
#include <iostream>  
cout << "Success\n";  
{  
return 0;
```

When the lines are properly arranged, the program should display the following on the screen:

```
Success  
Success Success  
  
Success
```

Rearrange the lines in the correct order. Test the program by entering it on the computer, compiling it, and running it.

2.3 Study the following program and show what it will print on the screen:

```
// The Works of Wolfgang
#include <iostream>
using namespace std;
int main()
{
    cout << "The works of Wolfgang\ninclude the
following";
    cout << "\nThe Turkish March" << endl;
    cout << "and Symphony No. 40 ";
    cout << "in G minor." << endl;
    return 0;
}
```

2.4 Write a program that will display your name on the first line, your street address on the second line, your city, state, and ZIP code on the third line, and your telephone number on the fourth line. Place a comment with today's date at the top of the program. Test your program by compiling and running it.

## 2.4 Variables, Literals, and Assignment Statements

### Concept:

Variables represent storage locations in the computer's memory. Literals are constant values that are assigned to variables.

As you discovered in [Chapter 1](#), variables allow you to store and work with data in the computer's memory. They provide an "interface" to RAM. Part of the job of programming is to determine how many variables a program will need and what types of information they will hold. [Program 2-7](#) is an example of a C++ program with a variable. Take a look at line 7:

## Program 2-7

```
1 // This program has a variable.
2 #include <iostream>
3 using namespace std;
4
5 int main()
6 {
7     int number;
8
9     number = 5;
10    cout << "The value in number is " <<
number << endl;
11    return 0;
12 }
```

## Program Output

```
The value in number is 5
```

```
int number;
```

This is called a *variable definition*. It tells the compiler the variable's name and the type of data it will hold. This line indicates the variable's name is `number`. The word `int` stands for integer, so `number` will only be used to hold integer numbers. Later in this chapter, you will learn all the types of data that C++ allows.



## Variable Definitions



### Note:

You must have a definition for every variable you intend to use in a program. In C++, variable definitions can appear at any point in the program. Later in this chapter, and throughout the book, you will learn the best places to define variables.



Notice variable definitions end with a semicolon. Now look at line 9:

```
number = 5;
```

This is called an *assignment*. The equal sign is an operator that copies the value on its right (5) into the variable named on its left (`number`). After this line executes, `number` will be set to 5.




### Note:

This line does not print anything on the computer's screen. It runs silently behind the scenes, storing a value in RAM.

Look at line 10:

```
cout << "The value in number is " << number << endl;
```

The second item sent to `cout` is the variable name `number`. When you send a variable name to `cout`, it prints the variable's contents. Notice there are no quotation marks around `number`. Look at what happens in [Program 2-8](#) .

## Program 2-8

```
1 // This program has a variable.
2 #include <iostream>
3 using namespace std;
4
5 int main()
6 {
7     int number;
8
9     number = 5;
10    cout << "The value in number is " <<
    "number" << endl;
11    return 0;
12 }
```

## Program Output

```
The value in number is number
```

When double quotation marks are placed around the word `number`, it becomes a string literal and is no longer a variable name. When string literals are sent to `cout`, they are printed exactly as they appear inside the quotation marks. You've probably noticed by now that the `endl` stream manipulator has no quotation marks around it, for the same reason.

# Sometimes a Number Isn't a Number

As shown in [Program 2-8](#), just placing quotation marks around a variable name changes the program's results. In fact, placing double quotation marks around anything that is not intended to be a string literal will create an error of some type. For example, in [Program 2-8](#), the number 5 was assigned to the variable `number`. It would have been incorrect to perform the assignment this way:

```
number = "5";
```

In this line, 5 is no longer an integer, but a string literal. Because `number` was defined as an integer variable, you can only store integers in it. The integer 5 and the string literal "5" are not the same thing.

The fact that numbers can be represented as strings frequently confuses students who are new to programming. Just remember that strings are intended for humans to read. They are to be printed on computer screens or paper. Numbers, however, are intended primarily for mathematical operations. You cannot perform math on strings. Before numbers can be displayed on the screen, they must

first be converted to strings. (Fortunately, `cout` handles the conversion automatically when you send a number to it.)

# Literals

A literal is a piece of data that is written directly into a program's code. One of the most common uses of literals is to assign a value to a variable. For example, in the following statement, assume `number` is an `int` variable. The statement assigns the literal value 100 to the variable `number`.

```
number = 100;
```

Another common use of literals is to display something on the screen. For example, the following statement displays the string literal "Welcome to my program."

```
cout << "Welcome to my program." << endl;
```


**Program 2-9**  shows an example that uses a variable and several literals.

## Program 2-9

```
1 // This program has literals and a variable.
2 #include <iostream>
3 using namespace std;
4
5 int main()
6 {
7     int apples;
8
9     apples = 20;
10    cout << "Today we sold " << apples << "
bushels of apples.\n";
11    return 0;
12 }
```

## Program Output

```
Today we sold 20 bushels of apples.
```

Of course, the variable is `apples`. It is defined as an integer. **Table 2-3**  lists the literals found in the program.

### Table 2-3 Literals and Their Types



***Note:***

Literals are also called constants.





## 2.5 Examine the following program:

```
// This program uses variables and literals.
#include <iostream>
using namespace std;
int main()
{
    int little;
    int big;
    little = 2;
    big = 2000;
    cout << "The little number is " << little << endl;
    cout << "The big number is " << big << endl;
    return 0;
}
```

List all the variables and literals that appear in the program.


2.6 What will the following program display on the screen?

```
#include <iostream>
using namespace std;
int main()
{
    int number;
    number = 712;
    cout << "The value is " << "number" << endl;
    return 0;
}
```

## 2.5 Identifiers

### Concept:

Choose variable names that indicate what the variables are used for.

An *identifier* is a programmer-defined name that represents some element of a program. Variable names are examples of identifiers. You may choose your own variable names in C++, as long as you do not use any of the C++ *key words*. The key words make up the “core” of the language and have specific purposes. [Table 2-4](#)  shows a complete list of the C++ key words. Note they are all lowercase.

### Table 2-4 The C++ Key Words

You should always choose names for your variables that give an indication of what the variables are used for. You may be tempted to define variables with names like this:

```
int x;
```

The rather nondescript name, `x`, gives no clue as to the variable's purpose. Here is a better example.

```
int itemsOrdered;
```

The name `itemsOrdered` gives anyone reading the program an idea of the variable's use. This way of coding helps produce self-documenting programs, which means you get an understanding of what the program is doing just by reading its code. Because real-world programs usually have thousands of lines, it is important that they be as self-documenting as possible.

You probably have noticed the mixture of uppercase and lowercase letters in the name `itemsOrdered`. Although all of C++'s key words must be written in lowercase, you may use uppercase letters in variable names.

The reason the `O` in `itemsOrdered` is capitalized is to improve readability. Normally "items ordered" is two words. Unfortunately, you cannot have spaces in a variable name, so the two words must be combined into one. When "items" and "ordered" are stuck together, you get a variable definition like this:

```
int itemsordered;
```


Capitalization of the first letter of the second word and succeeding words makes `itemsOrdered` easier to read. It should be mentioned that this style of coding is not required. You are free to use all lowercase letters, all uppercase letters, or any combination of both. In fact, some programmers use the underscore character to separate words in a variable name, as in the following.

```
int items_ordered;
```

# Legal Identifiers

Regardless of which style you adopt, be consistent and make your variable names as sensible as possible. Here are some specific rules that must be followed with all identifiers.

- The first character must be one of the letters a through z, A through Z, or an underscore character (`_`).
- After the first character you may use the letters a through z or A through Z, the digits 0 through 9, or underscores.
- Uppercase and lowercase characters are distinct. This means `ItemsOrdered` is not the same as `itemsordered`.

**Table 2-5**  lists variable names and tells whether each is legal or illegal in C++.

## Table 2-5 Some Variable Names

## 2.6 Integer Data Types

### **Concept:**

There are many different types of data. Variables are classified according to their data type, which determines the kind of information that may be stored in them. Integer variables can only hold whole numbers.

Computer programs collect pieces of data from the real world and manipulate them in various ways. There are many different types of data. In the realm of numeric information, for example, there are whole numbers and fractional numbers. There are negative numbers and positive numbers. And there are numbers so large, and others so small, they don't even have a name. Then there is textual information. Names and addresses, for instance, are stored as groups of characters. When you write a program, you must determine what types of information it will be likely to encounter.

If you are writing a program to calculate the number of miles to a distant star, you'll need variables that can hold very large numbers. If you are designing software to record microscopic dimensions, you'll need to store very small and precise numbers. Additionally, if you are


writing a program that must perform thousands of intensive calculations, you'll want variables that can be processed quickly. The data type of a variable determines all of these factors.

Although C++ offers many data types, in the very broadest sense there are only two: numeric and character. Numeric data types are broken into two additional categories: integer and floating point. Integers are whole numbers like 12, 157, -34, and 2. Floating-point numbers have a decimal point, like 23.7, 189.0231, and 0.987. Additionally, the integer and floating-point data types are broken into even more classifications. Before we discuss the character data type, let's carefully examine the variations of numeric data.

Your primary considerations for selecting a numeric data type are

- The largest and smallest numbers that may be stored in the variable
- How much memory the variable uses
- Whether the variable stores signed or unsigned numbers
- The number of decimal places of precision the variable has

The size of a variable is the number of bytes of memory it uses. Typically, the larger a variable is, the greater the range it can hold.

**Table 2-6**  shows the C++ integer data types with their typical sizes and ranges.

### **Table 2-6 Integer Data Types**





## Note:

The data type sizes and ranges shown in [Table 2-6](#) are typical on many systems. Depending on your operating system, the sizes and ranges may be different.

Here are some examples of variable definitions:

```
int days;  
unsigned int speed;  
short int month;  
unsigned short int amount;  
long int deficit;  
unsigned long int insects;
```

Each of the data types in [Table 2-6](#), except `int`, can be abbreviated as follows:

- `short int` can be abbreviated as `short`
- `unsigned short int` can be abbreviated as `unsigned short`
- `unsigned int` can be abbreviated as `unsigned`
- `long int` can be abbreviated as `long`

- `unsigned long int` can be abbreviated as `unsigned long`
- `long long int` can be abbreviated as `long long`
- `unsigned long long int` can be abbreviated as `unsigned long long`

Because they simplify definition statements, programmers commonly use the abbreviated data type names. Here are some examples:

```
unsigned speed;  
short month;  
unsigned short amount;  
long deficit;  
unsigned long insects;  
long long grandTotal;  
unsigned long long lightYearDistance;
```

Unsigned data types can only store nonnegative values. They can be used when you know your program will not encounter negative values. For example, variables that hold ages or weights would rarely hold numbers less than 0.

Notice in [Table 2-6](#) the `int` and `long` data types have the same sizes and ranges, and that the `unsigned int` data type has the same size and range as the `unsigned long` data type. This is not always true because the size of integers is dependent on the type of system you are using. Here are the only guarantees:

- Integers are at least as big as short integers.
- Long integers are at least as big as integers.
- Unsigned short integers are the same size as short integers.
- Unsigned integers are the same size as integers.
- Unsigned long integers are the same size as long integers.
- The `long long int` and the `unsigned long long int` data types are guaranteed to be at least 8 bytes (64 bits) in size.

Later in this chapter, you will learn to use the `sizeof` operator to determine how large all the data types are on your computer.



### Note:

The `long long int` and the `unsigned long long int` data types were introduced in C++ 11.

As mentioned before, variables are defined by stating the data type key word followed by the name of the variable. In [Program 2-10](#), an integer, an unsigned integer, and a long integer have been defined.

## Program 2-10

```
1 // This program has variables of several of
the integer types.
2 #include <iostream>
3 using namespace std;
4
5 int main()
6 {
7     int checking;
8     unsigned int miles;
9     long days;
10
11     checking = -20;
12     miles = 4276;
13     diameter = 100000;
14     cout << "We have made a long journey of "
<< miles;
15     cout << " miles.\n";
16     cout << "Our checking account balance is "
<< checking;
17     cout << "\nThe galaxy is about " <<
diameter;
18     cout << " light years in diameter.\n";
```

```
19     return 0;
20 }
```

## Program Output


```
We have made a long journey of 4276 miles.
Our checking account balance is -20
The galaxy is about 100000 light years in
diameter.
```

In most programs, you will need more than one variable of any given data type. If a program uses two integers, `length` and `width`, they could be defined separately, like this:

```
int length;
int width;
```

It is easier, however, to combine both variable definitions on one line:

```
int length, width;
```

You can define several variables of the same type like this, simply by separating their names with commas. **Program 2-11**  illustrates this.

## Program 2-11

```
1 // This program shows three variables defined
on the same line.
2 #include <iostream>
3 using namespace std;
4
5 int main()
6 {
7     int floors, rooms, suites;
8
9     floors = 15;
10    rooms = 300;
11    suites = 30;
12    cout << "The Grande Hotel has " << floors
<< " floors\n";
13    cout << "with " << rooms << " rooms and "
<< suites;
14    cout << " suites.\n";
15    return 0;
16 }
```

## Program Output

The Grande Hotel has 15 floors  
with 300 rooms and 30 suites.



# Integer and Long Integer Literals

In C++, if a numeric literal is an integer (not written with a decimal point) and it fits within the range of an `int` (see [Table 2-6](#) for the minimum and maximum values), then the numeric literal is treated as an `int`. A numeric literal that is treated as an `int` is called an *integer literal*. For example, look at lines 9, 10, and 11 in [Program 2-11](#):

```
floors = 15;  
rooms = 300;  
suites = 30;
```

Each of these statements assigns an integer literal to a variable.

One of the pleasing characteristics of the C++ language is that it allows you to control almost every aspect of your program. If you need to change the way something is stored in memory, the tools are provided to do that. For example, what if you are in a situation where you have an integer literal, but you need it to be stored in memory as a long integer? (Rest assured, this is a situation that does arise.) C++ allows you to force an integer literal to be stored as a long integer by placing the letter L at the end of the number. Here is an example:

```
long amount;  
amount = 32L;
```

The first statement defines a `long` variable named `amount`. The second statement assigns the literal value 32 to the `amount` variable. In the second statement, the literal is written as `32L`, which makes it a *long integer literal*. This means the literal is treated as a `long`.

**11** If you want an integer literal to be treated as a `long long int`, you can append `LL` at the end of the number. Here is an example:

```
long long amount;  
amount = 32LL;
```

The first statement defines a `long long` variable named `amount`. The second statement assigns the literal value 32 to the `amount` variable. In the second statement, the literal is written as `32LL`, which makes it a *long long integer literal*. This means the literal is treated as a `long long int`.

 **Tip:**

When writing long integer literals or long long integer literals, you can use either an uppercase or a lowercase L. Because the lowercase l looks like the number 1, you should always use the uppercase L.

# If You Plan to Continue in Computer Science: Hexadecimal and Octal Literals

Programmers commonly express values in numbering systems other than decimal (or base 10). Hexadecimal (base 16) and octal (base 8) are popular because they make certain programming tasks more convenient than decimal numbers do.

By default, C++ assumes that all integer literals are expressed in decimal. You express hexadecimal numbers by placing 0x in front of them. (This is zero-x, not oh-x.) Here is how the hexadecimal number F4 would be expressed in C++:

```
0xF4
```

Octal numbers must be preceded by a 0 (zero, not oh). For example, the octal 31 would be written

```
031
```



**Note:**

You will not be writing programs for some time that require this type of manipulation. It is important, however, that you understand this material. Good programmers should develop the skills for reading other people's source code. You may find yourself reading programs that use items like long integer, hexadecimal, or octal literals.



2.7 Which of the following are illegal variable names, and why?

```
x  
99bottles  
july97  
theSalesFigureForFiscalYear98  
r&d  
grade_report
```

2.8 Is the variable name `Sales` the same as `sales`? Why or why not?

2.9 Refer to the data types listed in [Table 2-6](#) for these questions.

- A. If a variable needs to hold numbers in the range 32 to 6,000, what data type would be best?
- B. If a variable needs to hold numbers in the range 240,000 to 140,000, what data type would be best?
- C. Which of the following literals uses more memory? `20` or `20L`

2.10 On any computer, which data type uses more memory, an integer or an unsigned integer?

## 2.7 The `char` Data Type

The `char` data type is used to store individual characters. A variable of the `char` data type can hold only one character at a time. Here is an example of how you might declare a `char` variable:

```
char letter;
```


This statement declares a `char` variable named `letter`, which can store one character. In C++, *character literals* are enclosed in single quotation marks. Here is an example showing how we would assign a character to the `letter` variable:

```
letter = 'g';
```

This statement assigns the character `'g'` to the `letter` variable. Because `char` variables can hold only one character, they are not compatible with strings. For example, you cannot assign a string to a `char` variable, even if the string contains only one character. The following statement, for example, will not compile because it attempts to assign a string literal to a `char` variable.

```
letter = "g"; // ERROR! Cannot assign a string to a char
```

It is important that you do not confuse character literals, which are enclosed in single quotation marks, with string literals, which are enclosed in double quotation marks.

**Program 2-12**  shows an example program that works with characters.



## Program 2-12

```
1 // This program works with characters.
2 #include <iostream>
3 using namespace std;
4
5 int main()
6 {
7     char letter;
8
9     letter = 'A';
10    cout << letter << endl;
11    letter = 'B';
12    cout << letter << endl;
13    return 0;
14 }
```

## Program Output



```
A
B
```

Although the `char` data type is used for storing characters, it is actually an integer data type that typically uses 1 byte of memory. (The size is system dependent. On some systems, the `char` data type is larger than 1 byte.)

The reason an integer data type is used to store characters is because characters are internally represented by numbers. Each printable character, as well as many nonprintable characters, is assigned a unique number. The most commonly used method for encoding characters is ASCII, which stands for the American Standard Code for Information Interchange. (There are other codes, such as EBCDIC, which is used by many IBM mainframes.)

When a character is stored in memory, it is actually the numeric code that is stored. When the computer is instructed to print the value on the screen, it displays the character that corresponds with the numeric code.

You may want to refer to [Appendix A](#), which shows the ASCII character set. Notice the number 65 is the code for A, 66 is the code for B, and so on. [Program 2-13](#) demonstrates that when you work with characters, you are actually working with numbers.

## Program 2-13

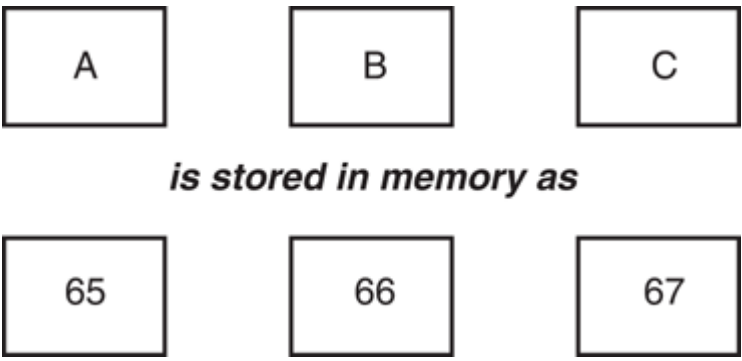
```
1 // This program demonstrates the close
relationship between
2 // characters and integers.
3 #include <iostream>
4 using namespace std;
5
6 int main()
7 {
8     char letter;
9
10    letter = 65;
11    cout << letter << endl;
12    letter = 66;
13    cout << letter << endl;
14    return 0;
15 }
```

### Program Output



**Figure 2-4** illustrates that when characters, such as A, B, and C, are stored in memory, it is really the numbers 65, 66, and 67 that are stored.

**Figure 2-4 Characters and their ASCII codes**



# The Difference between String Literals and Character Literals

It is important that you do not confuse character literals with string literals. Strings, which are a series of characters stored in consecutive memory locations, can be virtually any length. This means that there must be some way for the program to know how long a string is. In C++, an extra byte is appended to the end of string literals when they are stored in memory. In this last byte, the number 0 is stored. It is called the *null terminator* or *null character*, and it marks the end of the string.

Don't confuse the null terminator with the character `'0'`. If you look at [Appendix A](#), you will see that ASCII code 48 corresponds to the character `'0'`, whereas the null terminator is the same as the ASCII code 0. If you want to print the character 0 on the screen, you use ASCII code 48. If you want to mark the end of a string, however, you use ASCII code 0.

Let's look at an example of how a string literal is stored in memory. [Figure 2-5](#) depicts the way the string literal `"Sebastian"` would be stored.

**Figure 2-5** The string literal `"Sebastian"`

S	e	b	a	s	t	i	a	n	\0
---	---	---	---	---	---	---	---	---	----


First, notice the quotation marks are not stored with the string. They are simply a way of marking the beginning and end of the string in your source code. Second, notice the very last byte of the string. It contains the null terminator, which is represented by the `\0` character. The addition of this last byte means that although the string `"Sebastian"` is 9 characters long, it occupies 10 bytes of memory.

The null terminator is another example of something that sits quietly in the background. It doesn't print on the screen when you display a string, but nevertheless, it is there silently doing its job.



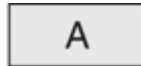
**Note:**

C++ automatically places the null terminator at the end of string literals.

Now let's compare the way a string and a `char` are stored. Suppose you have the literals `'A'` and `"A"` in a program. [Figure 2-6](#)  depicts their internal storage.

## Figure 2-6 'A' as a character and "A" as a string

'A' is stored as



"A" is stored as



As you can see, 'A' is a 1-byte element and "A" is a 2-byte element. Since characters are really stored as ASCII codes, [Figure 2-7](#) shows what is actually being stored in memory.

## Figure 2-7 ASCII codes

'A' is stored as





"A" is stored as



Because `char` variables are only large enough to hold one character, you cannot assign string literals to them. For example, the following code defines a `char` variable named `letter`. The character literal `'A'` can be assigned to the variable, but the string literal `"A"` cannot.

```
char letter;  
letter = 'A'; // This will work.  
letter = "A"; // This will not work!
```

One final topic about characters should be discussed. You have learned that some strings look like a single character but really aren't. It is also possible to have a character that looks like a string. A good example is the newline character, `\n`. Although it is represented by two characters, a slash and an `n`, it is internally represented as one character. In fact, all escape sequences, internally, are just 1 byte.

**Program 2-14**  shows the use of `\n` as a character literal, enclosed in single quotation marks. If you refer to the ASCII chart in **Appendix A** , you will see that ASCII code 10 is the linefeed character. This is the code C++ uses for the newline character.



## Program 2-14

```
1 // This program uses character literals.
2 #include <iostream>
3 using namespace std;
4
5 int main()
6 {
7     char letter;
8
9     letter = 'A';
10    cout << letter << '\n';
11    letter = 'B';
12    cout << letter << '\n';
13    return 0;
14 }
```

## Program Output



A

B

Let's review some important points regarding characters and strings:

- Printable characters are internally represented by numeric codes. Most computers use ASCII codes for this purpose.
- Characters normally occupy a single byte of memory.
- Strings are consecutive sequences of characters that occupy consecutive bytes of memory.
- String literals are always stored in memory with a null terminator at the end. This marks the end of the string.
- Character literals are enclosed in single quotation marks.
- String literals are enclosed in double quotation marks.
- Escape sequences such as `'\n'` are stored internally as a single character.

## 2.8 The C++ `string` Class

### **Concept:**

Standard C++ provides a special data type for storing and working with strings.

Because a `char` variable can store only one character in its memory location, another data type is needed for a variable able to hold an entire string. Although C++ does not have a built-in data type able to do this, standard C++ provides something called the `string` class that allows the programmer to create a `string` type variable.

# Using the `string` Class

The first step in using the `string` class is to `#include` the `<string>` header file. This is accomplished with the following preprocessor directive:

```
#include <string>
```

The next step is to define a `string` type variable, called a `string` object. Defining a `string` object is similar to defining a variable of a primitive type. For example, the following statement defines a `string` object named `movieTitle`.

```
string movieTitle;
```

You can assign a string literal to `movieTitle` with the assignment operator:

```
movieTitle = "Wheels of Fury";
```

You can use `cout` to display the value of the `movieTitle` object, as shown in the next statement:

```
cout << "My favorite movie is " << movieTitle << endl;
```

**Program 2-15**  is a complete program that demonstrates the preceding statements.

## Program 2-15


```
1 // This program demonstrates the string
class.
2 #include <iostream>
3 #include <string> // Required for the string
class.
4 using namespace std;
5
6 int main()
7 {
8     string movieTitle;
9
10    movieTitle = "Wheels of Fury";
11    cout << "My favorite movie is " <<
movieTitle << endl;
12    return 0;
13 }
```

### Program Output

```
My favorite movie is Wheels of Fury
```

As you can see, working with `string` objects is similar to working with variables of other types. Throughout this text, we will continue to discuss `string` class features and capabilities.

## Checkpoint

2.11 What are the ASCII codes for the following characters?  
(Refer to [Appendix A](#). )

`C`

`F`

`W`

2.12 Which of the following is a character literal?

`'B'`

`"B"`

2.13 Assuming the `char` data type uses 1 byte of memory, how many bytes do the following literals use?

`'Q'`

`"Q"`

`"Sales"`

`'\n'`

2.14 Write a program that has the following character variables: `first`, `middle`, and `last`. Store your initials in these variables then display them on the screen.

2.15 What is wrong with the following program statement?



```
char letter = "Z";
```

2.16 What header file must you include in order to use `string` objects?

2.17 Write a program that stores your name, address, and phone number in three separate `string` objects. Display the contents of the `string` objects on the screen.

## 2.9 Floating-Point Data Types


### **Concept:**

Floating-point data types are used to define variables that can hold real numbers.

Whole numbers are not adequate for many jobs. If you are writing a program that works with dollar amounts or precise measurements, you need a data type that allows fractional values. In programming terms, these are called *floating-point* numbers.

Internally, floating-point numbers are stored in a manner similar to *scientific notation*. Take the number 47,281.97. In scientific notation, this number is  $4.728197 \times 10^4$ . ( $10^4$  is equal to 10,000, and  $4.728197 \times 10,000$  is 47,281.97.) The first part of the number, 4.728197, is called the *mantissa*. The mantissa is multiplied by a power of 10.

Computers typically use *E notation* to represent floating-point values. In E notation, the number 47,281.97 would be 4.728197E4. The part of the number before the E is the mantissa, and the part after the E is the power of 10. When a floating-point number is stored in memory, it is stored as the mantissa and the power of 10.

**Table 2-7**  shows other numbers represented in scientific and E notation.

## Table 2-7 Floating-Point Representations

In C++, there are three data types that can represent floating-point numbers. They are

```
float
double
long double
```

The `float` data type is considered *single precision*. The `double` data type is usually twice as big as `float`, so it is considered *double precision*. As you've probably guessed, the `long double` is intended to be larger than the `double`. Of course, the exact sizes of these data types are dependent on the computer you are using. The only guarantees are

- A `double` is at least as big as a `float`.
- A `long double` is at least as big as a `double`.

**Table 2-8**  shows the typical sizes and ranges of floating-point data types.

## Table 2-8 Floating-Point Data Types on PCs

You will notice there are no unsigned floating-point data types. On all machines, variables of the `float`, `double`, and `long double` data types can store positive or negative numbers.

# Floating-Point Literals

Floating-point literals may be expressed in a variety of ways. As shown in [Program 2-16](#), E notation is one method. When you are writing numbers that are extremely large or extremely small, this will probably be the easiest way. E notation numbers may be expressed with an uppercase E or a lowercase e. Notice in the source code, the literals were written as 1.495979E11 and 1.989E30, but the program printed them as 1.49598e+011 and 1.989e+30. The two sets of numbers are equivalent. (The plus sign in front of the exponent is also optional.) In [Chapter 3](#), you will learn to control the way `cout` displays E notation numbers.

## Program 2-16

```
1 // This program uses floating-point data
types.
2 #include <iostream>
3 using namespace std;
4
5 int main()
6 {
7     float distance;
8     double mass;
9
10    distance = 1.495979E11;
11    mass = 1.989E30;
12    cout << "The Sun is " << distance << "
meters away.\n";
13    cout << "The Sun\'s mass is " << mass << "
kilograms.\n";
14    return 0;
15 }
```

## Program Output

```
The Sun is 1.49598e+011 meters away.  
The Sun's mass is 1.989e+030 kilograms.
```

You can also express floating-point literals in decimal notation. The literal `1.495979E11` could have been written as:

```
149597900000.00
```

Obviously the E notation is more convenient for lengthy numbers, but for numbers like `47.39`, decimal notation is preferable to `4.739E1`.

All of the following floating-point literals are equivalent:

```
1.4959E11  
1.4959e11  
1.4959E+11  
1.4959e+11  
149590000000.00
```

Floating-point literals are normally stored in memory as `double`s. But remember, C++ provides tools for handling just about any

situation. Just in case you need to force a literal to be stored as a `float`, you can append the letter F or f to the end of it. For example, the following literals would be stored as `float`s:

```
1.2F
```

```
45.907f
```





## Note:

Because floating-point literals are normally stored in memory as `double`s, most compilers issue a warning message when you assign a floating-point literal to a `float` variable. For example, assuming `num` is a `float`, the following statement might cause the compiler to generate a warning message:

```
num = 14.725;
```

You can suppress the warning message by appending the `f` suffix to the floating-point literal, as shown below:

```
num = 14.725f;
```

If you want to force a value to be stored as a `long double`, append an `L` or `l` to it, as in the following examples:

```
1034.56L
```

```
89.21
```

The compiler won't confuse these with long integers because they have decimal points. (Remember, the lowercase `l` looks so much like the number 1 that you should always use the uppercase `L` when suffixing literals.)

# Assigning Floating-Point Values to Integer Variables

When a floating-point value is assigned to an integer variable, the fractional part of the value (the part after the decimal point) is discarded. For example, look at the following code:

```
int number;  
number = 7.5;    // Assigns 7 to number
```

This code attempts to assign the floating-point value 7.5 to the integer variable `number`. As a result, the value 7 will be assigned to `number`, with the fractional part discarded. When part of a value is discarded, it is said to be *truncated*.

Assigning a floating-point variable to an integer variable has the same effect. For example, look at the following code:

```
int i;  
float f;  
f = 7.5;  
i = f;    // Assigns 7 to i.
```

When the `float` variable `f` is assigned to the `int` variable `i`, the value being assigned (7.5) is truncated. After this code executes, `i` will hold the value 7 and `f` will hold the value 7.5.



### **Note:**

When a floating-point value is truncated, it is not rounded. Assigning the value 7.9 to an `int` variable will result in the value 7 being stored in the variable.



### **Warning!**


Floating-point variables can hold a much larger range of values than integer variables can. If a floating-point value is being stored in an integer variable, and the whole part of the value (the part before the decimal point) is too large for the integer variable, an invalid value will be stored in the integer variable.

## 2.10 The `bool` Data Type

### Concept:

Boolean variables are set to either `true` or `false`.

Expressions that have a `true` or `false` value are called *Boolean* expressions, named in honor of English mathematician George Boole (1815–1864).

The `bool` data type allows you to create small integer variables that are suitable for holding `true` or `false` values. [Program 2-17](#)  demonstrates the definition and assignment of a `bool` variable.

## Program 2-17

```
1 // This program demonstrates boolean
variables.
2 #include <iostream>
3 using namespace std;
4
5 int main()
6 {
7     bool boolValue;
8
9     boolValue = true;
10    cout << boolValue << endl;
11    boolValue = false;
12    cout << boolValue << endl;
13    return 0;
14 }
```

### Program Output


```
1  
0
```


As you can see from the program output, the value `true` is represented in memory by the number 1, and `false` is represented by 0. You will not be using `bool` variables until [Chapter 4](#), however, so just remember they are useful for evaluating conditions that are either true or false.

## 2.11 Determining the Size of a Data Type

### Concept:

The `sizeof` operator may be used to determine the size of a data type on any system.

**Chapter 1**  discussed the portability of the C++ language. As you have seen in this chapter, one of the problems of portability is the lack of common sizes of data types on all machines. If you are not sure what the sizes of data types are on your computer, C++ provides a way to find out.

A special operator called `sizeof` will report the number of bytes of memory used by any data type or variable. **Program 2-18**  illustrates its use. The first line that uses the operator is line 10:



## Program 2-18

```
1 // This program determines the size of
integers, long
2 // integers, and long doubles.
3 #include <iostream>
4 using namespace std;
5
6 int main()
7 {
8     long double apple;
9
10    cout << "The size of an integer is " <<
sizeof(int);
11    cout << " bytes.\n";
12    cout << "The size of a long integer is "
<< sizeof(long);
13    cout << " bytes.\n";
14    cout << "An apple can be eaten in " <<
sizeof(apple);
15    cout << " bytes!\n";
16    return 0;
17 }
```

## Program Output

```
The size of an integer is 4 bytes.  
The size of a long integer is 4 bytes.  
An apple can be eaten in 8 bytes!
```

```
cout << "The size of an integer is " << sizeof(int);
```

The name of the data type or variable is placed inside the parentheses that follow the operator. The operator “returns” the number of bytes used by that item. This operator can be invoked anywhere you can use an unsigned integer, including in mathematical operations.

## Checkpoint

2.18 Yes or No: Is there an unsigned floating-point data type? If so, what is it?

2.19 How would the following number in scientific notation be represented in E notation?

$$6.31 \times 10^{17}$$

2.20 Write a program that defines an integer variable named `age` and a `float` variable named `weight`. Store your age and weight, as literals, in the variables. The program should display these values on the screen in a manner similar to the following:

```
My age is 26 and my weight is 180 pounds.
```

(Feel free to lie to the computer about your age and your weight—it'll never know!)

## 2.12 More about Variable Assignments and Initialization

### Concept:

An assignment operation assigns, or copies, a value into a variable. When a value is assigned to a variable as part of the variable's definition, it is called an initialization.

As you have already seen in several examples, a value is stored in a variable with an *assignment statement*. For example, the following statement copies the value 12 into the variable `unitsSold`:

```
unitsSold = 12;
```

The = symbol is called the *assignment operator*. Operators perform operations on data. The data that operators work with are called *operands*. The assignment operator has two operands. In the previous statement, the operands are `unitsSold` and `12`.

In an assignment statement, C++ requires the name of the variable receiving the assignment to appear on the left side of the operator. The following statement is incorrect:

```
12 = unitsSold;    // Incorrect!
```

In C++ terminology, the operand on the left side of the = symbol must be an *lvalue*. It is called an lvalue because it is a value that may appear on the left side of an assignment operator. An lvalue is something that identifies a place in memory whose contents may be changed. Most of the time this will be a variable name. The operand on the right side of the = symbol must be an *rvalue*. An rvalue is any expression that has a value. The assignment statement takes the value of the rvalue and puts it in the memory location of the object identified by the lvalue.

You may also assign values to variables as part of the definition. This is called *initialization*. [Program 2-19](#)  shows how it is done.

## Program 2-19

```
1 // This program shows variable initialization.
2 #include <iostream>
3 using namespace std;
4
5 int main()
6 {
7     int month = 2, days = 28;
8
9     cout << "Month " << month << " has " <<
days << " days.\n";
10     return 0;
11 }
```

### Program Output

```
Month 2 has 28 days.
```

As you can see, this simplifies the program and reduces the number of statements that must be typed by the programmer. Here are

examples of other definition statements that perform initialization:

```
double interestRate = 12.9;  
char stockCode = 'D';  
long customerNum = 459L;
```

Of course, there are always variations on a theme. C++ allows you to define several variables and only initialize some of them. Here is an example of such a definition:

```
int flightNum = 89, travelTime, departure = 10, distance;
```

The variable `flightNum` is initialized to 89 and `departure` is initialized to 10. The variables `travelTime` and `distance` remain uninitialized.

# 11 Declaring Variables with the

## `auto` Key Word

C++ 11 introduces an alternative way to define variables, using the `auto` key word and an initialization value. Here is an example:

```
auto amount = 100;
```

Notice this statement uses the word `auto` instead of a data type. The `auto` key word tells the compiler to determine the variable's data type from the initialization value. In this example, the initialization value, 100, is an `int`, so `amount` will be an `int` variable. Here are other examples:

```
auto interestRate = 12.0;  
auto stockCode = 'D';  
auto customerNum = 459L;
```

In this code, the `interestRate` variable will be a `double` because the initialization value, 12.0, is a `double`. The `stockCode` variable will be a `char` because the initialization value, `'D'`, is a `char`. The



`customerNum` variable will be a `long` because the initialization value, `459L`, is a `long`.

These examples show how to use the `auto` key word, but they don't really show its usefulness. The `auto` key word is intended to simplify the syntax of declarations that are more complex than the ones shown here. Later in the book, you will see examples of how the `auto` key word can improve the readability of complex definition statements.

# Alternative Forms of Variable Initialization

The most common way to initialize a variable is to use the assignment operator in the variable definition statement, as shown here:

```
int value = 5;
```

However, there are two alternative techniques for initializing variables. The first is to enclose the initialization value in a set of parentheses, just after the variable name. Here is how you would define the `value` variable and initialize it to 5 using this technique:

```
int value(5);
```

**11** The second alternative, introduced in C++ 11, is to enclose the initialization value in a set of curly braces, just after the variable name. Here is how you would define the `value` variable and initialize it to 5 using the brace notation:

```
int value {5};           // This only works with C++ 11 or higher.
```

Most programmers continue to use the assignment operator to initialize regular variables, as we do throughout this book. However, the brace notation offers an advantage. It checks to make sure the value you are initializing the variable with matches the data type of the variable. For example, assume that `doubleVal` is a `double` variable with 6.2 stored in it. Using the assignment operator, it is possible to write either of the following statements:

```
int value1 = 4.9;           // This will store 4 in value1
int value2 = doubleVal;     // This will store 6 in value2
```


In both cases, the fractional part of the value will be truncated before it is assigned to the variable being defined. This could cause problems, yet C++ compilers allow it. They do issue a warning, but they still build an executable file you can run. If the brace notation is used, however, the compiler indicates that these statements produce an error, and no executable is created. You will have to fix the errors and rebuild the project before you can run the program.

## 2.13 Scope

### **Concept:**

A variable's scope is the part of the program that has access to the variable.

Every variable has a *scope*. The scope of a variable is the part of the program where the variable may be used. The rules that define a variable's scope are complex, and you will only be introduced to the concept here. In other sections of the book, we will revisit this topic and expand on it.

The first rule of scope you should learn is that a variable cannot be used in any part of the program before the definition. [Program 2-20](#)  illustrates this.

## Program 2-20

```
1 // This program can't find its variable.
2 #include <iostream>
3 using namespace std;
4
5 int main()
6 {
7     cout << value; // ERROR! value not defined
8     yet!
9     int value = 100;
10    return 0;
11 }
```

The program will not work because line 7 attempts to send the contents of the variable `value` to `cout` before the variable is defined. The compiler reads your program from top to bottom. If it encounters a statement that uses a variable before the variable is defined, an error will result. To correct the program, the variable definition must be put before any statement that uses it.

## 2.14 Arithmetic Operators

### Concept:

There are many operators for manipulating numeric values and performing arithmetic operations.

C++ offers a multitude of operators for manipulating data. Generally, there are three types of operators: *unary*, *binary*, and *ternary*. These terms reflect the number of operands an operator requires.

Unary operators only require a single operand. For example, consider the following expression:

```
-5
```



## Assignment Statements and Simple Math Expressions

Of course, we understand this represents the value negative five. The literal 5 is preceded by the minus sign. The minus sign, when used this way, is called the *negation operator*. Since it only requires one operand, it is a unary operator.

Binary operators work with two operands. The assignment operator is in this category. Ternary operators, as you may have guessed, require three operands. C++ has only one ternary operator, which will be discussed in [Chapter 4](#).

Arithmetic operations are very common in programming. [Table 2-9](#) shows the common arithmetic operators in C++.

### Table 2-9 Fundamental Arithmetic Operators

Each of these operators works as you probably expect. The addition operator returns the sum of its two operands. In the following assignment statement, the variable `amount` will be assigned the value 12:

```
amount = 4 + 8;
```

The subtraction operator returns the value of its right operand subtracted from its left operand. This statement will assign the value 90 to `temperature`:

```
temperature = 120 - 30;
```

The multiplication operator returns the product of its two operands. In the following statement, `markUp` is assigned the value 3:

```
markUp = 12 * 0.25;
```

The division operator returns the quotient of its left operand divided by its right operand. In the next statement, `points` is assigned the value 5:

```
points = 100 / 20;
```

It is important to note that when both of the division operator's operands are integers, the result of the division will also be an integer. If the result has a fractional part, it will be thrown away. We



will discuss this behavior, which is known as *integer division*, in greater detail later in this section.

The modulus operator, which only works with integer operands, returns the remainder of an integer division. The following statement assigns 2 to `leftOver`:

```
leftOver = 17 % 3;
```

In [Chapter 3](#), you will learn how to use these operators in more complex mathematical formulas. For now, we will concentrate on their basic usage. For example, suppose we need to write a program that calculates and displays an employee's total wages for the week. The regular hours for the work week are 40, and any hours worked over 40 are considered overtime. The employee earns \$18.25 per hour for regular hours, and \$27.78 per hour for overtime hours. The employee has worked 50 hours this week. The following pseudocode algorithm shows the program's logic:

*Regular wages = base pay rate × regular hours*

*Overtime wages = overtime pay rate × overtime hours*

*Total wages = regular wages + overtime wages*

*Display the total wages*

[Program 2-21](#) shows the C++ code for the program.

## Program 2-21

```
1 // This program calculates hourly wages,  
including overtime.  
2 #include <iostream>  
3 using namespace std;  
4  
5 int main()  
6 {  
7     double regularWages, // To hold  
regular wages  
8     basePayRate = 18.25, // Base  
pay rate  
9     regularHours = 40.0, // Hours  
worked less overtime  
10    overtimeWages, // To hold  
overtime wages  
11    overtimePayRate = 27.78, //  
Overtime pay rate  
12    overtimeHours = 10, //  
Overtime hours worked  
13    totalWages; // To hold  
total wages  
14  
15 // Calculate the regular wages.
```

```
16     regularWages = basePayRate * regularHours;
17
18     // Calculate the overtime wages.
19     overtimeWages = overtimePayRate *
overtimeHours;
20
21     // Calculate the total wages.
22     totalWages = regularWages + overtimeWages;
23
24     // Display the total wages.
25     cout << "Wages for this week are $" <<
totalWages << endl;
26     return 0;
27 }
```

## Program Output

```
Wages for this week are $1007.8
```

Let's take a closer look at the program. As mentioned in the comments, there are variables for regular wages, base pay rate, regular hours worked, overtime wages, overtime pay rate, overtime hours worked, and total wages.

Here is line 16, which multiplies `basePayRate` by `regularHours` and stores the result in `regularWages`:

```
regularWages = basePayRate * regularHours;
```

Here is line 19, which multiplies `overtimePayRate` by `overtimeHours` and stores the result in `overtimeWages`:

```
overtimeWages = overtimePayRate * overtimeHours;
```

Line 22 adds the regular wages and the overtime wages and stores the result in `totalWages`:

```
totalWages = regularWages + overtimeWages;
```

Line 25 displays the message on the screen reporting the week's wages.

# Integer Division

When both operands of a division statement are integers, the statement will result in *integer division*. This means the result of the division will be an integer as well. If there is a remainder, it will be discarded. For example, look at the following code:

```
double number;  
number = 5 / 2;
```

This code divides 5 by 2 and assigns the result to the `number` variable. What will be stored in `number`? You would probably assume that 2.5 would be stored in `number` because that is the result your calculator shows when you divide 5 by 2. However, that is not what happens when the previous C++ code is executed. Because the numbers 5 and 2 are both integers, the fractional part of the result will be thrown away, or truncated. As a result, the value 2 will be assigned to the `number` variable.

In the previous code, it doesn't matter that the `number` variable is declared as a `double` because the fractional part of the result is discarded before the assignment takes place. In order for a division operation to return a floating-point value, one of the operands must be of a floating-point data type. For example, the previous code could be written as follows:

```
double number;  
number = 5.0 / 2;
```

In this code, 5.0 is treated as a floating-point number, so the division operation will return a floating-point number. The result of the division is 2.5.




In the

## Spotlight:

### Calculating Percentages and Discounts

Determining percentages is a common calculation in computer programming. Although the % symbol is used in general mathematics to indicate a percentage, most programming languages (including C++) do not use the % symbol for this purpose. In a program, you have to convert a percentage to a floating-point number, just as you would if you were using a calculator. For example, 50 percent would be written as 0.5, and 2 percent would be written as 0.02.

Let's look at an example. Suppose you earn \$6,000 per month and you are allowed to contribute a portion of your gross monthly pay to a retirement plan. You want to determine the amount of your pay that will go into the plan if you contribute 5 percent, 7 percent, or 10 percent of your gross wages. To make this determination, you write the program shown in [Program 2-22](#) .

## Program 2-22

```
1 // This program calculates the amount
of pay that
2 // will be contributed to a retirement
plan if 5%,
3 // 7%, or 10% of monthly pay is
withheld.
4 #include <iostream>
5 using namespace std;
6
7 int main()
8 {
9     // Variables to hold the monthly
pay and the
10     // amount of contribution.
11     double monthlyPay = 6000.0,
contribution;
12
13     // Calculate and display a 5%
contribution.
14     contribution = monthlyPay * 0.05;
15     cout << "5 percent is $" <<
contribution
```



```
16         << " per month.\n";
17
18         // Calculate and display a 7%
contribution.
19         contribution = monthlyPay * 0.07;
20         cout << "7 percent is $" <<
contribution
21         << " per month.\n";
22
23         // Calculate and display a 10%
contribution.
24         contribution = monthlyPay * 0.1;
25         cout << "10 percent is $" <<
contribution
26         << " per month.\n";
27
28         return 0;
29     }
```

## Program Output

```
5 percent is $300 per month.  
7 percent is $420 per month.  
10 percent is $600 per month.
```

Line 11 defines two variables: `monthlyPay` and `contribution`. The `monthlyPay` variable, which is initialized with the value 6000.0, holds the amount of your monthly pay. The `contribution` variable will hold the amount of a contribution to the retirement plan.

The statements in lines 14 through 16 calculate and display 5 percent of the monthly pay. The calculation is done in line 14, where the `monthlyPay` variable is multiplied by 0.05. The result is assigned to the `contribution` variable, which is then displayed in line 15.

Similar steps are taken in lines 18 through 21, which calculate and display 7 percent of the monthly pay, and lines 24 through 26, which calculate and display 10 percent of the monthly pay.

## *Calculating a Percentage Discount*

Another common calculation is determining a percentage discount. For example, suppose a retail business sells an item that is regularly priced at \$59.95, and is planning to have a sale where the item's price will be reduced by 20 percent. You have been asked to write a program to calculate the sale price of the item.

To determine the sale price, you perform two calculations:

- First, you get the amount of the discount, which is 20 percent of the item's regular price.
- Second, you subtract the discount amount from the item's regular price. This gives you the sale price.

**Program 2-23**  shows how this is done in C++.

## Program 2-23

```
1 // This program calculates the sale
price of an item
2 // that is regularly priced at $59.95,
with a 20 percent
3 // discount subtracted.
4 #include <iostream>
5 using namespace std;
6
7 int main()
8 {
9     // Variables to hold the regular
price, the
10    // amount of a discount, and the
sale price.
11    double regularPrice = 59.95,
discount, salePrice;
12
13    // Calculate the amount of a 20%
discount.
14    discount = regularPrice * 0.2;
15
16    // Calculate the sale price by
subtracting the
```

```
17     // discount from the regular price.
18     salePrice = regularPrice -
discount;
19
20     // Display the results.
21     cout << "Regular price: $" <<
regularPrice << endl;
22     cout << "Discount amount: $" <<
discount << endl;
23     cout << "Sale price: $" <<
salePrice << endl;
24     return 0;
25 }
```

## Program Output

```
Regular price: $59.95
Discount amount: $11.99
Sale price: $47.96
```

Line 11 defines three variables. The `regularPrice` variable holds the item's regular price, and is initialized with the value 59.95. The `discount` variable will hold the amount of the

discount once it is calculated. The `salePrice` variable will hold the item's sale price.

Line 14 calculates the amount of the 20 percent discount by multiplying `regularPrice` by 0.2. The result is stored in the `discount` variable. Line 18 calculates the sale price by subtracting `discount` from `regularPrice`. The result is stored in the `salePrice` variable. The `cout` statements in lines 21 through 23 display the item's regular price, the amount of the discount, and the sale price.



In the

## Spotlight:

### Using the Modulus Operator and Integer Division

The modulus operator (`%`) is surprisingly useful. For example, suppose you need to extract the rightmost digit of a number. If you divide the number by 10, the remainder will be the rightmost digit. For instance,  $123 \div 10 = 12$  with a remainder of 3. In a computer program, you would use the modulus operator to perform this operation. Recall that the modulus operator divides an integer by another integer, and gives the remainder. This is demonstrated in [Program 2-24](#). The program extracts the rightmost digit of the number 12345.

## Program 2-24


```
1 // This program extracts the rightmost
digit of a number.
2 #include <iostream>
3 using namespace std;
4
5 int main()
6 {
7     int number = 12345;
8     int rightMost = number % 10;
9
10    cout << "The rightmost digit in "
11         << number << " is "
12         << rightMost << endl;
13
14    return 0;
15 }
```

### Program Output



```
The rightmost digit in 12345 is 5
```

Interestingly, the expression `number % 100` will give you the rightmost two digits in `number`, the expression `number % 1000` will give you the rightmost three digits in `number`, and so on.

The modulus operator (`%`) is useful in many other situations. For example, [Program 2-25](#)  converts 125 seconds to an equivalent number of minutes, and seconds.

## Program 2-25

```
1 // This program converts seconds to
minutes and seconds.
2 #include <iostream>
3 using namespace std;
4
5 int main()
6 {
7     // The total seconds is 125.
8     int totalSeconds = 125;
9
10    // Variables for the minutes and
seconds
11    int minutes, seconds;
12
13    // Get the number of minutes.
14    minutes = totalSeconds / 60;
15
16    // Get the remaining seconds.
17    seconds = totalSeconds % 60;
18
19    // Display the results.
20    cout << totalSeconds << " seconds
```

```
is equivalent to:\n";  
21     cout << "Minutes: " << minutes <<  
endl;  
22     cout << "Seconds: " << seconds <<  
endl;  
23     return 0;  
24 }
```

## Program Output

```
125 seconds is equivalent to:  
Minutes: 2  
Seconds: 5
```

Let's take a closer look at the code:

- Line 8 defines an `int` variable named `totalSeconds`, initialized with the value 125.
- Line 11 declares the `int` variables `minutes` and `seconds`.
- Line 14 calculates the number of minutes in the specified number of seconds. There are 60 seconds in a minute, so this statement divides `totalSeconds` by 60. Notice we are performing integer division in this statement. Both

`totalSeconds` and the numeric literal 60 are integers, so the division operator will return an integer result. This is intentional because we want the number of minutes with no fractional part.

- Line 17 calculates the number of remaining seconds. There are 60 seconds in a minute, so this statement uses the `%` operator to divide the `totalSeconds` by 60, and get the remainder of the division. The result is the number of remaining seconds.
- Lines 20 through 22 display the number of minutes and seconds.



## Checkpoint

2.21 Is the following assignment statement valid or invalid? If it is invalid, why?

```
72 = amount;
```

2.22 How would you consolidate the following definitions into one statement?

```
int x = 7;  
int y = 16;  
int z = 28;
```

2.23 What is wrong with the following program? How would you correct it?

```
#include <iostream>  
using namespace std;  
int main()  
{  
    number = 62.7;  
    double number;  
    cout << number << endl;  
    return 0;  
}
```

2.24 Is the following an example of integer division or floating-point division? What value will be stored in `portion`?

```
portion = 70 / 3;
```

## 2.15 Comments

### **Concept:**

Comments are notes of explanation that document lines or sections of a program. Comments are part of the program, but the compiler ignores them. They are intended for people who may be reading the source code.

It may surprise you that one of the most important parts of a program has absolutely no impact on the way it runs. In fact, the compiler ignores this part of a program. Of course, I'm speaking of the comments.

As a beginning programmer, you might be resistant to the idea of liberally writing comments in your programs. After all, it can seem more productive to write code that actually does something! It is crucial, however, that you develop the habit of thoroughly annotating your code with descriptive comments. It might take extra time now, but it will almost certainly save time in the future.

Imagine writing a program of medium complexity with about 8,000 to 10,000 lines of C++ code. Once you have written the code and

satisfactorily debugged it, you happily put it away and move on to the next project. Ten months later, you are asked to make a modification to the program (or worse, track down and fix an elusive bug). You open the file that contains your source code and stare at thousands of statements that now make no sense at all. If only you had left some notes to yourself explaining the program's code. Of course it's too late now. All that's left to do is decide what will take less time: figuring out the old program, or completely rewriting it!

This scenario might sound extreme, but it's one you don't want to happen to you. Real-world programs are big and complex. Thoroughly documented code will make your life easier, not to mention the other programmers who may have to read your code in the future.



# Single-Line Comments

You have already seen one way to place comments in a C++ program. You simply place two forward slashes ( `//` ) where you want the comment to begin. The compiler ignores everything from that point to the end of the line. [Program 2-26](#) shows that comments may be placed liberally throughout a program.


## Program 2-26

```
1 // PROGRAM: PAYROLL.CPP
2 // Written by Herbert Dorfmann
3 // This program calculates company payroll
4 // Last modification: 8/20/2017
5 #include <iostream>
6 using namespace std;
7
8 int main()
9 {
10     double payRate; // Holds the hourly pay
rate
11     double hours; // Holds the hours worked
12     int employNumber; // Holds the employee
number
    (The remainder of this program is left out.)
```

In addition to telling who wrote the program and describing the purpose of variables, comments can also be used to explain complex procedures in your code.

# Multi-Line Comments

The second type of comment in C++ is the multi-line comment. *Multi-line comments* start with `/*` (a forward slash followed by an asterisk) and end with `*/` (an asterisk followed by a forward slash).

Everything between these markers is ignored. [Program 2-27](#)  illustrates how multi-line comments may be used. Notice a multi-line comment starts in line 1 with the `/*` symbol, and it ends in line 6 with the `*/` symbol.

## Program 2-27

```
1  /*
2     PROGRAM: PAYROLL.CPP
3     Written by Herbert Dorfmann
4     This program calculates company payroll
5     Last modification: 8/20/2017
6  */
7
8  #include <iostream>
9  using namespace std;
10
11  int main()
12  {
13     double payRate;    // Holds the hourly
pay rate
14     double hours;    // Holds the hours
worked
15     int employNumber; // Holds the employee
number
    (The remainder of this program is left out.)
```

Unlike a comment started with `/**`, a multi-line comment can span several lines. This makes it more convenient to write large blocks of comments because you do not have to mark every line.

Consequently, the multi-line comment is inconvenient for writing single-line comments because you must type both a beginning and ending comment symbol.



**Note:**

Many programmers use a combination of single-line comments and multi-line comments in their programs. Convenience usually dictates which style to use.

Remember the following advice when using multi-line comments:

- Be careful not to reverse the beginning symbol with the ending symbol.
- Be sure not to forget the ending symbol.

Both of these mistakes can be difficult to track down and will prevent the program from compiling correctly.

## 2.16 Named Constants

### **Concept:**

Literals may be given names that symbolically represent them in a program.

Assume the following statement appears in a banking program that calculates data pertaining to loans:

```
amount = balance * 0.069;
```

In such a program, two potential problems arise. First, it is not clear to anyone other than the original programmer what 0.069 is. It appears to be an interest rate, but in some situations there are fees associated with loan payments. How can the purpose of this statement be determined without painstakingly checking the rest of the program?

The second problem occurs if this number is used in other calculations throughout the program and must be changed

periodically. Assuming the number is an interest rate, what if the rate changes from 6.9 percent to 7.2 percent? The programmer will have to search through the source code for every occurrence of the number.

Both of these problems can be addressed by using named constants. A *named constant* is like a variable, but its content is read-only and cannot be changed while the program is running. Here is a definition of a named constant:

```
const double INTEREST_RATE = 0.069;
```

It looks just like a regular variable definition except that the word `const` appears before the data type name, and the name of the variable is written in all uppercase characters. The key word `const` is a qualifier that tells the compiler to make the variable read-only. Its value will remain constant throughout the program's execution. It is not required that the variable name be written in all uppercase characters, but many programmers prefer to write them this way so that they are easily distinguishable from regular variable names.

An initialization value must be given when defining a constant with the `const` qualifier, or an error will result when the program is compiled. A compiler error will also result if there are any statements in the program that attempt to change the value of a named constant.

An advantage of using named constants is that they make programs more self-documenting. The statement

```
amount = balance * 0.069;
```

can be changed to read

```
amount = balance * INTEREST_RATE;
```


A new programmer can read the second statement and know what is happening. It is evident that `balance` is being multiplied by the interest rate. Another advantage to this approach is that widespread changes can easily be made to the program. Let's say the interest rate appears in a dozen different statements throughout the program. When the rate changes, the initialization value in the definition of the named constant is the only value that needs to be modified. If the rate increases to 7.2 percent, the definition is changed to the following:

```
const double INTEREST_RATE = 0.072;
```

The program is then ready to be recompiled. Every statement that uses `INTEREST_RATE` will then use the new value.



Named constants can also help prevent typographical errors in a program's code. For example, suppose you use the number 3.14159 as the value of  $\pi$  in a program that performs various geometric calculations. Each time you type the number 3.14159 in the program's code, there is a chance that you will make a mistake with one or more of the digits. As a result, the program will not produce the correct results. To help prevent a mistake such as this, you can define a named constant for  $\pi$ , initialized with the correct value, then use that constant in all of the formulas that require its value.

**Program 2-28**  shows an example. It calculates the circumference of a circle that has a diameter of 10.

## Program 2-28

```
1 // This program calculates the circumference
of a circle.
2 #include <iostream>
3 using namespace std;
4
5 int main()
6 {
7     // Constants
8     const double PI = 3.14159;
9     const double DIAMETER = 10.0;
10
11     // Variable to hold the circumference
12     double circumference;
13
14     // Calculate the circumference.
15     circumference = PI * DIAMETER;
16
17     // Display the circumference.
18     cout << "The circumference is: " <<
circumference << endl;
19     return 0;
20 }
```

## Program Output

```
The circumference is: 31.4159
```

Let's take a closer look at the program. Line 8 defines a constant `double` named `PI`, initialized with the value 3.14159. This constant will be used for the value of  $\pi$  in the program's calculation. Line 9 defines a constant `double` named `DIAMETER`, initialized with the value 10. This will be used for the circle's diameter. Line 12 defines a `double` variable named `circumference`, which will be used to hold the circle's circumference. Line 15 calculates the circle's circumference by multiplying `PI` by `DIAMETER`. The result of the calculation is assigned to the `circumference` variable. Line 18 displays the circle's circumference.

## Checkpoint

2.25 Write statements using the `const` qualifier to create named constants for the following literal values:

## 2.17 Programming Style

### Concept:

Programming style refers to the way a programmer uses identifiers, spaces, tabs, blank lines, and punctuation characters to visually arrange a program's source code. These are some, but not all, of the elements of programming style.

In [Chapter 1](#), you learned that syntax rules govern the way a language may be used. The syntax rules of C++ dictate how and where to place key words, semicolons, commas, braces, and other components of the language. The compiler's job is to check for syntax errors and, if there are none, generate object code.


When the compiler reads a program, it processes it as one long stream of characters. The compiler doesn't care that each statement is on a separate line, or that spaces separate operators from operands. Humans, on the other hand, find it difficult to read programs that aren't written in a visually pleasing manner. Consider [Program 2-29](#) for example.

## Program 2-29


```
1  #include <iostream>
2  using namespace std;int main(){double
shares=220.0;
3  double avgPrice=14.67;cout<<"There were "
<<shares
4  <<" shares sold at $"<<avgPrice<<" per
share.\n";
5  return 0;}
```

## Program Output

```
There were 220 shares sold at $14.67 per
share.
```

Although the program is syntactically correct (it doesn't violate any rules of C++), it is very difficult to read. The same program is shown in [Program 2-30](#) , written in a more reasonable style.


## Program 2-30

```
1 // This example is much more readable than
Program 2-29 .
2 #include <iostream>
3 using namespace std;
4
5 int main()
6 {
7     double shares = 220.0;
8     double avgPrice = 14.67;
9
10    cout << "There were " << shares << "
shares sold at $";
11    cout << avgPrice << " per share.\n";
12    return 0;
13 }
```

## Program Output

```
There were 220 shares sold at $14.67 per  
share.
```

Programming style refers to the way source code is visually arranged. Ideally, it is a consistent method of putting spaces and indentions in a program so visual cues are created. These cues quickly tell a programmer important information about a program.

For example, notice in [Program 2-30](#)  that inside the function `main`'s braces each line is indented. It is a common C++ style to indent all the lines inside a set of braces. You will also notice the blank line between the variable definitions and the `cout` statements. This is intended to visually separate the definitions from the executable statements.



### Note:

Although you are free to develop your own style, you should adhere to common programming practices. By doing so, you will write programs that visually make sense to other programmers.

Another aspect of programming style is how to handle statements that are too long to fit on one line. Because C++ is a free-flowing language, it is usually possible to spread a statement over several lines. For example, here is a `cout` statement that uses five lines:

```
cout << "The Fahrenheit temperature is "  
    << fahrenheit  
    << " and the Celsius temperature is "  
    << celsius  
    << endl;
```

This statement will work just as if it were typed on one line. Here is an example of variable definitions treated similarly:

```
int fahrenheit,  
    celsius,  
    kelvin;
```

There are many other issues related to programming style. They will be presented throughout the book.



# Review Questions and Exercises

## Short Answer

1. How many operands does each of the following types of operators require?  
\_\_\_ Unary  
\_\_\_ Binary  
\_\_\_ Ternary
2. How may the `double` variables `temp`, `weight`, and `age` be defined in one statement?
3. How may the `int` variables `months`, `days`, and `years` be defined in one statement, with `months` initialized to 2 and `years` initialized to 3?
4. Write assignment statements that perform the following operations with the variables `a`, `b`, and `c`:
  - A. Adds 2 to `a` and stores the result in `b`.
  - B. Multiplies `b` by 4 and stores the result in `a`.
  - C. Divides `a` by 3.14 and stores the result in `b`.
  - D. Subtracts 8 from `b` and stores the result in `a`.
  - E. Stores the value 27 in `a`.

F. Stores the character 'K' in `c`.

G. Stores the ASCII code for 'B' in `c`.

5. Is the following comment written using single-line or multi-line comment symbols?

```
/* This program was written by M. A. Codewriter*/
```

6. Is the following comment written using single-line or multi-line comment symbols?

```
// This program was written by M. A. Codewriter
```

7. Modify the following program so it prints two blank lines between each line of text.

```
#include <iostream>
using namespace std;
int main()
{
    cout << "Two mandolins like creatures in the";
    cout << "dark";
    cout << "Creating the agony of ecstasy.";
    cout << "                - George Barker";
    return 0;
}
```

## 8. What will the following programs print on the screen?

A.

```
#include <iostream>
using namespace std;
int main()
{
    int freeze = 32, boil = 212;
    freeze = 0;
    boil = 100;
    cout << freeze << endl << boil << endl;
    return 0;
}
```

B.

```
#include <iostream>
using namespace std;
int main()
{
    int x = 0, y = 2;
    x = y * 4;
    cout << x << endl << y << endl;
    return 0;
}
```

C.

```
#include <iostream>
using namespace std;
int main()
{
    cout << "I am the incredible";
    cout << "computing\nmachine";
    cout << "\nand I will\namaze\n";
    cout << "you.";
    return 0;
}
```

D.

```
#include <iostream>
using namespace std;
int main()
{
    cout << "Be careful\n";
    cout << "This might/\n be a trick ";
    cout << "question\n";
    return 0;
}
```

E.

```
#include <iostream>
using namespace std;
int main()
{
    int a, x = 23;
    a = x % 2;
    cout << x << endl << a << endl;
    return 0;
}
```

# Multiple Choice

9. Every complete statement ends with a(n) \_\_\_\_\_.

- A. `period`
- B. `# symbol`
- C. `semicolon`
- D. `ending brace`

10. Which of the following statements is correct?

- A. `#include (iostream)`
- B. `#include {iostream}`
- C. `#include <iostream>`
- D. `#include [iostream]`
- E. All of the above

11. Every C++ program must have a \_\_\_\_\_.

- A. `cout` statement
- B. function `main`
- C. `#include` statement
- D. All of the above

12. Preprocessor directives begin with \_\_\_\_\_.

- A. `#`
- B. `!`
- C. `<`
- D. `*`

E. None of the above

13. The following data

```
72
'A'
"Hello World"
2.8712
```

are all examples of \_\_\_\_\_.

- A. variables
- B. literals or constants
- C. strings
- D. none of the above

14. A group of statements, such as the contents of a function, is enclosed in \_\_\_\_\_.

- A. braces `{ }`
- B. parentheses `( )`
- C. brackets `< >`
- D. all of the above will do

15. Which of the following are *not* valid assignment statements?

(Select all that apply.)

- A. `total = 9;`
- B. `72 = amount;`
- C. `profit = 129`
- D. `letter = 'W';`

16. Which of the following are *not* valid `cout` statements? (Select all that apply.)

- A. `cout << "Hello World ";`
- B. `cout << "Have a nice day "\n;`
- C. `cout < value;`
- D. `cout << Programming is great fun;`

17. Assume `w = 5`, `x = 4`, `y = 8`, and `z = 2`. What value will be stored in `result` in each of the following statements?

- A. `result = x + y;`
- B. `result = z * 2;`
- C. `result = y / x;`
- D. `result = y - z;`
- E. `result = w % 2;`

18. How would each of the following numbers be represented in E notation?

- A.  $3.287 \times 10^6$
- B.  $-978.65 \times 10^{12}$
- C.  $7.65491 \times 10^{-3}$
- D.  $-58710.23 \times 10^{-4}$

19. The negation operator is \_\_\_\_\_.

- A. unary
- B. binary
- C. ternary
- D. none of the above



20. A(n) \_\_\_\_\_ is like a variable, but its value is read-only and cannot be changed during the program's execution.
- A. secure variable
  - B. uninitialized variable
  - C. named constant
  - D. locked variable
21. When do preprocessor directives execute?
- A. Before the compiler compiles your program
  - B. After the compiler compiles your program
  - C. At the same time as the compiler compiles your program
  - D. None of the above

## True or False

22. T F A variable must be defined before it can be used.
23. T F Variable names may begin with a number.
24. T F Variable names may be up to 31 characters long.
25. T F A left brace in a C++ program should always be followed by a right brace later in the program.
26. T F You cannot initialize a named constant that is declared with the `const` modifier.

# Algorithm Workbench

27. Convert the following pseudocode to C++ code. Be sure to define the appropriate variables.

Store 20 in the `speed` variable.

Store 10 in the `time` variable.

Multiply `speed` by `time` and store the result in the `distance` variable.

Display the contents of the `distance` variable.

28. Convert the following pseudocode to C++ code. Be sure to define the appropriate variables.

Store 172.5 in the `force` variable.

Store 27.5 in the `area` variable.

Divide `area` by `force` and store the result in the `pressure` variable.

Display the contents of the `pressure` variable.

# Find the Error

29. There are a number of syntax errors in the following program. Locate as many as you can.

```
*/ What's wrong with this program? /*  
#include iostream  
using namespace std;  
int main();  
}  
int a, b, c \\ Three integers  
a = 3  
b = 4  
c = a + b  
Cout < "The value of c is %d" < C;  
return 0;  
{
```

# Programming Challenges

Visit [www.myprogramminglab.com](http://www.myprogramminglab.com) to complete many of these Programming Challenges online and get instant feedback.

## 1. Sum of Two Numbers

Write a program that stores the integers 50 and 100 in variables, and stores the sum of these two in a variable named `total`.

## 2. Sales Prediction

The East Coast sales division of a company generates 58 percent of total sales. Based on that percentage, write a program that will predict how much the East Coast division will generate if the company has \$8.6 million in sales this year.

## 3. Sales Tax

Write a program that will compute the total sales tax on a \$95 purchase. Assume the state sales tax is 4 percent, and the county sales tax is 2 percent.



## Solving the Restaurant Bill Problem

### 4. Restaurant Bill

Write a program that computes the tax and tip on a restaurant bill for a patron with a \$88.67 meal charge. The tax should be 6.75 percent of the meal cost. The tip should be 20 percent of the total after adding the tax. Display the meal cost, tax amount, tip amount, and total bill on the screen.

### 5. Average of Values

To get the average of a series of values, you add the values up then divide the sum by the number of values. Write a program that stores the following values in five different variables: 28, 32, 37, 24, and 33. The program should first calculate the sum of these five variables and store the result in a separate variable named `sum`. Then, the program should divide the `sum` variable by 5 to get the average. Display the average on the screen.



#### Tip:

Use the `double` data type for all variables in this program.

## 6. Annual Pay

Suppose an employee gets paid every two weeks and earns \$2,200 each pay period. In a year, the employee gets paid 26 times. Write a program that defines the following variables:  
The program should calculate the employee's total annual pay by multiplying the employee's pay amount by the number of pay periods in a year and store the result in the `annualPay` variable. Display the total annual pay on the screen.

## 7. Ocean Levels

Assuming the ocean's level is currently rising at about 1.5 millimeters per year, write a program that displays:

- The number of millimeters higher than the current level that the ocean's level will be in 5 years.
- The number of millimeters higher than the current level that the ocean's level will be in 7 years.
- The number of millimeters higher than the current level that the ocean's level will be in 10 years.

## 8. Total Purchase

A customer in a store is purchasing five items. The prices of the five items are as follows:

Price of item 1 = \$15.95

Price of item 2 = \$24.95

Price of item 3 = \$6.95

Price of item 4 = \$12.95

Price of item 5 = \$3.95

Write a program that holds the prices of the five items in five variables. Display each item's price, the subtotal of the sale, the amount of sales tax, and the total. Assume the sales tax is 7 percent.

### 9. **Cyborg Data Type Sizes**

You have been given a job as a programmer on a Cyborg supercomputer. In order to accomplish some calculations, you need to know how many bytes the following data types use: `char`, `int`, `float`, and `double`. You do not have any technical documentation, so you can't look this information up. Write a C++ program that will determine the amount of memory used by these types and display the information on the screen.

### 10. **Miles per Gallon**

A car holds 15 gallons of gasoline and can travel 375 miles before refueling. Write a program that calculates the number of miles per gallon the car gets. Display the result on the screen.

*Hint:* Use the following formula to calculate miles per gallon (MPG):

$$\text{MPG} = \frac{\text{Miles Driven}}{\text{Gallons of Gas Used}}$$

### 11. **Distance per Tank of Gas**

A car with a 20-gallon gas tank averages 23.5 miles per gallon when driven in town, and 28.9 miles per gallon when driven on the highway. Write a program that calculates and displays the distance the car can travel on one tank of gas when driven in town and when driven on the highway.

*Hint:* The following formula can be used to calculate the distance:

Distance = Number of Gallons \* Average Miles per Gallon

## 12. Land Calculation

One acre of land is equivalent to 43,560 square feet. Write a program that calculates the number of acres in a tract of land with 391,876 square feet.

## 13. Circuit Board Price

An electronics company sells circuit boards at a 35 percent profit. Write a program that will calculate the selling price of a circuit board that costs \$14.95. Display the result on the screen.

## 14. Personal Information

Write a program that displays the following pieces of information, each on a separate line:

Your name

Your address, with city, state, and ZIP code

Your telephone number

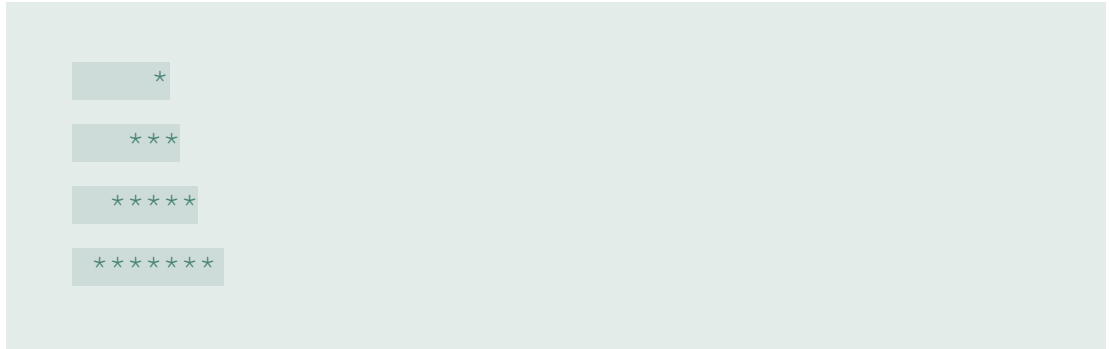
Your college major

Use only a single `cout` statement to display all of this information.

## 15. Triangle Pattern

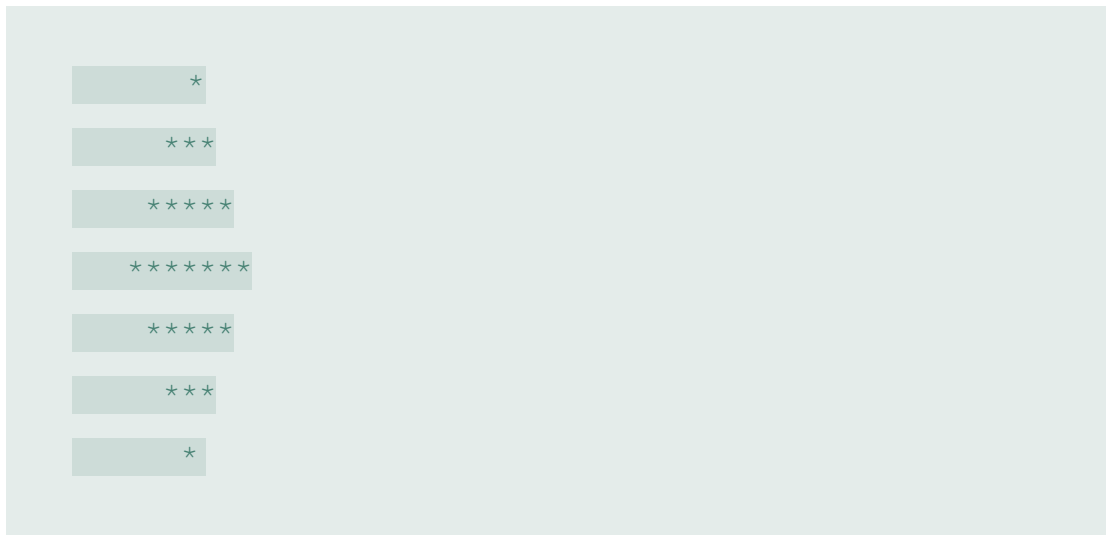
Write a program that displays the following pattern on the screen:





## 16. Diamond Pattern

Write a program that displays the following pattern:



## 17. Stock Commission

Kathryn bought 750 shares of stock at a price of \$35.00 per share. She must pay her stockbroker a 2 percent commission for the transaction. Write a program that calculates and displays the following:

- The amount paid for the stock alone (without the commission).
- The amount of the commission.
- The total amount paid (for the stock plus the commission).

## 18. Energy Drink Consumption

A soft drink company recently surveyed 16,500 of its customers and found that approximately 15 percent of those surveyed purchase one or more energy drinks per week. Of those customers who purchase energy drinks, approximately 58 percent of them prefer citrus-flavored energy drinks. Write a program that displays the following:

- The approximate number of customers in the survey who purchase one or more energy drinks per week.
- The approximate number of customers in the survey who prefer citrus-flavored energy drinks.

#### 19. **Annual High Temperatures**

The average July high temperature is 85 degrees Fahrenheit in New York City, 88 degrees Fahrenheit in Denver, and 106 degrees Fahrenheit in Phoenix. Write a program that calculates and reports what the new average July high temperature would be for each of these cities if temperatures rise by 2 percent.

#### 20. **How Much Paint**

A particular brand of paint covers 340 square feet per gallon. Write a program to determine and report approximately how many gallons of paint will be needed to paint two coats on a wooden fence that is 6 feet high and 100 feet long.

---

# Chapter 3 Expressions and Interactivity

---

## Topics

3.1 The `cin` Object [□](#)

3.2 Mathematical Expressions [□](#)

3.3 When You Mix Apples and Oranges: Type Conversion [□](#)

3.4 Overflow and Underflow [□](#)

3.5 Type Casting [□](#)

3.6 Multiple Assignment and Combined Assignment [□](#)

3.7 Formatting Output [□](#)

3.8 Working with Characters and `string` Objects [□](#)

3.9 More Mathematical Library Functions [□](#)

3.10 Focus on Debugging: Hand Tracing a Program [□](#)

3.11 Focus on Problem Solving: A Case Study [□](#)

## 3.1 The `cin` Object

### Concept:

The `cin` object can be used to read data typed at the keyboard.

So far you have written programs with built-in data. Without giving the user an opportunity to enter his or her own data, you have initialized the variables with the necessary starting values. These types of programs are limited to performing their task with only a single set of starting data. If you decide to change the initial value of any variable, the program must be modified and recompiled.



### Reading Input with `cin`

In reality, most programs ask for values that will be assigned to variables. This means the program does not have to be modified if the user wants to run it several times with different sets of data. For example, a program that calculates payroll for a small business might ask the user to enter the name of the employee, the hours worked, and the hourly pay rate. When the paycheck for that employee has been printed, the program could start over again and ask for the name, hours worked, and hourly pay rate of the next employee.

Just as `cout` is C++'s standard output object, `cin` is the standard input object. It reads input from the console (or keyboard) as shown in [Program 3-1](#) .

## Program 3-1

```
1 // This program asks the user to enter the length and width of
2 // a rectangle. It calculates the rectangle's area and displays
3 // the value on the screen.
4 #include <iostream>
5 using namespace std;
6
7 int main()
8 {
9     int length, width, area;
10
11     cout << "This program calculates the area of a ";
12     cout << "rectangle.\n";
13     cout << "What is the length of the rectangle? ";
14     cin >> length;
15     cout << "What is the width of the rectangle? ";
16     cin >> width;
17     area = length * width;
18     cout << "The area of the rectangle is " << area << ".\n";
19     return 0;
20 }
```

### Program Output with Example Input Shown in Bold

```
This program calculates the area of a rectangle.
What is the length of the rectangle? 10 Enter
What is the width of the rectangle? 20 Enter
The area of the rectangle is 200.
```

Instead of calculating the area of one rectangle, this program can be used to get the area of any rectangle. The values that are stored in the `length` and `width` variables are entered by the user when the program is running. Look at lines 13 and 14:

```
cout << "What is the length of the rectangle? ";  
cin >> length;
```

In line 13, the `cout` object is used to display the question “What is the length of the rectangle?” This question is known as a *prompt*, and it tells the user what data he or she should enter. Your program should always display a prompt before it uses `cin` to read input. This way, the user will know that he or she must type a value at the keyboard.

Line 14 uses the `cin` object to read a value from the keyboard. The `>>` symbol is the *stream extraction operator*. It gets characters from the stream object on its left and stores them in the variable whose name appears on its right. In this line, characters are taken from the `cin` object (which gets them from the keyboard) and are stored in the `length` variable.

Gathering input from the user is normally a two-step process:

1. Use the `cout` object to display a prompt on the screen.
2. Use the `cin` object to read a value from the keyboard.

The prompt should ask the user a question, or tell the user to enter a specific value. For example, the code we just examined from [Program 3-1](#) displays the following prompt:

```
What is the length of the rectangle?
```

When the user sees this prompt, he or she knows to enter the rectangle’s length. After the prompt is displayed, the program uses the `cin` object to read a value from the keyboard and store the value in the `length` variable.

Notice the `<<` and `>>` operators appear to point in the direction that data is flowing. In a statement that uses the `cout` object, the `<<` operator always points toward `cout`. This indicates that data is flowing from a variable or a literal to the `cout` object. In a statement that uses the `cin` object, the `>>` operator always points toward the variable that is receiving the value. This indicates that data is flowing from `cin` to a variable. This is illustrated in [Figure 3-1](#).

Figure 3-1 The << and >> operators

```
cout << "What is the length of the rectangle? ";  
cin >> length;
```

Think of the << and >> operators as arrows that point in the direction that data is flowing.

```
cout ← "What is the length of the rectangle? ";  
cin → length;
```

The `cin` object causes a program to wait until data is typed at the keyboard and the `Enter` key is pressed. No other lines in the program will be executed until `cin` gets its input.

`cin` automatically converts the data read from the keyboard to the data type of the variable used to store it. If the user types 10, it is read as the characters '1' and '0'. `cin` is smart enough to know this will have to be converted to an `int` value before it is stored in the `length` variable. `cin` is also smart enough to know a value like 10.7 cannot be stored in an integer variable. If the user enters a floating-point value for an integer variable, `cin` will not read the part of the number after the decimal point.



**Note:**

You must include the `<iostream>` header file in any program that uses `cin`.

# Entering Multiple Values

The `cin` object may be used to gather multiple values at once. Look at [Program 3-2](#), which is a modified version of [Program 3-1](#).

## Program 3-2

```
1 // This program asks the user to enter the length and width of
2 // a rectangle. It calculates the rectangle's area and displays
3 // the value on the screen.
4 #include <iostream>
5 using namespace std;
6
7 int main()
8 {
9     int length, width, area;
10
11     cout << "This program calculates the area of a ";
12     cout << "rectangle.\n";
13     cout << "Enter the length and width of the rectangle ";
14     cout << "separated by a space.\n";
15     cin >> length >> width;
16     area = length * width;
17     cout << "The area of the rectangle is " << area << endl;
18     return 0;
19 }
```

## Program Output with Example Input Shown in Bold

```
This program calculates the area of a rectangle.
Enter the length and width of the rectangle separated by a space.
10 20 Enter
The area of the rectangle is 200
```



Line 15 waits for the user to enter two values. The first is assigned to `length` and the second to `width`.

```
cin >> length >> width;
```

In the example output, the user entered 10 and 20, so 10 is stored in `length` and 20 is stored in `width`.

Notice the user separates the numbers by spaces as they are entered. This is how `cin` knows where each number begins and ends. It doesn't matter how many spaces are entered between the individual numbers. For example, the user could have entered

```
10      20
```



**Note:**

The `Enter` key is pressed after the last number is entered.

`cin` will also read multiple values of different data types. This is shown in [Program 3-3](#).

## Program 3-3

```
1 // This program demonstrates how cin can read multiple values
2 // of different data types.
3 #include <iostream>
4 using namespace std;
5
6 int main()
7 {
8     int whole;
9     double fractional;
10    char letter;
11
12    cout << "Enter an integer, a double, and a character: ";
13    cin >> whole >> fractional >> letter;
14    cout << "Whole: " << whole << endl;
15    cout << "Fractional: " << fractional << endl;
16    cout << "Letter: " << letter << endl;
17    return 0;
18 }
```

### Program Output with Example Input Shown in Bold

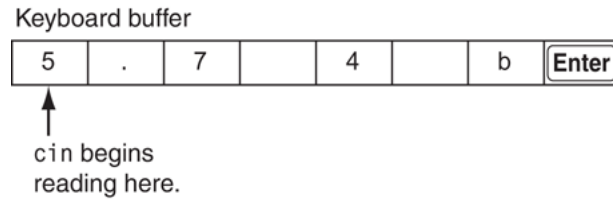
```
Enter an integer, a double, and a character: 4 5.7 b Enter
Whole: 4
Fractional: 5.7
Letter: b
```

As you can see in the example output, the values are stored in their respective variables. But what if the user had responded in the following way?

```
Enter an integer, a double, and a character: 5.7 4 b Enter
```

When the user types values at the keyboard, those values are first stored in an area of memory known as the *keyboard buffer*. So, when the user enters the values 5.7, 4, and b, they are stored in the keyboard buffer as shown in [Figure 3-2](#).

**Figure 3-2 The keyboard buffer**



When the user presses the `Enter` key, `cin` reads the value 5 into the variable `whole`. It does not read the decimal point because `whole` is an integer variable. Next it reads `.7` and stores that value in the `double` variable `fractional`. The space is skipped, and 4 is the next value read. It is stored as a character in the variable `letter`. Because this `cin` statement reads only three values, the b is left in the keyboard buffer. So, in this situation the program would have stored 5 in `whole`, 0.7 in `fractional`, and the character '4' in `letter`. It is important that the user enters values in the correct order.



3.1 What header file must be included in programs using `cin`?

3.2 True or false: `cin` requires the user to press the `Enter` key when finished entering data.

3.3 Assume `value` is an integer variable. If the user enters 3.14 in response to the following programming statement, what will be stored in `value`?

```
cin >> value;
```

- A. 3.14
- B. 3
- C. 0
- D. Nothing. An error message is displayed.

3.4 A program has the following variable definitions.

```
long miles;  
int feet;  
float inches;
```

Write one `cin` statement that reads a value into each of these variables.

3.5 The following program will run, but the user will have difficulty understanding what to do. How would you improve the program?

```
// This program multiplies two numbers and displays the result.  
#include <iostream>  
using namespace std;  
int main()  
{  
    double first, second, product;  
  
    cin >> first >> second;  
    product = first * second;  
    cout << product;  
    return 0;  
}
```

3.6 Complete the following program skeleton so it asks for the user's weight (in pounds) and displays the equivalent weight in kilograms.

```
#include <iostream>
using namespace std;
int main()
{
    double pounds, kilograms;

    // Write code here that prompts the user
    // to enter his or her weight and reads
    // the input into the pounds variable.

    // The following line does the conversion.
    kilograms = pounds / 2.2;

    // Write code here that displays the user's weight
    // in kilograms.
    return 0;
}
```

## 3.2 Mathematical Expressions

### Concept:

C++ allows you to construct complex mathematical expressions using multiple operators and grouping symbols.

In [Chapter 2](#), you were introduced to the basic mathematical operators, which are used to build mathematical expressions. An *expression* is a programming statement that has a value. Usually, an expression consists of an operator and its operands. Look at the following statement:

```
sum = 21 + 3;
```


Since  $21 + 3$  has a value, it is an expression. Its value, 24, is stored in the variable `sum`. Expressions do not have to be in the form of mathematical operations. In the following statement, 3 is an expression.

```
number = 3;
```

Here are some programming statements where the variable `result` is being assigned the value of an expression:

```
result = x;  
result = 4;  
result = 15 / 3;  
result = 22 * number;  
result = sizeof(int);  
result = a + b + c;
```

In each of these statements, a number, variable name, or mathematical expression appears on the right side of the `=` symbol. A value is obtained from each of these and stored in the variable `result`. These are all examples of a variable being assigned the value of an expression.

**Program 3-4**  shows how mathematical expressions can be used with the `cout` object.

## Program 3-4


```
1 // This program asks the user to enter the
numerator
2 // and denominator of a fraction and it
displays the
3 // decimal value.
4
5 #include <iostream>
6 using namespace std;
7
8 int main()
9 {
10     double numerator, denominator;
11
12     cout << "This program shows the decimal
value of ";
13     cout << "a fraction.\n";
14     cout << "Enter the numerator: ";
15     cin >> numerator;
16     cout << "Enter the denominator: ";
17     cin >> denominator;
18     cout << "The decimal value is ";
19     cout << (numerator / denominator) << endl;
```



```
20     return 0;
21 }
```


### Program Output with Example Input Shown in Bold

```
This program shows the decimal value of a
fraction.
Enter the numerator: 3 Enter
Enter the denominator: 16 Enter
The decimal value is 0.1875
```

The `cout` object will display the value of any legal expression in C++. In **Program 3-4** , the value of the expression `numerator / denominator` is displayed.



#### Note:

The example input for **Program 3-4**  shows the user entering 3 and 16. Since these values are assigned to `double` variables, they are stored as the `double` values 3.0 and 16.0.



## Note:

When sending an expression that consists of an operator to `cout`, it is always a good idea to put parentheses around the expression. Some advanced operators will yield unexpected results otherwise.

# Operator Precedence

It is possible to build mathematical expressions with several operators. The following statement assigns the sum of 17, `x`, 21, and `y` to the variable `answer`.

```
answer = 17 + x + 21 + y;
```

Some expressions are not that straightforward, however. Consider the following statement:

```
outcome = 12 + 6 / 3;
```


What value will be stored in `outcome`? 6 is used as an operand for both the addition and division operators. `outcome` could be assigned either 6 or 14, depending on whether the addition operation or the division operation takes place first. The answer is 14 because the division operator has higher *precedence* than the addition operator.

Mathematical expressions are evaluated from left to right. When two operators share an operand, the operator with the highest precedence works first. Multiplication and division have higher precedence than addition and subtraction, so the statement above works like this:


- A. 6 is divided by 3, yielding a result of 2
- B. 12 is added to 2, yielding a result of 14

It could be diagrammed in the following way:

```
outcome = 12 + 6 / 3
           \ /
outcome = 12 + 2
outcome = 14
```

**Table 3-1**  shows the precedence of the arithmetic operators. The operators at the top of the table have higher precedence than the ones below them.

### **Table 3-1 Precedence of Arithmetic Operators (Highest to Lowest)**

The multiplication, division, and modulus operators have the same precedence. This is also true of the addition and subtraction operators. **Table 3-2**  shows some expressions with their values.

### **Table 3-2 Some Simple Expressions and Their Values**

# Associativity

An operator's *associativity* is either left to right, or right to left. If two operators sharing an operand have the same precedence, they work according to their associativity. [Table 3-3](#) lists the associativity of the arithmetic operators. As an example, look at the following expression:

**Table 3-3 Associativity of Arithmetic Operators**

```
5 - 3 + 2
```

Both the `-` and `+` operators in this expression have the same precedence, and they have left to right associativity. So, the operators will work from left to right. This expression is the same as:

```
((5 - 3) + 2)
```

Here is another example:

```
12 / 6 * 4
```

Because the `/` and `*` operators have the same precedence, and they have left to right associativity, they will work from left to right. This expression is the same as:

```
((12 / 6) * 4)
```

## Grouping with Parentheses

Parts of a mathematical expression may be grouped with parentheses to force some operations to be performed before others. In the following statement, the sum of `a + b` is divided by 4.

```
result = (a + b) / 4;
```

Without the parentheses, however, `b` would be divided by 4 and the result added to `a`. [Table 3-4](#) shows more expressions and their values.

### Table 3-4 More Simple Expressions and Their Values

# Converting Algebraic Expressions to Programming Statements

In algebra, it is not always necessary to use an operator for multiplication. C++, however, requires an operator for any mathematical operation. [Table 3-5](#) shows some algebraic expressions that perform multiplication and the equivalent C++ expressions.

## Table 3-5 Algebraic and C++ Multiplication Expressions

When converting some algebraic expressions to C++, you may have to insert parentheses that do not appear in the algebraic expression. For example, look at the following expression:

$$x = \frac{a + b}{c}$$

To convert this to a C++ statement,  $a + b$  will have to be enclosed in parentheses:

```
x = (a + b) / c;
```

[Table 3-6](#) shows more algebraic expressions and their C++ equivalents.

**Table 3-6 Algebraic and C++ Expressions**



# No Exponents Please!

Unlike many programming languages, C++ does not have an exponent operator. Raising a number to a power requires the use of a *library function*. The C++ library isn't a place where you check out books, but a collection of specialized functions. Think of a library function as a "routine" that performs a specific operation. One of the library functions is called `pow`, and its purpose is to raise a number to a power. Here is an example of how it's used:

```
area = pow(4.0, 2.0);
```


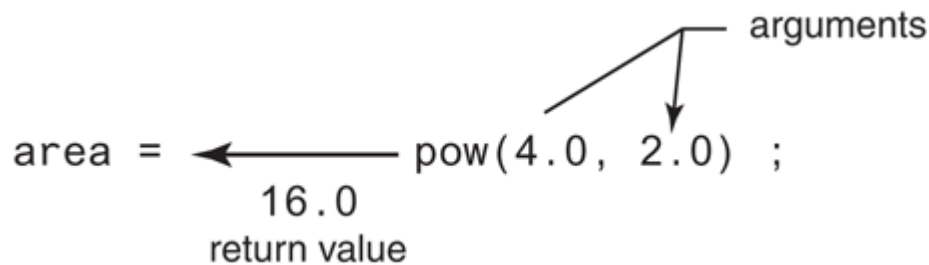
This statement contains a *call* to the `pow` function. The numbers inside the parentheses are *arguments*. Arguments are data being sent to the function. The `pow` function always raises the first argument to the power of the second argument. In this example, 4 is raised to the power of 2. The result is *returned* from the function and used in the statement where the function call appears. In this case, the value 16 is returned from `pow` and assigned to the variable `area`. This is illustrated in [Figure 3-3](#) .

Figure 3-3 The `pow` function



The statement `area = pow(4.0, 2.0)` is equivalent to the following algebraic statement:

```
area = 42
```

Here is another example of a statement using the `pow` function. It assigns 3 times 6<sup>3</sup> to `x`:

```
x = 3 * pow(6.0, 3.0);
```

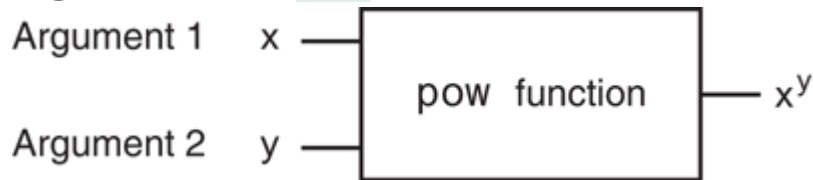
And the following statement displays the value of 5 raised to the power of 4:

```
cout << pow(5.0, 4.0);
```

It might be helpful to think of `pow` as a “black box” that you plug two numbers into, and that then sends a third number out. The number

that comes out has the value of the first number raised to the power of the second number, as illustrated in [Figure 3-4](#):

**Figure 3-4** The `pow` function as a “black box”



There are some guidelines that should be followed when the `pow` function is used. First, the program must include the `<cmath>` header file. Second, the arguments that you pass to the `pow` function should be `double`s. Third, the variable used to store `pow`'s return value should be defined as a `double`. For example, in the following statement the variable `area` should be a `double`:

```
area = pow(4.0, 2.0);
```

**Program 3-5** solves a simple algebraic problem. It asks the user to enter the radius of a circle and then calculates the area of the circle. The formula is

## Program 3-5

```
1 // This program calculates the area of a
circle.
2 // The formula for the area of a circle is Pi
times
3 // the radius squared. Pi is 3.14159.
4 #include <iostream>
5 #include <cmath> // needed for pow function
6 using namespace std;
7
8 int main()
9 {
10     const double PI = 3.14159;
11     double area, radius;
12
13     cout << "This program calculates the area
of a circle.\n";
14     cout << "What is the radius of the circle?
";
15     cin >> radius;
16     area = PI * pow(radius, 2.0);
17     cout << "The area is " << area << endl;
```

```
18     return 0;
19 }
```

### Program Output with Example Input Shown in Bold

```
This program calculates the area of a
circle.
What is the radius of the circle? 10 Enter
The area is 314.159
```


$$\text{Area} = \pi r^2$$

which is expressed in the program as

```
area = PI * pow(radius, 2.0);
```



## Note:

**Program 3-5**  is presented as a demonstration of the `pow` function. In reality, there is no reason to use the `pow` function in such a simple operation. The math statement could just as easily be written as

```
area = PI * radius * radius;
```

The `pow` function is useful, however, in operations that involve larger exponents.



In the

## Spotlight:

### Calculating an Average

Determining the average of a group of values is a simple calculation: You add all of the values, then divide the sum by the number of values. Although this is a straightforward calculation, it is easy to make a mistake when writing a program that calculates an average. For example, let's assume that `a`, `b`, and `c` are `double` variables. Each of the variables holds a value, and we want to calculate the average of those values. If we are careless, we might write a statement such as the following to perform the calculation:

```
average = a + b + c / 3.0;
```

Can you see the error in this statement? When it executes, the division will take place first. The value in `c` will be divided by `3.0`, then the result will be added to the sum of `a + b`. That is not the correct way to calculate an average. To correct this error, we need to put parentheses around `a + b + c`, as shown here:

```
average = (a + b + c) / 3.0;
```

Let's step through the process of writing a program that calculates an average. Suppose you have taken three tests in your computer science class, and you want to write a program that will display the average of the test scores. Here is the algorithm in pseudocode:

*Get the first test score.*

*Get the second test score.*


*Get the third test score.*

*Calculate the average by adding the three test scores and dividing the sum by 3.*

*Display the average.*

In the first three steps, we prompt the user to enter three test scores. Let's say we store those test scores in the `double` variables `test1`, `test2`, and `test3`. Then in the fourth step, we calculate the average of the three test scores. We will use the following statement to perform the calculation and store the result in the `average` variable, which is a `double`:

```
average = (test1 + test2 + test3) / 3.0;
```

The last step is to display the average. [Program 3-6](#)  shows the program.



## Program 3-6

```
1 // This program calculates the average
2 // of three test scores.
3 #include <iostream>
4 #include <cmath>
5 using namespace std;
6
7 int main()
8 {
9     double test1, test2, test3; // To hold
the scores
10    double average;           // To hold the
average
11
12    // Get the three test scores.
13    cout << "Enter the first test score: ";
14    cin >> test1;
15    cout << "Enter the second test score: ";
16    cin >> test2;
17    cout << "Enter the third test score: ";
18    cin >> test3;
19
20    // Calculate the average of the scores.
21    average = (test1 + test2 + test3) / 3.0;
```

```
22
23     // Display the average.
24     cout << "The average score is: " <<
average << endl;
25     return 0;
26 }
```

### Program Output with Example Input Shown in Bold

```
Enter the first test score: 90 Enter
Enter the second test score: 80 Enter
Enter the third test score: 100 Enter
The average score is 90
```



## Checkpoint

3.7 Complete the table below by determining the value of each expression.

3.8 Write C++ expressions for the following algebraic expressions:

$$y = 6x$$

$$a = 2b + 4c$$

$$y = x^2$$

$$g = \frac{x+2}{z^2}$$

$$y = \frac{x^2}{z^2}$$

3.9 Study the following program and complete the table.

```

#include <iostream>
#include <cmath>
using namespace std;
int main()
{
    double value1, value2, value3;

    cout << "Enter a number: ";
    cin >> value1;
    value2 = 2 * pow(value1, 2.0);
    value3 = 3 + value2 / 2 - 1;
    cout << value3 << endl;
    return 0;
}

```

3.10 Complete the following program skeleton so it displays the volume of a cylindrical fuel tank. The formula for the volume of a cylinder is

$$\text{Volume} = \pi r^2 h$$

where

$\pi$  is 3.14159,

$r$  is the radius of the tank, and

$h$  is the height of the tank.

```
#include <iostream>
#include <cmath>
using namespace std;


int main()
{
    double volume, radius, height;
    cout << "This program will tell you the volume of\n";
    cout << "a cylinder-shaped fuel tank.\n";
    cout << "How tall is the tank? ";
    cin >> height;
    cout << "What is the radius of the tank? ";
    cin >> radius;
    // You must complete the program.
}
```

## 3.3 When You Mix Apples and Oranges: Type Conversion

### Concept:

When an operator's operands are of different data types, C++ will automatically convert them to the same data type. This can affect the results of mathematical expressions.

If an `int` is multiplied by a `float`, what data type will the result be? What if a `double` is divided by an `unsigned int`? Is there any way of predicting what will happen in these instances? The answer is yes. C++ follows a set of rules when performing mathematical operations on variables of different data types. It's helpful to understand these rules to prevent subtle errors from creeping into your programs.

Just like officers in the military, data types are ranked. One data type outranks another if it can hold a larger number. For example, a `float` outranks an `int`. [Table 3-7](#)  lists the data types in order of their rank, from highest to lowest.

## Table 3-7 Data Type Ranking

One exception to the ranking in [Table 3-7](#) is when an `int` and a `long` are the same size. In that case, an `unsigned int` outranks `long` because it can hold a higher value.

When C++ is working with an operator, it strives to convert the operands to the same type. This automatic conversion is known as *type coercion*. When a value is converted to a higher data type, it is said to be *promoted*. To *demote* a value means to convert it to a lower data type. Let's look at the specific rules that govern the evaluation of mathematical expressions.

**Rule 1:** `char`s, `short`s, and `unsigned short`s are automatically promoted to `int`.

You will notice that `char`, `short`, and `unsigned short` do not appear in [Table 3-7](#). That's because anytime they are used in a mathematical expression, they are automatically promoted to an `int`. The only exception to this rule is when an `unsigned short` holds a value larger than can be held by an `int`. This can happen on systems where `short`s are the same size as `int`s. In this case, the `unsigned short` is promoted to `unsigned int`.

**Rule 2:** When an operator works with two values of different data types, the lower-ranking value is promoted to the type of the higher-ranking value.

In the following expression, assume that `years` is an `int` and `interestRate` is a `float`:

```
years * interestRate
```

Before the multiplication takes place, `years` will be promoted to a `float`.

**Rule 3:** When the final value of an expression is assigned to a variable, it will be converted to the data type of that variable.

In the following statement, assume that `area` is a `long int`, while `length` and `width` are both `int`s:

```
area = length * width;
```

Since `length` and `width` are both `int`s, they will not be converted to any other data type. The result of the multiplication, however, will be converted to `long` so that it can be stored in `area`.

Watch out for situations where an expression results in a fractional value being assigned to an integer variable. Here is an example:



```
int x, y = 4;  
float z = 2.7;  
x = y * z;
```

In the expression `y * z`, `y` will be promoted to `float` and 10.8 will result from the multiplication. Since `x` is an integer, however, 10.8 will be truncated and 10 will be stored in `x`.

# Integer Division

When you divide an integer by another integer in C++, the result is always an integer. If there is a remainder, it will be discarded. For example, in the following code, `parts` is assigned the value 2.0:

```
double parts;  
parts = 15 / 6;
```

Even though 15 divided by 6 is really 2.5, the .5 part of the result is discarded because we are dividing an integer by an integer. It doesn't matter that `parts` is declared as a `double` because the fractional part of the result is discarded *before* the assignment takes place. In order for a division operation to return a floating-point value, at least one of the operands must be of a floating-point data type. For example, the previous code could be written as:

```
double parts;  
parts = 15.0 / 6;
```

In this code, the literal value 15.0 is interpreted as a floating-point number, so the division operation will return a floating-point number. The value 2.5 will be assigned to `parts`.

## 3.4 Overflow and Underflow


### Concept:

When a variable is assigned a value that is too large or too small in range for that variable's data type, the variable overflows or underflows.

Trouble can arise when a variable is being assigned a value that is too large for its type. Here is a statement where `a`, `b`, and `c` are all short integers:

```
a = b * c;
```

If `b` and `c` are set to large enough values, the multiplication will produce a number too big to be stored in `a`. To prepare for this, `a` should have been defined as an `int`, or a `long int`.

When a variable is assigned a number that is too large for its data type, it *overflows*. Likewise, assigning a value that is too small for a variable causes it to *underflow*. [Program 3-7](#)  shows what

happens when an integer overflows or underflows. (The output shown is from a system with two-byte short integers.)

## Program 3-7

```
1 // This program demonstrates integer overflow
and underflow.
2 #include <iostream>
3 using namespace std;
4
5 int main()
6 {
7     // testVar is initialized with the maximum
value for a short.
8     short testVar = 32767;
9
10    // Display testVar.
11    cout << testVar << endl;
12
13    // Add 1 to testVar to make it overflow.
14    testVar = testVar + 1;
15    cout << testVar << endl;
16
17    // Subtract 1 from testVar to make it
underflow.
18    testVar = testVar - 1;
19    cout << testVar << endl;
```

```
20     return 0;
21 }
```

## Program Output


```
32767
-32768
32767
```

Typically, when an integer overflows, its contents wrap around to that data type's lowest possible value. In [Program 3-7](#), `testVar` wrapped around from 32,767 to -32,768 when 1 was added to it. When 1 was subtracted from `testVar`, it underflowed, which caused its contents to wrap back around to 32,767. No warning or error message is given, so be careful when working with numbers close to the maximum or minimum range of an integer. If an overflow or underflow occurs, the program will use the incorrect number, and therefore produce incorrect results.

When floating-point variables overflow or underflow, the results depend upon how the compiler is configured. Your system may produce programs that do any of the following:

- Produce an incorrect result and continue running.

- Print an error message and immediately stop when either floating-point overflow or underflow occurs.
- Print an error message and immediately stop when floating-point overflow occurs, but store a 0 in the variable when it underflows.
- Give you a choice of behaviors when overflow or underflow occurs.

You can find out how your system reacts by compiling and running **Program 3-8** .

## Program 3-8

```
1 // This program can be used to see how your
system handles
2 // floating-point overflow and underflow.
3 #include <iostream>
4 using namespace std;
5
6 int main()
7 {
8     float test;
9
10    test = 2.0e38 * 1000;    // Should
overflow test.
11    cout << test << endl;
12    test = 2.0e-38 / 2.0e38; // Should
underflow test.
13    cout << test << endl;
14    return 0;
15 }
```



## 3.5 Type Casting

### Concept:

Type casting allows you to perform manual data type conversion.


A *type cast expression* lets you manually promote or demote a value. The general format of a type cast expression is

```
static_cast<DataType>(Value)
```

where `Value` is a variable or literal value that you wish to convert, and `DataType` is the data type to which you wish to convert `Value`. Here is an example of code that uses a type cast expression:

```
double number = 3.7;  
int val;  
val = static_cast<int>(number);
```

This code defines two variables: `number`, a `double`, and `val`, an `int`. The type cast expression in the third statement returns a copy of the value in `number`, converted to an `int`. When a `double` is converted to an `int`, the fractional part is truncated, so this statement stores 3 in `val`. The original value in `number` is not changed, however.

Type cast expressions are useful in situations where C++ will not perform the desired conversion automatically. [Program 3-9](#)  shows an example where a type cast expression is used to prevent integer division from taking place. The statement that uses the type cast expression is

## Program 3-9

```
1 // This program uses a type cast to avoid
integer division.
2 #include <iostream>
3 using namespace std;
4
5 int main()
6 {
7     int books;           // Number of books to
read
8     int months;         // Number of months
spent reading
9     double perMonth;    // Average number of
books per month
10
11     cout << "How many books do you plan to
read? ";
12     cin >> books;
13     cout << "How many months will it take you
to read them? ";
14     cin >> months;
15     perMonth = static_cast<double>(books) /
months;
16     cout << "That is " << perMonth << " books
```

```
per month.\n";  
17     return 0;  
18 }
```

### Program Output with Example Input Shown in Bold


```
How many books do you plan to read? 30  
Enter  
How many months will it take you to read  
them? 7 Enter  
That is 4.28571 books per month.
```

```
perMonth = static_cast<double>(books) / months;
```

The variable `books` is an integer, but its value is converted to a `double` before the division takes place. Without the type cast expression in line 15, integer division would have been performed, resulting in an incorrect answer.



## Warning!

In **Program 3-9** , the following statement would still have resulted in integer division:

```
perMonth = static_cast<double>(books / months);
```

The result of the expression `books / months` is 4. When 4 is converted to a `double`, it is 4.0. To prevent the integer division from taking place, one of the operands should be converted to a `double` prior to the division operation. This forces C++ to automatically convert the value of the other operand to a `double`.

**Program 3-10**  further demonstrates the type cast expression.

## Program 3-10

```
1 // This program uses a type cast expression to
print a character
2 // from a number.
3 #include <iostream>
4 using namespace std;
5
6 int main()
7 {
8     int number = 65;
9
10    // Display the value of the number
variable.
11    cout << number << endl;
12
13    // Display the value of number converted
to
14    // the char data type.
15    cout << static_cast<char>(number) << endl;
16    return 0;
17 }
```

## Program Output

```
65
```

```
A
```

Let's take a closer look at this program. In line 8, the `int` variable `number` is initialized with the value 65. In line 11, `number` is sent to `cout`, causing 65 to be displayed. In line 15, a type cast expression is used to convert the value in `number` to the `char` data type. Recall from [Chapter 2](#) that characters are stored in memory as integer ASCII codes. The number 65 is the ASCII code for the letter 'A', so this statement causes the letter 'A' to be displayed.



### Note:

C++ provides several different type cast expressions. `static_cast` is the most commonly used type cast expression, so we will primarily use it in this book.



3.11 Assume the following variable definitions:

```
int a = 5, b = 12;  
double x = 3.4, z = 9.1;
```

What are the values of the following expressions?

- A. `b / a`
- B. `x * a`
- C. `static_cast<double>(b / a)`
- D. `static_cast<double>(b) / a`
- E. `b / static_cast<double>(a)`
- F. `static_cast<double>(b) / static_cast<double>(a)`
- G. `b / static_cast<int>(x)`
- H. `static_cast<int>(x) * static_cast<int>(z)`
- I. `static_cast<int>(x * z)`
- J. `static_cast<double>(static_cast<int>(x) * static_cast<int>(z))`

3.12 Complete the following program skeleton so it asks the user to enter a character. Store the character in the variable `letter`. Use a type cast expression with the variable in a `cout` statement to display the character's ASCII code on the screen.



```
#include <iostream>
using namespace std;
int main()
{
    char letter;

    // Finish this program
    // as specified above.
    return 0;
}
```

3.13 What will the following program display?

```
#include <iostream>
using namespace std;
int main()
{
    int integer1, integer2;
    double result;
    integer1 = 19;
    integer2 = 2;
    result = integer1 / integer2;
    cout << result << endl;
    result = static_cast<double>(integer1) / integer2;
    cout << result << endl;
    result = static_cast<double>(integer1 / integer2);
    cout << result << endl;
    return 0;
}
```

## 3.6 Multiple Assignment and Combined Assignment

### Concept:

Multiple assignment means to assign the same value to several variables with one statement.

C++ allows you to assign a value to multiple variables at once. If a program has several variables, such as `a`, `b`, `c`, and `d`, and each variable needs to be assigned a value, such as 12, the following statement may be constructed:

```
a = b = c = d = 12;
```

The value 12 will be assigned to each variable listed in the statement.\*

\*The assignment operator works from right to left. 12 is first assigned to `d`, then to `c`, then to `b`, then to `a`.

# Combined Assignment Operators

Quite often, programs have assignment statements of the following form:

```
number = number + 1;
```

The expression on the right side of the assignment operator gives the value of `number` plus 1. The result is then assigned to `number`, replacing the value that was previously stored there. Effectively, this statement adds 1 to `number`. In a similar fashion, the following statement subtracts 5 from `number`.

```
number = number - 5;
```


If you have never seen this type of statement before, it might cause some initial confusion because the same variable name appears on both sides of the assignment operator. [Table 3-8](#) shows other examples of statements written this way.

## Table 3-8 (Assume `x = 6`)

These types of operations are very common in programming. For convenience, C++ offers a special set of operators designed specifically for these jobs. [Table 3-9](#) shows the *combined*

*assignment operators*, also known as *compound operators*, and *arithmetic assignment operators*.

### **Table 3-9 Combined Assignment Operators**

As you can see, the combined assignment operators do not require the programmer to type the variable name twice. Also, they give a clear indication of what is happening in the statement. [Program 3-11](#)  uses combined assignment operators.

## Program 3-11

```
1 // This program tracks the inventory of three
  widget stores
2 // that opened at the same time. Each store
  started with the
3 // same number of widgets in inventory. By
  subtracting the
4 // number of widgets each store has sold from
  its inventory,
5 // the current inventory can be calculated.
6 #include <iostream>
7 using namespace std;
8
9 int main()
10 {
11     int begInv, // Beginning inventory for all
  stores
12         sold, // Number of widgets sold
13         store1, // Store 1's inventory
14         store2, // Store 2's inventory
15         store3; // Store 3's inventory
16
17     // Get the beginning inventory for all the
  stores.
18     cout << "One week ago, 3 new widget stores
```

```
opened\n";  
19     cout << "at the same time with the same  
beginning\n";  
20     cout << "inventory. What was the beginning  
inventory? ";  
21     cin >> begInv;  
22  
23     // Set each store's inventory.  
24     store1 = store2 = store3 = begInv;  
25  
26     // Get the number of widgets sold at store 1.  
27     cout << "How many widgets has store 1 sold? ";  
28     cin >> sold;  
29     store1 -= sold; // Adjust store 1's inventory.  
30  
31     // Get the number of widgets sold at store 2.  
32     cout << "How many widgets has store 2 sold? ";  
33     cin >> sold;  
34     store2 -= sold; // Adjust store 2's inventory.  
35  
36     // Get the number of widgets sold at store 3.  
37     cout << "How many widgets has store 3 sold? ";  
38     cin >> sold;  
39     store3 -= sold; // Adjust store 3's inventory.  
40  
41     // Display each store's current inventory.  
42     cout << "\n\nThe current inventory of each  
store:\n";
```

```
43     cout << "Store 1: " << store1 << endl;
44     cout << "Store 2: " << store2 << endl;
45     cout << "Store 3: " << store3 << endl;
46     return 0;
47 }
```

### Program Output with Example Input Shown in Bold

```
One week ago, 3 new widget stores opened
at the same time with the same beginning
inventory. What was the beginning inventory?
100 Enter
How many widgets has store 1 sold? 25 Enter
How many widgets has store 2 sold? 15 Enter
How many widgets has store 3 sold? 45 Enter
The current inventory of each store:
Store 1: 75
Store 2: 85
Store 3: 55
```

More elaborate statements may be expressed with the combined assignment operators. Here is an example:




```
result *= a + 5;
```

In this statement, `result` is multiplied by the sum of `a + 5`. When constructing such statements, you must realize the precedence of the combined assignment operators is lower than that of the regular math operators. The statement above is equivalent to

```
result = result * (a + 5);
```

which is different from

```
result = result * a + 5;
```

**Table 3-10**  shows other examples of such statements and their assignment statement equivalencies.

### **Table 3-10 Example Usage of the Combined Assignment Operators**



## Checkpoint

3.14 Write a multiple assignment statement that assigns 0 to the variables `total`, `subtotal`, `tax`, and `shipping`.

3.15 Write statements using combined assignment operators to perform the following:

- A. Add 6 to `x`.
- B. Subtract 4 from `amount`.
- C. Multiply `y` by 4.
- D. Divide `total` by 27.
- E. Store in `x` the remainder of `x` divided by 7.
- F. Add `y * 5` to `x`.
- G. Subtract `discount` times 4 from `total`.
- H. Multiply `increase` by `salesRep` times 5.
- I. Divide `profit` by `shares` minus 1000.

3.16 What will the following program display?

```
#include <iostream>
using namespace std;
int main()
{
    int unus, duo, tres;

    unus = duo = tres = 5;
    unus += 4;
    duo *= 2;
    tres -= 4;
    unus /= 3;
    duo += tres;
    cout << unus << endl;
    cout << duo << endl;
    cout << tres << endl;
    return 0;
}
```

## 3.7 Formatting Output

### Concept:

The `cout` object provides ways to format data as it is being displayed. This affects the way data appears on the screen.

The same data can be printed or displayed in several different ways. For example, all of the following numbers have the same value, although they look different:

```
720
720.0
720.00000000
7.2e+2
+720.0
```

The way a value is printed is called its *formatting*. The `cout` object has a standard way of formatting variables of each data type. Sometimes, however, you need more control over the way data is

displayed. Consider [Program 3-12](#), for example, which displays three rows of numbers with a space between each one.

## Program 3-12

```
1 // This program displays three rows of
numbers.
2 #include <iostream>
3 using namespace std;
4
5 int main()
6 {
7     int num1 = 2897, num2 = 5,    num3 = 837,
8         num4 = 34,    num5 = 7,    num6 = 1623,
9         num7 = 390,    num8 = 3456, num9 = 12;
10
11     // Display the first row of numbers
12     cout << num1 << " " << num2 << " " << num3
<< endl;
13
14     // Display the second row of numbers
15     cout << num4 << " " << num5 << " " << num6
<< endl;
16
17     // Display the third row of numbers
18     cout << num7 << " " << num8 << " " << num9
<< endl;
```

```
19     return 0;
20 }
```

## Program Output

```
2897 5 837
34 7 1623
390 3456 12
```

Unfortunately, the numbers do not line up in columns. This is because some of the numbers, such as 5 and 7, occupy one position on the screen, while others occupy two or three positions. `cout` uses just the number of spaces needed to print each number.

To remedy this, `cout` offers a way of specifying the minimum number of spaces to use for each number. A stream manipulator, `setw`, can be used to establish print fields of a specified width. Here is an example of how it is used:

```
value = 23;
cout << setw(5) << value;
```



The number inside the parentheses after the word `setw` specifies the *field width* for the value immediately following it. The field width is the minimum number of character positions, or spaces, on the screen to print the value in. In the example above, the number 23 will be displayed in a field of 5 spaces. Since 23 only occupies 2 positions on the screen, 3 blank spaces will be printed before it. To further clarify how this works, look at the following statements:

```
value = 23;
cout << "(" << setw(5) << value << ")";
```

This will cause the following output:

```
( 23)
```

Notice the number occupies the last two positions in the field. Since the number did not use the entire field, `cout` filled the extra 3 positions with blank spaces. Because the number appears on the right side of the field with blank spaces “padding” it in front, it is said to be *right-justified*.

**Program 3-13**  shows how the numbers in **Program 3-12**  can be printed in columns that line up perfectly by using `setw`.



## Program 3-13

```
1 // This program displays three rows of
numbers.
2 #include <iostream>
3 #include <iomanip> // Required for setw
4 using namespace std;
5
6 int main()
7 {
8     int num1 = 2897, num2 = 5,    num3 = 837,
9     num4 = 34,    num5 = 7,    num6 = 1623,
10    num7 = 390,    num8 = 3456,    num9 = 12;
11
12    // Display the first row of numbers
13    cout << setw(6) << num1 << setw(6)
14    << num2 << setw(6) << num3 << endl;
15
16    // Display the second row of numbers
17    cout << setw(6) << num4 << setw(6)
18    << num5 << setw(6) << num6 << endl;
19
20    // Display the third row of numbers
21    cout << setw(6) << num7 << setw(6)
22    << num8 << setw(6) << num9 << endl;
```

```
23     return 0;
24 }
```

## Program Output

```
2897     5     837
      34     7   1623
    390  3456    12
```

By printing each number in a field of 6 positions, they are displayed in perfect columns.



### Note:

A new header file, `<iomanip>`, is included in **Program 3-13**. It must be used in any program that uses `setw`.

Notice how a `setw` manipulator is used with each value, because `setw` only establishes a field width for the value immediately

following it. After that value is printed, `cout` goes back to its default method of printing.

You might wonder what will happen if the number is too large to fit in the field, as in the following statement:

```
value = 18397;  
cout << setw(2) << value;
```

In cases like this, `cout` will print the entire number. `setw` only specifies the minimum number of positions in the print field. Any number larger than the minimum will cause `cout` to override the `setw` value.

You may specify the field width of any type of data. [Program 3-14](#) shows `setw` being used with an integer, a floating-point number, and a `string` object.

## Program 3-14

```
1 // This program demonstrates the setw
manipulator being
2 // used with values of various data types.
3 #include <iostream>
4 #include <iomanip>
5 #include <string>
6 using namespace std;
7
8 int main()
9 {
10     int intValue = 3928;
11     double doubleValue = 91.5;
12     string stringValue = "John J. Smith";
13
14     cout << "(" << setw(5) << intValue << ")"
<< endl;
15     cout << "(" << setw(8) << doubleValue <<
")" << endl;
16     cout << "(" << setw(16) << stringValue <<
")" << endl;
17     return 0;
18 }
```

## Program Output

```
( 3928)
(    91.5)
(    John J. Smith)
```

**Program 3-14**  can be used to illustrate the following points:

- The field width of a floating-point number includes a position for the decimal point.
- The field width of a `string` object includes all characters in the string, including spaces.
- The values printed in the field are right-justified by default. This means they are aligned with the right side of the print field, and any blanks that must be used to pad it are inserted in front of the value.

# The `setprecision` Manipulator

Floating-point values may be rounded to a number of *significant digits*, or *precision*, which is the total number of digits that appear before and after the decimal point. You can control the number of significant digits with which floating-point values are displayed by using the `setprecision` manipulator. [Program 3-15](#) shows the results of a division operation displayed with different numbers of significant digits.



**Formatting Numbers with** `setprecision`

## Program 3-15

```
1 // This program demonstrates how setprecision
rounds a
2 // floating-point value.
3 #include <iostream>
4 #include <iomanip>
5 using namespace std;
6
7 int main()
8 {
9     double quotient, number1 = 132.364,
number2 = 26.91;
10
11     quotient = number1 / number2;
12     cout << quotient << endl;
13     cout << setprecision(5) << quotient <<
endl;
14     cout << setprecision(4) << quotient <<
endl;
15     cout << setprecision(3) << quotient <<
endl;
16     cout << setprecision(2) << quotient <<
endl;
17     cout << setprecision(1) << quotient <<
```

```
endl;  
18     return 0;  
19 }
```

## Program Output

```
4.91877  
4.9188  
4.919  
4.92  
4.9  
5
```

The first value is displayed in line 12 without the `setprecision` manipulator. (By default, the system in the illustration displays floating-point values with 6 significant digits.) The subsequent `cout` statements print the same value, but rounded to 5, 4, 3, 2, and 1 significant digits.

If the value of a number is expressed in fewer digits of precision than specified by `setprecision`, the manipulator will have no effect. In the following statements, the value of `dollars` only has four digits of precision, so the number printed by both `cout` statements is 24.51.




```
double dollars = 24.51;
cout << dollars << endl;           // Displays
24.51
cout << setprecision(5) << dollars << endl;   // Displays
24.51
```

**Table 3-11**  shows how `setprecision` affects the way various values are displayed.

### Table 3-11 The `setprecision` Manipulator

Unlike field width, the precision setting remains in effect until it is changed to some other value. As with all formatting manipulators, you must include the header file `<iomanip>` to use `setprecision`.

**Program 3-16**  shows how the `setw` and `setprecision` manipulators may be combined to fully control the way floating-point numbers are displayed.

## Program 3-16

```
1 // This program asks for sales amounts for 3
days. The total
2 // sales are calculated and displayed in a
table.
3 #include <iostream>
4 #include <iomanip>
5 using namespace std;
6
7 int main()
8 {
9     double day1, day2, day3, total;
10
11     // Get the sales for each day.
12     cout << "Enter the sales for day 1: ";
13     cin >> day1;
14     cout << "Enter the sales for day 2: ";
15     cin >> day2;
16     cout << "Enter the sales for day 3: ";
17     cin >> day3;
18
19     // Calculate the total sales.
20     total = day1 + day2 + day3;
21
```

```
22     // Display the sales amounts.
23     cout << "\nSales Amounts\n";
24     cout << "-----\n";
25     cout << setprecision(5);
26     cout << "Day 1: " << setw(8) << day1 <<
endl;
27     cout << "Day 2: " << setw(8) << day2 <<
endl;
28     cout << "Day 3: " << setw(8) << day3 <<
endl;
29     cout << "Total: " << setw(8) << total <<
endl;
30     return 0;
31 }
```

**Program Output with Example Input Shown in Bold**

```
Enter the sales for day 1: 321.57 Enter
Enter the sales for day 2: 269.62 Enter
Enter the sales for day 3: 307.77 Enter
```

Sales Amounts

```
-----
Day 1: 321.57
Day 2: 269.62
Day 3: 307.77
Total: 898.96
```

# The `fixed` Manipulator


The `setprecision` manipulator can sometimes surprise you in an undesirable way. When the precision of a number is set to a lower value, numbers tend to be printed in scientific notation. For example, here is the output of [Program 3-16](#) with larger numbers being input:

## Program 3-16

### Program Output with Example Input Shown in Bold

```
Enter the sales for day 1: 145678.99 Enter
Enter the sales for day 2: 205614.85 Enter
Enter the sales for day 3: 198645.22 Enter

Sales Amounts
-----
Day 1: 1.4568e+005
Day 2: 2.0561e+005
Day 3: 1.9865e+005
Total: 5.4994e+005
```

Another stream manipulator, `fixed`, forces `cout` to print the digits in *fixed-point notation*, or decimal. [Program 3-17](#)  shows how the `fixed` manipulator is used.

## Program 3-17

```
1 // This program asks for sales amounts for 3
days. The total
2 // sales are calculated and displayed in a
table.
3 #include <iostream>
4 #include <iomanip>
5 using namespace std;
6
7 int main()
8 {
9     double day1, day2, day3, total;
10
11     // Get the sales for each day.
12     cout << "Enter the sales for day 1: ";
13     cin >> day1;
14     cout << "Enter the sales for day 2: ";
15     cin >> day2;
16     cout << "Enter the sales for day 3: ";
17     cin >> day3;
18
19     // Calculate the total sales.
20     total = day1 + day2 + day3;
21
```

```
22     // Display the sales amounts.
23     cout << "\nSales Amounts\n";
24     cout << "-----\n";
25     cout << setprecision(2) << fixed;
26     cout << "Day 1: " << setw(8) << day1 <<
endl;
27     cout << "Day 2: " << setw(8) << day2 <<
endl;
28     cout << "Day 3: " << setw(8) << day3 <<
endl;
29     cout << "Total: " << setw(8) << total <<
endl;
30     return 0;
31 }
```

**Program Output with Example Input Shown in Bold**



```
Enter the sales for day 1: 1321.87 Enter
Enter the sales for day 2: 1869.26 Enter
Enter the sales for day 3: 1403.77 Enter
```

```
Sales Amounts
```

```
-----
```

```
Day 1:      1321.87
```

```
Day 2:      1869.26
```

```
Day 3:      1403.77
```

```
Total:     4594.90
```

The statement in line 25 uses the `fixed` manipulator:

```
cout << setprecision(2) << fixed;
```

When the `fixed` manipulator is used, all floating-point numbers that are subsequently printed will be displayed in fixed-point notation, with the number of digits to the right of the decimal point specified by the `setprecision` manipulator.

When the `fixed` and `setprecision` manipulators are used together, the value specified by the `setprecision` manipulator will be the

number of digits to appear after the decimal point, not the number of significant digits. For example, look at the following code:

```
double x = 123.4567;  
cout << setprecision(2) << fixed << x << endl;
```

Because the `fixed` manipulator is used, the `setprecision` manipulator will cause the number to be displayed with two digits after the decimal point. The value will be displayed as 123.46.

# The `showpoint` Manipulator

By default, floating-point numbers are not displayed with trailing zeros, and floating-point numbers that do not have a fractional part are not displayed with a decimal point. For example, look at the following code:

```
double x = 123.4, y = 456.0;
cout << setprecision(6) << x << endl;
cout << y << endl;
```

The `cout` statements will produce the following output:

```
123.4
456
```

Although six significant digits are specified for both numbers, neither number is displayed with trailing zeros. If we want the numbers padded with trailing zeros, we must use the `showpoint` manipulator as shown in the following code:

```
double x = 123.4, y = 456.0;
cout << setprecision(6) << showpoint << x << endl;
cout << y << endl;
```

These `cout` statements will produce the following output:

```
123.400
456.000
```



### **Note:**

With most compilers, trailing zeros are displayed when the `setprecision` and `fixed` manipulators are used together.

# The `left` and `right` Manipulators

Normally output is right-justified. For example, look at the following code:

```
double x = 146.789, y = 24.2, z = 1.783;
cout << setw(10) << x << endl;
cout << setw(10) << y << endl;
cout << setw(10) << z << endl;
```

Each of the variables, `x`, `y`, and `z`, is displayed in a print field of 10 spaces. The output of the `cout` statements is

```
146.789
 24.2
 1.783
```

Notice each value is right-justified, or aligned to the right of its print field. You can cause the values to be left-justified by using the `left` manipulator, as shown in the following code.

```
double x = 146.789, y = 24.2, z = 1.783;  
cout << left << setw(10) << x << endl;  
cout << setw(10) << y << endl;  
cout << setw(10) << z << endl;
```

The output of these `cout` statements is

```
146.789  
24.2  
1.783
```

In this case, the numbers are aligned to the left of their print fields. The `left` manipulator remains in effect until you use the `right` manipulator, which causes all subsequent output to be right-justified.

**Table 3-12** [📄](#) summarizes the manipulators we have discussed.

### Table 3-12 Stream Manipulators



## Checkpoint

3.17 Write `cout` statements with stream manipulators that perform the following:

- A. Display the number 34.789 in a field of nine spaces with two decimal places of precision.
- B. Display the number 7.0 in a field of five spaces with three decimal places of precision.  
The decimal point and any trailing zeros should be displayed.
- C. Display the number  $5.789e^{+12}$  in fixed-point notation.
- D. Display the number 67 left-justified in a field of seven spaces.

3.18 The following program will not compile because the lines have been mixed up:

```

#include <iomanip>
}
cout << person << endl;
string person = "Wolfgang Smith";
int main()
cout << person << endl;
{
#include <iostream>
return 0;
cout << left;
using namespace std;
cout << setw(20);
cout << right;

```

When the lines are properly arranged, the program should display the following:

```

Wolfgang Smith
Wolfgang Smith

```

Rearrange the lines in the correct order. Test the program by entering it on the computer, compiling it, and running it.

3.19 The following program skeleton asks for an angle in degrees and converts it to radians. The formatting of the final output is left to you.




```
#include <iostream>
#include <iomanip>
using namespace std;
int main()
{
    const double PI = 3.14159;
    double degrees, radians;

    cout << "Enter an angle in degrees and I will convert
it\n";
    cout << "to radians for you: ";
    cin >> degrees;
    radians = degrees * PI / 180;
    // Display the value in radians left-justified, in
fixed
    // point notation, with 4 places of precision, in a
field
    // 5 spaces wide, making sure the decimal point is
always
    // displayed.
    return 0;
}
```

## 3.8 Working with Characters and `string` Objects

### Concept:

Special functions exist for working with characters and `string` objects.

Although it is possible to use `cin` with the `>>` operator to input strings, it can cause problems of which you need to be aware. When `cin` reads input, it passes over and ignores any leading *whitespace* characters (spaces, tabs, or line breaks). Once it comes to the first nonblank character and starts reading, it stops reading when it gets to the next whitespace character. [Program 3-18](#)  illustrates this problem.

## Program 3-18

```
1 // This program illustrates a problem that can occur if
2 // cin is used to read character data into a string object.
3 #include <iostream>
4 #include <string>
5 using namespace std;
6
7 int main()
8 {
9     string name;
10    string city;
11
12    cout << "Please enter your name: ";
13    cin >> name;
14    cout << "Enter the city you live in: ";
15    cin >> city;
16
17    cout << "Hello, " << name << endl;
18    cout << "You live in " << city << endl;
19    return 0;
20 }
```

### Program Output with Example Input Shown in Bold

```
Please enter your name: Kate Smith Enter
Enter the city you live in: Hello, Kate
You live in Smith
```

Notice the user was never given the opportunity to enter the city. In the first input statement, when `cin` came to the space between `Kate` and `Smith`, it stopped reading, storing just `Kate` as the value of `name`. In the second input statement, `cin` used the leftover characters it found in the keyboard buffer and stored `Smith` as the value of `city`.

To work around this problem, you can use a C++ function named `getline`. The `getline` function reads an entire line, including leading and embedded spaces, and stores it in a `string` object. The `getline` function looks like the following, where `cin` is the input stream we are reading from and `inputLine` is the name of the `string` object receiving the input:

```
getline(cin, inputLine);
```

**Program 3-19**  illustrates using the `getline` function.

## Program 3-19

```
1 // This program demonstrates using the getline function
2 // to read character data into a string object.
3 #include <iostream>
4 #include <string>
5 using namespace std;
6
7 int main()
8 {
9     string name;
10    string city;
11
12    cout << "Please enter your name: ";
13    getline(cin, name);
14    cout << "Enter the city you live in: ";
15    getline(cin, city);
16
17    cout << "Hello, " << name << endl;
18    cout << "You live in " << city << endl;
19    return 0;
20 }
```

### Program Output with Example Input Shown in Bold

```
Please enter your name: Kate Smith Enter
Enter the city you live in: Raleigh Enter
Hello, Kate Smith
You live in Raleigh
```

# Inputting a Character

Sometimes you want to read only a single character of input. For example, some programs display a menu of items for the user to choose from. Often the selections are denoted by the letters A, B, C, and so forth. The user chooses an item from the menu by typing a character. The simplest way to read a single character is with `cin` and the `>>` operator, as illustrated in [Program 3-20](#).

## Program 3-20

```
1 // This program reads a single character into a char variable.
2 #include <iostream>
3 using namespace std;
4
5 int main()
6 {
7     char ch;
8
9     cout << "Type a character and press Enter: ";
10    cin >> ch;
11    cout << "You entered " << ch << endl;
12    return 0;
13 }
```

## Program Output with Example Input Shown in Bold

```
Type a character and press Enter: A Enter
You entered A
```

## Using `cin.get`

As with string input, however, there are times when using `cin >>` to read a character does not do what you want. For example, because it passes over all leading whitespace, it is impossible to input just a blank or `Enter` with `cin >>`. The program will not continue past the `cin` statement until some character other than the spacebar, tab key, or `Enter` key has been pressed. (Once such a character is entered, the `Enter` key must still be pressed before the program can continue to the next statement.) Thus, programs that ask the user to `"Press the Enter key to continue."` cannot use the `>>` operator to read only the pressing of the `Enter` key.

In those situations, the `cin` object has a built-in function named `get` that is helpful. Because the `get` function is built into the `cin` object, we say that it is a *member function* of `cin`. The `get` member function reads a single character, including any whitespace character. If the program needs to store the character being read, the `get` member function can be called in either of the following ways. In both examples, assume `ch` is the name of a `char` variable into which the character is being read.

```
cin.get(ch);  
ch = cin.get();
```

If the program is using the `cin.get` function simply to pause the screen until the key is pressed and does not need to store the character, the function can also be called like this:

```
cin.get();
```

**Program 3-21**  illustrates all three ways to use the `cin.get` function.

## Program 3-21

```
1 // This program demonstrates three ways
2 // to use cin.get() to pause a program.
3 #include <iostream>
4 using namespace std;
5
6 int main()
7 {
8     char ch;
9
10    cout << "This program has paused. Press Enter to continue.";
11    cin.get(ch);
12    cout << "It has paused a second time. Please press Enter again.";
13    ch = cin.get();
14    cout << "It has paused a third time. Please press Enter again.";
15    cin.get();
16    cout << "Thank you!";
17    return 0;
18 }
```

### Program Output with Example Input Shown in Bold

```
This program has paused. Press Enter to continue. Enter
It has paused a second time. Please press Enter again. Enter
It has paused a third time. Please press Enter again. Enter
Thank you!
```



## Mixing `cin >>` and `cin.get`

Mixing `cin >>` with `cin.get` can cause an annoying and hard-to-find problem. For example, look at [Program 3-22](#).

### Program 3-22

```
1 // This program demonstrates a problem that occurs
2 // when you mix cin >> with cin.get().
3 #include <iostream>
4 using namespace std;
5
6 int main()
7 {
8     char ch;           // Define a character variable
9     int number;       // Define an integer variable
10
11     cout << "Enter a number: ";
12     cin >> number;    // Read an integer
13     cout << "Enter a character: ";
14     ch = cin.get();  // Read a character
15     cout << "Thank You!\n";
16     return 0;
17 }
```

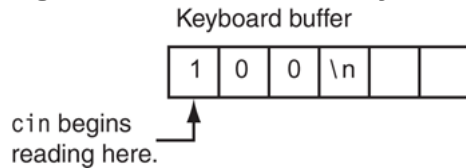
### Program Output with Example Input Shown in Bold

```
Enter a number: 100 Enter
Enter a character: Thank You!
```

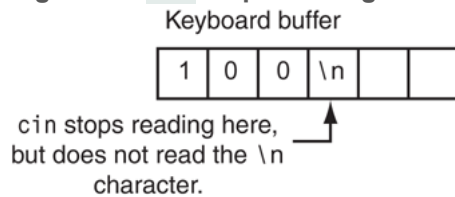
When this program runs, line 12 lets the user enter a number, but it appears as though the statement in line 14 is skipped. This happens because `cin >>` and `cin.get` use slightly different techniques for reading data.

In the example run of the program, when line 12 executed, the user entered 100 and pressed the key. Pressing the key causes a newline character (`'\n'`) to be stored in the keyboard buffer, as shown in [Figure 3-5](#). The `cin >>` statement in line 12 begins reading the data that the user entered, and stops reading when it comes to the newline character. This is shown in [Figure 3-6](#). The newline character is not read, but remains in the keyboard buffer.

**Figure 3-5 Contents of the keyboard buffer**



**Figure 3-6 cin stops reading at the newline character**



When the `cin.get` function in line 14 executes, it begins reading the keyboard buffer where the previous input operation stopped. That means `cin.get` reads the newline character, without giving the user a chance to enter any more input. You can remedy this situation by using the `cin.ignore` function, described in the following section.

## Using `cin.ignore`

To solve the problem previously described, you can use another of the `cin` object's member functions named `ignore`. The `cin.ignore` function tells the `cin` object to skip one or more characters in the keyboard buffer. Here is its general form:



```
cin.ignore(n, c);
```

The arguments shown in the parentheses are optional. If used, *n* is an integer and *c* is a character. They tell `cin` to skip *n* number of characters, or until the character *c* is encountered. For example, the following statement causes `cin` to skip the next 20 characters or until a newline is encountered, whichever comes first:

```
cin.ignore(20, '\n');
```

If no arguments are used, `cin` will skip only the very next character. Here's an example:

```
cin.ignore();
```

**Program 3-23** , which is a modified version of **Program 3-22** , demonstrates the function. Notice a call to `cin.ignore` has been inserted in line 13, right after the `cin >>` statement.

## Program 3-23

```
1 // This program successfully uses both
2 // cin >> and cin.get() for keyboard input.
3 #include <iostream>
4 using namespace std;
5
6 int main()
7 {
8     char ch;
9     int number;
10
11     cout << "Enter a number: ";
12     cin >> number;
13     cin.ignore(); // Skip the newline character
14     cout << "Enter a character: ";
15     ch = cin.get();
16     cout << "Thank You!\n";
17     return 0;
18 }
```

### Program Output with Example Input Shown in Bold

```
Enter a number: 100 Enter
Enter a character: Z Enter
Thank You!
```

## string Member Functions and Operators

C++ `string` objects also have a number of member functions. For example, if you want to know the length of the string that is stored in a `string` object, you can call the object's `length` member function. Here is an example of how to use it:

```
string state = "Texas";
int size = state.length();
```

The first statement creates a `string` object named `state` and initializes it with the string `"Texas"`. The second statement defines an `int` variable named `size` and initializes it with the length of the string in the `state` object. After this code executes, the `size` variable will hold the value 5.

Certain operators also work with `string` objects. One of them is the `+` operator. You have already encountered the `+` operator to add two numeric quantities. Because strings cannot be added, when this operator is used with string operands it *concatenates* them, or joins them together. Assume we have the following definitions and initializations in a program:

```
string greeting1 = "Hello ";
string greeting2;
string name1 = "World";
string name2 = "People";
```


The following statements illustrate how string concatenation works:

```
greeting2 = greeting1 + name1; // greeting2 now holds "Hello World"
greeting1 = greeting1 + name2; // greeting1 now holds "Hello People"
```

Notice the string stored in `greeting1` has a blank as its last character. If the blank were not there, `greeting2` would have been assigned the string `"HelloWorld"`.

The last statement in the previous example could also have been written using the `+=` combined assignment operator, to achieve the same result:

```
greeting1 += name2;
```

You will learn about other useful `string` member functions and operators in [Chapter 10](#) .

## 3.9 More Mathematical Library Functions

### Concept:

The C++ runtime library provides several functions for performing complex mathematical operations.

Earlier in this chapter, you learned to use the `pow` function to raise a number to a power. The C++ library has numerous other functions that perform specialized mathematical operations. These functions are useful in scientific and special-purpose programs. [Table 3-13](#) shows several of these, each of which requires the `<cmath>` header file.


### Table 3-13 `<cmath>` Library Functions

Each of these functions is as simple to use as the `pow` function. The following program segment demonstrates the `sqrt` function, which returns the square root of a number:

```
cout << "Enter a number: ";  
cin >> num;  
s = sqrt(num);  
cout << "The square root of " << num << " is " << s << endl;
```

Here is the output of the program segment, with 25 as the number entered by the user:

```
Enter a number: 25  
The square root of 25 is 5
```

**Program 3-24**  shows the `sqrt` function being used to find the hypotenuse of a right triangle. The program uses the following formula, taken from the Pythagorean theorem:



## Program 3-24

```
1 // This program asks for the lengths of the
two sides of a
2 // right triangle. The length of the
hypotenuse is then
3 // calculated and displayed.
4 #include <iostream>
5 #include <iomanip> // For setprecision
6 #include <cmath> // For the sqrt and pow
functions
7 using namespace std;
8
9 int main()
10 {
11     double a, b, c;
12
13     cout << "Enter the length of side a: ";
14     cin >> a;
15     cout << "Enter the length of side b: ";
16     cin >> b;
17     c = sqrt(pow(a, 2.0) + pow(b, 2.0));
18     cout << "The length of the hypotenuse is
";
19     cout << setprecision(2) << c << endl;
```

```
20     return 0;
21 }
```

### Program Output with Example Input Shown in Bold

```
Enter the length of side a: 5.0 Enter
Enter the length of side b: 12.0 Enter
The length of the hypotenuse is 13
```

$$c = \sqrt{a^2 + b^2}$$

In the formula,  $c$  is the length of the hypotenuse, and  $a$  and  $b$  are the lengths of the other sides of the triangle.

The following statement, taken from [Program 3-24](#), calculates the square root of the sum of the squares of the triangle's two sides:

```
c = sqrt(pow(a, 2.0) + pow(b, 2.0));
```

Notice the following mathematical expression is used as the `sqrt` function's argument:

```
pow(a, 2.0) + pow(b, 2.0)
```

This expression calls the `pow` function twice: once to calculate the square of `a`, and again to calculate the square of `b`. These two squares are then added together, and the sum is sent to the `sqrt` function.

# Random Numbers

Random numbers are useful for lots of different programming tasks. The following are just a few examples:

- Random numbers are commonly used in games. For example, computer games that let the player roll dice use random numbers to represent the values of the dice.
- Programs that show cards being drawn from a shuffled deck use random numbers to represent the face values of the cards.
- Random numbers are useful in simulation programs. In some simulations, the computer must randomly decide how a person, animal, insect, or other living being will behave. Formulas can be constructed in which a random number is used to determine various actions and events that take place in the program.
- Random numbers are useful in statistical programs that must randomly select data for analysis.
- Random numbers are commonly used in computer security to encrypt sensitive data.

The C++ library has a function, `rand()`, that you can use to generate random numbers. (The `rand()` function requires the `<cstdlib>` header file.) The number returned from the function is an `int`. Here is an example of its usage:


```
y = rand();
```

After this statement executes, the variable `y` will contain a random number. In actuality, the numbers produced by `rand()` are pseudorandom. The function uses an algorithm that produces the same sequence of numbers each time the program is repeated on the same system. For example, suppose the following statements are executed:

```
cout << rand() << endl;  
cout << rand() << endl;  
cout << rand() << endl;
```

The three numbers displayed will appear to be random, but each time the program runs, the same three values will be generated. In order to randomize the results of `rand()`, the `srand()` function must be used. `srand()` accepts an `unsigned int` argument, which acts as a seed value for the algorithm. By specifying different seed values, `rand()` will generate different sequences of random numbers.

A common practice for getting unique seed values is to call the `time` function, which is part of the standard library. The `time` function returns the number of seconds that have elapsed since midnight,

January 1, 1970. The `time` function requires the `<ctime>` header file, and you pass 0 as an argument to the function. **Program 3-25**  demonstrates this. The program should generate three different random numbers each time it is executed.

## Program 3-25

```
1 // This program demonstrates random numbers.
2 #include <iostream>
3 #include <cstdlib> // For rand and srand
4 #include <ctime> // For the time function
5 using namespace std;
6
7 int main()
8 {
9     // Get the system time.
10    unsigned seed = time(0);
11
12    // Seed the random number generator.
13    srand(seed);
14
15    // Display three random numbers.
16    cout << rand() << endl;
17    cout << rand() << endl;
18    cout << rand() << endl;
19    return 0;
20 }
```

## Program Output

```
23861
20884
21941
```

If you wish to limit the range of the random number, use the following formula:

```
y = (rand() % (maxValue - minValue + 1)) + minValue;
```

In the formula, *minValue* is the lowest number in the range, and *maxValue* is the highest number in the range. For example, the following code assigns a random number in the range of 1 through 100 to the variable `y`:

```
const int MIN_VALUE = 1;
const int MAX_VALUE = 100;
y = (rand() % (MAX_VALUE - MIN_VALUE + 1)) + MIN_VALUE;
```

As another example, the following code assigns a random number in the range of 100 through 200 to the variable `y`:



```
const int MIN_VALUE = 100;  
const int MAX_VALUE = 200;  
y = (rand() % (MAX_VALUE - MIN_VALUE + 1)) + MIN_VALUE;
```


The following *In the Spotlight* section demonstrates how to use random numbers to simulate rolling dice.



In the

## Spotlight:

### Using Random Numbers

Dr. Kimura teaches an introductory statistics class and has asked you to write a program that he can use in class to simulate the rolling of dice. The program should randomly generate two numbers in the range of 1 through 6 and display them. **Program 3-26**  shows the program, with three examples of program output.

## Program 3-26

```
1 // This program simulates rolling dice.
2 #include <iostream>
3 #include <cstdlib> // For rand and
  srand
4 #include <ctime> // For the time
  function
5 using namespace std;
6
7 int main()
8 {
9     // Constants
10    const int MIN_VALUE = 1; //
  Minimum die value
11    const int MAX_VALUE = 6; //
  Maximum die value
12
13    // Variables
14    int die1; // To hold the value of
  die #1
15    int die2; // To hold the value of
  die #2
16
```

```
17 // Get the system time.
18 unsigned seed = time(0);
19
20 // Seed the random number
generator.
21 srand(seed);
22
23 cout << "Rolling the dice...\n";
24 die1 = (rand() % (MAX_VALUE -
MIN_VALUE + 1)) + MIN_VALUE;
25 die2 = (rand() % (MAX_VALUE -
MIN_VALUE + 1)) + MIN_VALUE;
26 cout << die1 << endl;
27 cout << die2 << endl;
28 return 0;
29 }
```

## Program Output

```
Rolling the dice...
5
2
```

## Program Output

```
Rolling the dice...
```

```
4
```

```
6
```

## Program Output

```
Rolling the dice...
```

```
3
```

```
1
```



## Checkpoint

3.20 Write a short description of each of the following functions:

```
cos    log    sin
exp    log10  sqrt
fmod   pow    tan
```

3.21 Assume the variables `angle1` and `angle2` hold angles stored in radians. Write a statement that adds the sine of `angle1` to the cosine of `angle2` and stores the result in the variable `x`.

3.22 To find the cube root (the third root) of a number, raise it to the power of  $\frac{1}{3}$ . To find the fourth root of a number, raise it to the power of  $\frac{1}{4}$ . Write a statement that will find the fifth root of the variable `x` and store the result in the variable `y`.

3.23 The cosecant of the angle  $a$  is

$$\frac{1}{\sin a}$$

Write a statement that calculates the cosecant of the angle stored in the variable `a`, and stores it in the variable `y`.

## 3.10 Focus on Debugging: Hand Tracing a Program

*Hand tracing* is a debugging process where you pretend that you are the computer executing a program. You step through each of the program's statements one by one. As you look at a statement, you record the contents that each variable will have after the statement executes. This process is often helpful in finding mathematical mistakes and other logic errors.

To hand trace a program, you construct a chart with a column for each variable. The rows in the chart correspond to the lines in the program. For example, [Program 3-27](#) is shown with a hand trace chart. The program uses the following four variables: `num1`, `num2`, `num3`, and `avg`. Notice the hand trace chart has a column for each variable, and a row for each line of code in function `main`.

## Program 3-27

```
1 // This program asks for three numbers, then
2 // displays the average of the numbers.
3 #include <iostream>
4 using namespace std;

5 int main()
6 {
7     double num1, num2, num3, avg;
8     cout << "Enter the first number: ";
9     cin >> num1;
10    cout << "Enter the second number: ";
11    cin >> num2;
12    cout << "Enter the third number: ";
13    cin >> num3;
14    avg = num1 + num2 + num3 / 3;
15    cout << "The average is " << avg << endl;
16    return 0;
17 }
```



This program, which asks the user to enter three numbers and then displays the average of the numbers, has a bug. It does not display the correct average. The output of a sample session with the program follows.

### Program Output with Example Input Shown in Bold

```
Enter the first number: 10 Enter
Enter the second number: 20 Enter
Enter the third number: 30 Enter
The average is 40
```

The correct average of 10, 20, and 30 is 20, not 40. To find the error, we will hand trace the program. To hand trace this program, you step through each statement, observing the operation that is taking place, then record the contents of the variables after the statement executes. After the hand trace is complete, the chart will appear as follows. We have written question marks in the chart where we do not know the contents of a variable.

## Program 3-27 (with hand trace chart filled)

```
1 // This program asks for three numbers, then
2 // displays the average of the numbers.
3 #include <iostream>
4 using namespace std;
5 int main()
6 {
7     double num1, num2, num3, avg;
8     cout << "Enter the first number: ";
9     cin >> num1;
10    cout << "Enter the second number: ";
11    cin >> num2;
12    cout << "Enter the third number: ";
13    cin >> num3;
14    avg = num1 + num2 + num3 / 3;
15    cout << "The average is " << avg << endl;
16    return 0;
17 }
```

Do you see the error? By examining the statement that performs the math operation in line 14, we find a mistake. The division operation takes place before the addition operations, so we must rewrite that statement as


```
avg = (num1 + num2 + num3) / 3;
```

Hand tracing is a simple process that focuses your attention on each statement in a program. Often this helps you locate errors that are not obvious.

## 3.11 Focus on Problem Solving: A Case Study

General Crates, Inc. builds custom-designed wooden crates. With materials and labor, it costs GCI \$0.23 per cubic foot to build a crate. In turn, they charge their customers \$0.50 per cubic foot for the crate. You have been asked to write a program that calculates the volume (in cubic feet), cost, customer price, and profit of any crate GCI builds.

### Variables

**Table 3-14**  shows the named constants and variables needed.

**Table 3-14 Named Constants and Variables**

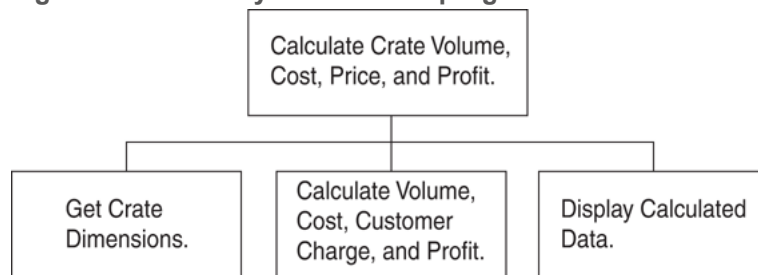
# Program Design

The program must perform the following general steps:

1. Ask the user to enter the dimensions of the crate (the crate's length, width, and height).
2. Calculate the crate's volume, the cost of building the crate, the customer's charge, and the profit made.
3. Display the data calculated in Step 2.

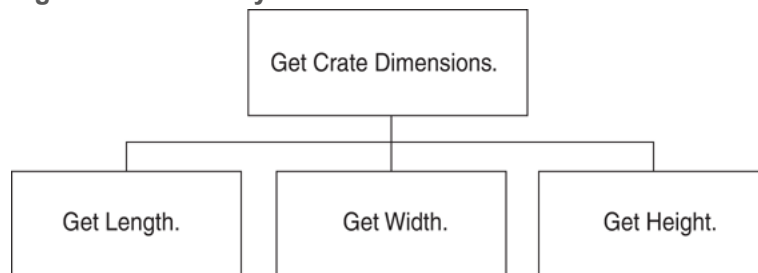
A general hierarchy chart for this program is shown in [Figure 3-7](#).

**Figure 3-7 Hierarchy chart for the program**



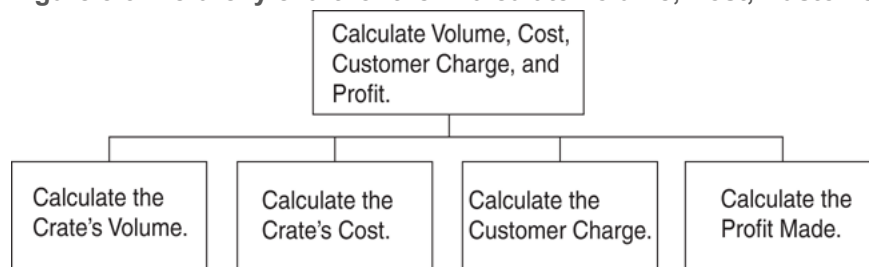
The “Get Crate Dimensions” step is shown in greater detail in [Figure 3-8](#).

**Figure 3-8 Hierarchy chart for the “Get Crate Dimensions” step**



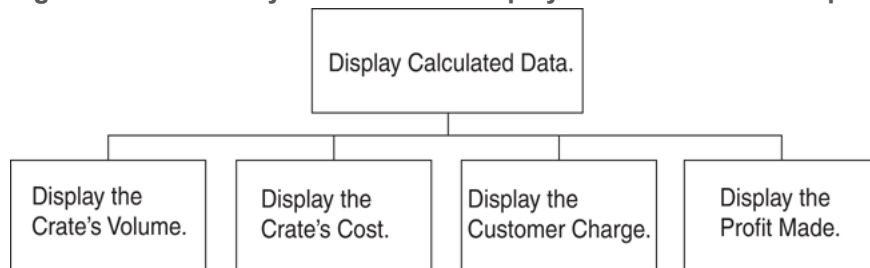
The “Calculate Volume, Cost, Customer Charge, and Profit” step is shown in greater detail in [Figure 3-9](#).

**Figure 3-9 Hierarchy chart for the “Calculate Volume, Cost, Customer Charge, and Profit” step**



The “Display Calculated Data” step is shown in greater detail in [Figure 3-10](#).

**Figure 3-10** Hierarchy chart for the “Display Calculated Data” step



Pseudocode for the program is as follows:

```
Ask the user to input the crate's length.  
Ask the user to input the crate's width.  
Ask the user to input the crate's height.  
Calculate the crate's volume.  
Calculate the cost of building the crate.  
Calculate the customer's charge for the crate.  
Calculate the profit made from the crate.  
Display the crate's volume.  
Display the cost of building the crate.  
Display the customer's charge for the crate.  
Display the profit made from the crate.
```

## Calculations

The following formulas will be used to calculate the crate’s volume, cost, charge, and profit:


$$\text{volume} = \text{length} \times \text{width} \times \text{height}$$

$$\text{cost} = \text{volume} \times 0.23$$

$$\text{charge} = \text{volume} \times 0.5$$

$$\text{profit} = \text{charge} - \text{cost}$$

# The Program

The last step is to expand the pseudocode into the final program, which is shown in [Program 3-28](#) .

## Program 3-28

```
1 // This program is used by General Crates, Inc. to calculate
2 // the volume, cost, customer charge, and profit of a crate
3 // of any size. It calculates this data from user input, which
4 // consists of the dimensions of the crate.
5 #include <iostream>
6 #include <iomanip>
7 using namespace std;
8
9 int main()
10 {
11     // Constants for cost and amount charged
12     const double COST_PER_CUBIC_FOOT = 0.23;
13     const double CHARGE_PER_CUBIC_FOOT = 0.5;
14
15     // Variables
16     double length, // The crate's length
17            width,   // The crate's width
18            height, // The crate's height
19            volume, // The volume of the crate
20            cost,   // The cost to build the crate
21            charge, // The customer charge for the crate
22            profit; // The profit made on the crate
23
24     // Set the desired output formatting for numbers.
25     cout << setprecision(2) << fixed << showpoint;
26
27     // Prompt the user for the crate's length, width, and height.
28     cout << "Enter the dimensions of the crate (in feet):\n";
29     cout << "Length: ";
30     cin >> length;
31     cout << "Width: ";
32     cin >> width;
33     cout << "Height: ";
34     cin >> height;
35
36     // Calculate the crate's volume, the cost to produce it,
37     // the charge to the customer, and the profit.
```



```
38     volume = length * width * height;
39     cost = volume * COST_PER_CUBIC FOOT;
40     charge = volume * CHARGE_PER_CUBIC FOOT;
41     profit = charge - cost;
42
43     // Display the calculated data.
44     cout << "The volume of the crate is ";
45     cout << volume << " cubic feet.\n";
46     cout << "Cost to build: $" << cost << endl;
47     cout << "Charge to customer: $" << charge << endl;
48     cout << "Profit: $" << profit << endl;
49     return 0;
50 }
```

### Program Output with Example Input Shown in Bold

```
Enter the dimensions of the crate (in feet):
Length: 10 Enter
Width: 8 Enter
Height: 4 Enter
The volume of the crate is 320.00 cubic feet.
Cost to build: $73.60
Charge to customer: $160.00
Profit: $86.40
```

### Program Output with Different Example Input Shown in Bold

```
Enter the dimensions of the crate (in feet):
Length: 12.5 Enter
Width: 10.5 Enter
Height: 8 Enter
The volume of the crate is 1050.00 cubic feet.
Cost to build: $241.50
Charge to customer: $525.00
Profit: $283.50
```

# Review Questions and Exercises

## Short Answer

1. Assume the following variables are defined:

```
int age;  
double pay;  
char section;
```

Write a single `cin` statement that will read input into each of these variables.

2. Assume a `string` object has been defined as follows:

```
string description;
```

- A. Write a `cin` statement that reads in a one-word string.
  - B. Write a statement that reads in a string that can contain multiple words separated by blanks.
3. What header files must be included in the following program?

```
int main()
{
    double amount = 89.7;
    cout << showpoint << fixed;
    cout << setw(8) << amount << endl;
    return 0;
}
```

- Complete the following table by determining the value of each expression.
- Write C++ expressions for the following algebraic expressions:

$$a = 12x$$

$$z = 5x + 14y + 6k$$

$$y = x^4$$

$$g = \frac{h+12}{4k}$$

$$c = \frac{a^3}{b^2k^4}$$

- Assume a program has the following variable definitions:

```
int units;
float mass;
double weight;
```

and the following statement:

```
weight = mass * units;
```

Which automatic data type conversion will take place?

- A. `mass` is demoted to an `int`, `units` remains an `int`, and the result of `mass * units` is an `int`.
- B. `units` is promoted to a `float`, `mass` remains a `float`, and the result of `mass * units` is a `float`.
- C. `units` is promoted to a `float`, `mass` remains a `float`, and the result of `mass * units` is a `double`.

7. Assume a program has the following variable definitions:

```
int a, b = 2;
```

```
float c = 4.2;
```

and the following statement:

```
a = b * c;
```

What value will be stored in `a`?

- A. 8.4
- B. 8
- C. 0
- D. None of the above

8. Assume `qty` and `salesReps` are both integers. Use a type cast expression to rewrite the following statement so it will no longer perform integer division.

```
unitsEach = qty / salesReps;
```

9. Rewrite the following variable definition so that the variable is a named constant.

```
int rate;
```

10. Complete the following table by providing statements with combined assignment operators for the right-hand column. The statements should be equivalent to the statements in the left-hand column.
11. Write a multiple assignment statement that can be used instead of the following group of assignment statements:

```
east = 1;
```

```
west = 1;
```

```
north = 1;
```

```
south = 1;
```

12. Write a `cout` statement so the variable `divSales` is displayed in a field of 8 spaces, in fixed-point notation, with a precision

of 2 decimal places. The decimal point should always be displayed.

13. Write a `cout` statement so the variable `totalAge` is displayed in a field of 12 spaces, in fixed-point notation, with a precision of 4 decimal places.
14. Write a `cout` statement so the variable `population` is displayed in a field of 12 spaces, left-justified, with a precision of 8 decimal places. The decimal point should always be displayed.

# Fill-in-the-Blank

15. The \_\_\_\_\_ library function returns the cosine of an angle.
16. The \_\_\_\_\_ library function returns the sine of an angle.
17. The \_\_\_\_\_ library function returns the tangent of an angle.
18. The \_\_\_\_\_ library function returns the exponential function of a number.
19. The \_\_\_\_\_ library function returns the remainder of a floating-point division.
20. The \_\_\_\_\_ library function returns the natural logarithm of a number.
21. The \_\_\_\_\_ library function returns the base-10 logarithm of a number.
22. The \_\_\_\_\_ library function returns the value of a number raised to a power.
23. The \_\_\_\_\_ library function returns the square root of a number.
24. The \_\_\_\_\_ file must be included in a program that uses the mathematical functions.

# Algorithm Workbench

25. A retail store grants its customers a maximum amount of credit. Each customer's available credit is his or her maximum amount of credit minus the amount of credit used. Write a pseudocode algorithm for a program that asks for a customer's maximum amount of credit and amount of credit used. The program should then display the customer's available credit.

After you write the pseudocode algorithm, convert it to a complete C++ program.

26. Write a pseudocode algorithm for a program that calculates the total of a retail sale. The program should ask for the amount of the sale and the sales tax rate. The sales tax rate should be entered as a floating-point number. For example, if the sales tax rate is 6 percent, the user should enter 0.06. The program should display the amount of sales tax and the total of the sale.

After you write the pseudocode algorithm, convert it to a complete C++ program.

27. Write a pseudocode algorithm for a program that asks the user to enter a golfer's score for three games of golf, and then displays the average of the three scores.

After you write the pseudocode algorithm, convert it to a complete C++ program.



# Find the Errors

Each of the following programs has some errors. Locate as many as you can.

28.

```
using namespace std;
int main ()
{
    double number1, number2, sum;
    Cout << "Enter a number: ";
    Cin << number1;
    Cout << "Enter another number: ";
    Cin << number2;
    number1 + number2 = sum;
    Cout "The sum of the two numbers is " << sum
    return 0;
}
```

29.

```
#include <iostream>
using namespace std;
int main()
{
    int number1, number2;
    float quotient;
    cout << "Enter two numbers and I will divide\n";
    cout << "the first by the second for you.\n";
    cin >> number1, number2;
    quotient = float<static_cast>(number1) / number2;
    cout << quotient
    return 0;
}
```

30.

```
#include <iostream>
using namespace std;
int main()
{
    const int number1, number2, product;
    cout << "Enter two numbers and I will multiply\n";
    cout << "them for you.\n";
    cin >> number1 >> number2;
    product = number1 * number2;
    cout << product
    return 0;
}
```

31.

```
#include <iostream>
using namespace std;
main
{
    int number1, number2;
    cout << "Enter two numbers and I will multiply\n"
    cout << "them by 50 for you.\n"
    cin >> number1 >> number2;
    number1 *= 50;
    number2 *= 50;
    cout << number1 << " " << number2;
    return 0;
}
```

32.

```
#include <iostream>;  
using namespace std;  
main  
{  
    double number, half;  
    cout << "Enter a number and I will divide it\n"  
    cout << "in half for you.\n"  
    cin >> number1;  
    half =/ 2;  
    cout << fixedpoint << showpoint << half << endl;  
    return 0;  
}
```

33.

```
#include <iostream>;  
using namespace std;  
int main()  
{  
    char name, go;  
    cout << "Enter your name: ";  
    getline >> name;  
    cout << "Hi " << name << endl;  
    return 0;  
}
```

# Predict the Output

What will each of the following programs display? (Some should be hand traced and require a calculator.)

34. (Assume the user enters 38700. Use a calculator.)

```
#include <iostream>
using namespace std;
int main()
{
    double salary, monthly;
    cout << "What is your annual salary? ";
    cin >> salary;
    monthly = static_cast<int>(salary) / 12;
    cout << "Your monthly wages are " << monthly << endl;
    return 0;
}
```

35.

```
#include <iostream>
using namespace std;
int main()
{
    long x, y, z;

    x = y = z = 4;
    x += 2;
    y -= 1;
    z *= 3;

    cout << x << " " << y << " " << z << endl;

    return 0;
}
```

36. (Assume the user enters George Washington.)

```
#include <iostream>
#include <iomanip>
#include <string>
using namespace std;
int main()
{
    string userInput;
    cout << "What is your name? ";
    getline(cin, userInput);
    cout << "Hello " << userInput << endl;
    return 0;
}
```

37. (Assume the user enters 36720152. Use a calculator.)



```
#include <iostream>
#include <iomanip>
using namespace std;
int main()
{
    long seconds;
    double minutes, hours, days, months, years;

    cout << "Enter the number of seconds that have\n";
    cout << "elapsed since some time in the past and\n";
    cout << "I will tell you how many minutes, hours,\n";
    cout << "days, months, and years have passed: ";
    cin >> seconds;
    minutes = seconds / 60;
    hours = minutes / 60;
    days = hours / 24;
    years = days / 365;
    months = years * 12;

    cout << setprecision(4) << fixed << showpoint <<
right;

    cout << "Minutes: " << setw(6) << minutes << endl;
    cout << "Hours: " << setw(6) << hours << endl;
    cout << "Days: " << setw(6) << days << endl;
    cout << "Months: " << setw(6) << months << endl;
    cout << "Years: " << setw(6) << years << endl;
```

```
return 0;
```

```
}
```

# Programming Challenges

## 1. Miles per Gallon

Write a program that calculates a car's gas mileage. The program should ask the user to enter the number of gallons of gas the car can hold, and the number of miles it can be driven on a full tank. It should then display the number of miles that may be driven per gallon of gas.



## Solving the Stadium Seating Problem

## 2. Stadium Seating

There are three seating categories at a stadium. For a softball game, Class A seats cost \$15, Class B seats cost \$12, and Class C seats cost \$9. Write a program that asks how many tickets for each class of seats were sold, then displays the amount of income generated from ticket sales. Format your dollar amount in fixed-point notation, with two decimal places

of precision, and be sure the decimal point is always displayed.

### 3. **Test Average**

Write a program that asks for five test scores. The program should calculate the average test score and display it. The number displayed should be formatted in fixed-point notation, with one decimal point of precision.

### 4. **Average Rainfall**

Write a program that calculates the average rainfall for three months. The program should ask the user to enter the name of each month, such as June or July, and the amount of rain (in inches) that fell each month. The program should display a message similar to the following:

The average rainfall for June, July, and August is 6.72 inches.

### 5. **Male and Female Percentages**

Write a program that asks the user for the number of males and the number of females registered in a class. The program should display the percentage of males and females in the class.

*Hint: Suppose there are 8 males and 12 females in a class.*

*There are 20 students in the class. The percentage of males can be calculated as  $8 \div 20 = 0.4$ , or 40 percent. The percentage of females can be calculated as  $12 \div 20 = 0.6$ , or 60 percent.*

### 6. **Ingredient Adjuster**

A cookie recipe calls for the following ingredients:

- 1.5 cups of sugar
- 1 cup of butter

- 2.75 cups of flour

The recipe produces 48 cookies with this amount of the ingredients. Write a program that asks the user how many cookies he or she wants to make, then displays the number of cups of each ingredient needed for the specified number of cookies.

## 7. **Box Office**

A movie theater only keeps a percentage of the revenue earned from ticket sales. The remainder goes to the movie distributor. Write a program that calculates a theater's gross and net box office profit for a night. The program should ask for the name of the movie, and how many adult and child tickets were sold. (The price of an adult ticket is \$10.00 and a child's ticket is \$6.00.) It should display a report similar to:



### **Note:**

Assume the theater keeps 20 percent of the gross box office profit.

## 8. **How Many Widgets?**

The Yukon Widget Company manufactures widgets that weigh 12.5 pounds each. Write a program that calculates how many widgets are stacked on a pallet, based on the total weight of the pallet. The program should ask the user how much the pallet weighs by itself and with the widgets stacked

on it. It should then calculate and display the number of widgets stacked on the pallet.

**9. How Many Calories?**

A bag of cookies holds 30 cookies. The calorie information on the bag claims there are 10 “servings” in the bag and that a serving equals 300 calories. Write a program that asks the user to input how many cookies he or she actually ate, then reports how many total calories were consumed.

**10. How Much Insurance?**

Many financial experts advise that property owners should insure their homes or buildings for at least 80 percent of the amount it would cost to replace the structure. Write a program that asks the user to enter the replacement cost of a building, then displays the minimum amount of insurance he or she should buy for the property.

**11. Automobile Costs**

Write a program that asks the user to enter the monthly costs for the following expenses incurred from operating his or her automobile: loan payment, insurance, gas, oil, tires, and maintenance. The program should then display the total monthly cost of these expenses, and the total annual cost of these expenses.

**12. Celsius to Fahrenheit**

Write a program that converts Celsius temperatures to Fahrenheit temperatures. The formula is

$$F = \frac{9}{5}C + 32$$

$F$  is the Fahrenheit temperature, and  $C$  is the Celsius temperature.

### 13. **Currency**

Write a program that will convert U.S. dollar amounts to Japanese yen and to euros, storing the conversion factors in the constants `YEN_PER_DOLLAR` and `EUROS_PER_DOLLAR`. To get the most up-to-date exchange rates, search the Internet using the term “currency exchange rate”. If you cannot find the most recent exchange rates, use the following:

1 Dollar = 98.93 Yen

1 Dollar = 0.74 Euros

Format your currency amounts in fixed-point notation, with two decimal places of precision, and be sure the decimal point is always displayed.

### 14. **Monthly Sales Tax**

A retail company must file a monthly sales tax report listing the sales for the month and the amount of sales tax collected. Write a program that asks for the month, the year, and the total amount collected at the cash register (i.e. sales plus sales tax). Assume the state sales tax is 4 percent, and the county sales tax is 2 percent.

If the total amount collected is known and the total sales tax is 6 percent, the amount of product sales may be calculated as:

$$S = \frac{T}{1.06}$$

$S$  is the product sales and  $T$  is the total income (product sales plus sales tax).

The program should display a report similar to:

```
Month: October
-----
Total Collected:    $ 26572.89
Sales:               $ 25068.76
County Sales Tax:   $   501.38
State Sales Tax:    $  1002.75
Total Sales Tax:    $   1504.13
```

### 15. **Property Tax**

A county collects property taxes on the assessment value of property, which is 60 percent of the property's actual value. If an acre of land is valued at \$10,000, its assessment value is \$6,000. The property tax is then 75¢ for each \$100 of the assessment value. The tax for the acre assessed at \$6,000 will be \$45. Write a program that asks for the actual value of a piece of property, then displays the assessment value and property tax.

### 16. **Senior Citizen Property Tax**

Madison County provides a \$5,000 homeowner exemption for its senior citizens. For example, if a senior's house is valued at \$158,000, its assessed value would be \$94,800, as explained above. However, he would only pay tax on \$89,800. At last year's tax rate of \$2.64 for each \$100 of assessed value, the property tax would be \$2,370.72. In addition to the



tax break, senior citizens are allowed to pay their property tax in four equal payments. The quarterly payment due on this property would be \$592.68. Write a program that asks the user to input the actual value of a piece of property and the current tax rate for each \$100 of assessed value. The program should then calculate and report how much annual property tax a senior homeowner will be charged for this property, and what the quarterly tax bill will be.

### 17. **Math Tutor**

Write a program that can be used as a math tutor for a young student. The program should display two random numbers to be added, such as

$$\begin{array}{r} 247 \\ +129 \\ \hline \end{array}$$

The program should then pause while the student works on the problem. When the student is ready to check the answer, he or she can press a key and the program will display the correct solution:

$$\begin{array}{r} 247 \\ +129 \\ \hline 376 \end{array}$$

### 18. **Interest Earned**

Assuming there are no deposits other than the original investment, the balance in a savings account after one year

may be calculated as

$$\text{Amount} = \text{Principal} \times \left(1 + \frac{\text{Rate}}{\text{T}}\right)^{\text{T}}$$

`Principal` is the balance in the savings account, `Rate` is the interest rate, and `T` is the number of times the interest is compounded during a year (`T` is 4 if the interest is compounded quarterly).

Write a program that asks for the principal, the interest rate, and the number of times the interest is compounded. It should display a report similar to:

```
Interest Rate:          4.25%
Times Compounded:      12
Principal:              $ 1000.00
Interest:               $   43.34
Amount in Savings:     $ 1043.34
```

## 19. Monthly Payments

The monthly payment on a loan may be calculated by the following formula:

$$\text{Payment} = \frac{\text{Rate} \times (1 + \text{Rate})^{\text{N}}}{\left((1 + \text{Rate})^{\text{N}} - 1\right)}$$

`Rate` is the monthly interest rate, which is the annual interest rate divided by 12. (12 percent annual interest would be 1 percent monthly interest.) `N` is the number of payments, and `L` is the amount of the loan. Write a program that asks for these values then displays a report similar to:

```
Loan Amount:           $ 10000.00
Monthly Interest Rate: 1%
Number of Payments:   36
Monthly Payment:      $   332.14
Amount Paid Back:     $ 11957.15
Interest Paid:        $   1957.15
```

## 20. Pizza Pi

Joe's Pizza Palace needs a program to calculate the number of slices a pizza of any size can be divided into. The program should perform the following steps:

- A. Ask the user for the diameter of the pizza in inches.
- B. Calculate the number of slices that may be taken from a pizza of that size.
- C. Display a message telling the number of slices.

To calculate the number of slices that may be taken from the pizza, you must know the following facts:

- Each slice should have an area of 14.125 inches.

- To calculate the number of slices, simply divide the area of the pizza by 14.125.
- The area of the pizza is calculated with this formula:

$$\text{Area} = \pi r^2$$



### Note:

$\pi$  is the Greek letter pi. 3.14159 can be used as its value. The variable  $r$  is the radius of the pizza. Divide the diameter by 2 to get the radius.

Make sure the output of the program displays the number of slices in fixed-point notation, rounded to one decimal place of precision. Use a named constant for pi.

## 21. How Many Pizzas?

Modify the program you wrote in Programming Challenge 20 (Pizza Pi) so it reports the number of pizzas you need to buy for a party if each person attending is expected to eat an average of four slices. The program should ask the user for the number of people who will be at the party, and for the diameter of the pizzas to be ordered. It should then calculate and display the number of pizzas to purchase.

## 22. Angle Calculator

Write a program that asks the user for an angle, entered in radians. The program should then display the sine, cosine,

and tangent of the angle. (Use the `sin`, `cos`, and `tan` library functions to determine these values.) The output should be displayed in fixed-point notation, rounded to four decimal places of precision.

### 23. **Stock Transaction Program**

Last month Joe purchased some stock in Acme Software, Inc. Here are the details of the purchase:

- The number of shares that Joe purchased was 1,000.
- When Joe purchased the stock, he paid \$45.50 per share.
- Joe paid his stockbroker a commission that amounted to 2 percent of the amount he paid for the stock.

Two weeks later, Joe sold the stock. Here are the details of the sale:

- The number of shares that Joe sold was 1,000.
- He sold the stock for \$56.90 per share.
- He paid his stockbroker another commission that amounted to 2 percent of the amount he received for the stock.

Write a program that displays the following information:

- The amount of money Joe paid for the stock.
- The amount of commission Joe paid his broker when he bought the stock.
- The amount that Joe sold the stock for.
- The amount of commission Joe paid his broker when he sold the stock.

- Display the amount of profit that Joe made after selling his stock and paying the two commissions to his broker. (If the amount of profit that your program displays is a negative number, then Joe lost money on the transaction.)

## 24. Planting Grapevines

A vineyard owner is planting several new rows of grapevines, and needs to know how many grapevines to plant in each row. She has determined that after measuring the length of a future row, she can use the following formula to calculate the number of vines that will fit in the row, along with the trellis end-post assemblies that will need to be constructed at each end of the row:

$$V = \frac{R - 2E}{S}$$

The terms in the formula are:

$V$  is the number of grapevines that will fit in the row.

$R$  is the length of the row, in feet.

$E$  is the amount of space, in feet, used by an end-post assembly.

$S$  is the space between vines, in feet.

Write a program that makes the calculation for the vineyard owner. The program should ask the user to input the following:

- The length of the row, in feet

- The amount of space used by an end-post assembly, in feet
- The amount of space between the vines, in feet

Once the input data has been entered, the program should calculate and display the number of grapevines that will fit in the row.

## 25. Word Game

Write a program that plays a word game with the user. The program should ask the user to enter the following:

- His or her name
- His or her age
- The name of a city
- The name of a college
- A profession
- A type of animal
- A pet's name

After the user has entered these items, the program should display the following story, inserting the user's input into the appropriate locations:

```
There once was a person named NAME who lived in CITY. At  
the age of AGE, NAME went to college at COLLEGE. NAME  
graduated and went to work as a PROFESSION. Then, NAME  
adopted a(n) ANIMAL named PETNAME. They both lived  
happily ever after!
```

---

# Chapter 4 Making Decisions

---

## Topics

4.1 Relational Operators [📄](#)

4.2 The `if` Statement [📄](#)

4.3 Expanding the `if` Statement [📄](#)

4.4 The `if/else` Statement [📄](#)

4.5 Nested `if` Statements [📄](#)

4.6 The `if/else if` Statement [📄](#)

4.7 Flags [📄](#)

4.8 Logical Operators [📄](#)

4.9 Checking Numeric Ranges with Logical Operators [📄](#)

4.10 Menus [📄](#)

4.11 Focus on Software Engineering: Validating User Input [📄](#)



**4.12 Comparing Characters and Strings** 

**4.13 The Conditional Operator** 

**4.14 The `switch` Statement** 

**4.15 More about Blocks and Variable Scope** 

# 4.1 Relational Operators

## Concept:

Relational operators allow you to compare numeric and `char` values and determine whether one is greater than, less than, equal to, or not equal to another.

So far, the programs you have written follow this simple scheme:

- Gather input from the user.
- Perform one or more calculations.
- Display the results on the screen.

Computers are good at performing calculations, but they are also quite adept at comparing values to determine whether one is greater than, less than, or equal to the other. These types of operations are valuable for tasks such as examining sales figures, determining profit and loss, checking a number to ensure it is within an acceptable range, and validating the input given by a user.

Numeric data is compared in C++ by using relational operators. Each relational operator determines whether a specific relationship

exists between two values. For example, the greater-than operator (`>`) determines if a value is greater than another. The equality operator (`==`) determines if two values are equal. [Table 4-1](#) lists all of C++'s relational operators.

### Table 4-1 Relational Operators

All of the relational operators are binary, which means they use two operands. Here is an example of an expression using the greater-than operator:

```
x > y
```

This expression is called a *relational expression*. It is used to determine whether `x` is greater than `y`. The following expression determines whether `x` is less than `y`:

```
x < y
```

[Table 4-2](#) shows examples of several relational expressions that compare the variables `x` and `y`.

### Table 4-2 Relational Expressions



## Note:

All the relational operators have left-to-right associativity. Recall that associativity is the order in which an operator works with its operands.

# The Value of a Relationship

So, how are relational expressions used in a program? Remember, all expressions have a value. Relational expressions are also known as *Boolean expressions*, which means their value can only be *true* or *false*. If `x` is greater than `y`, the expression `x > y` will be true, while the expression `y == x` will be false.

The `==` operator determines whether the operand on its left is equal to the operand on its right. If both operands have the same value, the expression is true. Assuming that `a` is 4, the following expression is true:

```
a == 4
```

But the following is false:

```
a == 2
```



## **Warning!**

Notice the equality operator is two `=` symbols together. Don't confuse this operator with the assignment operator, which is one `=` symbol. The `==` operator determines whether a variable is equal to another value, but the `=` operator assigns the value on the operator's right to the variable on its left. There will be more about this later in the chapter.

A couple of the relational operators actually test for two relationships. The `>=` operator determines whether the operand on its left is greater than *or* equal to the operand on the right. Assuming `a` is 4, `b` is 6, and `c` is 4, both of the following expressions are true:

```
b >= a
```

```
a >= c
```

But the following is false:

```
a >= 5
```

The `<=` operator determines whether the operand on its left is less than *or* equal to the operand on its right. Once again, assuming `a` is 4, `b` is 6, and `c` is 4, both of the following expressions are true:

```
a <= c  
b <= 10
```

But the following is false:


```
b <= a
```

The last relational operator is `!=`, which is the not-equal-to operator. It determines whether the operand on its left is not equal to the operand on its right, which is the opposite of the `==` operator. As before, assuming `a` is 4, `b` is 6, and `c` is 4, both of the following expressions are true:

```
a != b  
b != c
```

These expressions are true because `a` is *not* equal to `b` and `b` is *not* equal to `c`. But the following expression is false because `a` is equal to `c`:

```
a != c
```

**Table 4-3**  shows other relational expressions and their true or false values.

**Table 4-3 (Assume `x` is 10 and `y` is 7.)**



# What Is Truth?

The question “what is truth?” is one you would expect to find in a philosophy book, not a C++ programming text. It’s a good question for us to consider, though. If a relational expression can be either true or false, how are those values represented internally in a program? How does a computer store *true* in memory? How does it store *false*?

As you saw in [Program 2-17](#), those two abstract states are converted to numbers. In C++, relational expressions represent true states with the number 1, and false states with the number 0.



## **Note:**

As you will see later in this chapter, 1 is not the only value regarded as true.

To illustrate this more fully, look at [Program 4-1](#).

## Program 4-1

```
1 // This program displays the values of true
and false states.
2 #include <iostream>
3 using namespace std;
4
5 int main()
6 {
7     bool trueValue, falseValue;
8     int x = 5, y = 10;
9
10    trueValue = x < y;
11    falseValue = y == x;
12
13    cout << "True is " << trueValue << endl;
14    cout << "False is " << falseValue << endl;
15    return 0;
16 }
```

## Program Output

```
True is 1
False is 0
```

Let's examine the statements containing the relational expressions, in lines 10 and 11, a little closer:

```
trueValue = x < y;
falseValue = y == x;
```

These statements may seem odd because they are assigning the value of a comparison to a variable. In line 10, the variable `trueValue` is being assigned the result of `x < y`. Since `x` is less than `y`, the expression is true, and the variable `trueValue` is assigned the value 1. In line 11, the expression `y == x` is false, so the variable `falseValue` is set to 0. [Table 4-4](#) shows examples of other statements using relational expressions and their outcomes.

**Table 4-4 (Assume `x` is 10, `y` is 7, and `z`, `a`, and `b` are `ints` or `bool s`.)**



## Note:

Relational expressions have a higher precedence than the assignment operator. In the statement

```
z = x < y ;
```

the expression `x < y` is evaluated first, then its value is assigned to `z`.

When writing statements such as these, it sometimes helps to enclose the relational expression in parentheses, such as:

```
trueValue = (x < y);  
falseValue = (y == x);
```

As interesting as relational expressions are, we've only scratched the surface of how to use them. In this chapter's remaining sections, you will see how to get the most from relational expressions by using them in statements that take action based on the results of the comparison.



## Checkpoint

4.1 Assuming  $x$  is 5,  $y$  is 6, and  $z$  is 8, indicate whether each of the following relational expressions is true or false:

- A.  $x == 5$
- B.  $7 <= (x + 2)$
- C.  $z < 4$
- D.  $(2 + x) != y$
- E.  $z != 4$
- F.  $x >= 9$
- G.  $x <= (y * 2)$

4.2 Indicate whether the following statements about relational expressions are correct or incorrect:

- A.  $x <= y$  is the same as  $y > x$ .
- B.  $x != y$  is the same as  $y >= x$ .
- C.  $x >= y$  is the same as  $y <= x$ .

4.3 Answer the following questions with a yes or no:

- A. If it is true that  $x > y$  and it is also true that  $x < z$ , does that mean  $y < z$  is true?
- B. If it is true that  $x >= y$  and it is also true that  $z == x$ , does that mean that  $z == y$  is true?
- C. If it is true that  $x != y$  and it is also true that  $x != z$ , does that mean that  $z != y$  is true?

#### 4.4 What will the following program display?

```
#include <iostream>
using namespace std;
int main ()
{
    int a = 0, b = 2, x = 4, y = 0;
    cout << (a == b) << endl;
    cout << (a != y) << endl;
    cout << (b <= x) << endl;
    cout << (y > a) << endl;
    return 0;
}
```

## 4.2 The `if` Statement

### Concept:

The `if` statement can cause other statements to execute only under certain conditions.

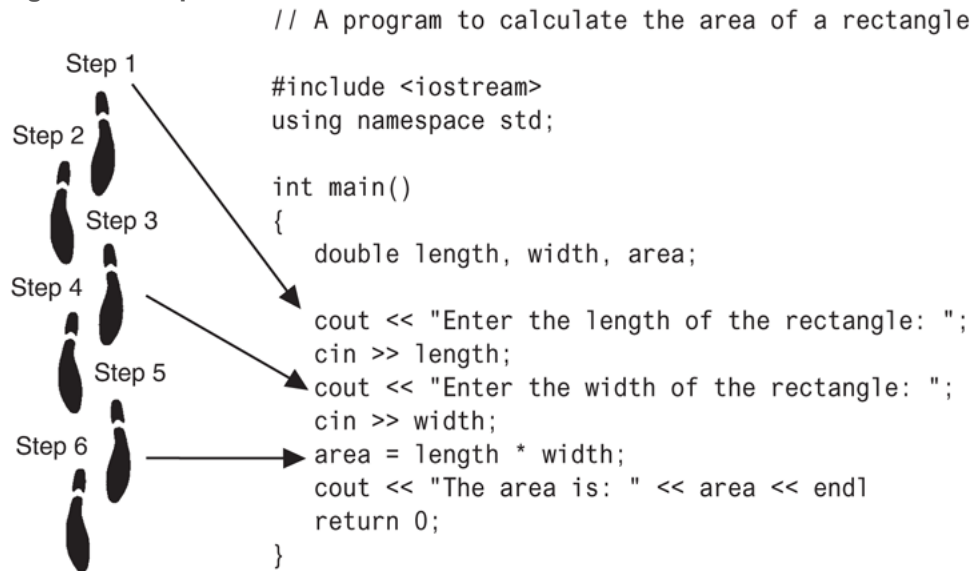
You might think of the statements in a procedural program as individual steps taken as you are walking down a road. To reach the destination, you must start at the beginning and take each step, one after the other, until you reach the destination. The programs you have written so far are like a “path” of execution for the program to follow.



### The `if` Statement

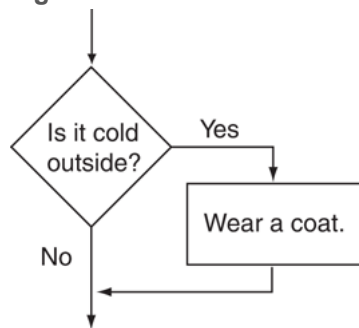
The type of code in [Figure 4-1](#) is called a *sequence structure* because the statements are executed in sequence, without branching off in another direction. Programs often need more than one path of execution, however. Many algorithms require a program to execute some statements only under certain circumstances. This can be accomplished with a *decision structure*.

**Figure 4-1 Sequence structure**



In a decision structure's simplest form, a specific action is taken only when a specific condition exists. If the condition does not exist, the action is not performed. The flowchart in [Figure 4-2](#) shows the logic of a decision structure. The diamond symbol represents a yes/no question or a true/false condition. If the answer to the question is yes (or if the condition is true), the program flow follows one path, which leads to an action being performed. If the answer to the question is no (or the condition is false), the program flow follows another path, which skips the action.

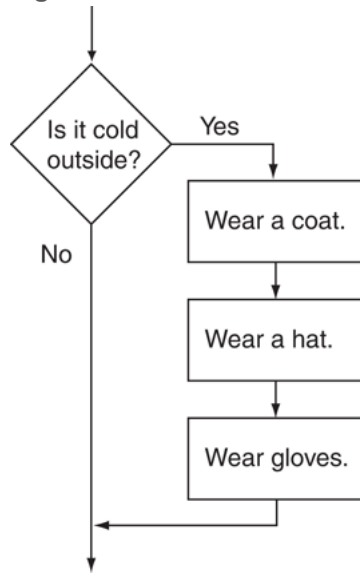
**Figure 4-2 Decision structure**



In the flowchart, the action “Wear a coat” is performed only when it is cold outside. If it is not cold outside, the action is skipped. The action is *conditionally executed* because it is performed only when a certain condition (cold outside) exists. [Figure 4-3](#) shows a more elaborate flowchart, where three actions are taken only when it is cold outside.



Figure 4-3 Decision structure



We perform mental tests like these every day. Here are some other examples:

If the car is low on gas, stop at a service station and get gas.

If it's raining outside, go inside.

If you're hungry, get something to eat.

One way to code a decision structure in C++ is with the `if` statement. Here is the general format of the `if` statement:

```
if (expression)
    statement;
```

The `if` statement is simple in the way it works: If the value of the expression inside the parentheses is true, the very next `statement` is executed. Otherwise, it is skipped. The `statement` is *conditionally executed* because it only executes under the condition that the expression in the parentheses is true. [Program 4-2](#) shows an example of an `if` statement. The user enters three test scores, and the program calculates their average. If the average is greater than 95, the program congratulates the user on obtaining a high score.

## Program 4-2

```
1 // This program averages three test scores
2 #include <iostream>
3 #include <iomanip>
4 using namespace std;
5
6 int main()
7 {
8     const int HIGH_SCORE = 95; // A high score is 95 or greater
9     int score1, score2, score3; // To hold three test scores
10    double average; // To hold the average score
11
12    // Get the three test scores.
13    cout << "Enter 3 test scores and I will average them: ";
14    cin >> score1 >> score2 >> score3;
15
16    // Calculate and display the average score.
17    average = (score1 + score2 + score3) / 3.0;
18    cout << fixed << showpoint << setprecision(1);
19    cout << "Your average is " << average << endl;
20
21    // If the average is a high score, congratulate the user.
22    if (average > HIGH_SCORE)
23        cout << "Congratulations! That's a high score!\n";
24    return 0;
25 }
```

### Program Output with Example Input Shown in Bold

```
Enter 3 test scores and I will average them: 80 90 70 Enter
Your average is 80.0
```

### Program Output with Different Example Input Shown in Bold

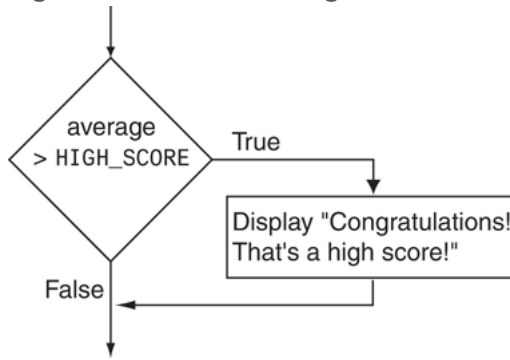
```
Enter 3 test scores and I will average them: 100 100 100 Enter
Your average is 100.0
Congratulations! That's a high score!
```

Lines 22 and 23 cause the congratulatory message to be printed:

```
if (average > HIGH_SCORE)
    cout << "Congratulations! That's a high score!\n";
```

The `cout` statement in line 23 is executed only if the average is greater than 95, the value of the `HIGH_SCORE` constant. If the average is not greater than 95, the `cout` statement is skipped. [Figure 4-4](#) shows the logic of this `if` statement.

**Figure 4-4** `if` statement logic



[Table 4-5](#) shows other examples of `if` statements and their outcomes.

**Table 4-5** `if` Statements and Their Outcomes

# Be Careful with Semicolons

Semicolons do not mark the end of a line, but the end of a complete C++ statement. The `if` statement isn't complete without the conditionally executed statement that comes after it. So, you must not put a semicolon after the `if (expression)` portion of an `if` statement.

No semicolon goes here.

```
if (expression)
    statement;
```

Semicolon goes here.

If you inadvertently put a semicolon after the `if` part, the compiler will assume you are placing a null statement there. The *null statement* is an empty statement that does nothing. This will prematurely terminate the `if` statement, which disconnects it from the statement that follows it. The statement following the `if` will always execute, as shown in [Program 4-3](#).

## Program 4-3

```
1 // This program demonstrates how a misplaced semicolon
2 // prematurely terminates an if statement.
3 #include <iostream>
4 using namespace std;
5
6 int main()
7 {
8     int x = 0, y = 10;
9
10    cout << "x is " << x << " and y is " << y << endl;
11    if (x > y); // Error! Misplaced semicolon
12        cout << "x is greater than y\n"; //This is always executed.
13    return 0;
14 }
```

## Program Output

```
x is 0 and y is 10
x is greater than y
```

# Programming Style and the `if` Statement

Even though `if` statements usually span more than one line, they are technically one long statement. For instance, the following `if` statements are identical except in style:

```
if (a >= 100)
    cout << "The number is out of range.\n";
if (a >= 100) cout << "The number is out of range.\n";
```

In both the examples above, the compiler considers the `if` part and the `cout` statement as one unit, with a semicolon properly placed at the end. Indention and spacing are for the human readers of a program, not the compiler. Here are two important style rules you should adopt for writing `if` statements:

- The conditionally executed statement should appear on the line after the `if` statement.
- The conditionally executed statement should be indented one “level” from the `if` statement.



## Note:

In most editors, each time you press the tab key, you are indenting one level.

By indenting the conditionally executed statement, you are causing it to stand out visually. This is so that you can tell at a glance what part of the program the `if` statement executes. This is a standard way of writing `if` statements, and is the method you should use.



## Note:

Indention and spacing are for the human readers of a program, not the compiler. Even though the `cout` statement following the `if` statement in [Program 4-3](#) is indented, the semicolon still terminates the `if` statement.

# Comparing Floating-Point Numbers

Because of the way floating-point numbers are stored in memory, rounding errors sometimes occur. This is because some fractional numbers cannot be exactly represented using binary. So, you should be careful when using the equality operator (`==`) to compare floating-point numbers. For example,

**Program 4-4** uses two `double` variables, `a` and `b`. Both variables are initialized to the value 1.5. Then, the value 0.0000000000000001 is added to `a`. This should make `a`'s contents different from `b`'s contents. Because of a round-off error, however, the two variables are still the same.

## Program 4-4

```
1 // This program demonstrates how floating-point
2 // round-off errors can make equality operations unreliable.
3 #include <iostream>
4 using namespace std;
5
6 int main()
7 {
8     double a = 1.5;           // a is 1.5.
9     double b = 1.5;           // b is 1.5.
10
11     a += 0.0000000000000001; // Add a little to a.
12     if (a == b)
13         cout << "Both a and b are the same.\n";
14     else
15         cout << "a and b are not the same.\n";
16
17     return 0;
18 }
```

## Program Output

```
Both a and b are the same.
```

To prevent round-off errors from causing this type of problem, you should stick with greater-than and less-than comparisons with floating-point numbers.



# And Now Back to Truth

Now that you've gotten your feet wet with relational expressions and `if` statements, let's look at the subject of truth again. You have seen that a relational expression has the value 1 when it is true and 0 when false. In the world of the `if` statement, however, the concept of truth is expanded. 0 is still false, but all values other than 0 are considered true. This means that any value, even a negative number, represents as true as long as it is not 0.

Just as in real life, truth is a complicated thing. Here is a summary of the rules you have seen so far:

- When a relational expression is true, it has the value 1.
- When a relational expression is false, it has the value 0.
- Any expression that has the value 0 is considered false by the `if` statement. This includes the `bool` value `false`, which is equivalent to 0.
- Any expression that has any value other than 0 is considered true by the `if` statement. This includes the `bool` value `true`, which is equivalent to 1.

The fact that the `if` statement considers any nonzero value as true opens many possibilities. Relational expressions are not the only conditions that may be tested. For example, the following is a legal `if` statement in C++:

```
if (value)
    cout << "It is True!";
```

The `if` statement above does not test a relational expression, but rather the contents of a variable. If the variable, `value`, contains any number other than 0, the message "It is True!" will be displayed. If `value` is set to 0, however, the `cout` statement will be skipped. Here is another example:

```
if (x + y)
    cout << "It is True!";
```

In this statement, the sum of `x` and `y` is tested like any other value in an `if` statement: 0 is false and all other values are true. You may also use the return value of function calls as conditional expressions. Here is an example that uses the `pow` function:

```
if (pow(a, b))  
    cout << "It is True!";
```

This `if` statement uses the `pow` function to raise `a` to the power of `b`. If the result is anything other than 0, the `cout` statement is executed. This is a powerful programming technique that you will learn more about in [Chapter 6](#).

## Don't Confuse `==` with `=`

Earlier you saw a warning not to confuse the equality operator `(==)` with the assignment operator `(=)`, as in the following statement:

```
if (x = 2) //Caution here!  
    cout << "It is True!";
```

The statement above does not determine whether `x` is equal to 2, it assigns `x` the value 2! Furthermore, the `cout` statement will *always* be executed because the expression `x = 2` is always true.

This occurs because the value of an assignment expression is the value being assigned to the variable on the left side of the `=` operator. That means the value of the expression `x = 2` is 2. Since 2 is a nonzero value, it is interpreted as a true condition by the `if` statement. [Program 4-5](#) is a version of [Program 4-2](#) that attempts to test for a perfect average of 100. The `=` operator, however, was mistakenly used in the `if` statement.

## Program 4-5

```
1 // This program averages 3 test scores. The if statement
2 // uses the = operator, but the == operator was intended.
3 #include <iostream>
4 #include <iomanip>
5 using namespace std;
6
7 int main()
8 {
9     int score1, score2, score3; // To hold three test scores
10    double average;           // To hold the average score
11
12    // Get the three test scores.
13    cout << "Enter 3 test scores and I will average them: ";
14    cin >> score1 >> score2 >> score3;
15
16    // Calculate and display the average score.
17    average = (score1 + score2 + score3) / 3.0;
18    cout << fixed << showpoint << setprecision(1);
19    cout << "Your average is " << average << endl;
20
21    // Our intention is to congratulate the user
22    // for having a perfect score. But, this doesn't work.
23    if (average = 100) // WRONG! This is an assignment!
24        cout << "Congratulations! That's a perfect score!\n";
25    return 0;
26 }
```

### Program Output with Example Input Shown in Bold

```
Enter three test scores and I will average them: 80 90 70 Enter
Your average is 80.0
Congratulations! That's a perfect score!
```

Regardless of the average score, this program will print the message congratulating the user on a perfect score.

## Checkpoint

4.5 Write an `if` statement that performs the following logic: if the variable `x` is equal to 20, then assign 0 to the variable `y`.

4.6 Write an `if` statement that performs the following logic: if the variable `price` is greater than 500, then assign 0.2 to the variable `discountRate`.

4.7 Write an `if` statement that multiplies `payRate` by 1.5 if `hours` is greater than 40.

4.8 True or False: Both of the following `if` statements perform the same operation.

```
if (sales > 10000)
    commissionRate = 0.15;
if (sales > 10000) commissionRate = 0.15;
```

4.9 True or false: Both of the following `if` statements perform the same operation.

```
if (calls == 20)
    rate *= 0.5;
if (calls = 20)
    rate *= 0.5;
```

## 4.3 Expanding the `if` Statement

### Concept:

The `if` statement can conditionally execute a block of statements enclosed in braces.

What if you want an `if` statement to conditionally execute a group of statements, not just one line? For instance, what if the test-averaging program needed to use several `cout` statements when a high score was reached? The answer is to enclose all of the conditionally executed statements inside a set of braces. Here is the format:

```
if (expression)
{
    statement;
    statement;
    // Place as many statements here as necessary.
}
```

**Program 4-6** , another modification of the test-averaging program, demonstrates this type of `if` statement.

## Program 4-6


```
1 // This program averages 3 test scores.
2 // It demonstrates an if statement executing
3 // a block of statements.
4 #include <iostream>
5 #include <iomanip>
6 using namespace std;
7
8 int main()
9 {
10     const int HIGH_SCORE = 95; // A high score is 95 or greater
11     int score1, score2, score3; // To hold three test scores
12     double average; // To hold the average score
13
14     // Get the three test scores.
15     cout << "Enter 3 test scores and I will average them: ";
16     cin >> score1 >> score2 >> score3;
17
18     // Calculate and display the average score.
19     average = (score1 + score2 + score3) / 3.0;
20     cout << fixed << showpoint << setprecision(1);
21     cout << "Your average is " << average << endl;
22
23     // If the average is high, congratulate the user.
24     if (average > HIGH_SCORE)
25     {
26         cout << "Congratulations!\n";
27         cout << "That's a high score.\n";
28         cout << "You deserve a pat on the back!\n";
29     }
30     return 0;
31 }
```

**Program Output with Example Input Shown in Bold**

```
Enter 3 test scores and I will average them: 100 100 100 Enter
Your average is 100.0
Congratulations!
That's a high score.
You deserve a pat on the back!
```

### Program Output with Different Example Input Shown in Bold

```
Enter 3 test scores and I will average them: 80 90 70 Enter
Your average is 80.0
```

**Program 4-6**  prints a more elaborate message when the average score is greater than 95. The `if` statement was expanded to execute three `cout` statements when `highScore` is set to `true`. Enclosing a group of statements inside a set of braces creates a *block* of code. The `if` statement will execute all the statements in the block, in the order they appear, only when `average` is greater than 95. Otherwise, the block will be skipped.

Notice all the statements inside the braces are indented. As before, this visually separates the statements from lines that are not indented, making it more obvious they are part of the `if` statement.



#### Note:

Anytime your program has a block of code, all the statements inside the braces should be indented.



# Don't Forget the Braces!

If you intend to conditionally execute a block of statements with an `if` statement, don't forget the braces. Remember, without a set of braces, the `if` statement only executes the very next statement.

**Program 4-7** [📄](#) shows the test-averaging program with the braces inadvertently left out of the `if` statement's block.

## Program 4-7

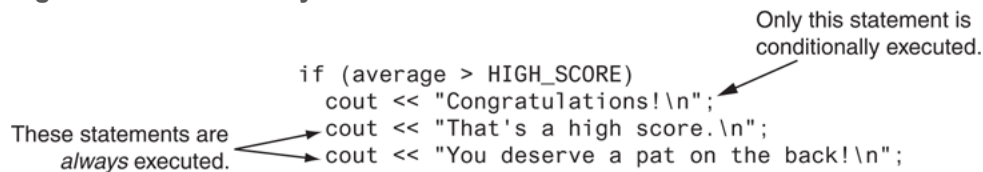
```
1 // This program averages 3 test scores. The braces
2 // were inadvertently left out of the if statement.
3 #include <iostream>
4 #include <iomanip>
5 using namespace std;
6
7 int main()
8 {
9     const int HIGH_SCORE = 95;          // A high score is 95 or greater
10    int score1, score2, score3;        // To hold three test scores
11    double average;                    // To hold the average score
12
13    // Get the three test scores.
14    cout << "Enter 3 test scores and I will average them: ";
15    cin >> score1 >> score2 >> score3;
16
17    // Calculate and display the average score.
18    average = (score1 + score2 + score3) / 3.0;
19    cout << fixed << showpoint << setprecision(1);
20    cout << "Your average is " << average << endl;
21
22    // ERROR! This if statement is missing its braces!
23    if (average > HIGH_SCORE)
24        cout << "Congratulations!\n";
25        cout << "That's a high score.\n";
26        cout << "You deserve a pat on the back!\n";
27    return 0;
28 }
```

### Program Output with Example Input Shown in Bold

```
Enter 3 test scores and I will average them: 80 90 70 Enter
Your average is 80
That's a high score.
You deserve a pat on the back!
```

The `cout` statements in lines 25 and 26 are always executed, even when `average` is not greater than 95. Because the braces have been removed, the `if` statement only controls execution of line 24. This is illustrated in [Figure 4-5](#).

**Figure 4-5** Conditionally executed statement



## Checkpoint

4.10 Write an `if` statement that performs the following logic: if the variable `sales` is greater than 50,000, then assign 0.25 to the `commissionRate` variable, and assign 250 to the `bonus` variable.

4.11 The following code segment is syntactically correct, but it appears to contain a logic error. Can you find the error?

```
if (interestRate > .07)
    cout << "This account earns a $10 bonus.\n";
    balance += 10.0;
```

## 4.4 The `if/else` Statement

### Concept:


The `if/else` statement will execute one group of statements if the expression is true, or another group of statements if the expression is false.

The `if/else` statement is an expansion of the `if` statement. Here is its format:

```
if (expression)
    statement or block
else
    statement or block
```



## The `if/else` Statement

As with the `if` statement, an expression is evaluated. If the expression is true, a statement or block of statements is executed. If the expression is false, however, a separate group of statements is executed. **Program 4-8**  uses the `if/else` statement along with the modulus operator to determine if a number is odd or even.

## Program 4-8

```
1 // This program uses the modulus operator to
determine
2 // if a number is odd or even. If the number
is evenly divisible
3 // by 2, it is an even number. A remainder
indicates it is odd.
4 #include <iostream>
5 using namespace std;
6
7 int main()
8 {
9     int number;
10
11     cout << "Enter an integer and I will tell
you if it\n";
12     cout << "is odd or even. ";
13     cin >> number;
14     if (number % 2 == 0)
15         cout << number << " is even.\n";
16     else
17         cout << number << " is odd.\n";
```

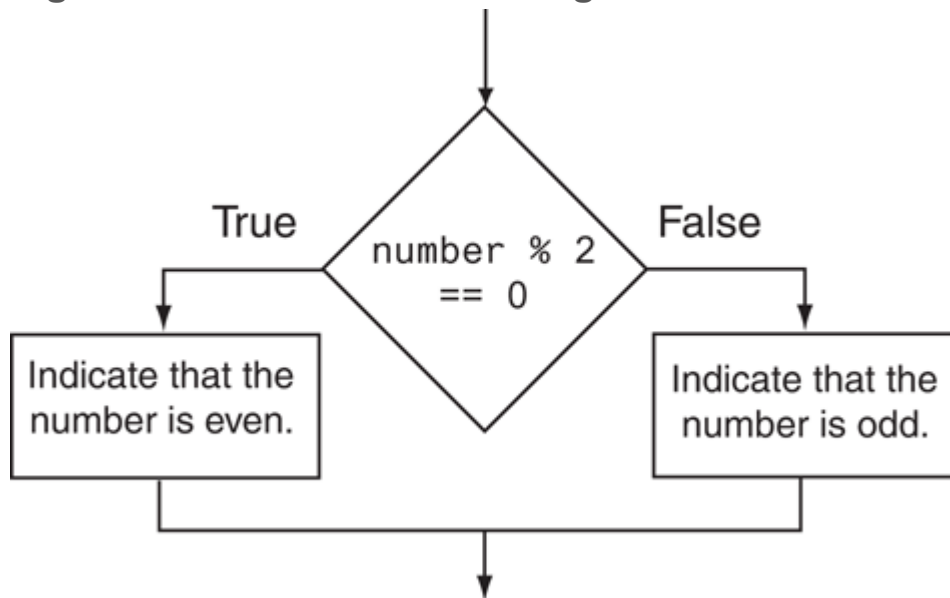
```
18     return 0;
19 }
```

### Program Output with Example Input Shown in Bold


```
Enter an integer and I will tell you if it
is odd or even. 17 Enter
17 is odd.
```

The `else` part at the end of the `if` statement specifies a statement that is to be executed when the expression is false. When `number % 2` does not equal 0, a message is printed indicating the number is odd. Note the program will only take one of the two paths in the `if/else` statement. If you think of the statements in a computer program as steps taken down a road, consider the `if/else` statement as a fork in the road. Instead of being a momentary detour, like an `if` statement, the `if/else` statement causes program execution to follow one of two exclusive paths. The flowchart in [Figure 4-6](#) shows the logic of this `if/else` statement.

**Figure 4-6 if/else statement logic**




Notice the programming style used to construct the `if/else` statement. The word `else` is at the same level of indentation as `if`. The statement whose execution is controlled by `else` is indented one level. This visually depicts the two paths of execution that may be followed.

Like the `if` part, the `else` part controls a single statement. If you wish to control more than one statement with the `else` part, create a block by writing the lines inside a set of braces. [Program 4-9](#)  shows this as a way of handling a classic programming problem: *division by zero*.

Division by zero is mathematically impossible to perform, and it normally causes a program to crash. This means the program will prematurely stop running, sometimes with an error message.



**Program 4-9**  shows a way to test the value of a divisor before the division takes place.

## Program 4-9

```
1 // This program asks the user for two numbers,  
num1 and num2.  
2 // num1 is divided by num2 and the result is  
displayed.  
3 // Before the division operation, however,  
num2 is tested  
4 // for the value 0. If it contains 0, the  
division does not  
5 // take place.  
6 #include <iostream>  
7 using namespace std;  
8  
9 int main()  
10 {  
11     double num1, num2, quotient;  
12  
13     // Get the first number.  
14     cout << "Enter a number: ";  
15     cin >> num1;  
16  
17     // Get the second number.  
18     cout << "Enter another number: ";  
19     cin >> num2;
```

```
20
21     // If num2 is not zero, perform the
division.
22     if (num2 == 0)
23     {
24         cout << "Division by zero is not
possible.\n";
25         cout << "Please run the program again
and enter\n";
26         cout << "a number other than zero.\n";
27     }
28     else
29     {
30         quotient = num1 / num2;
31         cout << "The quotient of " << num1 << "
divided by ";
32         cout << num2 << " is " << quotient <<
".\n";
33     }
34     return 0;
35 }
```

**Program Output with Example Input Shown in Bold**

```
Enter a number: 10 Enter
Enter another number: 0 Enter
Division by zero is not possible.
Please run the program again and enter
a number other than zero.
```

The value of `num2` is tested in line 22 before the division is performed. If the user enters 0, the lines controlled by the `if` part execute, displaying a message that indicates that the program cannot perform a division by zero. Otherwise, the `else` part takes control, which divides `num1` by `num2` and displays the result.



4.12 True or false: The following `if/else` statements cause the same output to display.

A.

```
if (x > y)
    cout << "x is the greater.\n";
else
    cout << "x is not the greater.\n";
```

B.

```
if (y <= x)
    cout << "x is not the greater.\n";
else
    cout << "x is the greater.\n";
```

4.13 Write an `if/else` statement that assigns 1 to `x` if `y` is equal to 100. Otherwise, it should assign 0 to `x`.

4.14 Write an `if/else` statement that assigns 0.10 to `commissionRate` unless `sales` is greater than or equal to 50000.00, in which case it assigns 0.20 to `commissionRate`.

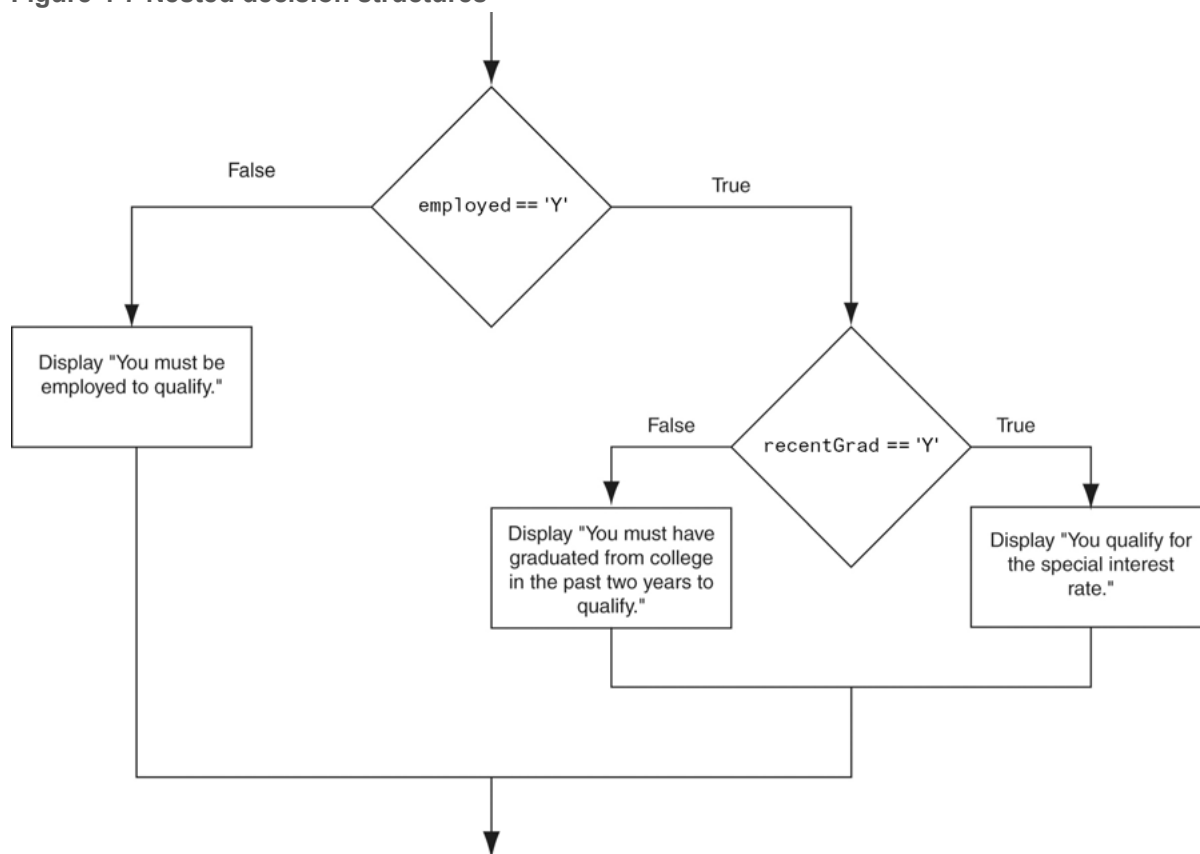
## 4.5 Nested `if` Statements


### Concept:

To test more than one condition, an `if` statement can be nested inside another `if` statement.

Sometimes an `if` statement must be nested inside another `if` statement. For example, consider a banking program that determines whether a bank customer qualifies for a special, low interest rate on a loan. To qualify, two conditions must exist: (1) the customer must be currently employed, and (2) the customer must have recently graduated from college (in the past 2 years). [Figure 4-7](#) shows a flowchart for an algorithm that could be used in such a program.

**Figure 4-7** Nested decision structures



If we follow the flow of execution in the flowchart, we see that the expression `employed == 'Y'` is tested. If this expression is false, there is no need to perform further tests; we know that the customer does not qualify for the special interest rate. If the expression is true, however, we need to test the second condition. This is done with a nested decision structure that tests the expression `recentGrad == 'Y'`. If this expression is true, then the customer qualifies for the special interest rate. If this expression is false, then the customer does not qualify. [Program 4-10](#)  shows the code for the complete program.

## Program 4-10

```
1 // This program demonstrates the nested if statement.
2 #include <iostream>
3 using namespace std;
4
5 int main()
6 {
7     char employed, // Currently employed, Y or N
8         recentGrad; // Recent graduate, Y or N
9
10    // Is the user employed and a recent graduate?
11    cout << "Answer the following questions\n";
12    cout << "with either Y for Yes or ";
13    cout << "N for No.\n";
14    cout << "Are you employed? ";
15    cin >> employed;
16    cout << "Have you graduated from college ";
17    cout << "in the past two years? ";
18    cin >> recentGrad;
19
20    // Determine the user's loan qualifications.
21    if (employed == 'Y')
22    {
23        if (recentGrad == 'Y') //Nested if
24        {
25            cout << "You qualify for the special ";
26            cout << "interest rate.\n";
27        }
28    }
29    return 0;
30 }
```

**Program Output with Example Input Shown in Bold**



```
Answer the following questions
with either Y for Yes or N for No.
Are you employed? Y Enter
Have you graduated from college in the past two years? Y Enter
You qualify for the special interest rate.
```

### Program Output with Different Example Input Shown in Bold

```
Answer the following questions
with either Y for Yes or N for No.
Are you employed? Y Enter
Have you graduated from college in the past two years? N Enter
```

Look at the `if` statement that begins in line 21. It tests the expression `employed == 'Y'`. If this expression is true, the `if` statement that begins in line 23 is executed. Otherwise, the program jumps to the `return` statement in line 29 and the program ends.

Notice in the second sample execution of [Program 4-10](#) that the program output does not inform the user whether he or she qualifies for the special interest rate. If the user enters an 'N' (or any character other than 'Y') for `employed` or `recentGrad`, the program does not print a message letting the user know that he or she does not qualify. An `else` statement should be able to remedy this, as illustrated by [Program 4-11](#).

## Program 4-11

```
1 // This program demonstrates the nested if statement.
2 #include <iostream>
3 using namespace std;
4
5 int main()
6 {
7     char employed, // Currently employed, Y or N
8         recentGrad; // Recent graduate, Y or N
9
10    // Is the user employed and a recent graduate?
11    cout << "Answer the following questions\n";
12    cout << "with either Y for Yes or ";
13    cout << "N for No.\n";
14    cout << "Are you employed? ";
15    cin >> employed;
16    cout << "Have you graduated from college ";
17    cout << "in the past two years? ";
18    cin >> recentGrad;
19
20    // Determine the user's loan qualifications.
21    if (employed == 'Y')
22    {
23        if (recentGrad == 'Y') // Nested if
24        {
25            cout << "You qualify for the special ";
26            cout << "interest rate.\n";
27        }
28        else // Not a recent grad, but employed
29        {
30            cout << "You must have graduated from ";
31            cout << "college in the past two\n";
32            cout << "years to qualify.\n";
33        }
34    }
35    else // Not employed
36    {
37        cout << "You must be employed to qualify.\n";
```

```
38     }  
39     return 0;  
40 }
```

### Program Output with Example Input Shown in Bold

```
Answer the following questions  
with either Y for Yes or N for No.  
Are you employed? N Enter  
Have you graduated from college in the past two years? Y Enter  
You must be employed to qualify.
```

### Program Output with Different Example Input Shown in Bold

```
Answer the following questions  
with either Y for Yes or N for No.  
Are you employed? Y Enter  
Have you graduated from college in the past two years? N Enter  
You must have graduated from college in the past two years to qualify.
```

### Program Output with Different Example Input Shown in Bold

```
Answer the following questions  
with either Y for Yes or N for No.  
Are you employed? Y Enter  
Have you graduated from college in the past two years? Y Enter  
You qualify for the special interest rate.
```

In this version of the program, both `if` statements have `else` clauses that inform the user why he or she does not qualify for the special interest rate.

# Programming Style and Nested Decision Structures

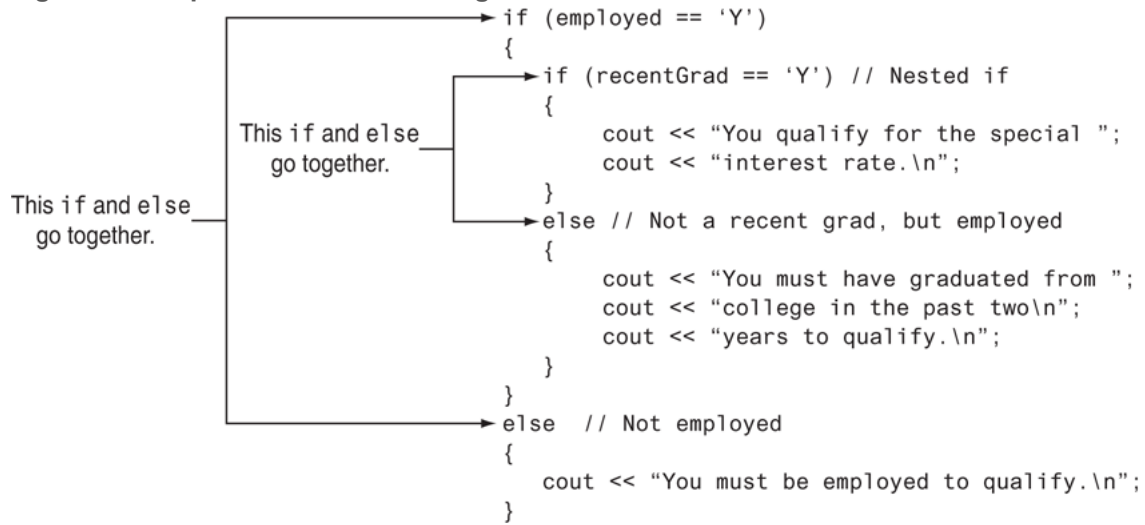
For readability and easier debugging, it's important to use proper alignment and indentation in a set of nested `if` statements. This makes it easier to see which actions are performed by each part of the decision structure. For example, the following code is functionally equivalent to lines 21 through 38 in [Program 4-11](#). Although this code is logically correct, it is very difficult to read, and would be very difficult to debug because it is not properly indented.

```
if (employed == 'Y')
{
if (recentGrad == 'Y') // Nested if
{
cout << "You qualify for the special ";
cout << "interest rate.\n";
}
else // Not a recent grad, but employed
{
cout << "You must have graduated from ";
cout << "college in the past two\n";
cout << "years to qualify.\n";
}
}
else // Not employed
{
cout << "You must be employed to qualify.\n";
}
```

*Don't write code like this!*

Proper indentation and alignment also makes it easier to see which `if` and `else` clauses belong together, as shown in [Figure 4-8](#).

Figure 4-8 Proper indentation and alignment



# Testing a Series of Conditions

In the previous example, you saw how a program can use nested decision structures to test more than one condition. It is not uncommon for a program to have a series of conditions to test then perform an action depending on which condition is true. One way to accomplish this is to have a decision structure with numerous other decision structures nested inside it. For example, consider the program presented in the following *In the Spotlight* section.



## In the Spotlight:

### Multiple Nested Decision Structures

Dr. Suarez teaches a literature class and uses the following 10-point grading scale for all of his exams:

He has asked you to write a program that will allow a student to enter a test score and then display the grade for that score. Here is the algorithm that you will use:

```
Ask the user to enter a test score.
```

```
Determine the grade in the following manner:
```

```
If the score is greater than or equal to 90, then the grade is A.
```

```
    Otherwise, if the score is greater than or equal to 80, then the grade is B.
```

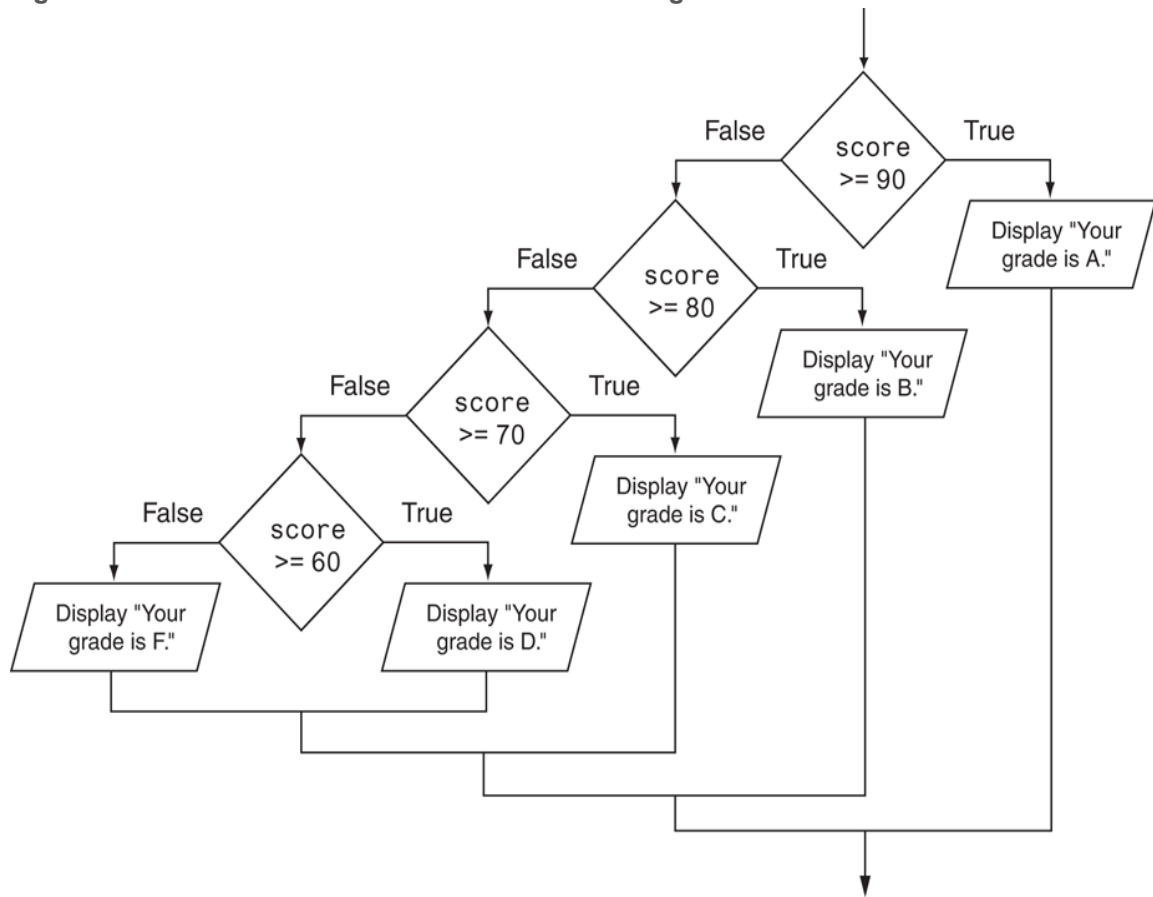
```
        Otherwise, if the score is greater than or equal to 70, then the grade is C.
```

```
            Otherwise, if the score is greater than or equal to 60, then the grade is D.
```

```
                Otherwise, the grade is F.
```

You decide that the process of determining the grade will require several nested decision structures, as shown in [Figure 4-9](#). [Program 4-12](#) shows the code for the complete program. The code for the nested decision structures is in lines 17 through 45.

Figure 4-9 Nested decision structure to determine a grade





## Program 4-12

```
1 // This program uses nested if/else statements to assign a
2 // letter grade (A, B, C, D, or F) to a numeric test score.
3 #include <iostream>
4 using namespace std;
5
6 int main()
7 {
8     // Constants for grade thresholds
9     const int A_SCORE = 90,
10             B_SCORE = 80,
11             C_SCORE = 70,
12             D_SCORE = 60;
13
14     int testScore; // To hold a numeric test score
15
16     // Get the numeric test score.
17     cout << "Enter your numeric test score and I will\n";
18     cout << "tell you the letter grade you earned: ";
19     cin >> testScore;
20
21     // Determine the letter grade.
22     if (testScore >= A_SCORE)
23     {
24         cout << "Your grade is A.\n";
25     }
26     else
27     {
28         if (testScore >= B_SCORE)
29         {
30             cout << "Your grade is B.\n";
31         }
32         else
33         {
34             if (testScore >= C_SCORE)
35             {
36                 cout << "Your grade is C.\n";
```

```
37     }
38     else
39     {
40         if (testScore >= D_SCORE)
41         {
42             cout << "Your grade is D.\n";
43         }
44     else
45     {
46         cout << "Your grade is F.\n";
47     }
48     }
49     }
50     }
51
52     return 0;
53 }
```

#### Program Output with Example Input Shown in Bold

```
Enter your numeric test score and I will
tell you the letter grade you earned: 78 Enter
Your grade is C.
```

#### Program Output with Different Example Input Shown in Bold

```
Enter your numeric test score and I will
tell you the letter grade you earned: 84 Enter
Your grade is B.
```

 **Checkpoint**

4.15 If you executed the following code, what would it display if the user enters 5? What if the user enters 15? What if the user enters 30? What if the user enters -1?

```
int number;
cout << "Enter a number: ";
cin >> number;
if (number > 0)
{
    cout << "Zero\n";
    if (number > 10)
    {
        cout << "Ten\n";
        if (number > 20)
        {
            cout << "Twenty\n";
        }
    }
}
```

## 4.6 The `if/else if` Statement

### Concept:

The `if/else if` statement tests a series of conditions. It is often simpler to test a series of conditions with the `if/else if` statement than with a set of nested `if/else` statements.

Even though [Program 4-12](#) is a simple example, the logic of the nested decision structure is fairly complex. In C++, and many other languages, you can alternatively test a series of conditions using the `if/else if` statement. The `if/else if` statement makes certain types of nested decision logic simpler to write. Here is the general format of the `if/else if` statement:



### The `if/else if` Statement

```

if (expression_1)
{
    statement
    statement
    etc.
}
else if (expression_2)
{
    statement
    statement
    etc.
}
Insert as many else if clauses as necessary
else
{
    statement
    statement
    etc.
}

```

*If expression\_1 is true these statements are executed, and the rest of the structure is ignored.*

*Otherwise, if expression\_2 is true these statements are executed, and the rest of the structure is ignored.*

*These statements are executed if none of the expressions above are true.*



When the statement executes, `expression_1` is tested. If `expression_1` is true, the block of statements that immediately follows is executed, and the rest of the structure is ignored. If `expression_1` is false, however, the program jumps to the very next `else if` clause and tests `expression_2`. If it is true, the block of statements that immediately follows is executed, and then the rest of the structure is ignored. This process continues, from the top of the structure to the bottom, until one of the expressions is found to be true. If none of the expressions are true, the last `else` clause takes over, and the block of statements immediately following it is executed.

The last `else` clause, which does not have an `if` statement following it, is referred to as the *trailing else*. The trailing `else` is optional, but in most cases you will use it.



### Note:

The general format shows braces surrounding each block of conditionally executed statements. As with other forms of the `if` statement, the braces are required only when more than one statement is conditionally executed.

**Program 4-13**  shows an example of the `if/else if` statement. This program is a modification of **Program 4-12** , which appears in the previous *In the Spotlight* section.

## Program 4-13

```
1 // This program uses an if/else if statement to assign a
2 // letter grade (A, B, C, D, or F) to a numeric test score.
3 #include <iostream>
4 using namespace std;
5
6 int main()
7 {
8     // Constants for grade thresholds
9     const int A_SCORE = 90,
10             B_SCORE = 80,
11             C_SCORE = 70,
12             D_SCORE = 60;
13
14     int testScore; // To hold a numeric test score
15
16     // Get the numeric test score.
17     cout << "Enter your numeric test score and I will\n"
18          << "tell you the letter grade you earned: ";
19     cin >> testScore;
20
21     // Determine the letter grade.
22     if (testScore >= A_SCORE)
23         cout << "Your grade is A.\n";
24     else if (testScore >= B_SCORE)
25         cout << "Your grade is B.\n";
26     else if (testScore >= C_SCORE)
27         cout << "Your grade is C.\n";
28     else if (testScore >= D_SCORE)
29         cout << "Your grade is D.\n";
30     else
31         cout << "Your grade is F.\n";
32
33     return 0;
34 }
```

**Program Output with Example Input Shown in Bold**

```
Enter your numeric test score and I will  
tell you the letter grade you earned: 78 Enter  
Your grade is C.
```

### Program Output with Different Example Input Shown in Bold

```
Enter your numeric test score and I will  
tell you the letter grade you earned: 84 Enter  
Your grade is B.
```

Let's analyze how the `if/else if` statement in lines 22 through 31 works. First, the expression `testScore >= A_SCORE` is tested in line 22:

```
→ if (testScore >= A_SCORE)  
    cout << "Your grade is A.\n";  
else if (testScore >= B_SCORE)  
    cout << "Your grade is B.\n";  
else if (testScore >= C_SCORE)  
    cout << "Your grade is C.\n";  
else if (testScore >= D_SCORE)  
    cout << "Your grade is D.\n";  
else  
    cout << "Your grade is F.\n";
```

If `testScore` is greater than or equal to 90, the string `"Your grade is A.\n"` is displayed and the rest of the `if/else if` statement is skipped. If `testScore` is not greater than or equal to 90, the `else` clause in line 24 takes over and causes the next `if` statement to be executed:

```
if (testScore >= A_SCORE)
    cout << "Your grade is A.\n";
→ else if (testScore >= B_SCORE)
    cout << "Your grade is B.\n";
    else if (testScore >= C_SCORE)
        cout << "Your grade is C.\n";
    else if (testScore >= D_SCORE)
        cout << "Your grade is D.\n";
    else
        cout << "Your grade is F.\n";
```

The first `if` statement handles all of the grades greater than or equal to 90, so when this `if` statement executes, `testScore` will have a value of 89 or less. If `testScore` is greater than or equal to 80, the string `"Your grade is B.\n"` is displayed and the rest of the `if/else if` statement is skipped. This chain of events continues until one of the expressions is found to be true, or the last `else` clause at the end of the statement is encountered.

Notice the alignment and indentation that is used with the `if/else if` statement: The starting `if` clause, the `else if` clauses, and the trailing `else` clause are all aligned, and the conditionally executed statements are indented.



## Using the Trailing `else` to Catch Errors

The trailing `else` clause, which appears at the end of the `if/else if` statement, is optional, but in many situations you will use it to catch errors. For example, [Program 4-13](#) will assign a grade to any number that is entered as the test score, including negative numbers. If a negative test score is entered, however, the user has probably made a mistake. We can modify the code as shown in [Program 4-14](#) so the trailing `else` clause catches any test score that is less than 0 and displays an error message.

## Program 4-14

```
1 // This program uses an if/else if statement to assign a
2 // letter grade (A, B, C, D, or F) to a numeric test score.
3 #include <iostream>
4 using namespace std;
5
6 int main()
7 {
8     // Constants for grade thresholds
9     const int A_SCORE = 90,
10            B_SCORE = 80,
11            C_SCORE = 70,
12            D_SCORE = 60;
13
14     int testScore; // To hold a numeric test score
15
16     // Get the numeric test score.
17     cout << "Enter your numeric test score and I will\n"
18          << "tell you the letter grade you earned: ";
19     cin >> testScore;
20
21     // Determine the letter grade.
22     if (testScore >= A_SCORE)
23         cout << "Your grade is A.\n";
24     else if (testScore >= B_SCORE)
25         cout << "Your grade is B.\n";
26     else if (testScore >= C_SCORE)
27         cout << "Your grade is C.\n";
28     else if (testScore >= D_SCORE)
29         cout << "Your grade is D.\n";
30     else if (testScore >= 0)
31         cout << "Your grade is F.\n";
32     else
33         cout << "Invalid test score.\n";
34
35     return 0;
36 }
```

### Program Output with Example Input Shown in Bold

```
Enter your numeric test score and I will  
tell you the letter grade you earned: -1 Enter  
Invalid test score.
```

# The `if/else if` Statement Compared to a Nested Decision Structure

You never have to use the `if/else if` statement because its logic can be coded with nested `if/else` statements. However, a long series of nested `if/else` statements has two particular disadvantages when you are debugging code:

- The code can grow complex and become difficult to understand.
- Because indenting is important in nested statements, a long series of nested `if/else` statements can become too long to be displayed on the computer screen without horizontal scrolling. Also, long statements tend to “wrap around” when printed on paper, making the code even more difficult to read.

The logic of an `if/else if` statement is usually easier to follow than that of a long series of nested `if/else` statements. And, because all of the clauses are aligned in an `if/else if` statement, the lengths of the lines in the statement tend to be shorter.



#### 4.16 What will the following code display?

```
int funny = 7, serious = 15;
funny = serious % 2;
if (funny != 1)
{
    funny = 0;
    serious = 0;
}
else if (funny == 2)
{
    funny = 10;
    serious = 10;
}
else
{
    funny = 1;
    serious = 1;
}
cout << funny << " " << serious << endl;
```

#### 4.17 The following code is used in a bookstore program to determine how many discount coupons a customer gets. Complete the table that appears after the program.

```
int numBooks, numCoupons;
cout << "How many books are being purchased? ";
cin >> numBooks;
if (numBooks < 1)
    numCoupons = 0;
else if (numBooks < 3)
    numCoupons = 1;
else if (numBooks < 5)
    numCoupons = 2;
else
    numCoupons = 3;
cout << "The number of coupons to give is "
    << numCoupons << endl;
```

## 4.7 Flags

### Concept:

A flag is a Boolean or integer variable that signals when a condition exists.

A *flag* is typically a `bool` variable that signals when some condition exists in the program. When the flag variable is set to `false`, it indicates that the condition does not exist. When the flag variable is set to `true`, it means the condition does exist.

For example, suppose a program that calculates sales commissions has a `bool` variable, defined and initialized as shown here:

```
bool salesQuotaMet = false;
```

In the program, the `salesQuotaMet` variable is used as a flag to indicate whether a salesperson has met the sales quota. When we define the variable, we initialize it with `false` because we do not yet know if the salesperson has met the sales quota. Assuming a

variable named `sales` holds the amount of sales, code similar to the following might be used to set the value of the `salesQuotaMet` variable:

```
if (sales >= QUOTA_AMOUNT)
    salesQuotaMet = true;
else
    salesQuotaMet = false;
```

As a result of this code, the `salesQuotaMet` variable can be used as a flag to indicate whether the sales quota has been met. Later in the program, we might test the flag in the following way:

```
if (salesQuotaMet)
    cout << "You have met your sales quota!\n";
```

This code displays *You have met your sales quota!* if the `bool` variable `salesQuotaMet` is `true`. Notice we did not have to use the `==` operator to explicitly compare the `salesQuotaMet` variable with the value `true`. This code is equivalent to the following:

```
if (salesQuotaMet == true)
    cout << "You have met your sales quota!\n";
```

# Integer Flags

Integer variables may also be used as flags. This is because in C++ the value 0 is considered false, and any nonzero value is considered true. In the sales commission program previously described, we could define the `salesQuotaMet` variable with the following statement:

```
int salesQuotaMet = 0; // 0 means false.
```

As before, we initialize the variable with 0 because we do not yet know if the sales quota has been met. After the sales have been calculated, we can use code similar to the following to set the value of the `salesQuotaMet` variable:

```
if (sales >= QUOTA_AMOUNT)
    salesQuotaMet = 1;
else
    salesQuotaMet = 0;
```

Later in the program, we might test the flag in the following way:



```
if (salesQuotaMet)
```

```
    cout << "You have met your sales quota!\n";
```

## 4.8 Logical Operators

### Concept:

Logical operators connect two or more relational expressions into one or reverse the logic of an expression.

In the previous section, you saw how a program tests two conditions with two `if` statements. In this section, you will see how to use logical operators to combine two or more relational expressions into one. [Table 4-6](#) lists C++'s logical operators.

### Table 4-6 Logical Operators

# The `&&` Operator

The `&&` operator is known as the logical AND operator. It takes two expressions as operands and creates an expression that is true only when both subexpressions are true. Here is an example of an `if` statement that uses the `&&` operator:

```
if (temperature < 20 && minutes > 12)
    cout << "The temperature is in the danger zone.";
```

In the statement above, the two relational expressions are combined into a single expression. The `cout` statement will only be executed if `temperature` is less than 20 AND `minutes` is greater than 12. If either relational test is false, the entire expression is false, and the `cout` statement is not executed.


 **Tip:**

You must provide complete expressions on both sides of the `&&` operator. For example, the following statement is not correct because the condition on the right side of the `&&` operator is not a complete expression:

```
temperature > 0 && < 100
```

The expression must be rewritten as

```
temperature > 0 && temperature < 100
```

**Table 4-7**  shows a truth table for the `&&` operator. The truth table lists all the possible combinations of values that two expressions may have, and the resulting value returned by the `&&` operator connecting the two expressions.

#### **Table 4-7 Truth Table for the `&&` Operator**

As the table shows, both subexpressions must be true for the `&&` operator to return a true value.



### **Note:**

If the subexpression on the left side of an `&&` operator is false, the expression on the right side will not be checked. Since the entire expression is false if only one of the subexpressions is false, it would waste CPU time to check the remaining expression. This is called *short-circuit evaluation*.

The `&&` operator can be used to simplify programs that otherwise would use nested `if` statements. [Program 4-15](#) performs a similar operation as [Program 4-11](#), which qualifies a bank customer for a special interest rate. This program uses a logical operator.

## Program 4-15

```
1 // This program demonstrates the && logical
operator.
2 #include <iostream>
3 using namespace std;
4
5 int main()
6 {
7     char employed, // Currently employed, Y
or N
8     recentGrad; // Recent graduate, Y or
N
9
10    // Is the user employed and a recent
graduate?
11    cout << "Answer the following
questions\n";
12    cout << "with either Y for Yes or N for
No.\n";
13
14    cout << "Are you employed? ";
15    cin >> employed;
16
17    cout << "Have you graduated from college "
```

```
18         << "in the past two years? ";
19         cin >> recentGrad;
20
21         // Determine the user's loan
qualifications.
22         if (employed == 'Y' && recentGrad == 'Y')
23         {
24             cout << "You qualify for the special "
25                 << "interest rate.\n";
26         }
27         else
28         {
29             cout << "You must be employed and
have\n"
30                 << "graduated from college in
the\n"
31                 << "past two years to qualify.\n";
32         }
33         return 0;
34     }
```

**Program Output with Example Input Shown in Bold**

```
Answer the following questions
with either Y for Yes or N for No.
Are you employed? Y Enter
Have you graduated from college in the past
two years? N Enter
You must be employed and have
graduated from college in the
past two years to qualify.
```

### Program Output with Example Input Shown in Bold

```
Answer the following questions
with either Y for Yes or N for No.
Are you employed? N Enter
Have you graduated from college in the past
two years? Y Enter
You must be employed and have
graduated from college in the
past two years to qualify.
```

### Program Output with Example Input Shown in Bold



```
Answer the following questions
with either Y for Yes or N for No.
Are you employed? Y Enter
Have you graduated from college in the past
two years? Y Enter
You qualify for the special interest rate.
```

The message `"You qualify for the special interest rate."` is displayed only when both the expressions `employed == 'Y'` and `recentGrad == 'Y'` are true. If either of these is false, the message `"You must be employed and have graduated from college in the past two years to qualify."` is printed.



### **Note:**

Although it is similar, [Program 4-15](#) is not the logical equivalent of [Program 4-11](#). For example, [Program 4-15](#) doesn't display the message "You must be employed to qualify."

# The `||` Operator

The `||` operator is known as the logical OR operator. It takes two expressions as operands and creates an expression that is true when either of the subexpressions are true. Here is an example of an `if` statement that uses the `||` operator:

```
if (temperature < 20 || temperature > 100)
    cout << "The temperature is in the danger zone.";
```

The `cout` statement will be executed if `temperature` is less than 20 OR `temperature` is greater than 100. If either relational test is true, the entire expression is true and the `cout` statement is executed.



**Tip:**

You must provide complete expressions on both sides of the `||` operator. For example, the following code is not correct because the condition on the right side of the `||` operator is not a complete expression:

```
temperature < 0 || > 100
```

The expression must be rewritten as

```
temperature < 0 || temperature > 100
```

**Table 4-8**  shows a truth table for the `||` operator.


#### **Table 4-8 Truth Table for the `||` Operator**

All it takes for an OR expression to be true is for one of the subexpressions to be true. It doesn't matter if the other subexpression is false or true.



### **Note:**

The `||` operator also performs short-circuit evaluation. If the subexpression on the left side of an `||` operator is true, the expression on the right side will not be checked. Since it's only necessary for one of the subexpressions to be true, it would waste CPU time to check the remaining expression.

**Program 4-16**  performs different tests to qualify a person for a loan. This one determines if the customer earns at least \$35,000 per year, or has been employed for more than 5 years.

## Program 4-16

```
1 // This program demonstrates the logical ||
operator.
2 #include <iostream>
3 using namespace std;
4
5 int main()
6 {
7     // Constants for minimum income and years
8     const double MIN_INCOME = 35000.0;
9     const int MIN_YEARS = 5;
10
11     double income; // Annual income
12     int years;    // Years at the current
job
13
14     // Get the annual income
15     cout << "What is your annual income? ";
16     cin >> income;
17
18     // Get the number of years at the current
job.
19     cout << "How many years have you worked at
"
```

```

20         << "your current job? ";
21         cin >> years;
22
23         // Determine the user's loan
qualifications.
24         if (income >= MIN_INCOME || years >
MIN_YEARS)
25             cout << "You qualify.\n";
26         else
27             {
28                 cout << "You must earn at least $"
29                     << MIN_INCOME << " or have been "
30                     << "employed more than " <<
MIN_YEARS
31                     << " years.\n";
32             }
33         return 0;
34     }

```

## Program Output with Example Input Shown in Bold

```

What is your annual income? 40000 Enter
How many years have you worked at your
current job? 2 Enter
You qualify.

```

## Program Output with Example Input Shown in Bold

```
What is your annual income? 20000 Enter  
How many years have you worked at your  
current job? 7 Enter  
You qualify.
```

## Program Output with Example Input Shown in Bold

```
What is your annual income? 30000 Enter  
How many years have you worked at your  
current job? 3 Enter  
You must earn at least $35000 or have been  
employed more than 5 years.
```


The string `"You qualify\n."` is displayed when either or both the expressions `income >= 35000` or `years > 5` are true. If both of these are false, the disqualifying message is printed.

# The `!` Operator



The `!` operator performs a logical NOT operation. It takes an operand and reverses its truth or falsehood. In other words, if the expression is true, the `!` operator returns false, and if the expression is false, it returns true. Here is an `if` statement using the `!` operator:

```
if (!(temperature > 100))  
    cout << "You are below the maximum temperature.\n";
```

First, the expression `(temperature > 100)` is tested to be true or false. Then the `!` operator is applied to that value. If the expression `(temperature > 100)` is true, the `!` operator returns false. If it is false, the `!` operator returns true. In the example, it is equivalent to asking “is the temperature not greater than 100?”

**Table 4-9**  shows a truth table for the `!` operator.

## Table 4-9 Truth Table for the `!` Operator

**Program 4-17**  performs the same task as **Program 4-16** . The `if` statement, however, uses the `!` operator to determine if the user does *not* make at least \$35,000, or has *not* been on the job more than 5 years.




## Program 4-17

```
1 // This program demonstrates the logical !
operator.
2 #include <iostream>
3 using namespace std;
4
5 int main()
6 {
7     // Constants for minimum income and years
8     const double MIN_INCOME = 35000.0;
9     const int MIN_YEARS = 5;
10
11     double income; // Annual income
12     int years;    // Years at the current job
13
14     // Get the annual income
15     cout << "What is your annual income? ";
16     cin >> income;
17
18     // Get the number of years at the current
job.
19     cout << "How many years have you worked at
"
20     << "your current job? ";
```

```
21     cin >> years;
22
23     // Determine the user's loan
qualifications.
24     if (!(income >= MIN_INCOME || years >
MIN_YEARS))
25     {
26         cout << "You must earn at least $"
27             << MIN_INCOME << " or have been "
28             << "employed more than " <<
MIN_YEARS
29             << " years.\n";
30     }
31     else
32         cout << "You qualify.\n";
33     return 0;
34 }
```

The output of [Program 4-17](#) is the same as [Program 4-16](#).

# Precedence and Associativity of Logical Operators

**Table 4-10**  shows the precedence of C++'s logical operators, from highest to lowest.

## Table 4-10 Precedence of Logical Operators

The `!` operator has a higher precedence than many of the C++ operators. To avoid an error, you should always enclose its operand in parentheses unless you intend to apply it to a variable or a simple expression with no other operators. For example, consider the following expressions:

```
!(x > 2)
```

```
!x > 2
```

The first expression applies the `!` operator to the expression `x > 2`. It is asking, “is `x` not greater than 2?” The second expression, however, applies the `!` operator to `x` only. It is asking, “is the logical negation of `x` greater than 2?” Suppose `x` is set to 5. Since 5 is nonzero, it would be considered true, so the `!` operator would reverse it to false, which is 0. The `>` operator would then determine

if 0 is greater than 2. To avoid a catastrophe like this, always use parentheses!

The `&&` and `||` operators rank lower in precedence than the relational operators, so precedence problems are less likely to occur. If you feel unsure, however, it doesn't hurt to use parentheses anyway.

```
(a > b) && (x < y) is the same as a > b && x < y  
(x == y) || (b > a) is the same as x == y || b > a
```

The logical operators have left-to-right associativity. In the following expression, `a < b` is evaluated before `y == z`.

```
a < b || y == z
```

In the following expression, `y == z` is evaluated first, however, because the `&&` operator has higher precedence than `||`.

```
a < b || y == z && m > j
```

The expression is equivalent to

```
(a < b) || ((y == z) && (m > j))
```

## 4.9 Checking Numeric Ranges with Logical Operators

### Concept:

Logical operators are effective for determining whether a number is in or out of a range.

When determining whether a number is inside a numeric range, it's best to use the `&&` operator. For example, the following `if` statement checks the value in `x` to determine whether it is in the range of 20 through 40:

```
if (x >= 20 && x <= 40)
    cout << x << " is in the acceptable range.\n";
```

The expression in the `if` statement will be true only when `x` is both greater than or equal to 20 AND less than or equal to 40. `x` must be within the range of 20 through 40 for this expression to be true.

When determining whether a number is outside a range, the `||` operator is best to use. The following statement determines whether `x` is outside the range of 20 to 40:

```
if (x < 20 || x > 40)
    cout << x << " is outside the acceptable range.\n";
```

It's important not to get the logic of these logical operators confused. For example, the following `if` statement would never test true:

```
if (x < 20 && x > 40)
    cout << x << " is outside the acceptable range.\n";
```

Obviously, `x` cannot be less than 20 and at the same time greater than 40.



## Note:

C++ does not allow you to check numeric ranges with expressions such as `5 < x < 20`. Instead, you must use a logical operator to connect two relational expressions, as previously discussed.



# Checkpoint

4.18 The following truth table shows various combinations of the values `true` and `false` connected by a logical operator.

Complete the table by indicating if the result of such a combination is True or False.

4.19 Assume the variables `a = 2`, `b = 4`, and `c = 6`.

Determine whether each of the following conditions is True or False:

- A. `a == 4 || b > 2`
- B. `6 <= c && a > 3`
- C. `1 != b && c != 3`
- D. `a >= -1 || a <= b`
- E. `!(a > 2)`

4.20 Write an `if` statement that prints the message “The number is valid” if the variable `speed` is within the range 0 through 200.

4.21 Write an `if` statement that prints the message “The number is not valid” if the variable `speed` is outside the range 0 through 200.

## 4.10 Menus

### Concept:


You can use nested `if/else` statements or the `if/else if` statement to create menu-driven programs. A *menu-driven* program allows the user to determine the course of action by selecting it from a list of actions.

A menu is a screen displaying a set of choices from which the user selects. For example, a program that manages a mailing list might give you the following menu:

1. Add a name to the list.
2. Remove a name from the list.
3. Change a name in the list.
4. Print the list.
5. Quit the program.

The user selects one of the operations by entering its number. Entering 4, for example, causes the mailing list to be printed, and entering 5 causes the program to end. Nested `if/else` statements or an `if/else if` structure can be used to set up such a menu.

After the user enters a number, the program compares the number with the available selections and executes the statements that perform that operation.

**Program 4-18**  calculates the charges for membership in a health club. The club has three membership packages to choose from: standard adult membership, child membership, and senior citizen membership. The program presents a menu that allows the user to choose the desired package then calculates the cost of the membership.

## Program 4-18

```
1 // This program displays a menu and asks the
user to make a
2 // selection. An if/else if statement
determines which item
3 // the user has chosen.
4 #include <iostream>
5 #include <iomanip>
6 using namespace std;
7
8 int main()
9 {
10     int choice;    // To hold a menu choice
11     int months;   // To hold the number of
months
12     double charges; // To hold the monthly
charges
13
14     // Constants for membership rates
15     const double ADULT = 40.0,
16                 SENIOR = 30.0,
17                 CHILD = 20.0;
18
19     // Constants for menu choices
```

```
20     const int ADULT_CHOICE = 1,
21             CHILD_CHOICE = 2,
22             SENIOR_CHOICE = 3,
23             QUIT_CHOICE = 4;
24
25     // Display the menu and get a choice.
26     cout << "\t\tHealth Club Membership
Menu\n\n"
27           << "1. Standard Adult Membership\n"
28           << "2. Child Membership\n"
29           << "3. Senior Citizen Membership\n"
30           << "4. Quit the Program\n\n"
31           << "Enter your choice: ";
32     cin >> choice;
33
34     // Set the numeric output formatting.
35     cout << fixed << showpoint <<
setprecision(2);
36
37     // Respond to the user's menu selection.
38     if (choice == ADULT_CHOICE)
39     {
40         cout << "For how many months? ";
41         cin >> months;
42         charges = months * ADULT;
43         cout << "The total charges are $" <<
charges << endl;
```

```
44     }
45     else if (choice == CHILD_CHOICE)
46     {
47         cout << "For how many months? ";
48         cin >> months;
49         charges = months * CHILD;
50         cout << "The total charges are $" <<
charges << endl;
51     }
52     else if (choice == SENIOR_CHOICE)
53     {
54         cout << "For how many months? ";
55         cin >> months;
56         charges = months * SENIOR;
57         cout << "The total charges are $" <<
charges << endl;
58     }
59     else if (choice == QUIT_CHOICE)
60     {
61         cout << "Program ending.\n";
62     }
63     else
64     {
65         cout << "The valid choices are 1
through 4. Run the\n"
66         << "program again and select one
of those.\n";
```

```
67     }  
68     return 0;  
69 }
```

### Program Output with Example Input Shown in Bold

```
Health Club Membership Menu  
1. Standard Adult Membership  
2. Child Membership  
3. Senior Citizen Membership  
4. Quit the Program  
Enter your choice: 3 Enter  
For how many months? 6 Enter  
The total charges are $180.00
```

Let's take a closer look at the program:

- Lines 10–12 define the following variables:
  - The `choice` variable will hold the user's menu choice.
  - The `months` variable will hold the number of months of health club membership.
  - The `charges` variable will hold the total charges.
- Lines 15–17 define named constants for the monthly membership rates for adult, senior citizen, and child memberships.

- Lines 20–23 define named constants for the menu choices.
- Lines 26–32 display the menu and get the user’s choice.
- Line 35 sets the numeric output formatting for floating-point numbers.
- Lines 38–67 are an `if/else if` statement that determines the user’s menu choice in the following manner:
  - If the user selected 1 from the menu (adult membership), the statements in lines 40–43 are executed.
  - Otherwise, if the user selected 2 from the menu (child membership), the statements in lines 47–50 are executed.
  - Otherwise, if the user selected 3 from the menu (senior citizen membership), the statements in lines 54–57 are executed.
  - Otherwise, if the user selected 4 from the menu (quit the program), the statement in line 61 is executed.
  - If the user entered any choice other than 1, 2, 3, or 4, the `else` clause in lines 63–67 executes, displaying an error message.



# 4.11 Focus on Software Engineering: Validating User Input

## **Concept:**


As long as the user of a program enters bad input, the program will produce bad output. Programs should be written to filter out bad input.

Perhaps the most famous saying of the computer world is “Garbage in, garbage out.” The integrity of a program’s output is only as good as its input, so you should try to make sure garbage does not go into your programs. *Input validation* is the process of inspecting data given to a program by the user and determining if it is valid. A good program should give clear instructions about the kind of input that is acceptable, and not assume the user has followed those instructions. Here are just a few examples of input validations performed by programs:

- Numbers are checked to ensure they are within a range of possible values. For example, there are 168 hours in a week. It is

not possible for a person to be at work longer than 168 hours in one week.

- Values are checked for their “reasonableness.” Although it might be possible for a person to be at work for 168 hours per week, it is not probable.
- Items selected from a menu or other sets of choices are checked to ensure they are available options.
- Variables are checked for values that might cause problems, such as division by zero.

**Program 4-19**  is a test scoring program that rejects any test score less than 0 or greater than 100.

## Program 4-19

```
1 // This test scoring program does not accept
test scores
2 // that are less than 0 or greater than 100.
3 #include <iostream>
4 using namespace std;
5
6 int main()
7 {
8     // Constants for grade thresholds
9     const int A_SCORE = 90,
10            B_SCORE = 80,
11            C_SCORE = 70,
12            D_SCORE = 60,
13            MIN_SCORE = 0,    // Minimum
valid score
14            MAX_SCORE = 100; // Maximum
valid score
15
16     int testScore; // To hold a numeric test
score
17
18     // Get the numeric test score.
19     cout << "Enter your numeric test score and
```

```
I will\n"
20         << "tell you the letter grade you
earned: ";
21     cin >> testScore;
22
23     // Validate the input and determine the
grade.
24     if (testScore >= MIN_SCORE && testScore <=
MAX_SCORE)
25     {
26         // Determine the letter grade.
27         if (testScore >= A_SCORE)
28             cout << "Your grade is A.\n";
29         else if (testScore >= B_SCORE)
30             cout << "Your grade is B.\n";
31         else if (testScore >= C_SCORE)
32             cout << "Your grade is C.\n";
33         else if (testScore >= D_SCORE)
34             cout << "Your grade is D.\n";
35         else
36             cout << "Your grade is F.\n";
37     }
38     else
39     {
40         // An invalid score was entered.
41         cout << "That is an invalid score. Run
the program\n"
```

```
42         << "again and enter a value in
the range of\n"
43         << MIN_SCORE << " through " <<
MAX_SCORE << ".\n";
44     }
45
46     return 0;
47 }
```

### Program Output with Example Input Shown in Bold

```
Enter your numeric test score and I will
tell you the letter grade you earned: -1
Enter
That is an invalid score. Run the program
again and enter a value in the range of
0 through 100.
```

### Program Output with Example Input Shown in Bold

Enter your numeric test score and I will  
tell you the letter grade you earned: **81**

Enter

Your grade is B.

## 4.12 Comparing Characters and Strings

### **Concept:**

Relational operators can also be used to compare characters and `string` objects.

Earlier in this chapter, you learned to use relational operators to compare numeric values. They can also be used to compare characters and `string` objects.

# Comparing Characters

As you learned in [Chapter 3](#), characters are actually stored in memory as integers. On most systems, this integer is the ASCII value of the character. For example, the letter 'A' is represented by the number 65, the letter 'B' is represented by the number 66, and so on. [Table 4-11](#) shows the ASCII numbers that correspond to some of the commonly used characters.

## Table 4-11 ASCII Values of Commonly Used Characters

Notice every character, even the blank, has an ASCII code associated with it. Notice also that the ASCII code of a character representing a digit, such as `'1'` or `'2'`, is not the same as the value of the digit itself. A complete table showing the ASCII values for all characters can be found in [Appendix A](#).

When two characters are compared, it is actually their ASCII values that are being compared. `'A' < 'B'` because the ASCII value of `'A'` (65) is less than the ASCII value of `'B'` (66). Likewise `'1' < '2'` because the ASCII value of `'1'` (49) is less than the ASCII value of `'2'` (50). However, as shown in [Table 4-11](#), lowercase letters have higher ASCII codes than uppercase letters, so `'a' > 'z'`. [Program 4-20](#) shows how characters can be compared with relational operators.



## Program 4-20

```
1 // This program demonstrates how characters
can be
2 // compared with the relational operators.
3 #include <iostream>
4 using namespace std;
5
6 int main()
7 {
8     char ch;
9
10    // Get a character from the user.
11    cout << "Enter a digit or a letter: ";
12    ch = cin.get();
13
14    // Determine what the user entered.
15    if (ch >= '0' && ch <= '9')
16        cout << "You entered a digit.\n";
17    else if (ch >= 'A' && ch <= 'Z')
18        cout << "You entered an uppercase
letter.\n";
19    else if (ch >= 'a' && ch <= 'z')
20        cout << "You entered a lowercase
letter.\n";
```

```
21     else
22         cout << "That is not a digit or a
letter.\n";
23
24     return 0;
25 }
```

### Program Output with Example Input Shown in Bold

```
Enter a digit or a letter: t Enter
You entered a lowercase letter.
```

### Program Output with Example Input Shown in Bold

```
Enter a digit or a letter: v Enter
You entered an uppercase letter.
```

### Program Output with Example Input Shown in Bold

```
Enter a digit or a letter: 5 Enter
You entered a digit.
```

### Program Output with Example Input Shown in Bold

```
Enter a digit or a letter: & Enter  
That is not a digit or a letter.
```

# Comparing `string` Objects

`string` objects can also be compared with relational operators. As with individual characters, when two `string` objects are compared, it is actually the ASCII values of the characters making up the strings that are being compared. For example, assume the following definitions exist in a program:

```
string str1 = "ABC";  
string str2 = "XYZ";
```

The `string` object `str1` is considered less than the `string` object `str2` because the characters `"ABC"` alphabetically precede (have lower ASCII values than) the characters `"XYZ"`. So, the following `if` statement will cause the message `"str1 is less than str2."` to be displayed on the screen.

```
if (str1 < str2)  
    cout << "str1 is less than str2.";
```

One by one, each character in the first operand is compared with the character in the corresponding position in the second operand. If all the characters in both `string` objects match, the two strings are

equal. Other relationships can be determined if two characters in corresponding positions do not match. The first operand is less than the second operand if the first mismatched character in the first operand is less than its counterpart in the second operand. Likewise, the first operand is greater than the second operand if the first mismatched character in the first operand is greater than its counterpart in the second operand.

For example, assume a program has the following definitions:

```
string name1 = "Mary";  
string name2 = "Mark";
```

The value in `name1`, `"Mary"`, is greater than the value in `name2`, `"Mark"`. This is because the first three characters in `name1` have the same ASCII values as the first three characters in `name2`, but the `'y'` in the fourth position of `"Mary"` has a greater ASCII value than the `'k'` in the corresponding position of `"Mark"`.

Any of the relational operators can be used to compare two `string` objects. Here are some of the valid comparisons of `name1` and `name2`:

```
name1 > name2 // true  
name1 <= name2 // false  
name1 != name2 // true
```

`string` objects can also, of course, be compared to string literals:

```
name1 < "Mary Jane" // true
```

**Program 4-21** [📄](#) further demonstrates how relational operators can be used with `string` objects.

## Program 4-21

```
1 // This program uses relational operators to
compare a string
2 // entered by the user with valid part
numbers.
3 #include <iostream>
4 #include <iomanip>
5 #include <string>
6 using namespace std;
7
8 int main()
9 {
10     const double PRICE_A = 249.0, // Price
for part A
11     PRICE_B = 199.0; // Price
for part B
12
13     string partNum; // Holds a
part number
14
15     // Display available parts and get the
user's selection
16     cout << "The headphone part numbers
are:\n"
```

```

17         << "Noise canceling: part number S-
29A \n"
18         << "Wireless: part number S-29B \n"
19         << "Enter the part number of the
headphones you\n"
20         << "wish to purchase: ";
21         cin >> partNum;
22
23         // Set the numeric output formatting
24         cout << fixed << showpoint <<
setprecision(2);
25
26         // Determine and display the correct price
27         if (partNum == "S-29A")
28             cout << "The price is $" << PRICE_A <<
endl;
29         else if (partNum == "S-29B")
30             cout << "The price is $" << PRICE_B <<
endl;
31         else
32             cout << partNum << " is not a valid
part number.\n";
33         return 0;
34     }

```

**Program Output with Example Input Shown in Bold**



The headphone part numbers are:

Noise canceling: part number S-29A

Wireless: part number S-29B

Enter the part number of the headphones you  
wish to purchase: **S-29A** Enter

The price is \$249.00



# Checkpoint

4.22 Indicate whether each of the following relational expressions is True or False. Refer to the ASCII table in [Appendix A](#) if necessary.

- A. `'a' < 'z'`
- B. `'a' == 'A'`
- C. `'5' < '7'`
- D. `'a' < 'A'`
- E. `'1' == 1`
- F. `'1' == 49`

4.23 Indicate whether each of the following relational expressions is True or False. Refer to the ASCII table in [Appendix A](#) if necessary.

- A. `"Bill" == "BILL"`
- B. `"Bill" < "BILL"`
- C. `"Bill" < "Bob"`
- D. `"189" > "23"`
- E. `"189" > "Bill"`
- F. `"Mary" < "MaryEllen"`
- G. `"MaryEllen" < "Mary Ellen"`

## 4.13 The Conditional Operator

### Concept:

You can use the conditional operator to create short expressions that work like `if/else` statements.

The conditional operator is powerful and unique. It provides a shorthand method of expressing a simple `if/else` statement. The operator consists of the question-mark (?) and the colon (:). Its format is:

```
expression ? expression : expression;
```

Here is an example of a statement using the conditional operator:

```
x < 0 ? y = 10 : z = 20;
```

The statement above is called a *conditional expression* and consists of three subexpressions separated by the ? and : symbols. The expressions are `x < 0`, `y = 10`, and `z = 20`, as illustrated here:

```
x < 0 ? y = 10 : z = 20;
```



### Note:

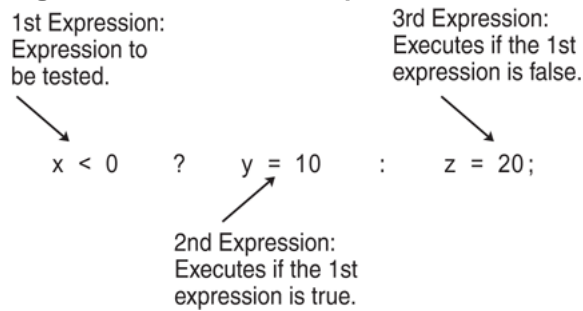
Since it takes three operands, the conditional operator is considered a *ternary* operator.

The conditional expression above performs the same operation as the following `if/else` statement:

```
if (x < 0)
    y = 10;
else
    z = 20;
```

The part of the conditional expression that comes before the question mark is the expression to be tested. It's like the expression in the parentheses of an `if` statement. If the expression is true, the part of the statement between the `?` and the `:` is executed. Otherwise, the part after the `:` is executed. **Figure 4-10** illustrates the roles played by the three subexpressions.

**Figure 4-10 Conditional expression**



If it helps, you can put parentheses around the subexpressions, as in the following:

```
(x < 0) ? (y = 10) : (z = 20);
```


# Using the Value of a Conditional Expression

Remember, in C++ all expressions have a value, and this includes the conditional expression. If the first subexpression is true, the value of the conditional expression is the value of the second subexpression. Otherwise, it is the value of the third subexpression. Here is an example of an assignment statement using the value of a conditional expression:

```
a = x > 100 ? 0 : 1;
```

The value assigned to `a` will be either 0 or 1, depending upon whether `x` is greater than 100. This statement could be expressed as the following `if/else` statement:

```
if (x > 100)
    a = 0;
else
    a = 1;
```

**Program 4-22**  can be used to help a consultant calculate her charges. Her rate is \$50.00 per hour, but her minimum charge is for 5 hours. The conditional operator is used in a statement that ensures the number of hours does not go below five.

## Program 4-22

```
1 // This program calculates a consultant's charges at $50
2 // per hour, for a minimum of 5 hours. The ?: operator
3 // adjusts hours to 5 if less than 5 hours were worked.
4 #include <iostream>
5 #include <iomanip>
6 using namespace std;
7
8 int main()
9 {
10     const double PAY_RATE = 50.0; // Hourly pay rate
11     const int MIN_HOURS = 5;     // Minimum billable hours
12     double hours,                // Hours worked
13     charges;                    // Total charges
14
15     // Get the hours worked.
16     cout << "How many hours were worked? ";
17     cin >> hours;
18
19     // Determine the hours to charge for.
20     hours = hours < MIN_HOURS ? MIN_HOURS : hours;
21
22     // Calculate and display the charges.
23     charges = PAY_RATE * hours;
24     cout << fixed << showpoint << setprecision(2)
25     << "The charges are $" << charges << endl;
26     return 0;
27 }
```

### Program Output with Example Input Shown in Bold

```
How many hours were worked? 10 Enter
The charges are $500.00
```

### Program Output with Example Input Shown in Bold

```
How many hours were worked? 2 Enter
The charges are $250.00
```

Notice in line 11 a constant named `MIN_HOURS` is defined to represent the minimum number of hours, which is 5. Here is the statement in line 20, with the conditional expression:

```
hours = hours < MIN_HOURS ? MIN_HOURS : hours;
```

If the value in `hours` is less than 5, then 5 is stored in `hours`. Otherwise, `hours` is assigned the value it already has. The `hours` variable will not have a value less than 5 when it is used in the next statement, which calculates the consultant's charges.

As you can see, the conditional operator gives you the ability to pack decision-making power into a concise line of code. With a little imagination, it can be applied to many other programming problems. For instance, consider the following statement:

```
cout << "Your grade is: " << (score < 60 ? "Fail." : "Pass.");
```

If you were to use an `if/else` statement, the statement above would be written as follows:

```
if (score < 60)
    cout << "Your grade is: Fail.";
else
    cout << "Your grade is: Pass.";
```



### Note:

The parentheses are placed around the conditional expression because the `<<` operator has higher precedence than the `?:` operator. Without the parentheses, just the value of the expression `score < 60` would be sent to `cout`.



4.24 Rewrite the following `if/else` statements as conditional expressions:

A. 

```
if (x > y)
    z = 1;
else
    z = 20;
```

B. 

```
if (temp > 45)
    population = base * 10;
else
    population = base * 2;
```

C. 

```
if (hours > 40)
    wages *= 1.5;
else
    wages *= 1;
```

D. 

```
if (result >= 0)
    cout << "The result is positive\n";
else
    cout << "The result is negative.\n";
```

4.25 The following statements use conditional expressions. Rewrite each with an `if/else` statement.

- A. `j = k > 90 ? 57 : 12;`
- B. `factor = x >= 10 ? y * 22 : y * 35;`
- C. `total += count == 1 ? sales : count * sales;`
- D. `cout << ((num % 2) == 0) ? "Even\n" : "Odd\n";`

4.26 What will the following program display?



```
#include <iostream>
using namespace std;
int main()
{
    const int UPPER = 8, LOWER = 2;
    int num1, num2, num3 = 12, num4 = 3;
    num1 = num3 < num4 ? UPPER : LOWER;
    num2 = num4 > UPPER ? num3 : LOWER;
    cout << num1 << " " << num2 << endl;
    return 0;
}
```

## 4.14 The `switch` Statement

### Concept:

The `switch` statement lets the value of a variable or an expression determine where the program will branch.

A branch occurs when one part of a program causes another part to execute. The `if/else if` statement allows your program to branch into one of several possible paths. It performs a series of tests (usually relational) and branches when one of these tests is true. The `switch` statement is a similar mechanism. However, it tests the value of an integer expression and then uses that value to determine to which set of statements to branch. Here is the format of the `switch` statement:

```
switch (IntegerExpression)
{
    case ConstantExpression:
        // place one or more
        // statements here
    case ConstantExpression:
        // place one or more
        // statements here
        // case statements may be repeated as many
        // times as necessary
    default:
        // place one or more
        // statements here
}
```

The first line of the statement starts with the word `switch`, followed by an integer expression inside parentheses. This can be either of the following:

- a variable of any of the integer data types (including `char`)
- an expression whose value is of any of the integer data types

On the next line is the beginning of a block containing several `case` statements. Each `case` statement is formatted in the following manner:

```
case ConstantExpression:  
    // place one or more  
    // statements here
```

After the word `case` is a constant expression (which must be of an integer type), followed by a colon. The constant expression may be an integer literal or an integer named constant. The `case` statement marks the beginning of a section of statements. The program branches to these statements if the value of the `switch` expression matches that of the `case` expression.



### **Warning!**

The expression of each `case` statement in the block must be unique.



## Note:

The expression following the word `case` must be an integer literal or constant. It cannot be a variable, and it cannot be an expression such as `x < 22` or `n == 50`.

An optional `default` section comes after all the `case` statements. The program branches to this section if none of the `case` expressions match the `switch` expression. So, it functions like a trailing `else` in an `if/else if` statement.

**Program 4-23**  shows how a simple `switch` statement works.

## Program 4-23

```
1 // The switch statement in this program tells
the user something
2 // he or she already knows: the data just
entered!
3 #include <iostream>
4 using namespace std;
5
6 int main()
7 {
8     char choice;
9
10    cout << "Enter A, B, or C: ";
11    cin >> choice;
12    switch (choice)
13    {
14        case 'A': cout << "You entered A.\n";
15                break;
16        case 'B': cout << "You entered B.\n";
17                break;
18        case 'C': cout << "You entered C.\n";
19                break;
20        default: cout << "You did not enter
A, B, or C!\n";
```

```
21     }  
22     return 0;  
23 }
```

### Program Output with Example Input Shown in Bold

```
Enter A, B, or C: B Enter  
You entered B.
```

### Program Output with Example Input Shown in Bold

```
Enter A, B, or C: F Enter  
You did not enter A, B, or C!
```

The first `case` statement is `case 'A ':`, the second is `case 'B ':`, and the third is `case 'C ':`. These statements mark where the program is to branch to if the variable `choice` contains the values `'A'`, `'B'`, or `'C'`. (Remember, character variables and literals are considered integers.) The `default` section is branched to if the user enters anything other than A, B, or C.

Notice the `break` statements in the `case 'A'`, `case 'B'`, and `case 'C'` sections.

```
switch (choice)
{
    case 'A':cout << "You entered A.\n";
        break; ←
    case 'B':cout << "You entered B.\n";
        break; ←
    case 'C':cout << "You entered C.\n";
        break; ←
    default: cout << "You did not enter A, B, or C!\n";
}
```



The `case` statements show the program where to start executing in the block, and the `break` statements show the program where to stop. Without the `break` statements, the program would execute all of the lines from the matching `case` statement to the end of the block.





## Note:

The `default` section (or the last `case` section, if there is no `default`) does not need a `break` statement. Some programmers prefer to put one there anyway, for consistency.

**Program 4-24**  is a modification of **Program 4-23** , without the `break` statements.

## Program 4-24

```
1 // The switch statement in this program tells
the user something
2 // he or she already knows: the data just
entered!
3 #include <iostream>
4 using namespace std;
5
6 int main()
7 {
8     char choice;
9
10    cout << "Enter A, B, or C: ";
11    cin >> choice;
12    // The following switch is
13    // missing its break statements!
14    switch (choice)
15    {
16        case 'A': cout << "You entered A.\n";
17        case 'B': cout << "You entered B.\n";
18        case 'C': cout << "You entered C.\n";
19        default: cout << "You did not enter
A, B, or C!\n";
20    }
```

```
21     return 0;
22 }
```


### Program Output with Example Input Shown in Bold

```
Enter A, B, or C: A Enter
You entered A.
You entered B.
You entered C.
You did not enter A, B, or C!
```

### Program Output with Example Input Shown in Bold

```
Enter A, B, or C: C Enter
You entered C.
You did not enter A, B, or C!
```

Without the `break` statement, the program “falls through” all of the statements below the one with the matching `case` expression.

Sometimes this is what you want. [Program 4-25](#)  lists the features of three TV models a customer may choose from. The Model 100 has remote control. The Model 200 has remote control and stereo

sound. The Model 300 has remote control, stereo sound, and picture-in-a-picture capability. The program uses a `switch` statement with carefully omitted `break`s to print the features of the selected model.

## Program 4-25

```
1 // This program is carefully constructed to
use the "fall through"
2 // feature of the switch statement.
3 #include <iostream>
4 using namespace std;
5
6 int main()
7 {
8     int modelNum; // Model number
9
10    // Get a model number from the user.
11    cout << "Our TVs come in three models:\n";
12    cout << "The 100, 200, and 300. Which do
you want? ";
13    cin >> modelNum;
14
15    // Display the model's features.
16    cout << "That model has the following
features:\n";
17    switch (modelNum)
18    {
19        case 300: cout << "\tPicture-in-a-
picture.\n";
```

```
20         case 200: cout << "\tStereo sound.\n";
21         case 100: cout << "\tRemote
control.\n";
22             break;
23         default: cout << "You can only choose
the 100,";
24             cout << "200, or 300.\n";
25     }
26     return 0;
27 }
```

### Program Output with Example Input Shown in Bold

```
Our TVs come in three models:
The 100, 200, and 300. Which do you want?
100 Enter
That model has the following features:
    Remote control.
```

### Program Output with Example Input Shown in Bold

```
Our TVs come in three models:  
The 100, 200, and 300. Which do you want?  
200 Enter  
That model has the following features:  
    Stereo sound.  
    Remote control.
```

### Program Output with Example Input Shown in Bold

```
Our TVs come in three models:  
The 100, 200, and 300. Which do you want?  
300 Enter  
That model has the following features:  
    Picture-in-a-picture.  
    Stereo sound.  
    Remote control.
```

### Program Output with Example Input Shown in Bold

```
Our TVs come in three models:  
The 100, 200, and 300. Which do you want?  
500 Enter  
That model has the following features:  
You can only choose the 100, 200, or 300.
```

Another example of how useful this “fall through” capability can be is when you want the program to branch to the same set of statements for multiple `case` expressions. For instance, [Program 4-26](#) asks the user to select a grade of pet food. The available choices are A, B, and C. The `switch` statement will recognize either upper or lowercase letters.



## Program 4-26

```
1 // The switch statement in this program uses
the "fall through"
2 // feature to catch both uppercase and
lowercase letters entered
3 // by the user.
4 #include <iostream>
5 using namespace std;
6
7 int main()
8 {
9     char feedGrade;
10
11     // Get the desired grade of feed.
12     cout << "Our pet food is available in
three grades:\n";
13     cout << "A, B, and C. Which do you want
pricing for? ";
14     cin >> feedGrade;
15
16     // Display the price.
17     switch(feedGrade)
18     {
19         case 'a':
```

```
20         case 'A': cout << "30 cents per
pound.\n";
21             break;
22         case 'b':
23         case 'B': cout << "20 cents per
pound.\n";
24             break;
25         case 'c':
26         case 'C': cout << "15 cents per
pound.\n";
27             break;
28         default: cout << "That is an invalid
choice.\n";
29     }
30     return 0;
31 }
```

### Program Output with Example Input Shown in Bold

```
Our pet food is available in three grades:
A, B, and C. Which do you want pricing for?
b Enter
20 cents per pound.
```

### Program Output with Example Input Shown in Bold

```
Our pet food is available in three grades:  
A, B, and C. Which do you want pricing for?  
B Enter  
20 cents per pound.
```

When the user enters `'a'`, the corresponding `case` has no statements associated with it, so the program falls through to the next `case`, which corresponds with `'A'`.

```
case 'a':  
case 'A': cout << "30 cents per pound.\n";  
break;
```

The same technique is used for `'b'` and `'c'`.

# Using `switch` in Menu Systems

The `switch` statement is a natural mechanism for building menu systems. Recall that [Program 4-18](#) gives a menu to select which health club package the user wishes to purchase. The program uses `if/else if` statements to determine which package the user has selected and displays the calculated charges. [Program 4-27](#) is a modification of that program, using a `switch` statement instead of `if/else if`.

## Program 4-27

```
1 // This program uses a switch statement to
determine
2 // the item selected from a menu.
3 #include <iostream>
4 #include <iomanip>
5 using namespace std;
6
7 int main()
8 {
9     int choice;    // To hold a menu choice
10    int months;    // To hold the number of
months
11    double charges; // To hold the monthly
charges
12
13    // Constants for membership rates
14    const double ADULT = 40.0,
15                CHILD = 20.0,
16                SENIOR = 30.0;
17
18    // Constants for menu choices
19    const int ADULT_CHOICE = 1,
20            CHILD_CHOICE = 2,
```

```
21         SENIOR_CHOICE = 3,
22         QUIT_CHOICE = 4;
23
24     // Display the menu and get a choice.
25     cout << "\t\tHealth Club Membership
Menu\n\n"
26         << "1. Standard Adult Membership\n"
27         << "2. Child Membership\n"
28         << "3. Senior Citizen Membership\n"
29         << "4. Quit the Program\n\n"
30         << "Enter your choice: ";
31     cin >> choice;
32
33     // Set the numeric output formatting.
34     cout << fixed << showpoint <<
setprecision(2);
35
36     // Respond to the user's menu selection.
37     switch (choice)
38     {
39         case ADULT_CHOICE:
40             cout << "For how many months? ";
41             cin >> months;
42             charges = months * ADULT;
43             cout << "The total charges are $"
<< charges << endl;
44             break;
```

```
45
46     case CHILD_CHOICE:
47         cout << "For how many months? ";
48         cin >> months;
49         charges = months * CHILD;
50         cout << "The total charges are $"
<< charges << endl;
51         break;
52
53     case SENIOR_CHOICE:
54         cout << "For how many months? ";
55         cin >> months;
56         charges = months * SENIOR;
57         cout << "The total charges are $"
<< charges << endl;
58         break;
59
60     case QUIT_CHOICE:
61         cout << "Program ending.\n";
62         break;
63
64     default:
65         cout << "The valid choices are 1
through 4. Run the\n"
66             << "program again and
select one of those.\n";
67     }
```

```
68  
69     return 0;  
70 }
```

## Program Output with Example Input Shown in Bold

```
Health Club Membership Menu  
1. Standard Adult Membership  
2. Child Membership  
3. Senior Citizen Membership  
4. Quit the Program  
Enter your choice: 2 Enter  
For how many months? 6 Enter  
The total charges are $120.00
```





4.27 Explain why you cannot convert the following `if/else if` statement into a `switch` statement.

```
if (temp == 100)
    x = 0;
else if (population > 1000)
    x = 1;
else if (rate < .1)
    x = -1;
```

4.28 What is wrong with the following `switch` statement?

```
switch (temp)
{
    case temp < 0 : cout << "Temp is negative.\n";
                    break;
    case temp == 0: cout << "Temp is zero.\n";
                    break;
    case temp > 0 : cout << "Temp is positive.\n";
                    break;
}
```

4.29 What will the following program display?

```

#include <iostream>
using namespace std;
int main()
{
    int funny = 7, serious = 15;
    funny = serious * 2;
    switch (funny)
    {
        case 0 : cout << "That is funny.\n";
                break;
        case 30: cout << "That is serious.\n";
                break;
        case 32: cout << "That is seriously funny.\n";
                break;
        default: cout << funny << endl;
    }
    return 0;
}

```

4.30 Complete the following program skeleton by writing a `switch` statement that displays “one” if the user has entered 1, “two” if the user has entered 2, and “three” if the user has entered 3. If a number other than 1, 2, or 3 is entered, the program should display an error message.

```
#include <iostream>

using namespace std;

int main()
{
    int userNum;

    cout << "Enter one of the numbers 1, 2, or 3: ";

    cin >> userNum;

    //

    // Write the switch statement here.

    //

    return 0;
}
```

4.31 Rewrite the following program. Use a `switch` statement instead of the `if/else if` statement.



```
#include <iostream>
using namespace std;
int main()
{
    int selection;
    cout << "Which formula do you want to see?\n\n";
    cout << "1. Area of a circle\n";
    cout << "2. Area of a rectangle\n";
    cout << "3. Area of a cylinder\n";
    cout << "4. None of them!\n";
    cin >> selection;
    if (selection == 1)
        cout << "Pi times radius squared\n";
    else if (selection == 2)
        cout << "Length times width\n";
    else if (selection == 3)
        cout << "Pi times radius squared times height\n";
    else if (selection == 4)
        cout << "Well okay then, good bye!\n";
    else
        cout << "Not good with numbers, eh?\n";
    return 0;
}
```

## 4.15 More about Blocks and Variable Scope

### Concept:

The scope of a variable is limited to the block in which it is defined.

C++ allows you to create variables almost anywhere in a program.

**Program 4-28**  is a modification of **Program 4-17** , which determines if the user qualifies for a loan. The definitions of the variables `income` and `years` have been moved to later points in the program.

## Program 4-28

```
1 // This program demonstrates late variable
definition
2 #include <iostream>
3 using namespace std;
4
5 int main()
6 {
7     // Constants for minimum income and years
8     const double MIN_INCOME = 35000.0;
9     const int MIN_YEARS = 5;
10
11     // Get the annual income.
12     cout << "What is your annual income? ";
13     double income; // Variable definition
14     cin >> income;
15
16     // Get the number of years at the current
job.
17     cout << "How many years have you worked at
"
18         << "your current job? ";
19     int years; // Variable definition
20     cin >> years;
```


```

21
22     // Determine the user's loan
qualifications.
23     if (income >= MIN_INCOME || years >
MIN_YEARS)
24         cout << "You qualify.\n";
25     else
26     {
27         cout << "You must earn at least $"
28             << MIN_INCOME << " or have been "
29             << "employed more than " <<
MIN_YEARS
30             << " years.\n";
31     }
32     return 0;
33 }


```

It is a common practice to define all of a function's variables at the top of the function. Sometimes, especially in longer programs, it's a good idea to define variables near the part of the program where they are used. This makes the purpose of the variable more evident.

Recall from [Chapter 2](#) that the scope of a variable is defined as the part of the program where the variable may be used.

In **Program 4-28** , the scope of the `income` variable is the part of the program in lines 13 through 32. The scope of the `years` variable is the part of the program in lines 19 through 32.

The variables `income` and `years` are defined inside function `main`'s braces. Variables defined inside a set of braces have *local scope* or *block scope*. They may only be used in the part of the program between their definition and the block's closing brace.

You may define variables inside any block. For example, look at **Program 4-29** . This version of the loan program has the variable `years` defined inside the block of the `if` statement. The scope of `years` is the part of the program in lines 21 through 31.



## Program 4-29

```
1 // This program demonstrates a variable
defined in an inner block.
2 #include <iostream>
3 using namespace std;
4
5 int main()
6 {
7     // Constants for minimum income and years
8     const double MIN_INCOME = 35000.0;
9     const int MIN_YEARS = 5;
10
11     // Get the annual income.
12     cout << "What is your annual income? ";
13     double income; // Variable definition
14     cin >> income;
15
16     if (income >= MIN_INCOME)
17     {
18         // Get the number of years at the
current job.
19         cout << "How many years have you
worked at "
20             << "your current job? ";
```

```

21     int years; // Variable definition
22     cin >> years;
23
24     if (years > MIN_YEARS)
25         cout << "You qualify.\n";
26     else
27     {
28         cout << "You must have been
employed for\n"
29             << "more than " << MIN_YEARS
30             << " years to qualify.\n";
31     }
32 }
33 else
34 {
35     cout << "You must earn at least $" <<
MIN_INCOME
36     << " to qualify.\n";
37 }
38     return 0;
39 }

```

Notice the scope of `years` is only within the block where it is defined. The variable is not visible before its definition or after the


closing brace of the block. This is true of any variable defined inside a set of braces.



**Note:**

When a program is running and it enters the section of code that constitutes a variable's scope, it is said that the variable *comes into scope*. This simply means the variable is now visible and the program may reference it. Likewise, when a variable *leaves scope*, or goes out of scope, it may no longer be used.

# Variables with the Same Name

When a block is nested inside another block, a variable defined in the inner block may have the same name as a variable defined in the outer block. As long as the variable in the inner block is visible, however, the variable in the outer block will be hidden. This is illustrated by [Program 4-30](#) .


## Program 4-30

```
1 // This program uses two variables with the
name number.
2 #include <iostream>
3 using namespace std;
4
5 int main()
6 {
7     // Define a variable named number.
8     int number;
9
10    cout << "Enter a number greater than 0: ";
11    cin >> number;
12    if (number > 0)
13    {
14        int number; // Another variable named
number.
15        cout << "Now enter another number: ";
16        cin >> number;
17        cout << "The second number you entered
was "
18            << number << endl;
19    }
20    cout << "Your first number was " << number
```

```
<< endl;  
21     return 0;  
22 }
```

### Program Output with Example Input Shown in Bold

```
Enter a number greater than 0: 2 Enter  
Now enter another number: 7 Enter  
The second number you entered was 7  
Your first number was 2
```

**Program 4-30**  has two separate variables named `number`. The `cin` and `cout` statements in the inner block (belonging to the `if` statement) can only work with the `number` variable defined in that block. As soon as the program leaves that block, the inner `number` goes out of scope, revealing the outer `number` variable.



## ***Warning!***

Although it's perfectly acceptable to define variables inside nested blocks, you should avoid giving them the same names as variables in the outer blocks. It's too easy to confuse one variable with another.

Case Study: See the Sales Commission Case Study on the computer science portal at [www.pearsonhighered.com/gaddis](http://www.pearsonhighered.com/gaddis).

# Review Questions and Exercises

## Short Answer

1. Describe the difference between the `if/else` if statement and a series of if statements.
2. In an `if/else` if statement, what is the purpose of a trailing else?
3. What is a flag and how does it work?
4. Can an `if` statement test expressions other than relational expressions? Explain.
5. Briefly describe how the `&&` operator works.
6. Briefly describe how the `||` operator works.
7. Why are the relational operators called relational?
8. Why do most programmers indent the conditionally executed statements in a decision structure?



# Fill-in-the-Blank

9. An expression using the greater-than, less-than, greater-than-or-equal-to, less-than-or-equal-to, equal-to, or not-equal-to operator is called a(n) \_\_\_\_\_ expression.
10. A relational expression is either \_\_\_\_\_ or \_\_\_\_\_.
11. The value of a relational expression is 0 if the expression is \_\_\_\_\_ or 1 if the expression is \_\_\_\_\_.
12. The `if` statement regards an expression with the value 0 as \_\_\_\_\_.
13. The `if` statement regards an expression with a nonzero value as \_\_\_\_\_.
14. For an `if` statement to conditionally execute a group of statements, the statements must be enclosed in a set of \_\_\_\_\_.
15. In an `if/else` statement, the `if` part executes its statement or block if the expression is \_\_\_\_\_, and the else part executes its statement or block if the expression is \_\_\_\_\_.
16. The trailing else in an `if/else if` statement has a similar purpose as the \_\_\_\_\_ section of a `switch` statement.
17. The `if/else if` statement is actually a form of the \_\_\_\_\_ if statement.
18. If the subexpression on the left of the \_\_\_\_\_ logical operator is false, the right subexpression is not checked.
19. If the subexpression on the left of the \_\_\_\_\_ logical operator is true, the right subexpression is not checked.

20. The \_\_\_\_\_ logical operator has higher precedence than the other logical operators.
21. The logical operators have \_\_\_\_\_ associativity.
22. The \_\_\_\_\_ logical operator works best when testing a number to determine if it is within a range.
23. The \_\_\_\_\_ logical operator works best when testing a number to determine if it is outside a range.
24. A variable with \_\_\_\_\_ scope is only visible when the program is executing in the block containing the variable's definition.
25. You use the \_\_\_\_\_ operator to determine whether one `string` object is greater than another `string` object.
26. An expression using the conditional operator is called a(n) \_\_\_\_\_ expression.
27. The expression that is tested by a `switch` statement must have a(n) \_\_\_\_\_ value.
28. The expression following a `case` statement must be a(n) \_\_\_\_\_.
29. A program will "fall through" a `case` section if it is missing the \_\_\_\_\_ statement.
30. What value will be stored in the variable `t` after each of the following statements executes?
- A. `t = (12 > 1);` \_\_\_\_\_
  - B. `t = (2 < 0);` \_\_\_\_\_
  - C. `t = (5 == (3 * 2));` \_\_\_\_\_
  - D. `t = (5 == 5);` \_\_\_\_\_

# Algorithm Workbench

31. Write an `if` statement that assigns 100 to `x` when `y` is equal to 0.
32. Write an `if/else` statement that assigns 0 to `x` when `y` is equal to 10. Otherwise, it should assign 1 to `x`.
33. Using the following chart, write an `if/else if` statement that assigns .10, .15, or .20 to `commission`, depending on the value in `sales`.
34. Write an `if` statement that sets the variable `hours` to 10 when the flag variable `minimum` is set.
35. Write nested `if` statements that perform the following tests: If `amount1` is greater than 10 and `amount2` is less than 100, display the greater of the two.
36. Write an `if` statement that prints the message “The number is valid” if the variable `grade` is within the range 0 through 100.
37. Write an `if` statement that prints the message “The number is valid” if the variable `temperature` is within the range -50 through 150.
38. Write an `if` statement that prints the message “The number is not valid” if the variable `hours` is outside the range 0 through 80.
39. Assume `str1` and `str2` are `string` objects that have been initialized with different values. Write an `if/else` statement

that compares the two objects and displays the one that is alphabetically greatest.

40. Convert the following `if/else if` statement into a `switch` statement:

```
if (choice == 1)
{
    cout << fixed << showpoint << setprecision(2);
}
else if (choice == 2 || choice == 3)
{
    cout << fixed << showpoint << setprecision(4);
}
else if (choice == 4)
{
    cout << fixed << showpoint << setprecision(6);
}
else
{
    cout << fixed << showpoint << setprecision(8);
}
```

41. Match the conditional expression with the `if/else` statement that performs the same operation.

- A. `q = x < y ? a + b : x * 2;`
- B. `q = x < y ? x * 2 : a + b;`
- C. `x < y ? q = 0 : q = 1;`

```
_____ if (x < y)
```

```
_____ q = 0;
```

```
_____ else
```

```
_____ q = 1;
```

```
_____ if (x < y)
```

```
_____ q = a + b;
```

```
_____ else
```

```
_____ q = x * 2;
```

```
_____ if (x < y)
```

```
_____ q = x * 2;
```

```
_____ else
```

```
_____ q = a + b;
```

# True or False

42. T F The `= operator` and the `==` operator perform the same operation when used in a Boolean expression.
43. T F A variable defined in an inner block may not have the same name as a variable defined in the outer block.
44. T F A conditionally executed statement should be indented one level from the `if` statement.
45. T F All lines in a block should be indented one level.
46. T F It's safe to assume that all uninitialized variables automatically start with 0 as their value.
47. T F When an `if` statement is nested in the `if` part of another statement, the only time the inner `if` is executed is when the expression of the outer `if` is true.
48. T F When an `if` statement is nested in the `else` part of another statement, as in an `if/else if`, the only time the inner `if` is executed is when the expression of the outer `if` is true.
49. T F The scope of a variable is limited to the block in which it is defined.
50. T F You can use the relational operators to compare `string` objects.
51. T F `x != y` is the same as `(x > y || x < y)`
52. T F `y < x` is the same as `x >= y`
53. T F `x >= y` is the same as `(x > y && x = y)`

Assume the variables `x = 5`, `y = 6`, and `z = 8`. Indicate by circling the T or F whether each of the following conditions is True or False:

54. T F `x == 5 || y > 3`

55. T F `7 <= x && z > 4`

56. T F `2 != y && z != 4`

57. T F `x >= 0 || x <= y`

# Find the Errors

Each of the following programs has errors. Find as many as you can.



58.

```
// This program averages 3 test scores.  
// It uses the variable perfectScore as a flag.  
include <iostream>  
using namespace std;  
int main()  
{  
    cout << "Enter your 3 test scores and I will ";  
        << "average them:";  
    int score1, score2, score3,  
    cin >> score1 >> score2 >> score3;  
    double average;  
    average = (score1 + score2 + score3) / 3.0;  
    if (average = 100);  
        perfectScore = true; // Set the flag variable  
    cout << "Your average is " << average << endl;  
    bool perfectScore;  
    if (perfectScore);  
    {  
        cout << "Congratulations!\n";  
        cout << "That's a perfect score.\n";  
        cout << "You deserve a pat on the back!\n";  
    }  
    return 0;  
}
```

59.

```
// This program divides a user-supplied number by another
// user-supplied number. It checks for division by zero.
#include <iostream>
using namespace std;
int main()
{
    double num1, num2, quotient;
    cout << "Enter a number: ";
    cin >> num1;
    cout << "Enter another number: ";
    cin >> num2;
    if (num2 == 0)
        cout << "Division by zero is not possible.\n";
        cout << "Please run the program again ";
        cout << "and enter a number besides zero.\n";
    else
        quotient = num1 / num2;
        cout << "The quotient of " << num1 <<
        cout << " divided by " << num2 << " is ";
        cout << quotient << endl;
    return 0;
}
```

60.

```
// This program uses an if/else if statement to assign a
// letter grade (A, B, C, D, or F) to a numeric test
score.
#include <iostream>
using namespace std;
int main()
{
    int testScore;
    cout << "Enter your test score and I will tell
you\n";
    cout << "the letter grade you earned: ";
    cin >> testScore;
    if (testScore < 60)
        cout << "Your grade is F.\n";
    else if (testScore < 70)
        cout << "Your grade is D.\n";
    else if (testScore < 80)
        cout << "Your grade is C.\n";
    else if (testScore < 90)
        cout << "Your grade is B.\n";
    else
        cout << "That is not a valid score.\n";
    else if (testScore <= 100)
        cout << "Your grade is A.\n";
    return 0;
}
```

61.

```
// This program uses a switch-case statement to assign a
// letter grade (A, B, C, D, or F) to a numeric test
score.
#include <iostream>
using namespace std;
int main()
{
    double testScore;
    cout << "Enter your test score and I will tell
you\n";
    cout << "the letter grade you earned: ";
    cin >> testScore;
    switch (testScore)
    {
        case (testScore < 60.0):
            cout << "Your grade is F.\n";
            break;
        case (testScore < 70.0):
            cout << "Your grade is D.\n";
            break;
        case (testScore < 80.0):
            cout << "Your grade is C.\n";
            break;
        case (testScore < 90.0):
            cout << "Your grade is B.\n";
            break;
        case (testScore <= 100.0):
```

```
        cout << "Your grade is A.\n";
    }
    break;
default:
    cout << "That score isn't valid\n";
return 0;
}
```

62. The following statement should determine if `x` is not greater than 20. What is wrong with it?

```
if (!x > 20)
```

63. The following statement should determine if `count` is within the range of 0 through 100. What is wrong with it?

```
if (count >= 0 || count <= 100)
```

64. The following statement should determine if `count` is outside the range of 0 through 100. What is wrong with it?

```
if (count < 0 && count > 100)
```

65. The following statement should assign 0 to `z` if `a` is less than 10, otherwise it should assign 7 to `z`. What is wrong with it?

```
z = (a < 10) : 0 ? 7;
```

# Programming Challenges

## 1. Minimum/Maximum

Write a program that asks the user to enter two numbers. The program should use the conditional operator to determine which number is the smaller and which is the larger.

## 2. Roman Numeral Converter

Write a program that asks the user to enter a number within the range of 1 through 10. Use a `switch` statement to display the Roman numeral version of that number.

*Input Validation: Do not accept a number less than 1 or greater than 10.*

## 3. Magic Dates

The date June 10, 1960 is special because when we write it in the following format, the month times the day equals the year.

6/10/60

Write a program that asks the user to enter a month (in numeric form), a day, and a two-digit year. The program should then determine whether the month times the day is equal to the year. If so, it should display a message saying the date is magic. Otherwise, it should display a message saying the date is not magic.

## 4. Areas of Rectangles

The area of a rectangle is the rectangle's length times its width. Write a program that asks for the length and width of two rectangles. The program should tell the user which rectangle has the greater area, or if the areas are the same.

## 5. Body Mass Index

Write a program that calculates and displays a person's body mass index (BMI). The BMI is often used to determine whether a person is overweight or underweight for his or her height. A person's BMI is calculated with the following formula:

$$BMI = weight \times 703 / height^2$$

where *weight* is measured in pounds and *height* is measured in inches. The program should display a message indicating whether the person has optimal weight, is underweight, or is overweight. A person's weight is considered to be optimal if his or her BMI is between 18.5 and 25. If the BMI is less than 18.5, the person is considered to be underweight. If the BMI value is greater than 25, the person is considered to be overweight.

## 6. Mass and Weight

Scientists measure an object's mass in kilograms and its weight in newtons. If you know the amount of mass that an object has, you can calculate its weight, in newtons, with the following formula:

$$Weight = mass \times 9.8$$

Write a program that asks the user to enter an object's mass, then calculates and displays its weight. If the object weighs more than 1,000 newtons, display a message indicating that it is too heavy. If the object weighs less than 10 newtons, display a message indicating that the object is too light.

### 7. Time Calculator

Write a program that asks the user to enter a number of seconds.



#### Solving the Time Calculator Problem

- There are 60 seconds in a minute. If the number of seconds entered by the user is greater than or equal to 60, the program should display the number of minutes in that many seconds.
- There are 3,600 seconds in an hour. If the number of seconds entered by the user is greater than or equal to 3,600, the program should display the number of hours in that many seconds.
- There are 86,400 seconds in a day. If the number of seconds entered by the user is greater than or equal to 86,400, the program should display the number of days in that many seconds.

### 8. Color Mixer

The colors red, blue, and yellow are known as primary colors because they cannot be made by mixing other colors. When you mix two primary colors, you get a secondary color, as shown here: When you mix red and blue, you get purple.

When you mix red and yellow, you get orange.

When you mix blue and yellow, you get green.

Write a program that prompts the user to enter the names of two primary colors to mix. If the user enters anything other than "red," "blue," or "yellow," the program should display an error message. Otherwise, the program should display the name of the secondary color that results by mixing two primary colors.

### 9. Change for a Dollar Game

Create a change-counting game that gets the user to enter the number of coins required to make exactly one dollar. The program should ask the user to enter the number of pennies, nickels, dimes, and quarters. If the total value of the coins entered is equal to one dollar, the program should congratulate the user for winning the game. Otherwise, the program should display a message indicating whether the amount entered was more than or less than one dollar.

### 10. Days in a Month



Write a program that asks the user to enter the month (letting the user enter an integer in the range of 1 through 12) and the year. The program should then display the number of days in that month. Use the following criteria to identify leap years:

1. Determine whether the year is divisible by 100. If it is, then it is a leap year if and only if it is divisible by 400. For example, 2000 is a leap year but 2100 is not.
2. If the year is not divisible by 100, then it is a leap year if and only if it is divisible by 4. For example, 2008 is a leap year but 2009 is not.

Here is a sample run of the program:

```
Enter a month (1-12): 2 Enter
Enter a year: 2008 Enter
29 days
```

#### 11. Math Tutor

This is a modification of Programming Challenge 17 from [Chapter 3](#). Write a program that can be used as a math tutor for a young student. The program should display two random numbers that are to be added, such as:

$$\begin{array}{r} 247 \\ + 129 \end{array}$$

The program should wait for the student to enter the answer. If the answer is correct, a message of congratulations should be printed. If the answer is incorrect, a message should be printed showing the correct answer.

#### 12. Software Sales

A software company sells a package that retails for \$99. Quantity discounts are given according to the following table.

Write a program that asks for the number of units sold and computes the total cost of the purchase.

*Input Validation: Make sure the number of units is greater than 0.*

#### 13. Book Club Points

Serendipity Booksellers has a book club that awards points to its customers based on the number of books purchased each month. The points are awarded as follows:

- If a customer purchases 0 books, he or she earns 0 points.
- If a customer purchases 1 book, he or she earns 5 points.
- If a customer purchases 2 books, he or she earns 15 points.
- If a customer purchases 3 books, he or she earns 30 points.
- If a customer purchases 4 or more books, he or she earns 60 points.

Write a program that asks the user to enter the number of books he or she has purchased this month then displays the number of points awarded.

#### 14. Bank Charges

A bank charges \$10 per month plus the following check fees for a commercial checking account:  
\$.10 each for fewer than 20 checks

\$.08 each for 20–39 checks

\$.06 each for 40–59 checks

\$.04 each for 60 or more checks

The bank also charges an extra \$15 if the balance of the account falls below \$400 (before any check fees are applied). Write a program that asks for the beginning balance and the number of checks written. Compute and display the bank's service fees for the month.

*Input Validation: Do not accept a negative value for the number of checks written. If a negative value is given for the beginning balance, display an urgent message indicating the account is overdrawn.*

#### 15. **Shipping Charges**

The Fast Freight Shipping Company charges the following rates:

Write a program that asks for the weight of the package and the distance it is to be shipped, then displays the charges.

*Input Validation: Do not accept values of 0 or less for the weight of the package. Do not accept weights of more than 20 kg (this is the maximum weight the company will ship). Do not accept distances of less than 10 miles or more than 3,000 miles. These are the company's minimum and maximum shipping distances.*

#### 16. **Running the Race**

Write a program that asks for the names of three runners and the time it took each of them to finish a race. The program should display who came in first, second, and third place.

*Input Validation: Only accept positive numbers for the times.*

#### 17. **Personal Best**

Write a program that asks for the name of a pole vaulter and the dates and vault heights (in meters) of the athlete's three best vaults. It should then report, in order of height (best first), the date on which each vault was made and its height.

*Input Validation: Only accept values between 2.0 and 5.0 for the heights.*

#### 18. **Fat Gram Calculator**

Write a program that asks for the number of calories and fat grams in a food. The program should display the percentage of calories that come from fat. If the calories from fat are less than 30 percent of the total calories of the food, it should also display a message indicating that the food is low in fat.

One gram of fat has 9 calories, so

Calories from fat = fat grams \* 9

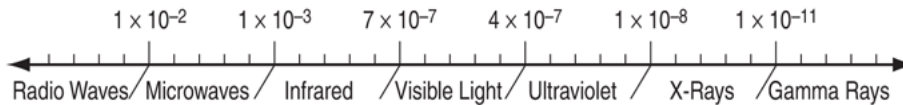
The percentage of calories from fat can be calculated as

Calories from fat / total calories

*Input Validation: Make sure the number of calories and fat grams are not less than 0. Also, the number of calories from fat cannot be greater than the total number of calories. If that happens, display an error message indicating that either the calories or fat grams were incorrectly entered.*

### 19. Spectral Analysis

If a scientist knows the wavelength of an electromagnetic wave, he or she can determine what type of radiation it is. Write a program that asks for the wavelength of an electromagnetic wave in meters and then displays what that wave is according to the chart below. (For example, a wave with a wavelength of  $1 \times 10^{10}$  meters would be an X-ray.)



### 20. The Speed of Sound

The following table shows the approximate speed of sound in air, water, and steel.

Write a program that displays a menu allowing the user to select air, water, or steel. After the user has made a selection, he or she should be asked to enter the distance a sound wave will travel in the selected medium. The program will then display the amount of time it will take. (Round the answer to four decimal places.)

*Input Validation: Check that the user has selected one of the available choices from the menu. Do not accept distances less than 0.*

### 21. The Speed of Sound in Gases

When sound travels through a gas, its speed depends primarily on the density of the medium. The less dense the medium, the faster the speed will be. The following table shows the approximate speed of sound at 0 degrees centigrade, measured in meters per second, when traveling through carbon dioxide, air, helium, and hydrogen.

Write a program that displays a menu allowing the user to select one of these four gases. After a selection has been made, the user should enter the number of seconds it took for the sound to travel in this medium from its source to the location at which it was detected. The program should then report how far away (in meters) the source of the sound was from the detection location.

*Input Validation: Check that the user has selected one of the available menu choices. Do not accept times less than 0 seconds or more than 30 seconds.*

### 22. Freezing and Boiling Points

The following table lists the freezing and boiling points of several substances. Write a program that asks the user to enter a temperature then shows all the substances that will freeze at that temperature, and all that will boil at that temperature. For example, if the user enters 220, the program should report that water will freeze and oxygen will boil at that temperature.

### 23. Geometry Calculator

Write a program that displays the following menu:

```
Geometry Calculator
```

```
1. Calculate the Area of a Circle
```

```
2. Calculate the Area of a Rectangle
```

```
3. Calculate the Area of a Triangle
```

```
4. Quit
```

```
Enter your choice (124):
```

If the user enters 1, the program should ask for the radius of the circle then display its area. Use the following formula:

$$\text{area} = \pi r^2$$

Use 3.14159 for  $\pi$  and the radius of the circle for  $r$ . If the user enters 2, the program should ask for the length and width of the rectangle, then display the rectangle's area. Use the following formula:

```
area = length * width
```

If the user enters 3, the program should ask for the length of the triangle's base and its height, then display its area. Use the following formula:

```
area = base * height * .5
```

If the user enters 4, the program should end.

*Input Validation: Display an error message if the user enters a number outside the range of 1 through 4 when selecting an item from the menu. Do not accept negative values for the circle's radius, the rectangle's length or width, or the triangle's base or height.*

#### 24. Long-Distance Calls

A long-distance carrier charges the following rates for telephone calls:

Write a program that asks for the starting time and the number of minutes of the call, and displays the charges. The program should ask for the time to be entered as a floating-point number in the form HH.MM. For example, 07:00 hours will be entered as 07.00, and 16:28 hours will be entered as 16.28.

*Input Validation: The program should not accept times that are greater than 23:59. Also, no number whose last two digits are greater than 59 should be accepted. Hint: Assuming num is a floating-point variable, the following expression will give you its fractional part:*

```
num - static_cast<int>(num)
```

#### 25. Mobile Service Provider

A mobile phone service provider has three different data plans for its customers:  
Write a program that calculates a customer's monthly bill. It should ask which package the customer has purchased and how many gigabytes were used. It should then display the total amount due.

*Input Validation: Be sure the user only selects package A, B, or C.*

**26. Mobile Service Provider, Part 2**

Modify the Program in Programming Challenge 25 so it also displays how much money Package A customers would save if they purchased packages B or C, and how much money Package B customers would save if they purchased Package C. If there would be no savings, no message should be printed.

**27. Wi-Fi Diagnostic Tree**


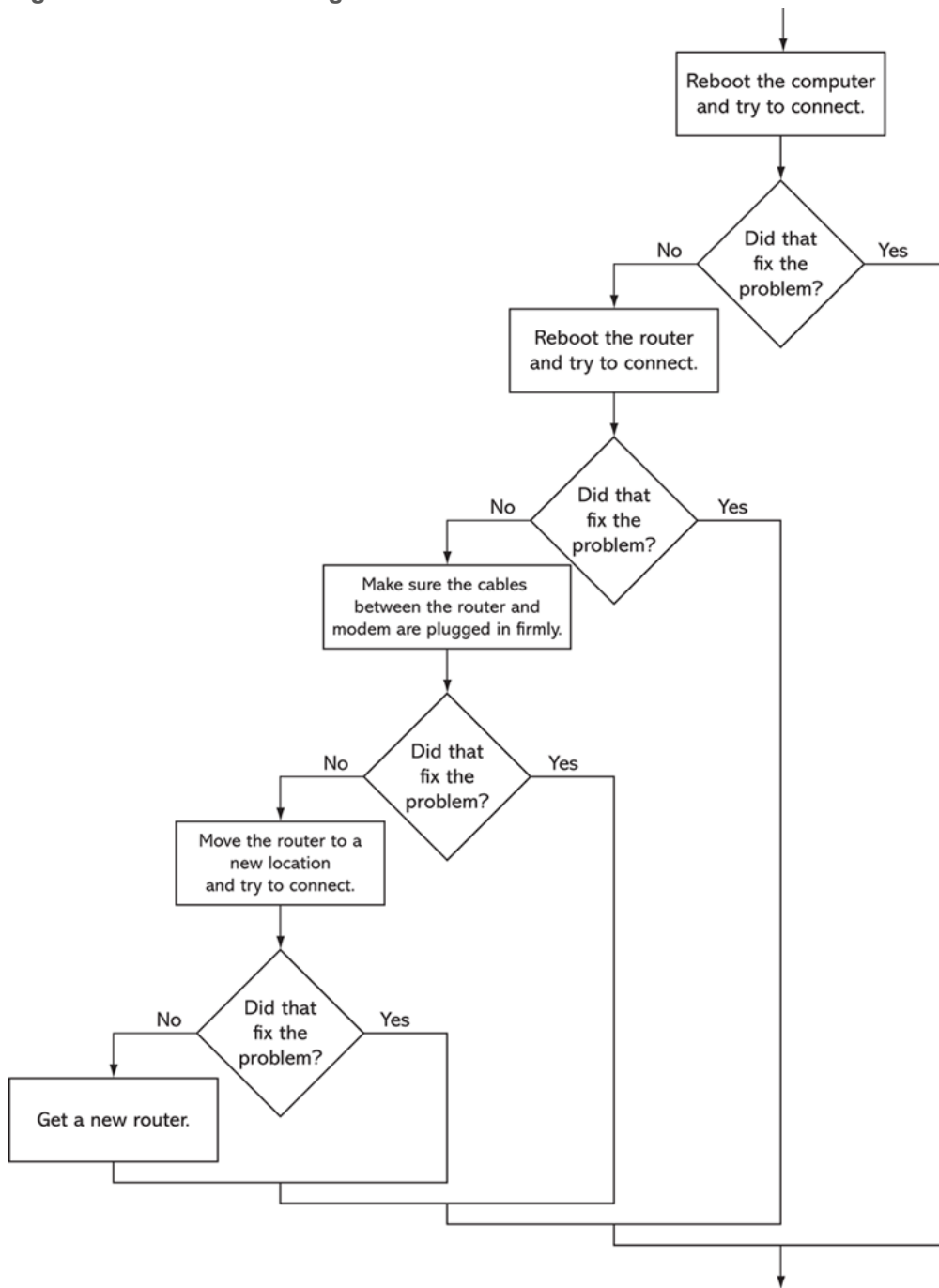
**Figure 4-11**  shows a simplified flowchart for troubleshooting a bad Wi-Fi connection. Use the flowchart to create a program that leads a person through the steps of fixing a bad Wi-Fi connection. Here is an example of the program's output:

Figure 4-11 Troubleshooting a bad Wi-Fi connection



Reboot the computer and try to connect.

Did that fix the problem? **no** Enter

Reboot the router and try to connect.

Did that fix the problem? **yes**

Notice the program ends as soon as a solution is found to the problem. Here is another example of the program's output:

```
Reboot the computer and try to connect.  
Did that fix the problem? no Enter  
Reboot the router and try to connect.  
Did that fix the problem? no Enter  
Make sure the cables between the router and modem are plugged in firmly.  
Did that fix the problem? no Enter  
Move the router to a new location.  
Did that fix the problem? no Enter  
Get a new router.
```

## 28. Restaurant Selector

You have a group of friends coming to visit for your high school reunion, and you want to take them out to eat at a local restaurant. You aren't sure if any of them have dietary restrictions, but your restaurant choices are as follows:

*Joe's Gourmet Burgers*—Vegetarian: No, Vegan: No, Gluten-Free: No

*Main Street Pizza Company*—Vegetarian: Yes, Vegan: No, Gluten-Free: Yes

*Corner Café*—Vegetarian: Yes, Vegan: Yes, Gluten-Free: Yes

*Mama's Fine Italian*—Vegetarian: Yes, Vegan: No, Gluten-Free: No

*The Chef's Kitchen*—Vegetarian: Yes, Vegan: Yes, Gluten-Free: Yes

Write a program that asks whether any members of your party are vegetarian, vegan, or gluten-free, then displays only the restaurants that you may take the group to. Here is an example of the program's output:

```
Is anyone in your party a vegetarian? yes Enter  
Is anyone in your party a vegan? no Enter  
Is anyone in your party gluten-free? yes Enter  
Here are your restaurant choices:  
Main Street Pizza Company  
Corner Cafe  
The Chef's Kitchen
```

Here is another example of the program's output:

Is anyone in your party a vegetarian? **yes** Enter

Is anyone in your party a vegan? **yes** Enter

Is anyone in your party gluten-free? **yes** Enter

Here are your restaurant choices:

Corner Cafe

The Chef's Kitchen



---

# Chapter 5 Loops and Files

---

## Topics

5.1 The Increment and Decrement Operators 

5.2 Introduction to Loops: The `while` Loop 

5.3 Using the `while` Loop for Input Validation 

5.4 Counters 

5.5 The `do-while` Loop 

5.6 The `for` Loop 

5.7 Keeping a Running Total 

5.8 Sentinels 

5.9 Focus on Software Engineering: Deciding Which Loop to Use 

5.10 Nested Loops 

5.11 Using Files for Data Storage 

# 5.12 Optional Topics: Breaking and Continuing a Loop

# 5.1 The Increment and Decrement Operators

## Concept:

`++` and `--` are operators that add and subtract 1 from their operands.

To *increment* a value means to increase it by one, and to *decrement* a value means to decrease it by one. Both of the following statements increment the variable `num`:

```
num = num + 1;  
num += 1;
```

And `num` is decremented in both of the following statements:

```
num = num - 1;  
num -= 1;
```

C++ provides a set of simple unary operators designed just for incrementing and decrementing variables. The increment operator is `++`, and the decrement operator is `--`. The following statement uses the `++` operator to increment `num`:

```
num++;
```

And the following statement decrements `num`:

```
num--;
```




### Note:

The expression `num++` is pronounced “num plus plus,” and `num--` is pronounced “num minus minus.”

Our examples so far show the increment and decrement operators used in *postfix mode*, which means the operator is placed after the variable. The operators also work in *prefix mode*, where the operator is placed before the variable name:

```
++num;
```

```
--num;
```

In both postfix and prefix modes, these operators add 1 to or subtract 1 from their operand. [Program 5-1](#)  shows how they work.

## Program 5-1

```
1 // This program demonstrates the ++ and --
operators.
2 #include <iostream>
3 using namespace std;
4
5 int main()
6 {
7     int num = 4; // num starts out with 4.
8
9     // Display the value in num.
10    cout << "The variable num is " << num <<
endl;
11    cout << "I will now increment num.\n\n";
12
13    // Use postfix ++ to increment num.
14    num++;
15    cout << "Now the variable num is " << num
<< endl;
16    cout << "I will increment num again.\n\n";
17
18    // Use prefix ++ to increment num.
19    ++num;
20    cout << "Now the variable num is " << num
```

```
<< endl;
21     cout << "I will now decrement num.\n\n";
22
23     // Use postfix -- to decrement num.
24     num--;
25     cout << "Now the variable num is " << num
<< endl;
26     cout << "I will decrement num again.\n\n";
27
28     // Use prefix -- to increment num.
29     --num;
30     cout << "Now the variable num is " << num
<< endl;
31     return 0;
32 }
```

## Program Output

The variable num is 4

I will now increment num.

Now the variable num is 5

I will increment num again.

Now the variable num is 6

I will now decrement num.

Now the variable num is 5

I will decrement num again.

Now the variable num is 4



# The Difference between Postfix and Prefix Modes

In the simple statements used in [Program 5-1](#), it doesn't matter if the increment or decrement operator is used in postfix or prefix mode. The difference is important, however, when these operators are used in statements that do more than just incrementing or decrementing. For example, look at the following statements:

```
num = 4;  
cout << num++;
```

This `cout` statement is doing two things: (1) displaying the value of `num`, and (2) incrementing `num`. But which happens first? `cout` will display a different value if `num` is incremented first than if `num` is incremented last. The answer depends on the mode of the increment operator.

Postfix mode causes the increment to happen after the value of the variable is used in the expression. In the example, `cout` will display 4, then `num` will be incremented to 5. Prefix mode, however, causes the increment to happen first. In the following statements, `num` will be incremented to 5, then `cout` will display 5:

```
num = 4;  
cout << ++num;
```

**Program 5-2**  illustrates these dynamics further.

## Program 5-2

```
1 // This program demonstrates the prefix and
postfix
2 // modes of the increment and decrement
operators.
3 #include <iostream>
4 using namespace std;
5
6 int main()
7 {
8     int num = 4;
9
10    cout << num << endl;        // Displays 4
11    cout << num++ << endl;      // Displays 4,
then adds 1 to num
12    cout << num << endl;        // Displays 5
13    cout << ++num << endl;      // Adds 1 to
num, then displays 6
14    cout << endl;             // Displays a
blank line
15
16    cout << num << endl;        // Displays 6
17    cout << num-- << endl;     // Displays 6,
then subtracts 1 from num
```

```
18     cout << num << endl;           // Displays 5
19     cout << --num << endl;         // Subtracts 1
from num, then displays 4
20
21     return 0;
22 }
```

## Program Output

```
4
4
5
6

6
6
5
4
```

Let's analyze the statements in this program. In line 8, `num` is initialized with the value 4, so the `cout` statement in line 10 displays 4. Then, line 11 sends the expression `num++` to `cout`. Because the

`++` operator is used in postfix mode, the value 4 is first sent to `cout`, and then 1 is added to `num`, making its value 5.

When line 12 executes, `num` will hold the value 5, so 5 is displayed. Then, line 13 sends the expression `++num` to `cout`. Because the `++` operator is used in prefix mode, 1 is first added to `num` (making it 6), and then the value 6 is sent to `cout`. This same sequence of events happens in lines 16 through 19, except the `--` operator is used.

For another example, look at the following code:

```
int x = 1;
int y
y = x++;    // Postfix increment
```

The first statement defines the variable `x` (initialized with the value 1), and the second statement defines the variable `y`. The third statement does two things:

- It assigns the value of `x` to the variable `y`.
- The variable `x` is incremented.

The value that will be stored in `y` depends on when the increment takes place. Because the `++` operator is used in postfix mode, it acts *after* the assignment takes place. So, this code will store 1 in `y`.

After the code has executed, `x` will contain 2. Let's look at the same code, but with the `++` operator used in prefix mode:

```
int x = 1;
int y;
y = ++x;    // Prefix increment
```

In the third statement, the `++` operator is used in prefix mode, so it acts on the variable `x` before the assignment takes place. So, this code will store 2 in `y`. After the code has executed, `x` will also contain 2.

# Using `++` and `--` in Mathematical Expressions

The increment and decrement operators can also be used on variables in mathematical expressions. Consider the following program segment:

```
a = 2;  
b = 5;  
c = a * b++;  
cout << a << " " << b << " " << c;
```

In the statement `c = a * b++`, `c` is assigned the value of `a` times `b`, which is 10. The variable `b` is then incremented. The `cout` statement will display

```
2 6 10
```

If the statement were changed to read

```
c = a * ++b;
```

the variable `b` would be incremented before it was multiplied by `a`. In this case, `c` would be assigned the value of 2 times 6, so the `cout` statement would display

```
2 6 12
```

You can pack a lot of action into a single statement using the increment and decrement operators, but don't get too tricky with them. You might be tempted to try something like the following, thinking that `c` will be assigned 11:

```
a = 2;  
b = 5;  
c = ++(a * b); // Error!
```

But this assignment statement simply will not work because the operand of the increment and decrement operators must be an lvalue. Recall from [Chapter 2](#) that an lvalue identifies a place in memory whose contents may be changed. The increment and decrement operators usually have variables for their operands, but generally speaking, anything that can go on the left side of an `=` operator is legal.



# Using `++` and `--` in Relational Expressions

Sometimes you will see code where the `++` and `--` operators are used in relational expressions. Just as in mathematical expressions, the difference between postfix and prefix modes is critical. Consider the following program segment:

```
x = 10;
if (x++ > 10)
    cout << "x is greater than 10.\n";
```

Two operations are happening in this `if` statement: (1) The value in `x` is tested to determine if it is greater than 10, and (2) `x` is incremented. Because the increment operator is used in postfix mode, the comparison happens first. Since 10 is not greater than 10, the `cout` statement won't execute. If the mode of the increment operator is changed, however, the `if` statement will compare 11 to 10, and the `cout` statement will execute:

```
x = 10;
if (++x > 10)
    cout << "x is greater than 10.\n";
```

## Checkpoint

5.1 What will the following program segments display?

- A. `x = 2; y = x++; cout << x << y;`
- B. `x = 2; y = ++x; cout << x << y;`
- C. `x = 2; y = 4; cout << x++ << --y;`
- D. `x = 2; y = 2 * x++; cout << x << y;`
- E. `x = 99; if (x++ < 100) cout << "It is true!\n";`  
`else cout << "It is false!\n";`
- F. `x = 0; if (++x) cout << "It is true!\n"; else`  
`cout << "It is false!\n";`

## 5.2 Introduction to Loops: The `while` Loop

### Concept:

A loop is part of a program that repeats.



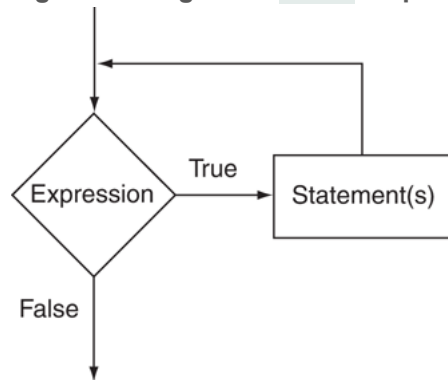
### The `while` Loop

**Chapter 4** introduced the concept of control structures, which direct the flow of a program. A *loop* is a control structure that causes a statement or group of statements to repeat. C++ has three looping control structures: the `while` loop, the `do-while` loop, and the `for` loop. The difference between these structures is how they control the repetition.

# The `while` Loop

The `while` loop has two important parts: (1) an expression that is tested for a true or false value, and (2) a statement or block that is repeated as long as the expression is true. [Figure 5-1](#) shows the logic of a `while` loop.

**Figure 5-1** Logic of a `while` loop



Here is the general format of the `while` loop:

```
while (expression)
    statement;
```

In the general format, `expression` is any expression that can be evaluated as true or false, and `statement` is any valid C++ statement. The first line shown in the format is sometimes called the *loop header*. It consists of the key word `while` followed by an `expression` enclosed in parentheses.


Here's how the loop works: the `expression` is tested, and if it is true, the `statement` is executed. Then, the `expression` is tested again. If it is true, the `statement` is executed. This cycle repeats until the `expression` is false.

The statement that is repeated is known as the *body* of the loop. It is also considered a conditionally executed statement, because it is executed only under the condition that the `expression` is true.

Notice there is no semicolon after the expression in parentheses. Like the `if` statement, the `while` loop is not complete without the statement that follows it.

If you wish the `while` loop to repeat a block of statements, its format is:

```
while (expression)
{
    statement;
    statement;
    // Place as many statements here
    // as necessary.
}
```

The `while` loop works like an `if` statement that executes over and over. As long as the expression inside the parentheses is true, the conditionally executed statement or block will repeat. [Program 5-3](#)  uses the `while` loop to print “Hello” five times.

## Program 5-3

```
1 // This program demonstrates a simple while loop.
2 #include <iostream>
3 using namespace std;
4
5 int main()
6 {
7     int number = 0;
8
9     while (number < 5)
10    {
11        cout << "Hello\n";
12        number++;
13    }
14    cout << "That's all!\n";
15    return 0;
16 }
```

## Program Output

```
Hello
Hello
Hello
Hello
Hello
That's all!
```

Let's take a closer look at this program. In line 7, an integer variable, `number`, is defined and initialized with the value 0. In line 9, the `while` loop begins with this statement:

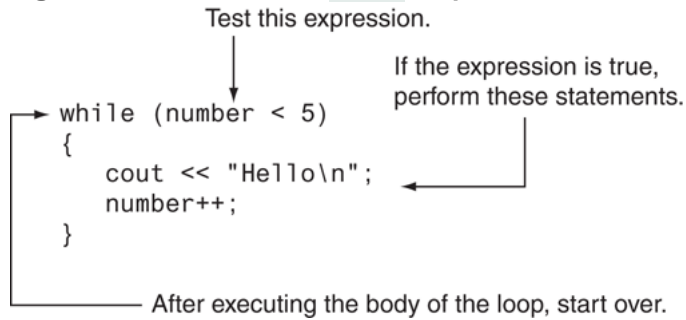
```
while (number < 5)
```

This statement tests the variable `number` to determine whether it is less than 5. If it is, then the statements in the body of the loop (lines 11 and 12) are executed:

```
cout << "Hello\n";  
number++;
```

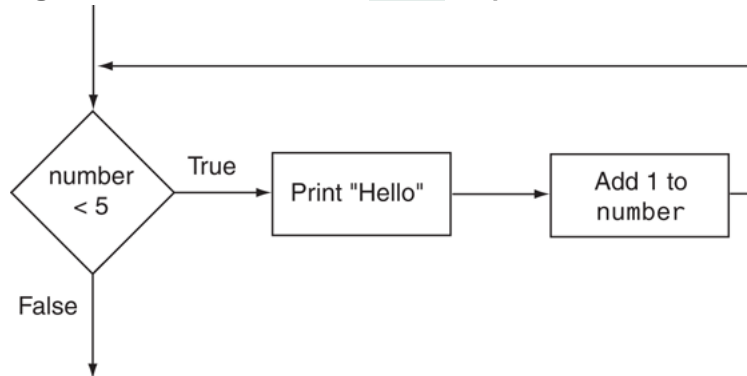
The statement in line 11 prints the word “Hello.” The statement in line 12 uses the increment operator to add one to `number`. This is the last statement in the body of the loop, so after it executes, the loop starts over. It tests the expression `number < 5` again, and if it is true, the statements in the body of the loop are executed again. This cycle repeats until the expression `number < 5` is false. This is illustrated in [Figure 5-2](#).

**Figure 5-2 Actions of the `while` loop**




Each repetition of a loop is known as an *iteration*. This loop will perform five iterations because the variable `number` is initialized with the value 0, and it is incremented each time the body of the loop is executed. When the expression `number < 5` is tested and found to be false, the loop will terminate and the program will resume execution at the statement that immediately follows the loop. [Figure 5-3](#) shows the logic of this loop.

**Figure 5-3 Flowchart for the `while` loop**



In this example, the `number` variable is referred to as the *loop control variable* because it controls the number of times that the loop iterates.

## The `while` Loop Is a Pretest Loop

The `while` loop is known as a *pretest* loop, which means it tests its expression before each iteration. Notice the variable definition in line 7 of [Program 5-3](#) .

```
int number = 0;
```

The `number` variable is initialized with the value 0. If `number` had been initialized with the value 5 or greater, as shown in the following program segment, the loop would never execute:

```
int number = 6;
while (number < 5)
{
    cout << "Hello\n";
    number++;
}
```

An important characteristic of the `while` loop is that the loop will never iterate if the test expression is false to start with. If you want to be sure that a `while` loop executes the first time, you must initialize the relevant data in such a way that the test expression starts out as true.



# Infinite Loops

In all but rare cases, loops must contain within themselves a way to terminate. This means that something inside the loop must eventually make the test expression false. The loop in [Program 5-3](#) stops when the expression `number < 5` is false.

If a loop does not have a way of stopping, it is called an infinite loop. An *infinite loop* continues to repeat until the program is interrupted. Here is an example of an infinite loop:

```
int number = 0;
while (number < 5)
{
    cout << "Hello\n";
}
```

This is an infinite loop because it does not contain a statement that changes the value of the `number` variable. Each time the expression `number < 5` is tested, `number` will contain the value 0.

It's also possible to create an infinite loop by accidentally placing a semicolon after the first line of the `while` loop. Here is an example:

```
int number = 0;
while (number < 5); // This semicolon is an ERROR!
{
    cout << "Hello\n";
    number++;
}
```

The semicolon at the end of the first line is assumed to be a null statement and disconnects the `while` statement from the block that comes after it. To the compiler, this loop looks like:

```
while (number < 5);
```

This `while` loop will forever execute the null statement, which does nothing. The program will appear to have “gone into space” because there is nothing to display screen output or show activity.

# Don't Forget the Braces with a Block of Statements

If you write a loop that conditionally executes a block of statements, don't forget to enclose all of the statements in a set of braces. If the braces are accidentally left out, the `while` statement conditionally executes only the very next statement. For example, look at the following code:

```
int number = 0;
// This loop is missing its braces!
while (number < 5)
    cout << "Hello\n";
    number++;
```

In this code, the `number++` statement is not in the body of the loop. Because the braces are missing, the `while` statement only executes the statement that immediately follows it. This loop will execute infinitely because there is no code in its body that changes the `number` variable.

Another common pitfall with loops is accidentally using the `=` operator when you intend to use the `==` operator. The following is an infinite loop because the test expression assigns 1 to `remainder` each time it is evaluated instead of testing whether `remainder` is equal to 1:

```
while (remainder = 1) // Error: Notice the assignment
{
    cout << "Enter a number: ";
    cin >> num;
    remainder = num % 2;
}
```

Remember, any nonzero value is evaluated as true.

# Programming Style and the `while` Loop

It's possible to create loops that look like this:

```
while (number < 5) { cout << "Hello\n"; number++; }
```

Avoid this style of programming. The programming style you should use with the `while` loop is similar to that of the `if` statement:

- If there is only one statement repeated by the loop, it should appear on the line after the `while` statement and be indented one additional level.
- If the loop repeats a block, each line inside the braces should be indented.

This programming style should visually set the body of the loop apart from the surrounding code. In general, you'll find a similar style being used with the other types of loops presented in this chapter.



## In the Spotlight:

### Designing a Program with a `while` Loop

A project currently underway at Chemical Labs, Inc. requires that a substance be continually heated in a vat. A technician must check the substance's temperature every 15 minutes. If the substance's temperature does not exceed 102.5 degrees Celsius, then the technician does nothing. However, if the temperature is greater than 102.5 degrees Celsius, the technician must turn down the vat's thermostat, wait 5 minutes, and check the temperature again. The technician repeats these steps until the temperature does not exceed 102.5 degrees Celsius. The director of engineering has asked you to write a program that guides the technician through this process.

Here is the algorithm:

1. Prompt the user to enter the substance's temperature.
2. Repeat the following steps as long as the temperature is greater than 102.5 degrees Celsius:
  - a. Tell the technician to turn down the thermostat, wait 5 minutes, and check the temperature again.
  - b. Prompt the user to enter the substance's temperature.
3. After the loop finishes, tell the technician that the temperature is acceptable and to check it again in 15 minutes.

After reviewing this algorithm, you realize that steps 2a and 2b should not be performed if the test condition (temperature is greater than 102.5) is false to begin with. The `while` loop will work well in this situation, because it will not execute even once if its condition is false. [Program 5-4](#) shows the code for the program.

## Program 5-4

```
1 // This program assists a technician in the process
2 // of checking a substance's temperature.
3 #include <iostream>
4 using namespace std;
5
6 int main()
7 {
8     const double MAX_TEMP = 102.5; // Maximum temperature
9     double temperature;           // To hold the temperature
10
11     // Get the current temperature.
12     cout << "Enter the substance's Celsius temperature: ";
13     cin >> temperature;
14
15     // As long as necessary, instruct the technician
16     // to adjust the thermostat.
17     while (temperature > MAX_TEMP)
18     {
19         cout << "The temperature is too high. Turn the\n";
20         cout << "thermostat down and wait 5 minutes.\n";
21         cout << "Then take the Celsius temperature again\n";
22         cout << "and enter it here: ";
23         cin >> temperature;
24     }
25
26     // Remind the technician to check the temperature
27     // again in 15 minutes.
28     cout << "The temperature is acceptable.\n";
29     cout << "Check it again in 15 minutes.\n";
30
31     return 0;
32 }
```

**Program Output with Example Input Shown in Bold**

Enter the substance's Celsius temperature: **104.7** Enter

The temperature is too high. Turn the thermostat down and wait 5 minutes.

Then take the Celsius temperature again

and enter it here: **103.2** Enter

The temperature is too high. Turn the thermostat down and wait 5 minutes.

Then take the Celsius temperature again

and enter it here: **102.1** Enter

The temperature is acceptable.

Check it again in 15 minutes.

## 5.3 Using the `while` Loop for Input Validation

### Concept:

The `while` loop can be used to create input routines that repeat until acceptable data is entered.

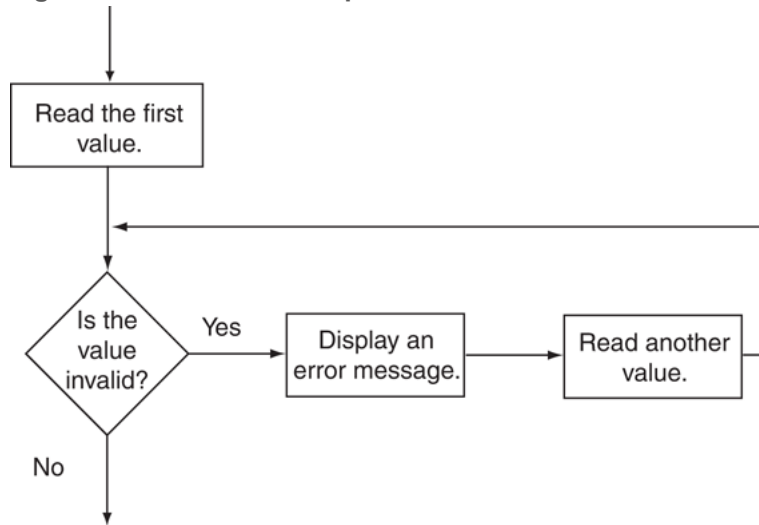
Perhaps the most famous saying of the computer industry is “garbage in, garbage out.” The integrity of a program’s output is only as good as its input, so you should try to make sure garbage does not go into your programs. *Input validation* is the process of inspecting data given to a program by the user and determining if it is valid. A good program should give clear instructions about the kind of input that is acceptable, and not assume the user has followed those instructions.

The `while` loop is especially useful for validating input. If an invalid value is entered, a loop can require that the user reenter it as many times as necessary. For example, the following loop asks for a number in the range of 1 through 100:


```
cout << "Enter a number in the range 1-100: ";
cin >> number;
while (number < 1 || number > 100)
{
    cout << "ERROR: Enter a value in the range 1-100: ";
    cin >> number;
}
```

This code first allows the user to enter a number. This takes place just before the loop. If the input is valid, the loop will not execute. If the input is invalid, however, the loop will display an error message and require the user to enter another number. The loop will continue to execute until the user enters a valid number. The general logic of performing input validation is shown in [Figure 5-4](#).

Figure 5-4 Flowchart for input validation



The read operation that takes place just before the loop is called a *priming read*. It provides the first value for the loop to test. Subsequent values are obtained by the loop.

**Program 5-5**  calculates the number of soccer teams a youth league may create, based on a given number of players and a maximum number of players per team. The program uses `while` loops (in lines 25 through 34 and lines 41 through 46) to validate the user's input.



## Program 5-5

```
1 // This program calculates the number of soccer teams
2 // that a youth league may create from the number of
3 // available players. Input validation is demonstrated
4 // with while loops.
5 #include <iostream>
6 using namespace std;
7
8 int main()
9 {
10     // Constants for minimum and maximum players
11     const int MIN_PLAYERS = 9,
12            MAX_PLAYERS = 15;
13
14     // Variables
15     int players, // Number of available players
16        teamPlayers, // Number of desired players per team
17        numTeams, // Number of teams
18        leftOver; // Number of players left over
19
20     // Get the number of players per team.
21     cout << "How many players do you wish per team? ";
22     cin >> teamPlayers;
23
24     // Validate the input.
25     while (teamPlayers < MIN_PLAYERS || teamPlayers > MAX_PLAYERS)
26     {
27         // Explain the error.
28         cout << "You should have at least " << MIN_PLAYERS
29              << " but no more than " << MAX_PLAYERS << " per team.\n";
30
31         // Get the input again.
32         cout << "How many players do you wish per team? ";
33         cin >> teamPlayers;
34     }
35
36     // Get the number of players available.
37     cout << "How many players are available? ";
```

```

38     cin >> players;
39
40     // Validate the input.
41     while (players <= 0)
42     {
43         // Get the input again.
44         cout << "Please enter 0 or greater: ";
45         cin >> players;
46     }
47
48     // Calculate the number of teams.
49     numTeams = players / teamPlayers;
50
51     // Calculate the number of leftover players.
52     leftOver = players % teamPlayers;
53
54     // Display the results.
55     cout << "There will be " << numTeams << " teams with "
56         << leftOver << " players left over.\n";
57     return 0;
58 }

```

### Program Output with Example Input Shown in Bold

```

How many players do you wish per team? 4 Enter
You should have at least 9 but no more than 15 per team.
How many players do you wish per team? 12 Enter
How many players are available? -142 Enter
Please enter 0 or greater: 142 Enter
There will be 11 teams with 10 players left over.

```



## Checkpoint

5.2 Write an input validation loop that asks the user to enter a number in the range of 10 through 25.


5.3 Write an input validation loop that asks the user to enter 'Y', 'y', 'N', or 'n'.

5.4 Write an input validation loop that asks the user to enter "Yes" or "No".

## 5.4 Counters

### **Concept:**

A counter is a variable that is regularly incremented or decremented each time a loop iterates.

Sometimes it's important for a program to control or keep track of the number of iterations a loop performs. For example, [Program 5-6](#)  displays a table consisting of the numbers 1 through 10 and their squares, so its loop must iterate 10 times.

## Program 5-6

```
1 // This program displays a list of numbers and
2 // their squares.
3 #include <iostream>
4 using namespace std;
5
6 int main()
7 {
8     const int MIN_NUMBER = 1, // Starting
number to square
9     MAX_NUMBER = 10; // Maximum
number to square
10
11     int num = MIN_NUMBER; // Counter
12
13     cout << "Number Number Squared\n";
14     cout << "-----\n";
15     while (num <= MAX_NUMBER)
16     {
17         cout << num << "\t\t" << (num * num)
<< endl;
18         num++; //Increment the counter.
19     }
```

```
20     return 0;
21 }
```

## Program Output

```
Number Number Squared
-----
1         1
2         4
3         9
4        16
5        25
6        36
7        49
8        64
9        81
10       100
```

In [Program 5-6](#), the variable `num`, which starts at 1, is incremented each time through the loop. When `num` reaches 11, the loop stops. `num` is used as a *counter* variable, which means it is regularly incremented in each iteration of the loop. In essence, `num` keeps count of the number of iterations the loop has performed.



## Note:

It's important that `num` be properly initialized. Remember, variables defined inside a function have no guaranteed starting value.

## 5.5 The `do-while` Loop

### Concept:

The `do-while` loop is a posttest loop, which means its expression is tested after each iteration.

The `do-while` loop looks something like an inverted `while` loop. Here is the `do-while` loop's format when the body of the loop contains only a single statement:

```
do
    statement;
while (expression);
```

Here is the format of the `do-while` loop when the body of the loop contains multiple statements:

```
do
{
    statement;
    statement;
    // Place as many statements here
    // as necessary.
} while (expression);
```



### Note:

The `do-while` loop must be terminated with a semicolon.

The `do-while` loop is a *posttest* loop. This means it does not test its expression until it has completed an iteration. As a result, the `do-while` loop always performs at least one iteration, even if the expression



is false to begin with. This differs from the behavior of a `while` loop, which you will recall is a pretest loop. For example, in the following `while` loop the `cout` statement will not execute at all:

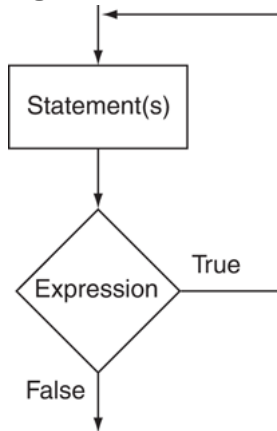
```
int x = 1;
while (x < 0)
    cout << x << endl;
```

But the `cout` statement in the following `do-while` loop will execute once because the `do-while` loop does not evaluate the expression `x < 0` until the end of the iteration.

```
int x = 1;
do
    cout << x << endl;
while (x < 0);
```

**Figure 5-5** illustrates the logic of the `do-while` loop.

**Figure 5-5** Flowchart for a `do-while` loop



You should use the `do-while` loop when you want to make sure the loop executes at least once. For example, **Program 5-7** averages a series of three test scores for a student. After the average is displayed, it asks the user if he or she wants to average another set of test scores. The program repeats as long as the user enters Y for yes.

## Program 5-7

```
1 // This program averages 3 test scores. It repeats as
2 // many times as the user wishes.
3 #include <iostream>
4 using namespace std;
5
6 int main()
7 {
8     int score1, score2, score3; // Three scores
9     double average;           // Average score
10    char again;                // To hold Y or N input
11
12    do
13    {
14        // Get three scores.
15        cout << "Enter 3 scores and I will average them: ";
16        cin >> score1 >> score2 >> score3;
17
18        // Calculate and display the average.
19        average = (score1 + score2 + score3) / 3.0;
20        cout << "The average is " << average << ".\n";
21
22        // Does the user want to average another set?
23        cout << "Do you want to average another set? (Y/N) ";
24        cin >> again;
25    } while (again == 'Y' || again == 'y');
26    return 0;
27 }
```

**Program Output with Example Input Shown in Bold**

```
Enter 3 scores and I will average them: 80 90 70 Enter
The average is 80.
Do you want to average another set? (Y/N) y Enter
Enter 3 scores and I will average them: 60 75 88 Enter
The average is 74.3333.
Do you want to average another set? (Y/N) n Enter
```

When this program was written, the programmer had no way of knowing the number of times the loop would iterate. This is because the loop asks the user if he or she wants to repeat the process. This type of loop is known as a *user-controlled loop*, because it allows the user to decide the number of iterations.

## Using `do-while` with Menus

The `do-while` loop is a good choice for repeating a menu. Recall Program 4-27, which displayed a menu of health club packages. [Program 5-8](#) is a modification of that program, which uses a `do-while` loop to repeat the program until the user selects item 4 from the menu.

## Program 5-8

```
1 // This program displays a menu and asks the user to make a
2 // selection. A do-while loop repeats the program until the
3 // user selects item 4 from the menu.
4 #include <iostream>
5 #include <iomanip>
6 using namespace std;
7
8 int main()
9 {
10     // Constants for menu choices
11     const int ADULT_CHOICE = 1,
12           CHILD_CHOICE = 2,
13           SENIOR_CHOICE = 3,
14           QUIT_CHOICE = 4;
15
16     // Constants for membership rates
17     const double ADULT = 40.0,
18           CHILD = 20.0,
19           SENIOR = 30.0;
20
21     // Variables
22     int choice; // Menu choice
23     int months; // Number of months
24     double charges; // Monthly charges
25
26     // Set up numeric output formatting.
27     cout << fixed << showpoint << setprecision(2);
28
29     do
30     {
31         // Display the menu.
32         cout << "\n\t\tHealth Club Membership Menu\n\n"
33              << "1. Standard Adult Membership\n"
34              << "2. Child Membership\n"
35              << "3. Senior Citizen Membership\n"
36              << "4. Quit the Program\n\n"
37              << "Enter your choice: ";
```

```

38     cin >> choice;
39
40     // Validate the menu selection.
41     while (choice < ADULT_CHOICE || choice > QUIT_CHOICE)
42     {
43         cout << "Please enter a valid menu choice: ";
44         cin >> choice;
45     }
46
47     // Process the user's choice.
48     if (choice != QUIT_CHOICE)
49     {
50         // Get the number of months.
51         cout << "For how many months? ";
52         cin >> months;
53
54         // Respond to the user's menu selection.
55         switch (choice)
56         {
57             case ADULT_CHOICE:
58                 charges = months * ADULT;
59                 break;
60             case CHILD_CHOICE:
61                 charges = months * CHILD;
62                 break;
63             case SENIOR_CHOICE:
64                 charges = months * SENIOR;
65         }
66
67         // Display the monthly charges.
68         cout << "The total charges are $"
69             << charges << endl;
70     }
71 } while (choice != QUIT_CHOICE);
72 return 0;
73 }

```

**Program Output with Example Input Shown in Bold**

```
Health Club Membership Menu
1. Standard Adult Membership
2. Child Membership
3. Senior Citizen Membership
4. Quit the Program
```

```
Enter your choice: 1 Enter
For how many months? 12 Enter
The total charges are $480.00
```

```
Health Club Membership Menu
1. Standard Adult Membership
2. Child Membership
3. Senior Citizen Membership
4. Quit the Program
Enter your choice: 4 Enter
```



## Checkpoint

5.5 What will the following program segments display?

- A. `int count = 10; do { cout << "Hello World\n"; count++; } while (count < 1);`
- B. `int v = 10; do cout << v << endl; while (v < 5);`
- C. `int count = 0, number = 0, limit = 4; do { number += 2; count++; } while (count < limit); cout << number << " " << count << endl;`

## 5.6 The `for` Loop

### Concept:

The `for` loop is ideal for performing a known number of iterations.

In general, there are two categories of loops: conditional loops and count-controlled loops. A *conditional loop* executes as long as a particular condition exists. For example, an input validation loop executes as long as the input value is invalid. When you write a conditional loop, you have no way of knowing the number of times it will iterate.



### The `for` Loop

Sometimes you know the exact number of iterations that a loop must perform. A loop that repeats a specific number of times is known as a *count-controlled* loop. For example, if a loop asks the user to enter the sales amounts for each month in the year, it will iterate 12 times. In essence, the loop counts to 12 and asks the user to enter a sales amount each time it makes a count. A count-controlled loop must possess three elements:

1. It must initialize a counter variable to a starting value.
2. It must test the counter variable by comparing it to a maximum value. When the counter variable reaches its maximum value, the loop terminates.
3. It must update the counter variable during each iteration. This is usually done by incrementing the variable.

Count-controlled loops are so common that C++ provides a type of loop specifically for them. It is known as the `for` loop. The `for` loop is specifically designed to initialize, test, and update a counter variable. Here is the format of the `for` loop when it is used to repeat a single statement:



```
for (initialization; test; update)
    statement;
```

The format of the `for` loop when it is used to repeat a block is

```
for (initialization; test; update)
{
    statement;
    statement;
    // Place as many statements here
    // as necessary.
}
```

The first line of the `for` loop is the *loop header*. After the key word `for`, there are three expressions inside the parentheses, separated by semicolons. (Notice there is not a semicolon after the third expression.) The first expression is the *initialization expression*. It is normally used to initialize a counter variable to its starting value. This is the first action performed by the loop, and it is only done once. The second expression is the *test expression*. This is an expression that controls the execution of the loop. As long as this expression is true, the body of the `for` loop will repeat. The `for` loop is a pretest loop, so it evaluates the test expression before each iteration. The third expression is the *update expression*. It executes at the end of each iteration. Typically, this is a statement that increments the loop's counter variable.

Here is an example of a simple `for` loop that prints "Hello" five times:

```
for (count = 0; count < 5; count++)
    cout << "Hello" << endl;
```


In this loop, the initialization expression is `count = 0`, the test expression is `count < 5`, and the update expression is `count++`. The body of the loop has one statement, which is the `cout` statement. **Figure 5-6**  illustrates the sequence of events that takes place during the loop's execution. Notice Steps 2 through 4 are repeated as long as the test expression is `true`.

Figure 5-6 Sequence of events in a `for` loop

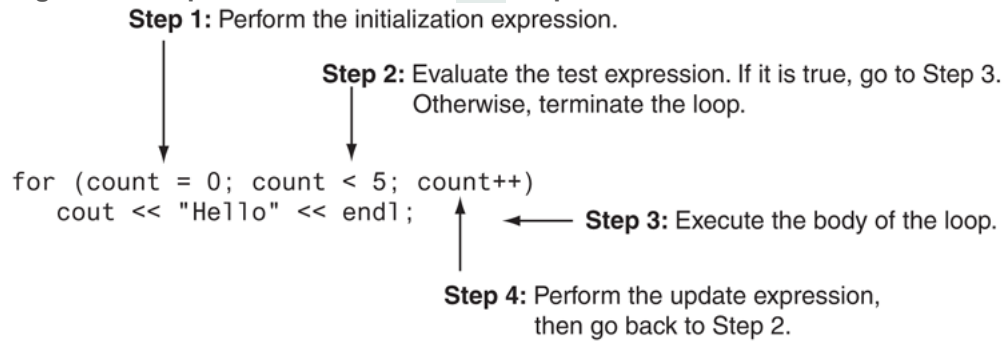



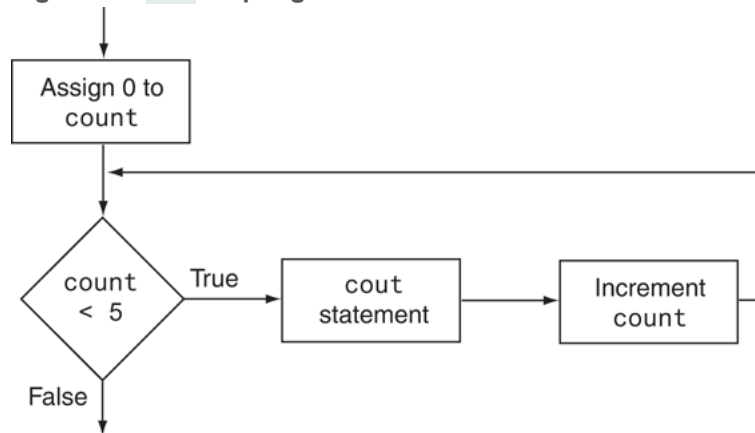
Figure 5-7  shows the loop's logic in the form of a flowchart.

Figure 5-7 `for` loop logic



Notice how the counter variable, `count`, is used to control the number of times that the loop iterates. During the execution of the loop, this variable takes on the values 1 through 5, and when the test expression `count < 5` is false, the loop terminates. Also notice in this example the `count` variable is used only in the loop header, to control the number of loop iterations. It is not used for any other purpose. It is also possible to use the counter variable within the body of the loop. For example, look at the following code:

```
for (number = 1; number <= 10; number++)  
    cout << number << " " << endl;
```

The counter variable in this loop is `number`. In addition to controlling the number of iterations, it is also used in the body of the loop. This loop will produce the following output:

```
1 2 3 4 5 6 7 8 9 10
```

As you can see, the loop displays the contents of the `number` variable during each iteration. **Program 5-9** shows another example of a `for` loop that uses its counter variable within the body of the loop. This is yet another program that displays a table showing the numbers 1 through 10 and their squares.

## Program 5-9

```
1 // This program displays the numbers 1 through 10 and
2 // their squares.
3 #include <iostream>
4 using namespace std;
5
6 int main()
7 {
8     const int MIN_NUMBER = 1, // Starting value
9           MAX_NUMBER = 10; // Ending value
10    int num;
11
12    cout << "Number Number Squared\n";
13    cout << "-----\n";
14
15    for (num = MIN_NUMBER; num <= MAX_NUMBER; num++)
16        cout << num << "\t\t" << (num * num) << endl;
17
18    return 0;
19 }
```

## Program Output

Number	Number Squared
1	1
2	4
3	9
4	16
5	25
6	36
7	49
8	64
9	81
10	100

Figure 5-8 illustrates the sequence of events performed by this `for` loop, and Figure 5-9 shows the logic of the loop as a flowchart.

Figure 5-8 Sequence of events in the `for` loop

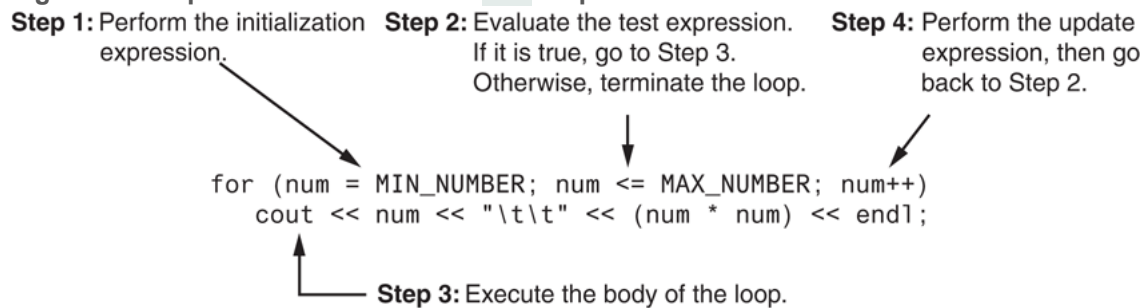
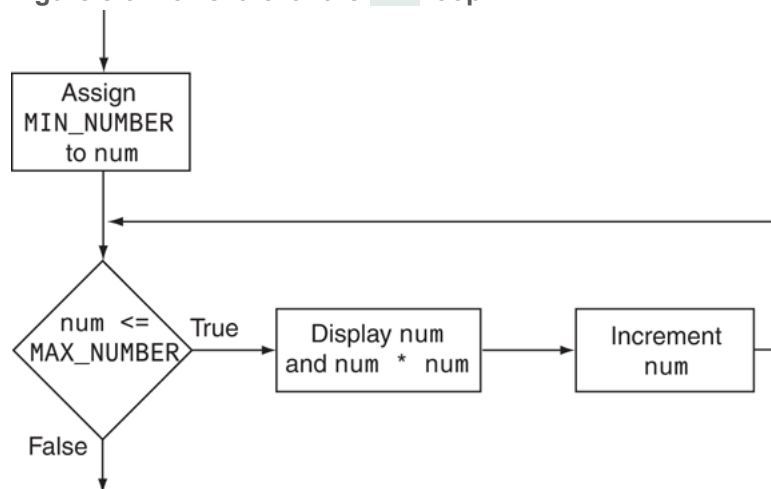


Figure 5-9 Flowchart for the `for` loop

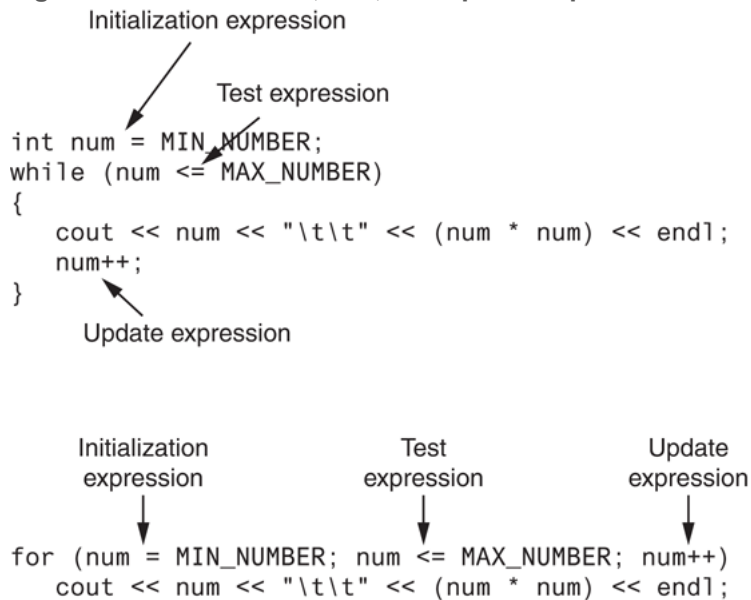


# Using the `for` Loop instead of `while` or `do-while`

You should use the `for` loop instead of the `while` or `do-while` loop in any situation that clearly requires an initialization, uses a false condition to stop the loop, and requires an update to occur at the end of each loop iteration. [Program 5-9](#) is a perfect example. It requires that the `num` variable be initialized to 1, it stops the loop when `num` is greater than 10, and it increments `num` at the end of each loop iteration.

Recall that when we first introduced the idea of a counter variable we examined [Program 5-6](#), which uses a `while` loop to display the table of numbers and their squares. Because the loop in that program requires an initialization, uses a false test expression to stop, and performs an increment at the end of each iteration, it can easily be converted to a `for` loop. [Figure 5-10](#) shows how the `while` loop in [Program 5-6](#) and the `for` loop in [Program 5-9](#) each have initialization, test, and update expressions.

**Figure 5-10 Initialization, test, and update expressions**



## The `for` Loop Is a Pretest Loop

Because the `for` loop tests its test expression before it performs an iteration, it is a pretest loop. It is possible to write a `for` loop in such a way that it will never iterate. Here is an example:

```
for (count = 11; count <= 10; count++)  
    cout << "Hello" << endl;
```

Because the variable `count` is initialized to a value that makes the test expression false from the beginning, this loop terminates as soon as it begins.

## Avoid Modifying the Counter Variable in the Body of the `for` Loop

Be careful not to place a statement that modifies the counter variable in the body of the `for` loop. All modifications of the counter variable should take place in the update expression, which is automatically executed at the end of each iteration. If a statement in the body of the loop also modifies the counter variable, the loop will probably not terminate when you expect it to. The following loop, for example, increments `x` twice for each iteration:

```
for (x = 1; x <= 10; x++)  
{  
    cout << x << endl;  
    x++; // Wrong!  
}
```

## Other Forms of the Update Expression

You are not limited to using increment statements in the update expression. Here is a loop that displays all the even numbers from 2 through 100 by adding 2 to its counter:

```
for (num = 2; num <= 100; num += 2)
    cout << num << endl;
```

And here is a loop that counts backward from 10 down to 0:

```
for (num = 10; num >= 0; num--)
    cout << num << endl;
```



## Defining a Variable in the `for` Loop's Initialization Expression

Not only may the counter variable be initialized in the initialization expression, it may be defined there as well. The following code shows an example. This is a modified version of the loop in [Program 5-9](#).

```
for (int num = MIN_NUMBER; num <= MAX_NUMBER; num++)  
    cout << num << "\t\t" << (num * num) << endl;
```

In this loop, the `num` variable is both defined and initialized in the initialization expression. If the counter variable is used only in the loop, it makes sense to define it in the loop header. This makes the variable's purpose more clear.

When a variable is defined in the initialization expression of a `for` loop, the scope of the variable is limited to the loop. This means you cannot access the variable in statements outside the loop. For example, the following program segment will not compile because the last `cout` statement cannot access the variable `count`.

```
for (int count = 1; count <= 10; count++)  
    cout << count << endl;  
cout << "count is now " << count << endl; // ERROR!
```

## Creating a User-Controlled `for` Loop

Sometimes you want the user to determine the maximum value of the counter variable in a `for` loop, and therefore determine the number of times the loop iterates. For example, look at [Program 5-10](#). This is another program that displays a list of numbers and their squares. Instead of displaying the numbers 1 through 10, this program allows the user to enter the minimum and maximum values to display.

## Program 5-10

```
1 // This program demonstrates a user-controlled for loop.
2 #include <iostream>
3 using namespace std;
4
5 int main()
6 {
7     int minNumber, // Starting number to square
8         maxNumber; // Maximum number to square
9
10    // Get the minimum and maximum values to display.
11    cout << "I will display a table of numbers and "
12         << "their squares.\n"
13         << "Enter the starting number: ";
14    cin >> minNumber;
15    cout << "Enter the ending number: ";
16    cin >> maxNumber;
17
18    // Display the table.
19    cout << "Number Number Squared\n"
20         << "-----\n";
21
22    for (int num = minNumber; num <= maxNumber; num++)
23        cout << num << "\t\t" << (num * num) << endl;
24
25    return 0;
26 }
```

**Program Output with Example Input Shown in Bold**

```
I will display a table of numbers and their squares.  
Enter the starting number: 6 Enter  
Enter the ending number: 12 Enter  
Number Number Squared  
-----  
6      36  
7      49  
8      64  
9      81  
10     100  
11     121  
12     144
```

Before the loop, the code in lines 11 through 16 asks the user to enter the starting and ending numbers. These values are stored in the `minNumber` and `maxNumber` variables. These values are used in the `for` loop's initialization and test expressions.

```
for (int num = minNumber; num <= maxNumber; num++)
```

In this loop, the `num` variable takes on the values from `minNumber` through `maxNumber`, and then the loop terminates.

# Using Multiple Statements in the Initialization and Update Expressions

It is possible to execute more than one statement in the initialization expression and the update expression. When using multiple statements in either of these expressions, simply separate the statements with commas. For example, look at the loop in the following code, which has two statements in the initialization expression:

```
int x, y;
for (x = 1, y = 1; x <= 5; x++)
{
    cout << x << " plus " << y
        << " equals " << (x + y)
        << endl;
}
```

This loop's initialization expression is

```
x = 1, y = 1
```

This initializes two variables, `x` and `y`. The output produced by this loop is

```
1 plus 1 equals 2
2 plus 1 equals 3
3 plus 1 equals 4
4 plus 1 equals 5
5 plus 1 equals 6
```

We can further modify the loop to execute two statements in the update expression. Here is an example:

```
int x, y;
for (x = 1, y = 1; x <= 5; x++, y++)
{
    cout << x << " plus " << y
        << " equals " << (x + y)
        << endl;
}
```

The loop's update expression is

```
x++, y++
```

This update expression increments both the `x` and `y` variables. The output produced by this loop is

```
1 plus 1 equals 2
2 plus 2 equals 4
3 plus 3 equals 6
4 plus 4 equals 8
5 plus 5 equals 10
```

Connecting multiple statements with commas works well in the initialization and update expressions, but do *not* try to connect multiple expressions this way in the test expression. If you wish to combine multiple expressions in the test expression, you must use the `&&` or `||` operators.

## Omitting the `for` Loop's Expressions

The initialization expression may be omitted from inside the `for` loop's parentheses if it has already been performed or no initialization is needed. Here is an example of the loop in [Program 5-10](#) with the initialization being performed prior to the loop:

```
int num = 1;
for ( ; num <= maxValue; num++)
    cout << num << "\t\t" << (num * num) << endl;
```

You may also omit the update expression if it is being performed elsewhere in the loop or if none is needed. Although this type of code is not recommended, the following `for` loop works just like a `while` loop:

```
int num = 1;
for ( ; num <= maxValue; )
{
    cout << num << "\t\t" << (num * num) << endl;
    num++;
}
```

You can even go so far as to omit all three expressions from the `for` loop's parentheses. Be warned, however, that if you leave out the test expression, the loop has no built-in way of terminating. Here is an example:

```
for ( ; ; )
    cout << "Hello World\n";
```

Because this loop has no way of stopping, it will display `"Hello World\n"` forever (or until something interrupts the program).



## In the Spotlight:


### Designing a Count-Controlled Loop with the `for` Statement

Your friend Amanda just inherited a European sports car from her uncle. Amanda lives in the United States, and she is afraid she will get a speeding ticket because the car's speedometer indicates kilometers per hour. She has asked you to write a program that displays a table of speeds in kilometers per hour with their values converted to miles per hour. The formula for converting kilometers per hour to miles per hour is:

$$MPH = KPH * 0.6214$$

In the formula, *MPH* is the speed in miles per hour and *KPH* is the speed in kilometers per hour.

The table your program displays should show speeds from 60 kilometers per hour through 130 kilometers per hour, in increments of 10, along with their values converted to miles per hour. The table should look something like this:

After thinking about this table of values, you decide that you will write a `for` loop that uses a counter variable to hold the kilometer-per-hour speeds. The counter's starting value will be 60, its ending value will be 130, and you will add 10 to the counter variable after each iteration. Inside the loop, you will use the counter variable to calculate a speed in miles per hour. [Program 5-11](#)  shows the code.



## Program 5-11

```
1 // This program converts the speeds 60 kph through
2 // 130 kph (in 10 kph increments) to mph.
3 #include <iostream>
4 #include <iomanip>
5 using namespace std;
6
7 int main()
8 {
9     // Constants for the speeds
10    const int START_KPH = 60, // Starting speed
11           END_KPH = 130, // Ending speed
12           INCREMENT = 10; // Speed increment
13
14    // Constant for the conversion factor
15    const double CONVERSION_FACTOR = 0.6214;
16
17    // Variables
18    int kph; // To hold speeds in kph
19    double mph; // To hold speeds in mph
20
21    // Set the numeric output formatting.
22    cout << fixed << showpoint << setprecision(1);
23
24    // Display the table headings.
25    cout << "KPH\tMPH\n";
26    cout << "-----\n";
27
28    // Display the speeds.
29    for (kph = START_KPH; kph <= END_KPH; kph += INCREMENT)
30    {
31        // Calculate mph
32        mph = kph * CONVERSION_FACTOR;
33
34        // Display the speeds in kph and mph.
35        cout << kph << "\t" << mph << endl;
36
37    }
```

```
38     return 0;
39 }
```

### Program Output

KPH	MPH
60	37.3
70	43.5
80	49.7
90	55.9
100	62.1
110	68.4
120	74.6
130	80.8



## Checkpoint

5.6 Name the three expressions that appear inside the parentheses in the `for` loop's header.

5.7 You want to write a `for` loop that displays "I love to program" 50 times. Assume you will use a counter variable named `count`.

- A. What initialization expression will you use?
- B. What test expression will you use?
- C. What update expression will you use?
- D. Write the loop.

5.8 What will the following program segments display?

- A. `for (int count = 0; count < 6; count++) cout << (count + count);`
- B. `for (int value = -5; value < 5; value++) cout << value;`
- C. `int x; for (x = 5; x <= 14; x += 3) cout << x << endl; cout << x << endl;`

5.9 Write a `for` loop that displays your name 10 times.

5.10 Write a `for` loop that displays all of the odd numbers, 1 through 49.

5.11 Write a `for` loop that displays every fifth number, 0 through 100.

## 5.7 Keeping a Running Total

### Concept:

A *running total* is a sum of numbers that accumulates with each iteration of a loop. The variable used to keep the running total is called an *accumulator*.

Many programming tasks require you to calculate the total of a series of numbers. For example, suppose you are writing a program that calculates a business's total sales for a week. The program would read the sales for each day as input and calculate the total of those numbers.

Programs that calculate the total of a series of numbers typically use two elements:

1. A loop that reads each number in the series.
2. A variable that accumulates the total of the numbers as they are read.


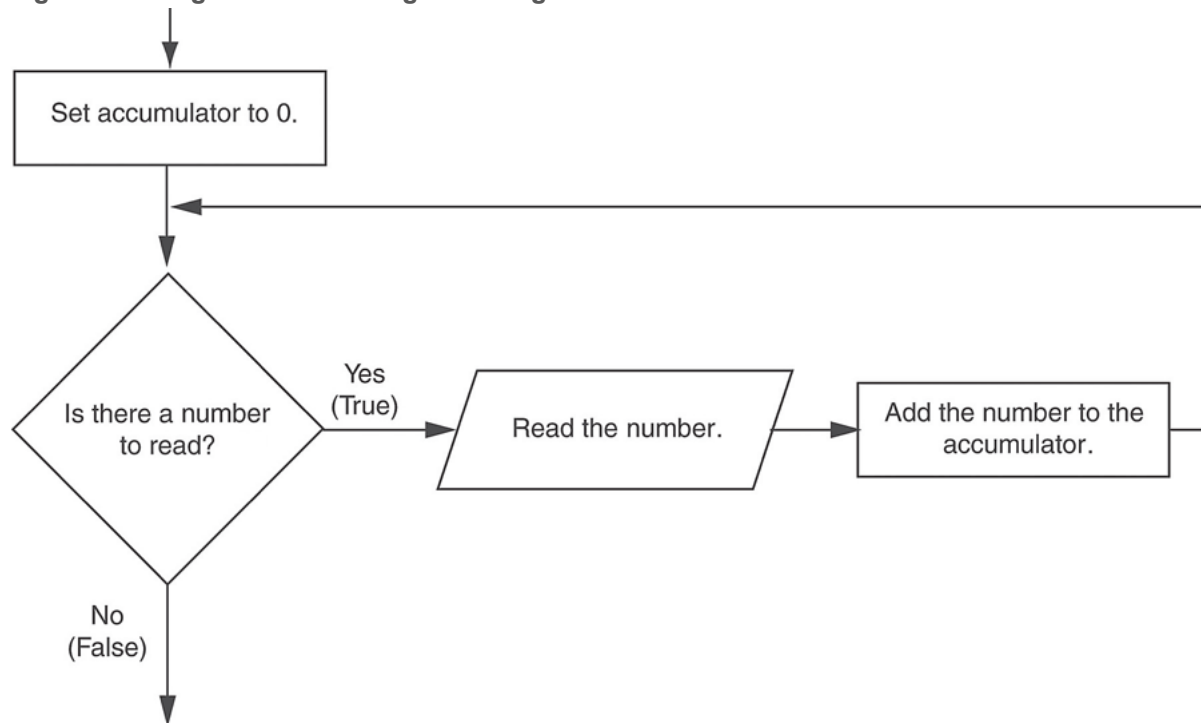
The variable that is used to accumulate the total of the numbers is called an *accumulator*. It is often said that the loop keeps a *running total* because it accumulates the total as it reads each number in the series. [Figure 5-11](#)  shows the general logic of a loop that calculates a running total.

Figure 5-11 Logic for calculating a running total



When the loop finishes, the accumulator will contain the total of the numbers that were read by the loop. Notice the first step in the flowchart is to set the accumulator variable to 0. This is a critical step. Each time the loop reads a number, it adds it to the accumulator. If the accumulator starts with any value other than 0, it will not contain the correct total when the loop finishes.

Let's look at a program that calculates a running total. [Program 5-12](#) calculates a company's total sales over a period of time by taking daily sales figures as input and calculating a running total of them as they are gathered.

## Program 5-12

```
1 // This program takes daily sales amounts over a period of time
2 // and calculates their total.
3 #include <iostream>
4 #include <iomanip>
5 using namespace std;
6
7 int main()
8 {
9     int days;           // Number of days
10    double total = 0.0; // Accumulator, initialized with 0
11
12    // Get the number of days.
13    cout << "For how many days do you have sales amounts? ";
14    cin >> days;
15
16    // Get the sales for each day and accumulate a total.
17    for (int count = 1; count <= days; count++)
18    {
19        double sales;
20        cout << "Enter the sales for day " << count << ": ";
21        cin >> sales;
22        total += sales; // Accumulate the running total.
23    }
24
25    // Display the total sales.
26    cout << fixed << showpoint << setprecision(2);
27    cout << "The total sales are $" << total << endl;
28    return 0;
29 }
```

**Program Output with Example Input Shown in Bold**

```
For how many days do you have sales amounts? 5 Enter
Enter the sales for day 1: 489.32 Enter
Enter the sales for day 2: 421.65 Enter
Enter the sales for day 3: 497.89 Enter
Enter the sales for day 4: 532.37 Enter
Enter the sales for day 5: 506.92 Enter
The total sales are $2448.15
```

Let's take a closer look at this program. Line 9 defines the `days` variable, which will hold the number of days for which we have sales figures. Line 10 defines the `total` variable, which will hold the total sales. Because `total` is an accumulator, it is initialized with 0.0.

In line 14, the user enters the number of days for which he or she has sales amounts. The number is assigned to the `days` variable. Next, the `for` loop in lines 17 through 23 executes. In the loop's initialization expression, in line 17, the variable `count` is defined and initialized with 1. The test expression specifies the loop will repeat as long as `count` is less than or equal to `days`. The update expression increments `count` by one at the end of each loop iteration.


Line 19 defines a variable named `sales`. Because the variable is defined in the body of the loop, its scope is limited to the loop. During each loop iteration, the user enters the amount of sales for a specific day, which is assigned to the `sales` variable. This is done in line 21. Then, in line 22, the value of `sales` is added to the existing value in the `total` variable. (Note line 22 does *not* assign `sales` to `total`, but *adds* `sales` to `total`. Put another way, this line increases `total` by the amount in `sales`.)

Because `total` was initially assigned 0.0, after the first iteration of the loop, `total` will be set to the same value as `sales`. After each subsequent iteration, `total` will be increased by the amount in `sales`. After the loop has finished, `total` will contain the total of all the daily sales figures entered. Now it should be clear why we assigned 0.0 to `total` before the loop executed. If `total` started at any other value, the total would be incorrect.


## 5.8 Sentinels

### Concept:

A *sentinel* is a special value that marks the end of a list of values.

**Program 5-12** , in the previous section, requires the user to know in advance the number of days for which he or she wishes to enter sales figures. Sometimes, the user has a list that is very long and doesn't know how many items there are. In other cases, the user might be entering several lists, and it is impractical to require that every item in every list be counted.

A technique that can be used in these situations is to ask the user to enter a sentinel at the end of the list. A *sentinel* is a special value that cannot be mistaken as a member of the list and signals that there are no more values to be entered. When the user enters the sentinel, the loop terminates.

**Program 5-13**  calculates the total points earned by a soccer team over a series of games. It allows the user to enter the series of game points, then  $-1$  to signal the end of the list.

## Program 5-13

```
1 // This program calculates the total number of
points a
2 // soccer team has earned over a series of
games. The user
3 // enters a series of point values, then -1
when finished.
4 #include <iostream>
5 using namespace std;
6
7 int main()
8 {
9     int game = 1, // Game counter
10     points, // To hold a number of
points
11     total = 0; // Accumulator
12
13     cout << "Enter the number of points your
team has earned\n";
14     cout << "so far in the season, then enter
-1 when finished.\n\n";
15     cout << "Enter the points for game " <<
game << ": ";
16     cin >> points;
```



```
17
18     while (points != -1)
19     {
20         total += points;
21         game++;
22         cout << "Enter the points for game "
23         << game << ": ";
24         cin >> points;
25     }
26     cout << "\nThe total points are " << total
27     << endl;
28     return 0;
29 }
```

**Program Output with Example Input Shown in Bold**

```
Enter the number of points your team has
earned
so far in the season, then enter -1 when
finished.
```

```
Enter the points for game 1: 7 Enter
Enter the points for game 2: 9 Enter
Enter the points for game 3: 4 Enter
Enter the points for game 4: 6 Enter
Enter the points for game 5: 8 Enter
Enter the points for game 6: -1 Enter
```

```
The total points are 34
```

The value  $-1$  was chosen for the sentinel in this program because it is not possible for a team to score negative points. Notice this program performs a priming read in line 18 to get the first value. This makes it possible for the loop to immediately terminate if the user enters  $-1$  as the first value. Also note the sentinel value is not included in the running total.

## Checkpoint

5.12 Write a `for` loop that repeats seven times, asking the user to enter a number. The loop should also calculate the sum of the numbers entered.

5.13 In the following program segment, which variable is the counter variable and which is the accumulator?

```
int a, x, y = 0;
for (x = 0; x < 10; x++)
{
    cout << "Enter a number: ";
    cin >> a;
    y += a;
}
cout << "The sum of those numbers is " << y << endl;
```

5.14 Why should you be careful when choosing a sentinel value?

5.15 How would you modify [Program 5-13](#)  so any negative value is a sentinel?

# 5.9 Focus on Software Engineering: Deciding Which Loop to Use

## Concept:

Although most repetitive algorithms can be written with any of the three types of loops, each works best in different situations.

Each of the three C++ loops is ideal to use in different situations. Here's a short summary of when each loop should be used:

- **The while loop.** The `while` loop is a conditional loop, which means it repeats as long as a particular condition exists. It is also a pretest loop, so it is ideal in situations where you do not want the loop to iterate if the condition is false from the beginning. For example, validating input that has been read and reading lists of data terminated by a sentinel value are good applications of the `while` loop.

- **The do-while loop.** The `do-while` loop is also a conditional loop. Unlike the `while` loop, however, `do-while` is a posttest loop. It is ideal in situations where you always want the loop to iterate at least once. The `do-while` loop is a good choice for repeating a menu.
- **The for loop.** The `for` loop is a pretest loop that has built-in expressions for initializing, testing, and updating. These expressions make it very convenient to use a counter variable to control the number of iterations that the loop performs. The initialization expression can initialize the counter variable to a starting value, the test expression can test the counter variable to determine whether it holds the maximum value, and the update expression can increment the counter variable. The `for` loop is ideal in situations where the exact number of iterations is known.

## 5.10 Nested Loops

### Concept:

A loop that is inside another loop is called a *nested loop*.

A nested loop is a loop that appears inside another loop. A clock is a good example of something that works like a nested loop. The second hand, minute hand, and hour hand all spin around the face of the clock. Each time the hour hand increments, the minute hand increments 60 times. Each time the minute hand increments, the second hand increments 60 times.

Here is a program segment with a `for` loop that partially simulates a digital clock. It displays the seconds from 0 to 59.

```
cout << fixed << right;  
cout.fill('0');  
for (int seconds = 0; seconds < 60; seconds++)  
    cout << setw(2) << seconds << endl;
```



## Note:

The `fill` member function of `cout` changes the fill character, which is a space by default. In the program segment above, the `fill` function causes a zero to be printed in front of all single digit numbers.

We can add a `minutes` variable and nest the loop above inside another loop that cycles through 60 minutes.

```
cout << fixed << right;
cout.fill('0');
for (int minutes = 0; minutes < 60; minutes++)
{
    for (int seconds = 0; seconds < 60; seconds++)
    {
        cout << setw(2) << minutes << ":";
        cout << setw(2) << seconds << endl;
    }
}
```

To make the simulated clock complete, another variable and loop can be added to count the hours.

```
cout << fixed << right;
cout.fill('0');
for (int hours = 0; hours < 24; hours++)
{
    for (int minutes = 0; minutes < 60; minutes++)
    {
        for (int seconds = 0; seconds < 60; seconds++)
        {
            cout << setw(2) << hours << ":";
            cout << setw(2) << minutes << ":";
            cout << setw(2) << seconds << endl;
        }
    }
}
```

The output of the previous program segment follows:




```
00:00:00
00:00:01
00:00:02
. (The program will count through each second of 24
hours.)
.
.
23:59:59
```

The innermost loop will iterate 60 times for each iteration of the middle loop. The middle loop will iterate 60 times for each iteration of the outermost loop. When the outermost loop has iterated 24 times, the middle loop will have iterated 1,440 times and the innermost loop will have iterated 86,400 times!

The simulated clock example brings up a few points about nested loops:

- An inner loop goes through all of its iterations for each iteration of an outer loop.
- Inner loops complete their iterations faster than outer loops.
- To get the total number of iterations of a nested loop, multiply the number of iterations of all the loops.

**Program 5-14**  is another test-averaging program. It asks the user for the number of students and the number of test scores per student. A nested inner loop, in lines 26 through 33, asks for all the

test scores for one student, iterating once for each test score. The outer loop in lines 23 through 37 iterates once for each student.

## Program 5-14

```
1 // This program averages test scores. It asks
the user for the
2 // number of students and the number of test
scores per student.
3 #include <iostream>
4 #include <iomanip>
5 using namespace std;
6
7 int main()
8 {
9     int numStudents, // Number of students
10        numTests;    // Number of tests per
student
11    double total,    // Accumulator for
total scores
12           average; // Average test score
13
14    // Set up numeric output formatting.
15    cout << fixed << showpoint <<
setprecision(1);
16
17    // Get the number of students.
18    cout << "This program averages test
```

```
scores.\n";  
19     cout << "For how many students do you have  
scores? ";  
20     cin >> numStudents;  
21  
22     // Get the number of test scores per  
student.  
23     cout << "How many test scores does each  
student have? ";  
24     cin >> numTests;  
25  
26     // Determine each student's average score.  
27     for (int student = 1; student <=  
numStudents; student++)  
28     {  
29         total = 0; // Initialize the  
accumulator.  
30         for (int test = 1; test <= numTests;  
test++)  
31         {  
32             double score;  
33             cout << "Enter score " << test <<  
" for ";  
34             cout << "student " << student <<  
": ";  
35             cin >> score;  
36             total += score;
```

```
37         }  
38         average = total / numTests;  
39         cout << "The average score for student  
" << student;  
40         cout << " is " << average << ".\n\n";  
41     }  
42     return 0;  
43 }
```

**Program Output with Example Input Shown in Bold**

This program averages test scores.

For how many students do you have scores? **2**

Enter

How many test scores does each student have?

**3** Enter

Enter score 1 for student 1: **84** Enter

Enter score 2 for student 1: **79** Enter

Enter score 3 for student 1: **97** Enter

The average score for student 1 is 86.7.

Enter score 1 for student 2: **92** Enter

Enter score 2 for student 2: **88** Enter

Enter score 3 for student 2: **94** Enter

The average score for student 2 is 91.3.

## 5.11 Using Files for Data Storage

### Concept:

When a program needs to save data for later use, it writes the data in a file. The data can then be read from the file at a later time.

The programs you have written so far require the user to reenter data each time the program runs, because data kept in variables and control properties is stored in RAM and disappears once the program stops running. If a program is to retain data between the times it runs, it must have a way of saving it. Data is saved in a file, which is usually stored on a computer's disk. Once the data is saved in a file, it will remain there after the program stops running. Data stored in a file can be then retrieved and used at a later time.

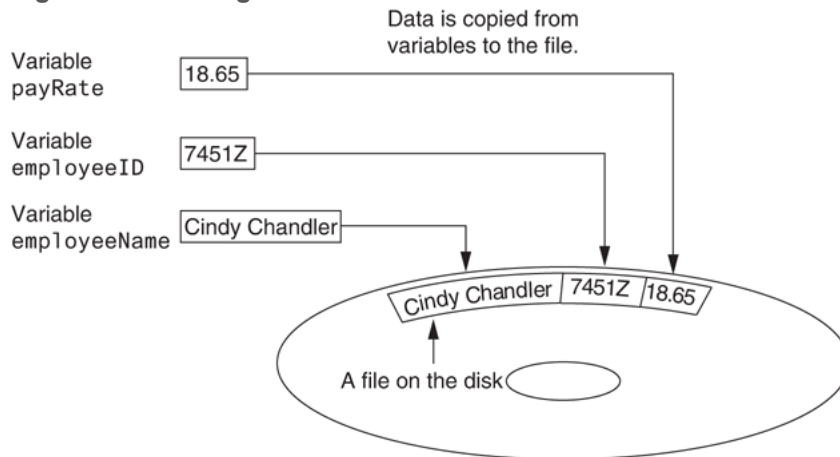
Most of the commercial software that you use on a day-to-day basis store data in files. The following are a few examples:

- **Word processors:** Word processing programs are used to write letters, memos, reports, and other documents. The documents are then saved in files so they can later be edited and printed.
- **Image editors:** Image editing programs are used to draw graphics and edit images such as the ones that you take with a digital camera. The images that you create or edit with an image editor are saved in files.
- **Spreadsheets:** Spreadsheet programs are used to work with numerical data. Numbers and mathematical formulas can be inserted into the rows and columns of the spreadsheet. The spreadsheet can then be saved in a file for later use.
- **Games:** Many computer games keep data stored in files. For example, some games keep a list of players' names with their scores stored in a file. These games typically display the players' names in order of their scores, from highest to lowest. Some games also allow you to save your current game status in a file so you can quit the game then resume playing it later without having to start from the beginning.
- **Web browsers:** Sometimes when you visit a webpage, the browser stores a small file known as a *cookie* on your computer. Cookies typically contain information about the browsing session, such as the contents of a shopping cart.

Programs used in daily business operations rely extensively on files. Payroll programs keep employee data in files, inventory programs keep data about a company's products in files, accounting systems keep data about a company's financial operations in files, and so on.

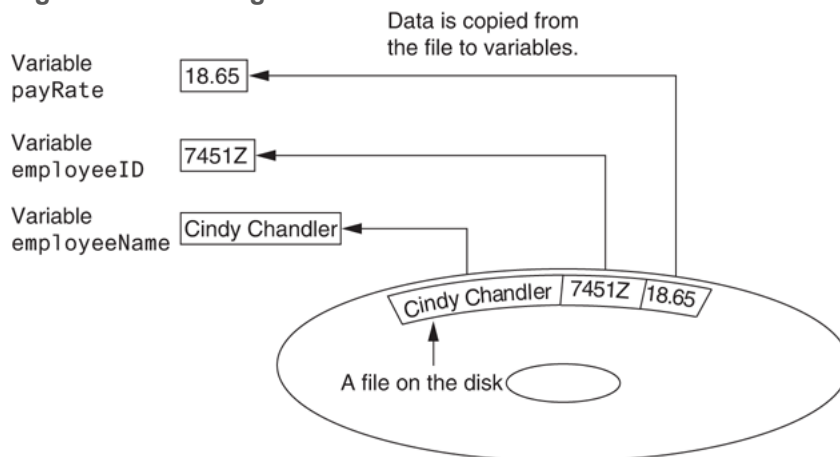
Programmers usually refer to the process of saving data in a file as *writing data* to the file. When a piece of data is written to a file, it is copied from a variable in RAM to the file. This is illustrated in [Figure 5-12](#). An *output file* is a file to which data is written. It is called an output file because the program stores output in it.

**Figure 5-12 Writing data to a file**



The process of retrieving data from a file is known as *reading data* from the file. When a piece of data is read from a file, it is copied from the file into a variable in RAM. [Figure 5-13](#) illustrates this process. An *input file* is a file from which data is read. It is called an input file because the program gets input from the file.

**Figure 5-13 Reading data from a file**



This section discusses ways to create programs that write data to files and read data from files. When a file is used by a program, three steps must be taken.

1. **Open the file**—Opening a file creates a connection between the file and the program. Opening an output file usually creates the file on the disk, and allows the program to write data to it. Opening an input file allows the program to read data from the file.



2. **Process the file**—Data is either written to the file (if it is an output file) or read from the file (if it is an input file).
3. **Close the file**—After the program is finished using the file, the file must be closed. Closing a file disconnects the file from the program.

## Types of Files

In general, there are two types of files: text and binary. A *text file* contains data that has been encoded as text, using a scheme such as ASCII or Unicode. Even if the file contains numbers, those numbers are stored in the file as a series of characters. As a result, the file may be opened and viewed in a text editor such as Notepad. A *binary file* contains data that has not been converted to text. Thus, you cannot view the contents of a binary file with a text editor. In this chapter, we work only with text files. In [Chapter 12](#), you will learn to work with binary files.

## File Access Methods

There are two general ways to access data stored in a file: sequential access and direct access. When you work with a *sequential-access file*, you access data from the beginning of the file to the end of the file. If you want to read a piece of data that is stored at the very end of the file, you have to read all of the data that comes before it—you cannot jump directly to the desired data. This is similar to the way that older cassette tape players work. If you want to listen to the last song on a cassette tape, you have to either fast-forward over all of the songs that come before it or listen to them. There is no way to jump directly to a specific song.

When you work with a *random-access file* (also known as a *direct access file*), you can jump directly to any piece of data in the file without reading the data that comes before it. This is similar to the way a CD player or an MP3 player works. You can jump directly to any song that you want to hear.

This chapter focuses on sequential-access files. Sequential-access files are easy to work with, and you can use them to gain an understanding of basic file operations. In [Chapter 12](#), you will learn to work with random-access files.

# Filenames and File Stream Objects

Files on a disk are identified by a *filename*. For example, when you create a document with a word processor then save the document in a file, you have to specify a filename. When you use a utility such as Windows Explorer to examine the contents of your disk, you see a list of filenames. [Figure 5-14](#) shows how three files named `cat.jpg`, `notes.txt`, and `resume.doc` might be represented in Windows Explorer.

**Figure 5-14 Three files**



Each operating system has its own rules for naming files. Many systems, including Windows, support the use of *filename extensions*, which are short sequences of characters that appear at the end of a filename preceded by a period (known as a “dot”). For example, the files depicted in [Figure 5-14](#) have the extensions `.jpg`, `.txt`, and `.doc`. The extension usually indicates the type of data stored in the file. For example, the `.jpg` extension usually indicates that the file contains a graphic image that is compressed according to the JPEG image standard. The `.txt` extension usually indicates that the file contains text. The `.doc` extension usually indicates that the file contains a Microsoft Word document.

In order for a program to work with a file on the computer’s disk, the program must create a file stream object in memory. A *file stream object* is an object that is associated with a specific file and provides a way for the program to work with that file. It is called a “stream” object because a file can be thought of as a stream of data.

File stream objects work very much like the `cin` and `cout` objects. A stream of data may be sent to `cout`, which causes values to be displayed on the screen. A stream of data may be read from the keyboard by `cin`, and stored in variables. Likewise, streams of data may be sent to a file stream object, which writes the data to a file. When data is read from a file, the data flows from the file stream object that is associated with the file into variables.

# Setting Up a Program for File Input/Output

Just as `cin` and `cout` require the `iostream` file to be included in the program, C++ file access requires another header file. The file `<fstream>` contains all the declarations necessary for file operations. It is included with the following statement:

```
#include <fstream>
```

The `<fstream>` header file defines the data types `ofstream`, `ifstream`, and `fstream`. Before a C++ program can work with a file, it must define an object of one of these data types. The object will be “linked” with an actual file on the computer’s disk, and the operations that may be performed on the file depend on which of these three data types you pick for the file stream object. [Table 5-1](#) lists and describes the file stream data types.

**Table 5-1 File Stream Objects**



**Note:**

In this chapter, we discuss only the `ofstream` and `ifstream` types. The `fstream` type will be covered in [Chapter 12](#).

# Creating a File Object and Opening a File

Before data can be written to or read from a file, the following things must happen:

- A file stream object must be created.
- The file must be opened and linked to the file stream object.

The following code shows an example of opening a file for input (reading).

```
ifstream inputFile;  
inputFile.open("Customers.txt");
```

The first statement defines an `ifstream` object named `inputFile`. The second statement calls the object's `open` member function, passing the string `"Customers.txt"` as an argument. In this statement, the `open` member function opens the `Customers.txt` file and links it with the `inputFile` object. After this code executes, you will be able to use the `inputFile` object to read data from the `Customers.txt` file.

The following code shows an example of opening a file for output (writing).

```
ofstream outputFile;  
outputFile.open("Employees.txt");
```

The first statement defines an `ofstream` object named `outputFile`. The second statement calls the object's `open` member function, passing the string `"Employees.txt"` as an argument. In this statement, the `open` member function creates the `Employees.txt` file and links it with the `outputFile` object. After this code executes, you will be able to use the `outputFile` object to write data to the `Employees.txt` file. It's important to remember that when you call an `ofstream` object's `open` member function, the specified file will be created. If the specified file already exists, it will be deleted, and a new file with the same name will be created.

Often, when opening a file, you will need to specify its path as well as its name. For example, on a Windows system the following statement opens the file `C:\data\inventory.txt`:

```
inputFile.open("C:\\data\\inventory.txt")
```

In this statement, the file `C:\data\inventory.txt` is opened and linked with `inputFile`.



### Note:

Notice the use of two backslashes in the file's path. Two backslashes are needed to represent one backslash in a string literal.

It is possible to define a file stream object and open a file in one statement. Here is an example:

```
ifstream inputFile("Customers.txt");
```

This statement defines an `ifstream` object named `inputFile` and opens the `Customer.txt` file. Here is an example that defines an `ofstream` object named `outputFile` and opens the `Employees.txt` file:

```
ofstream outputFile("Employees.txt");
```

## Closing a File

The opposite of opening a file is closing it. Although a program's files are automatically closed when the program shuts down, it is a good programming practice to write statements that close them. Here are two reasons a program should close files when it is finished using them:

1. Most operating systems temporarily store data in a *file buffer* before it is written to a file. A file buffer is a small "holding section" of memory to which file-bound data is first written. When the buffer is filled, all the data stored there is written to the file. This technique improves the system's performance. Closing a file causes any unsaved data that may still be held in a buffer to be saved to its file. This means the data will be in the file if you need to read it later in the same program.
2. Some operating systems limit the number of files that may be open at one time. When a program closes files that are no longer being used, it will not deplete more of the operating system's resources than necessary.

Calling the file stream object's `close` member function closes a file. Here is an example:

```
inputFile.close();
```

# Writing Data to a File



You already know how to use the stream insertion operator (<<) with the `cout` object to write data to the screen. It can also be used with `ofstream` objects to write data to a file. Assuming `outputFile` is an `ofstream` object, the following statement demonstrates using the << operator to write a string literal to a file:

```
outputFile << "I love C++ programming\n";
```

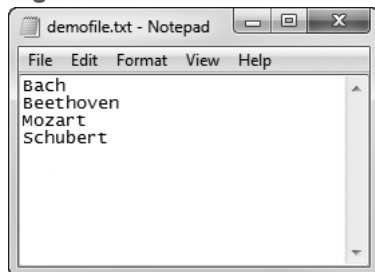
This statement writes the string literal `"I love C++ programming\n"` to the file associated with `outputFile`. As you can see, the statement looks like a `cout` statement, except the name of the `ofstream` object name replaces `cout`. Here is a statement that writes both a string literal and the contents of a variable to a file:

```
outputFile << "Price: " << price << endl;
```

The statement above writes the stream of data to `outputFile` exactly as `cout` would write it to the screen: It writes the string `"Price: "`, followed by the value of the `price` variable, followed by a newline character.

**Program 5-15**  demonstrates opening a file, writing data to the file, and closing the file. After this code has executed, we can open the `demofile.txt` file using a text editor and look at its contents. **Figure 5-15**  shows how the file's contents will appear in Notepad.

**Figure 5-15 Contents of demofile.txt**



## Program 5-15

```
1 // This program writes data to a file.
2 #include <iostream>
3 #include <fstream>
4 using namespace std;
5
6 int main()
7 {
8     ofstream outputFile;
9     outputFile.open("demofile.txt");
10
11     cout << "Now writing data to the file.\n";
12
13     // Write four names to the file.
14     outputFile << "Bach\n";
15     outputFile << "Beethoven\n";
16     outputFile << "Mozart\n";
17     outputFile << "Schubert\n";
18
19     // Close the file
20     outputFile.close();
21     cout << "Done.\n";
22     return 0;
23 }
```

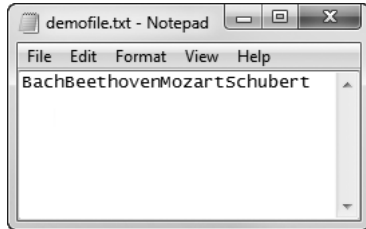
### Program Screen Output

```
Now writing data to the file.
Done.
```

Notice in lines 14 through 17 of [Program 5-15](#), each string that was written to the file ends with a newline escape sequence (`\n`). The newline specifies the end of a line of text. Because a newline is written at the end of each string, the strings appear on separate lines when viewed in a text editor, as shown in [Figure 5-15](#).

**Program 5-16** shows what happens if we write the same four names without the `\n` escape sequence. **Figure 5-16** shows the contents of the file that **Program 5-16** creates. As you can see, all of the names appear on the same line in the file.

**Figure 5-16** Output written as one line






## Program 5-16

```
1 // This program writes data to a single line in a file.
2 #include <iostream>
3 #include <fstream>
4 using namespace std;
5
6 int main()
7 {
8     ofstream outputFile;
9     outputFile.open("demofile.txt");
10
11     cout << "Now writing data to the file.\n";
12
13     // Write four names to the file.
14     outputFile << "Bach";
15     outputFile << "Beethoven";
16     outputFile << "Mozart";
17     outputFile << "Schubert";
18
19     // Close the file
20     outputFile.close();
21     cout << "Done.\n";
22     return 0;
23 }
```

### Program Screen Output

```
Now writing data to the file.
Done.
```

**Program 5-17**  shows another example. This program reads three numbers from the keyboard as input then saves those numbers in a file named Numbers.txt.

## Program 5-17

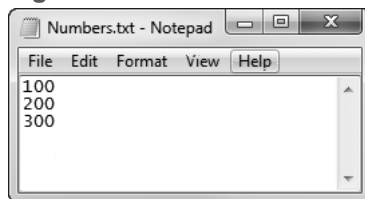
```
1 // This program writes user input to a file.
2 #include <iostream>
3 #include <fstream>
4 using namespace std;
5
6 int main()
7 {
8     ofstream outputFile;
9     int number1, number2, number3;
10
11     // Open an output file.
12     outputFile.open("Numbers.txt");
13
14     // Get three numbers from the user.
15     cout << "Enter a number: ";
16     cin >> number1;
17     cout << "Enter another number: ";
18     cin >> number2;
19     cout << "One more time. Enter a number: ";
20     cin >> number3;
21
22     // Write the numbers to the file.
23     outputFile << number1 << endl;
24     outputFile << number2 << endl;
25     outputFile << number3 << endl;
26     cout << "The numbers were saved to a file.\n";
27
28     // Close the file
29     outputFile.close();
30     cout << "Done.\n";
31     return 0;
32 }
```

**Program Screen Output with Example Input Shown in Bold**

```
Enter a number: 100 Enter
Enter another number: 200 Enter
One more time. Enter a number: 300 Enter
The numbers were saved to a file.
Done.
```

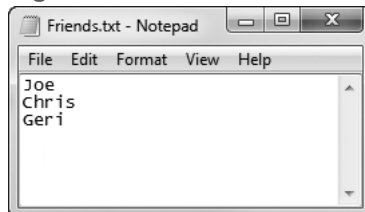
In [Program 5-17](#), lines 23 through 25 write the contents of the `number1`, `number2`, and `number3` variables to the file. Notice the `endl` manipulator is sent to the `outputFile` object immediately after each item. Sending the `endl` manipulator causes a newline to be written to the file. [Figure 5-17](#) shows the file's contents displayed in Notepad, using the example input values 100, 200, and 300. As you can see, each item appears on a separate line in the file because of the `endl` manipulators.

**Figure 5-17 Contents of Numbers.txt**



[Program 5-18](#) shows an example that reads strings as input from the keyboard then writes those strings to a file. The program asks the user to enter the first names of three friends, then it writes those names to a file named `Friends.txt`. [Figure 5-18](#) shows an example of the `Friends.txt` file opened in Notepad.

**Figure 5-18 Contents of Friends.txt**



## Program 5-18

```
1 // This program writes user input to a file.
2 #include <iostream>
3 #include <fstream>
4 #include <string>
5 using namespace std;
6
7 int main()
8 {
9     ofstream outputFile;
10    string name1, name2, name3;
11
12    // Open an output file.
13    outputFile.open("Friends.txt");
14
15    // Get the names of three friends.
16    cout << "Enter the names of three friends.\n";
17    cout << "Friend #1: ";
18    cin >> name1;
19    cout << "Friend #2: ";
20    cin >> name2;
21    cout << "Friend #3: ";
22    cin >> name3;
23
24    // Write the names to the file.
25    outputFile << name1 << endl;
26    outputFile << name2 << endl;
27    outputFile << name3 << endl;
28    cout << "The names were saved to a file.\n";
29
30    // Close the file
31    outputFile.close();
32    return 0;
33 }
```

**Program Screen Output with Example Input Shown in Bold**

Enter the names of three friends.

Friend #1: **Joe** Enter

Friend #2: **Chris** Enter

Friend #3: **Geri** Enter

The names were saved to a file.

# Reading Data from a File

The `>>` operator reads not only user input from the `cin` object, but also data from a file. Assuming `input File` is an `if stream` object, the following statement shows the `>>` operator reading data from the file into the variable name:



## Reading Data from a File

```
inputFile >> name;
```

Let's look at an example. Assume the file `Friends.txt` exists, and it contains the names shown in [Figure 5-18](#). [Program 5-19](#) opens the file, reads the names and displays them on the screen, then closes the file.

## Program 5-19

```
1 // This program reads data from a file.
2 #include <iostream>
3 #include <fstream>
4 #include <string>
5 using namespace std;
6
7 int main()
8 {
9     ifstream inputFile;
10    string name;
11
12    inputFile.open("Friends.txt");
13    cout << "Reading data from the file.\n";
14
15    inputFile >> name;    // Read name 1 from the file
16    cout << name << endl;    // Display name 1
17
18    inputFile >> name;    // Read name 2 from the file
19    cout << name << endl;    // Display name 2
20
21    inputFile >> name;    // Read name 3 from the file
22    cout << name << endl;    // Display name 3
23
24    inputFile.close();    // Close the file
25    return 0;
26 }
```

## Program Output

```
Reading data from the file.
```

```
Joe
```

```
Chris
```

```
Geri
```



# The Read Position

When a file has been opened for input, the file stream object internally maintains a special value known as a *read position*. A file's read position marks the location of the next byte that will be read from the file. When an input file is opened, its read position is initially set to the first byte in the file. So, the first read operation extracts data starting at the first byte. As data is read from the file, the read position moves forward, toward the end of the file.

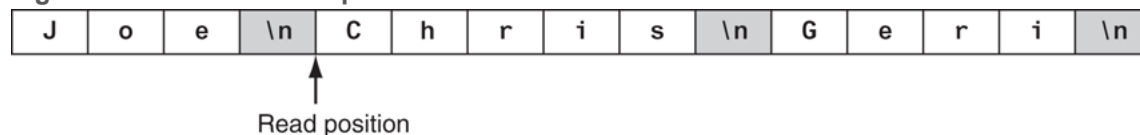
Let's see how this works with the example shown in [Program 5-19](#). When the Friends.txt file is opened by the statement in line 12, the read position for the file will be positioned as shown in [Figure 5-19](#).

**Figure 5-19 Initial read position**



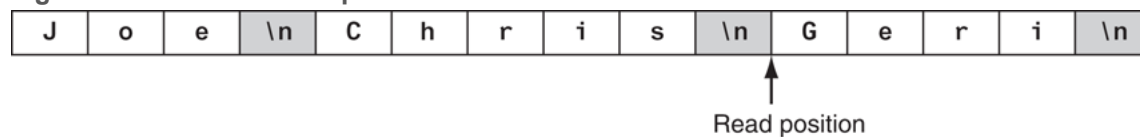
Keep in mind when the >> operator extracts data from a file, it expects to read pieces of data that are separated by whitespace characters (spaces, tabs, or newlines). When the statement in line 15 executes, the >> operator reads data from the file's current read position, up to the `\n` character. The data read from the file is assigned to the `name` object. The `\n` character is also read from the file, but is not included as part of the data. So, the `name` object will hold the value `"Joe"` after this statement executes. The file's read position will then be at the location shown in [Figure 5-20](#).

**Figure 5-20 The next read position**



When the statement in line 18 executes, it reads the next item from the file, which is `"Chris"`, and assigns that value to the `name` object. After this statement executes, the file's read position will be advanced to the next item, as shown in [Figure 5-21](#).

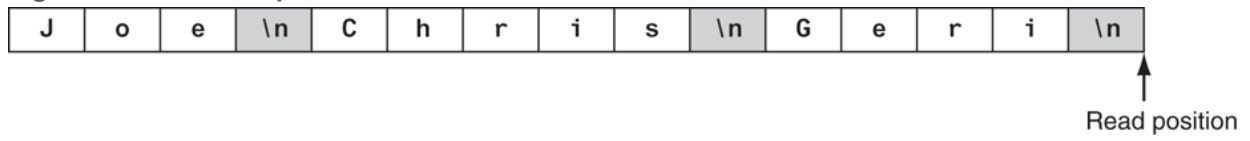
**Figure 5-21 The next read position**



When the statement in line 21 executes, it reads the next item from the file, which is `"Geri"`, and assigns that value to the `name` object. After this statement executes, the file's read position will be

advanced to the end of the file, as shown in [Figure 5-22](#).

**Figure 5-22** The read position at the end of the file

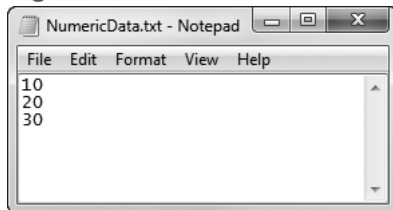


# Reading Numeric Data from a Text File

Remember when data is stored in a text file, it is encoded as text, using a scheme such as ASCII or Unicode. Even if the file contains numbers, those numbers are stored in the file as a series of characters. For example, suppose a text file contains numeric data, such as that shown in [Figure 5-17](#). The numbers that you see displayed in the figure are stored in the file as the strings "10", "20", and "30". Fortunately, you can use the `>>` operator to read data such as this from a text file into a numeric variable, and the `>>` operator will automatically convert the data to a numeric data type.

[Program 5-20](#) shows an example. It opens the file shown in [Figure 5-23](#), reads the three numbers from the file into `int` variables, and calculates their sum.

**Figure 5-23 Contents of NumericData.txt**



## Program 5-20

```
1 // This program reads numbers from a file.
2 #include <iostream>
3 #include <fstream>
4 using namespace std;
5
6 int main()
7 {
8     ifstream inFile;
9     int value1, value2, value3, sum;
10
11     // Open the file.
12     inFile.open("NumericData.txt");
13
14     // Read the three numbers from the file.
15     inFile >> value1;
16     inFile >> value2;
17     inFile >> value3;
18
19     // Close the file.
20     inFile.close();
21
22     // Calculate the sum of the numbers.
23     sum = value1 + value2 + value3;
24
25     // Display the three numbers.
26     cout << "Here are the numbers:\n"
27         << value1 << " " << value2
28         << " " << value3 << endl;
29
30     // Display the sum of the numbers.
31     cout << "Their sum is: " << sum << endl;
32     return 0;
33 }
```

## Program Output

Here are the numbers:

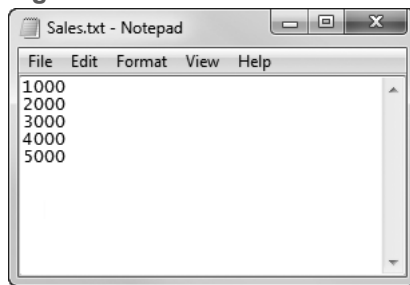
10 20 30

Their sum is: 60

# Using Loops to Process Files

Although some programs use files to store only small amounts of data, files are typically used to hold large collections of data. When a program uses a file to write or read a large amount of data, a loop is typically involved. For example, look at the code in [Program 5-21](#). This program gets sales amounts for a series of days from the user and writes those amounts to a file named Sales.txt. The user specifies the number of days of sales data he or she needs to enter. In the sample run of the program, the user enters sales amounts for 5 days. [Figure 5-24](#) shows the contents of the Sales.txt file containing the data entered by the user in the sample run.

**Figure 5-24 Contents of Sales.txt**



## Program 5-21

```
1 // This program reads data from a file.
2 #include <iostream>
3 #include <fstream>
4 using namespace std;
5
6 int main()
7 {
8     ofstream outputFile; // File stream object
9     int numberOfDays;    // Number of days of sales
10    double sales;        // Sales amount for a day
11
12    // Get the number of days.
13    cout << "For how many days do you have sales? ";
14    cin >> numberOfDays;
15
16    // Open a file named Sales.txt.
17    outputFile.open("Sales.txt");
18
19    // Get the sales for each day and write it
20    // to the file.
21    for (int count = 1; count <= numberOfDays; count++)
22    {
23        // Get the sales for a day.
24        cout << "Enter the sales for day "
25             << count << ": ";
26        cin >> sales;
27
28        // Write the sales to the file.
29        outputFile << sales << endl;
30    }
31
32    // Close the file.
33    outputFile.close();
34    cout << "Data written to Sales.txt\n";
35    return 0;
36 }
```

### Program Output (with Input Shown in Bold)

```
For how many days do you have sales? 5 Enter  
Enter the sales for day 1: 1000.00 Enter  
Enter the sales for day 2: 2000.00 Enter  
Enter the sales for day 3: 3000.00 Enter  
Enter the sales for day 4: 4000.00 Enter  
Enter the sales for day 5: 5000.00 Enter  
Data written to sales.txt.
```



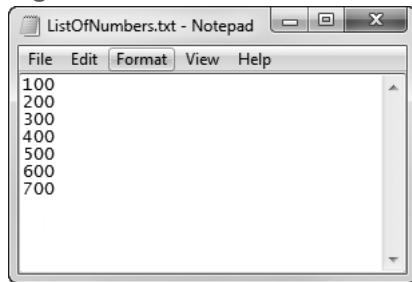
# Detecting the End of the File

Quite often a program must read the contents of a file without knowing the number of items that are stored in the file. For example, suppose you need to write a program that displays all of the items in a file, but you do not know how many items the file contains. You can open the file then use a loop to repeatedly read an item from the file and display it. However, an error will occur if the program attempts to read beyond the end of the file. The program needs some way of knowing when the end of the file has been reached so it will not try to read beyond it.

Fortunately, the `>>` operator not only reads data from a file, but also returns a true or false value indicating whether the data was successfully read or not. If the operator returns true, then a value was successfully read. If the operator returns false, it means that no value was read from the file.

Let's look at an example. A file named `ListOfNumbers.txt`, which is shown in [Figure 5-25](#), contains a list of numbers. Without knowing how many numbers the file contains, [Program 5-22](#) opens the file, reads all of the values it contains, and displays them.

**Figure 5-25 Contents of ListOfNumbers.txt**



## Program 5-22

```
1 // This program reads data from a file.
2 #include <iostream>
3 #include <fstream>
4 using namespace std;
5
6 int main()
7 {
8     ifstream inputFile;
9     int number;
10
11     // Open the file.
12     inputFile.open("ListOfNumbers.txt");
13
14     // Read the numbers from the file and
15     // display them.
16     while (inputFile >> number)
17     {
18         cout << number << endl;
19     }
20
21     // Close the file.
22     inputFile.close();
23     return 0;
24 }
```

## Program Output

```
100  
200  
300  
400  
500  
600  
700
```

Take a closer look at line 16:

```
while (inputFile >> number)
```

Notice the statement that extracts data from the file is used as the Boolean expression in the `while` loop. It works like this:

- The expression `inputFile >> number` executes.
- If an item is successfully read from the file, the item is stored in the `number` variable, and the expression returns true to indicate that it succeeded. In that case, the statement in line 18 executes and the loop repeats.
- If there are no more items to read from the file, the expression `inputFile >> number` returns false, indicating that it did not read a value. In that case, the loop terminates.


Because the value returned from the `>>` operator controls the loop, it will read items from the file until the end of the file has been reached.

# Testing for File Open Errors

Under certain circumstances, the `open` member function will not work. For example, the following code will fail if the file `info.txt` does not exist:

```
ifstream inputFile;  
inputFile.open("info.txt");
```

There is a way to determine whether the `open` member function successfully opened the file. After you call the `open` member function, you can test the file stream object as if it were a Boolean expression.

**Program 5-23**  shows an example.

## Program 5-23

```
1 // This program tests for file open errors.
2 #include <iostream>
3 #include <fstream>
4 using namespace std;
5
6 int main()
7 {
8     ifstream inputFile;
9     int number;
10
11     // Open the file.
12     inputFile.open("BadListOfNumbers.txt");
13
14     // If the file successfully opened, process it.
15     if (inputFile)
16     {
17         // Read the numbers from the file and
18         // display them.
19         while (inputFile >> number)
20         {
21             cout << number << endl;
22         }
23
24         // Close the file.
25         inputFile.close();
26     }
27     else
28     {
29         // Display an error message.
30         cout << "Error opening the file.\n";
31     }
32     return 0;
33 }
```

**Program Output (Assume BadListOfNumbers.txt does not exist)**

```
Error opening the file.
```



Let's take a closer look at certain parts of the code. Line 12 calls the `inputFile` object's `open` member function to open the file `ListOfNumbers.txt`. Then, the `if` statement in line 15 tests the value of the `inputFile` object as if it were a Boolean expression. When tested this way, the `inputFile` object will give a true value if the file was successfully opened. Otherwise, it will give a false value. The example output shows this program will display an error message if it could not open the file.

Another way to detect a failed attempt to open a file is with the `fail` member function, as shown in the following code:

```
ifstream inputFile;
inputFile.open("customers.txt");
if (inputFile.fail())
{
    cout << "Error opening file.\n";
}
else
{
    // Process the file.
}
```

The `fail` member function returns true when an attempted file operation is unsuccessful. When using file I/O, you should always test the file stream object to make sure the file was opened successfully. If the file could not be opened, the user should be informed and appropriate action taken by the program.

# Letting the User Specify a Filename

**11** In each of the previous examples, the name of the file that is opened is hard-coded as a string literal into the program. In many cases, you will want the user to specify the name of a file for the program to open. In C++ 11, you can pass a `string` object as an argument to a file stream object's `open` member function. **Program 5-24**  shows an example. This is a modified version of **Program 5-23** . This version prompts the user to enter the name of the file. In line 15, the name the user enters is stored in a `string` object named `filename`. In line 18, the `filename` object is passed as an argument to the `open` function.

## Program 5-24

```
1 // This program lets the user enter a filename.
2 #include <iostream>
3 #include <string>
4 #include <fstream>
5 using namespace std;
6
7 int main()
8 {
9     ifstream inputFile;
10    string filename;
11    int number;
12
13    // Get the filename from the user.
14    cout << "Enter the filename: ";
15    cin >> filename;
16
17    // Open the file.
18    inputFile.open(filename);
19
20    // If the file successfully opened, process it.
21    if (inputFile)
22    {
23        // Read the numbers from the file and
24        // display them.
25        while (inputFile >> number)
26        {
27            cout << number << endl;
28        }
29
30        // Close the file.
31        inputFile.close();
32    }
33    else
34    {
35        // Display an error message.
36        cout << "Error opening the file.\n";
37    }
```



```
38     return 0;  
39 }
```

### Program Output with Example Input Shown in Bold

```
Enter the filename: ListOfNumbers.txt Enter  
100  
200  
300  
400  
500  
600  
700
```

# Using the `c_str` Member Function in Older Versions of C++

In older versions of the C++ language (prior to C++ 11), a file stream object's `open` member function will not accept a `string` object as an argument. The `open` member function requires you pass the name of the file as a null-terminated string, which is also known as a *C-string*. String literals are stored in memory as null-terminated C-strings, but `string` objects are not.

Fortunately, `string` objects have a member function named `c_str` that returns the contents of the object formatted as a null-terminated C-string. Here is the general format of how you call the function:

```
stringObject.c_str()
```

In the general format, `stringObject` is the name of a `string` object. The `c_str` function returns the string that is stored in `stringObject` as a null-terminated C-string.

For example, line 18 in [Program 5-24](#) could be rewritten in the following manner to make the program compatible with an older version of C++:

```
inputFile.open(filename.c_str());
```

In this version of the statement, the value that is returned from `filename.c_str()` is passed as an argument to the `open` function.

## Checkpoint

- 5.16 What is an output file? What is an input file?
- 5.17 What three steps must be taken when a file is used by a program?
- 5.18 What is the difference between a text file and a binary file?
- 5.19 What is the difference between sequential access and random access?
- 5.20 What type of file stream object do you create if you want to write data to a file?
- 5.21 What type of file stream object do you create if you want to read data from a file?
- 5.22 Write a short program that uses a `for` loop to write the numbers 1 through 10 to a file.
- 5.23 Write a short program that opens the file created by the program you wrote for Checkpoint 5.22, reads all of the numbers from the file, and displays them.

## 5.12 Optional Topics: Breaking and Continuing a Loop

### Concept:

The `break` statement causes a loop to terminate early. The `continue` statement causes a loop to stop its current iteration and begin the next one.



### Warning!

Use the `break` and `continue` statements with great caution. Because they bypass the normal condition that controls the loop's iterations, these statements make code difficult to understand and debug. For this reason, you should avoid using `break` and `continue` whenever possible. However, because they are part of the C++ language, we discuss them briefly in this section.

Sometimes it's necessary to stop a loop before it goes through all its iterations. The `break` statement, which was used with `switch` in [Chapter 4](#), can also be placed inside a loop. When it is encountered, the loop stops, and the program jumps to the statement immediately following the loop.

The `while` loop in the following program segment appears to execute 10 times, but the `break` statement causes it to stop after the fifth iteration.

```
int count = 0;
while (count++ < 10)
{
    cout << count << endl;
    if (count == 5)
        break;
}
```

[Program 5-25](#) uses the `break` statement to interrupt a `for` loop. The program asks the user for a number, then displays the value of that number raised to the powers of 0 through 10. The user can stop the loop at any time by entering Q.

## Program 5-25

```
1 // This program raises the user's number to
the powers
2 // of 0 through 10.
3 #include <iostream>
4 #include <cmath>
5 using namespace std;
6
7 int main()
8 {
9     double value;
10    char choice;
11
12    cout << "Enter a number: ";
13    cin >> value;
14    cout << "This program will raise " <<
value;
15    cout << " to the powers of 0 through
10.\n";
16    for (int count = 0; count <= 10; count++)
17    {
18        cout << value << " raised to the power
of ";
19        cout << count << " is " << pow(value,
```

```
count);  
20         cout << "\nEnter Q to quit or any  
other key ";  
21         cout << "to continue. ";  
22         cin >> choice;  
23         if (choice == 'Q' || choice == 'q')  
24             break;  
25     }  
26     return 0;  
27 }
```

**Program Output with Example Input Shown in Bold**

Enter a number: **2** Enter

This program will raise 2 to the powers of 0 through 10.

2 raised to the power of 0 is 1

Enter Q to quit or any other key to continue. **C** Enter

2 raised to the power of 1 is 2

Enter Q to quit or any other key to continue. **C** Enter

2 raised to the power of 2 is 4

Enter Q to quit or any other key to continue. **Q** Enter

# Using break in a Nested Loop

In a nested loop, the `break` statement only interrupts the loop in which it is placed. The following program segment displays five rows of asterisks on the screen. The outer loop controls the number of rows, and the inner loop controls the number of asterisks in each row. The inner loop is designed to display 20 asterisks, but the `break` statement stops it during the eleventh iteration.

```
for (int row = 0; row < 5; row++)
{
    for (int star = 0; star < 20; star++)
    {
        cout << '*';
        if (star == 10)
            break;
    }
    cout << endl;
}
```

The output of the program segment above is:



\* \* \* \* \*

\* \* \* \* \*

\* \* \* \* \*

\* \* \* \* \*

\* \* \* \* \*

# The `continue` Statement

The `continue` statement causes the current iteration of a loop to end immediately. When `continue` is encountered, all the statements in the body of the loop that appear after it are ignored, and the loop prepares for the next iteration.


In a `while` loop, this means the program jumps to the test expression at the top of the loop. As usual, if the expression is still true, the next iteration begins. In a `do-while` loop, the program jumps to the test expression at the bottom of the loop, which determines whether the next iteration will begin. In a `for` loop, `continue` causes the update expression to be executed, then the test expression to be evaluated.

The following program segment demonstrates the use of `continue` in a `while` loop:

```
int testVal = 0;
while (testVal++ < 10)
{
    if (testVal == 4)
        continue;
    cout << testVal << " ";
}
```

This loop looks like it displays the integers 1 through 10. When `testVal` is equal to 4, however, the `continue` statement causes the loop to skip the `cout` statement and begin the next iteration. The output of the loop is

```
1 2 3 5 6 7 8 9 10
```

**Program 5-26**  demonstrates the `continue` statement. The program calculates the charges for DVD rentals, where current releases cost \$3.50 and all others cost \$2.50. If a customer rents several DVDs, every third one is free. The `continue` statement is used to skip the part of the loop that calculates the charges for every third DVD.

## Program 5-26

```
1 // This program calculates the charges for DVD
rentals.
2 // Every third DVD is free.
3 #include <iostream>
4 #include <iomanip>
5 using namespace std;
6
7 int main()
8 {
9     int dvdCount = 1;    // DVD counter
10    int numDVDs;         // Number of DVDs
rented
11    double total = 0.0; // Accumulator
12    char current;       // Current release, Y
or N
13
14    // Get the number of DVDs.
15    cout << "How many DVDs are being rented?
";
16    cin >> numDVDs;
17
18    // Determine the charges.
19    do
```

```

20     {
21         if ((dvdCount % 3) == 0)
22         {
23             cout << "DVD #" << dvdCount << "
is free!\n";
24             continue; // Immediately start the
next iteration
25         }
26         cout << "Is DVD #" << dvdCount;
27         cout << " a current release? (Y/N) ";
28         cin >> current;
29         if (current == 'Y' || current == 'y')
30             total += 3.50;
31         else
32             total += 2.50;
33     } while (dvdCount++ < numDVDs);
34
35     // Display the total.
36     cout << fixed << showpoint <<
setprecision(2);
37     cout << "The total is $" << total <<
endl;
38     return 0;
39 }

```

**Program Output with Example Input Shown in Bold**

```
How many DVDs are being rented? 6 Enter
Is DVD #1 a current release? (Y/N) y Enter
Is DVD #2 a current release? (Y/N) n Enter
DVD #3 is free!
Is DVD #4 a current release? (Y/N) n Enter
Is DVD #5 a current release? (Y/N) y Enter
DVD #6 is free!
The total is $12.00
```

Case Study: See the Loan Amortization Case Study on the Computer Science Portal at [www.pearsonhighered.com/gaddis](http://www.pearsonhighered.com/gaddis).

# Review Questions and Exercises

## Short Answer

1. Why should you indent the statements in the body of a loop?
2. Describe the difference between pretest loops and posttest loops.
3. Why are the statements in the body of a loop called conditionally executed statements?
4. What is the difference between the `while` loop and the `do-while` loop?
5. Which loop should you use in situations where you wish the loop to repeat until the test expression is false, and the loop should not execute if the test expression is false to begin with?
6. Which loop should you use in situations where you wish the loop to repeat until the test expression is false, but the loop should execute at least one time?
7. Which loop should you use when you know the number of required iterations?
8. Why is it critical that counter variables be properly initialized?
9. Why is it critical that accumulator variables be properly initialized?

10. Why should you be careful not to place a statement in the body of a `for` loop that changes the value of the loop's counter variable?
11. What header file do you need to include in a program that performs file operations?
12. What data type do you use when you want to create a file stream object that can write data to a file?
13. What data type do you use when you want to create a file stream object that can read data from a file?
14. Why should a program close a file when it's finished using it?
15. What is a file's read position? Where is the read position when a file is first opened for reading?



# Fill-in-the-Blank

16. To \_\_\_\_\_ a value means to increase it by one, and to \_\_\_\_\_ a value means to decrease it by one.
17. When the increment or decrement operator is placed before the operand (or to the operand's left), the operator is being used in \_\_\_\_\_ mode.
18. When the increment or decrement operator is placed after the operand (or to the operand's right), the operator is being used in \_\_\_\_\_ mode.
19. The statement or block that is repeated is known as the \_\_\_\_\_ of the loop.
20. Each repetition of a loop is known as a(n) \_\_\_\_\_.
21. A loop that evaluates its test expression before each repetition is a(n) \_\_\_\_\_ loop.
22. A loop that evaluates its test expression after each repetition is a(n) \_\_\_\_\_ loop.
23. A loop that does not have a way of stopping is a(n) \_\_\_\_\_ loop.
24. A(n) \_\_\_\_\_ is a variable that "counts" the number of times a loop repeats.
25. A(n) \_\_\_\_\_ is a sum of numbers that accumulates with each iteration of a loop.
26. A(n) \_\_\_\_\_ is a variable that is initialized to some starting value, usually zero, then has numbers added to it in each iteration of a loop.

27. A(n) \_\_\_\_\_ is a special value that marks the end of a series of values.
28. The \_\_\_\_\_ loop always iterates at least once.
29. The \_\_\_\_\_ and \_\_\_\_\_ loops will not iterate at all if their test expressions are false to start with.
30. The \_\_\_\_\_ loop is ideal for situations that require a counter.
31. Inside the `for` loop's parentheses, the first expression is the \_\_\_\_\_, the second expression is the \_\_\_\_\_, and the third expression is the \_\_\_\_\_.
32. A loop that is inside another is called a(n) \_\_\_\_\_ loop.
33. The \_\_\_\_\_ statement causes a loop to terminate immediately.
34. The \_\_\_\_\_ statement causes a loop to skip the remaining statements in the current iteration.

# Algorithm Workbench

35. Write a `while` loop that lets the user enter a number. The number should be multiplied by 10, and the result stored in the variable `product`. The loop should iterate as long as `product` contains a value less than 100.
36. Write a `do-while` loop that asks the user to enter two numbers. The numbers should be added and the sum displayed. The user should be asked if he or she wishes to perform the operation again. If so, the loop should repeat; otherwise, it should terminate.
37. Write a `for` loop that displays the following set of numbers:  

```
0, 10, 20, 30, 40, 50 . . . 1000
```
38. Write a loop that asks the user to enter a number. The loop should iterate 10 times and keep a running total of the numbers entered.
39. Write a nested loop that displays 10 rows of '#' characters. There should be 15 '#' characters in each row.
40. Convert the following `while` loop to a `do-while` loop:

```
int x = 1;
while (x > 0)
{
    cout << "enter a number: ";
    cin >> x;
}
```

41. Convert the following `do-while` loop to a `while` loop:

```
char sure;
do
{
    cout << "Are you sure you want to quit? ";
    cin >> sure;
} while (sure != 'Y' && sure != 'N');
```

42. Convert the following `while` loop to a `for` loop:

```
int count = 0;
while (count < 50)
{
    cout << "count is " << count << endl;
    count++;
}
```

43. Convert the following `for` loop to a `while` loop:

```
for (int x = 50; x > 0; x--)  
{  
    cout << x << " seconds to go.\n";  
}
```

44. Write code that does the following: Opens an output file with the filename Numbers.txt, uses a loop to write the numbers 1 through 100 to the file, then closes the file.
45. Write code that does the following: Opens the Numbers.txt file that was created by the code you wrote in Question 44, reads all of the numbers from the file and displays them, then closes the file.
46. Modify the code that you wrote in Question 45 so it adds all of the numbers read from the file and displays their total.

# True or False

47. T F The operand of the increment and decrement operators can be any valid mathematical expression.

48. T F The `cout` statement in the following program segment will display 5:

```
int x = 5;  
cout << x++;
```

49. T F The `cout` statement in the following program segment will display 5:

```
int x = 5;  
cout << ++x;
```

50. T F The `while` loop is a pretest loop.

51. T F The `do-while` loop is a pretest loop.

52. T F The `for` loop is a posttest loop.

53. T F It is not necessary to initialize counter variables.

54. T F All three of the `for` loop's expressions may be omitted.

55. T F One limitation of the `for` loop is that only one variable may be initialized in the initialization expression.

56. T F Variables may be defined inside the body of a loop.

57. T F A variable may be defined in the initialization expression of the `for` loop.
58. T F In a nested loop, the outer loop executes faster than the inner loop.
59. T F In a nested loop, the inner loop goes through all of its iterations for every single iteration of the outer loop.
60. T F To calculate the total number of iterations of a nested loop, add the number of iterations of all the loops.
61. T F The `break` statement causes a loop to stop the current iteration and begin the next one.
62. T F The `continue` statement causes a terminated loop to resume.
63. T F In a nested loop, the `break` statement only interrupts the loop in which it is placed.
64. T F When you call an `ofstream` object's `open` member function, the specified file will be erased if it already exists.

# Find the Errors

Each of the following programs has errors. Find as many as you can.

65. 

```
// Find the error in this program.
#include <iostream>
using namespace std;
int main()
{
    int num1 = 0, num2 = 10, result;
    num1++;
    result = ++(num1 + num2);
    cout << num1 << " " << num2 << " " << result;
    return 0;
}
```



66.

```
// This program adds two numbers entered by the user.
#include <iostream>
using namespace std;
int main()
{
    int num1, num2;
    char again;
    while (again == 'y' || again == 'Y')
        cout << "Enter a number: ";
        cin >> num1;
        cout << "Enter another number: ";
        cin >> num2;
        cout << "Their sum is << (num1 + num2) << endl;
        cout << "Do you want to do this again? ";
        cin >> again;
    return 0;
}
```

67.

```
// This program uses a loop to raise a number to a power.
#include <iostream>
using namespace std;
int main()
{
    int num, bigNum, power, count;
    cout << "Enter an integer: ";
    cin >> num;
    cout << "What power do you want it raised to? ";
    cin >> power;
    bigNum = num;
    while (count++ < power);
        bigNum *= num;
    cout << "The result is << bigNum << endl;
    return 0;
}
```

68.

```
// This program averages a set of numbers.
#include <iostream>
using namespace std;
int main()
{
    int numCount, total;
    double average;
    cout << "How many numbers do you want to average? ";
    cin >> numCount;
    for (int count = 0; count < numCount; count++)
    {
        int num;
        cout << "Enter a number: ";
        cin >> num;
        total += num;
        count++;
    }
    average = total / numCount;
    cout << "The average is << average << endl;
    return 0;
}
```

69.

```
// This program displays the sum of two numbers.
#include <iostream>
using namespace std;
int main()
{
    int choice, num1, num2;
    do
    {
        cout << "Enter a number: ";
        cin >> num1;
        cout << "Enter another number: ";
        cin >> num2;
        cout << "Their sum is " << (num1 + num2) << endl;
        cout << "Do you want to do this again?\n";
        cout << "1 = yes, 0 = no\n";
        cin >> choice;
    } while (choice = 1)
    return 0;
}
```

70.

```
// This program displays the sum of the numbers 1-100.  
#include <iostream>  
using namespace std;  
int main()  
{  
    int count = 1, total;  
    while (count <= 100)  
        total += count;  
    cout << "The sum of the numbers 1-100 is ";  
    cout << total << endl;  
    return 0;  
}
```

# Programming Challenges

## 1. **Sum of Numbers**

Write a program that asks the user for a positive integer value. The program should use a loop to get the sum of all the integers from 1 up to the number entered. For example, if the user enters 50, the loop will find the sum of 1, 2, 3, 4, . . . , 50.

*Input Validation: Do not accept a negative starting number.*

## 2. **Characters for the ASCII Codes**

Write a program that uses a loop to display the characters for the ASCII codes 0 through 127. Display 16 characters on each line.

## 3. **Ocean Levels**

Assuming the ocean's level is currently rising at about 1.5 millimeters per year, write a program that displays a table showing the number of millimeters that the ocean will have risen each year for the next 25 years.

## 4. **Calories Burned**

Running on a particular treadmill you burn 3.6 calories per minute. Write a program that uses a loop to display the number of calories burned after 5, 10, 15, 20, 25, and 30 minutes.



## Solving the Calories Burned Problem

### 5. Membership Fees Increase

A country club, which currently charges \$2,500 per year for membership, has announced it will increase its membership fee by 4 percent each year for the next 6 years. Write a program that uses a loop to display the projected rates for the next 6 years.

### 6. Distance Traveled

The distance a vehicle travels can be calculated as follows:

```
distance = speed * time
```

For example, if a train travels 40 miles per hour for 3 hours, the distance traveled is 120 miles.

Write a program that asks the user for the speed of a vehicle (in miles per hour) and how many hours it has traveled. The program should then use a loop to display the distance the vehicle has traveled for each hour of that time period. Here is an example of the output:

```
What is the speed of the vehicle in mph? 40
```

```
How many hours has it traveled? 3
```

```
Hour Distance Traveled
```

```
-----
```

```
1 40
```

```
2 80
```

```
3 120
```

Input Validation: Do not accept a negative number for speed and do not accept any value less than 1 for time traveled.

## 7. Pennies for Pay

Write a program that calculates how much a person would earn over a period of time if his or her salary is one penny the first day and two pennies the second day, and continues to double each day. The program should ask the user for the number of days. Display a table showing how much the salary was for each day, and then show the total pay at the end of the period. The output should be displayed in a dollar amount, not the number of pennies.

*Input Validation: Do not accept a number less than 1 for the number of days worked.*

## 8. Math Tutor

*This program started in Programming Challenge 17, of [Chapter 3](#), and was modified in Programming Challenge 11 of [Chapter 4](#). Modify the program again so it displays a menu allowing the user to select an addition, subtraction, multiplication, or division problem. The final selection on the*



menu should let the user quit the program. After the user has finished the math problem, the program should display the menu again. This process is repeated until the user chooses to quit the program.

Input Validation: If the user selects an item not on the menu, display an error message and display the menu again.

## 9. Hotel Occupancy

Write a program that calculates the occupancy rate for a hotel. The program should start by asking the user how many floors the hotel has. A loop should then iterate once for each floor. In each iteration, the loop should ask the user for the number of rooms on the floor and how many of them are occupied. After all the iterations, the program should display how many rooms the hotel has, how many of them are occupied, how many are unoccupied, and the percentage of rooms that are occupied. The percentage may be calculated by dividing the number of rooms occupied by the number of rooms.



### **Note:**

It is traditional that most hotels do not have a thirteenth floor. The loop in this program should skip the entire thirteenth iteration.

Input Validation: Do not accept a value less than 1 for the number of floors. Do not accept a number less than 10 for the

number of rooms on a floor.

#### 10. **Average Rainfall**

Write a program that uses nested loops to collect data and calculate the average rainfall over a period of years. The program should first ask for the number of years. The outer loop will iterate once for each year. The inner loop will iterate 12 times, once for each month. Each iteration of the inner loop will ask the user for the inches of rainfall for that month. After all iterations, the program should display the number of months, the total inches of rainfall, and the average rainfall per month for the entire period.

Input Validation: Do not accept a number less than 1 for the number of years. Do not accept negative numbers for the monthly rainfall.

#### 11. **Population**

Write a program that will predict the size of a population of organisms. The program should ask the user for the starting number of organisms, their average daily population increase (as a percentage), and the number of days they will multiply. A loop should display the size of the population for each day.

Input Validation: Do not accept a number less than 2 for the starting size of the population. Do not accept a negative number for average daily population increase. Do not accept a number less than 1 for the number of days they will multiply.

#### 12. **Celsius to Fahrenheit Table**

In Programming Challenge 12 of [Chapter 3](#), you were asked to write a program that converts a Celsius temperature to Fahrenheit. Modify that program so that it uses a loop to

display a table of the Celsius temperatures 0–20, and the Fahrenheit equivalents.

### 13. **The Greatest and Least of These**

Write a program with a loop that lets the user enter a series of integers. The user should enter –99 to signal the end of the series. After all the numbers have been entered, the program should display the largest and smallest numbers entered.

### 14. **Student Line Up**

A teacher has asked all her students to line up according to their first name. For example, in one class Amy will be at the front of the line, and Yolanda will be at the end. Write a program that prompts the user to enter the number of students in the class, then loops to read that many names. Once all the names have been read, it reports which student would be at the front of the line and which one would be at the end of the line. You may assume that no two students have the same name.

Input Validation: Do not accept a number less than 1 or greater than 25 for the number of students.

### 15. **Payroll Report**

Write a program that displays a weekly payroll report. A loop in the program should ask the user for the employee number, gross pay, state tax, federal tax, and FICA withholdings. The loop will terminate when 0 is entered for the employee number. After the data is entered, the program should display totals for gross pay, state tax, federal tax, FICA withholdings, and net pay.

Input Validation: Do not accept negative numbers for any of the items entered. Do not accept values for state, federal, or FICA withholdings that are greater than the gross pay. If the sum of state tax + federal tax + FICA withholdings for any employee is greater than gross pay, print an error message and ask the user to reenter the data for that employee.

#### 16. **Savings Account Balance**

Write a program that calculates the balance of a savings account at the end of a period of time. It should ask the user for the annual interest rate, the starting balance, and the number of months that have passed since the account was established. A loop should then iterate once for every month, performing the following:

- A. Ask the user for the amount deposited into the account during the month. (Do not accept negative numbers.) This amount should be added to the balance.
- B. Ask the user for the amount withdrawn from the account during the month. (Do not accept negative numbers.) This amount should be subtracted from the balance.
- C. Calculate the monthly interest. The monthly interest rate is the annual interest rate divided by 12. Multiply the monthly interest rate by the balance, and add the result to the balance.

After the last iteration, the program should display the ending balance, the total amount of deposits, the total amount of withdrawals, and the total interest earned.



### **Note:**

If a negative balance is calculated at any point, a message should be displayed indicating the account has been closed and the loop should terminate.

## **17. Sales Bar Chart**

Write a program that asks the user to enter today's sales for five stores. The program should then display a bar graph comparing each store's sales. Create each bar in the bar graph by displaying a row of asterisks. Each asterisk should represent \$100 of sales.

Here is an example of the program's output:

```
Enter today's sales for store 1: 1000 Enter
Enter today's sales for store 2: 1200 Enter
Enter today's sales for store 3: 1800 Enter
Enter today's sales for store 4: 800 Enter
Enter today's sales for store 5: 1900 Enter

SALES BAR CHART

(Each * = $100)

Store 1: *****
Store 2: *****
Store 3: *****
Store 4: *****
Store 5: *****
```

## 18. Population Bar Chart

Write a program that produces a bar chart showing the population growth of Prairieville, a small town in the Midwest, at 20-year intervals during the past 100 years. The program should read in the population figures (rounded to the nearest 1,000 people) for 1900, 1920, 1940, 1960, 1980, and 2000 from a file. For each year, it should display the date and a bar consisting of one asterisk for each 1,000 people. The data can be found in the `People.txt` file.

Here is an example of how the chart might begin:

```
PRAIRIEVILLE POPULATION GROWTH
```

```
(each * represents 1,000 people)
```

```
1900 **
```

```
1920 ****
```

```
1940 *****
```

### 19. Budget Analysis

Write a program that asks the user to enter the amount that he or she has budgeted for a month. A loop should then prompt the user to enter each of his or her expenses for the month and keep a running total. When the loop finishes, the program should display the amount that the user is over or under budget.

### 20. Random Number Guessing Game

Write a program that generates a random number and asks the user to guess what the number is. If the user's guess is higher than the random number, the program should display "Too high, try again." If the user's guess is lower than the random number, the program should display "Too low, try again." The program should use a loop that repeats until the user correctly guesses the random number.

### 21. Random Number Guessing Game Enhancement

Enhance the program that you wrote for Programming Challenge 20 so it keeps a count of the number of guesses the user makes. When the user correctly guesses the random number, the program should display the number of guesses.

### 22. Square Display

Write a program that asks the user for a positive integer no greater than 15. The program should then display a square on the screen using the character 'X'. The number entered by the user will be the length of each side of the square. For example, if the user enters 5, the program should display the following:

```
XXXXXX  
XXXXXX  
XXXXXX  
XXXXXX  
XXXXXX
```

If the user enters 8, the program should display the following:

```
XXXXXXXXXX  
XXXXXXXXXX  
XXXXXXXXXX  
XXXXXXXXXX  
XXXXXXXXXX  
XXXXXXXXXX  
XXXXXXXXXX  
XXXXXXXXXX
```

### 23. Pattern Displays

Write a program that uses a loop to display Pattern A below, followed by another loop that displays Pattern B.

### 24. Using Files—Numeric Processing



If you have downloaded this book's source code from the Computer Science Portal, you will find a file named Random.txt in the **Chapter 05** folder. (The Portal can be found at [www.pearsonhighered.com/gaddis](http://www.pearsonhighered.com/gaddis).) This file contains a long list of random numbers. Copy the file to your system, then write a program that opens the file, reads all the numbers from the file, and calculates the following:

- A. The number of numbers in the file
- B. The sum of all the numbers in the file (a running total)
- C. The average of all the numbers in the file

The program should display the number of numbers found in the file, the sum of the numbers, and the average of the numbers.

#### 25. **Using Files—Student Line Up**

Modify the Student Line Up program described in Programming Challenge 14 so it gets the names from a file. Names should be read in until there is no more data to read. If you have downloaded this book's source code you will find a file named LineUp.txt in the **Chapter 05** folder. You can use this file to test the program.

#### 26. **Personal Web Page Generator**

Write a program that asks the user for his or her name, then asks the user to enter a sentence that describes himself or herself. Here is an example of the program's screen:

```
Enter your name: Julie Taylor Enter
```


```
Describe yourself: I am a computer science major, a  
member of the Jazz club, and I hope to work as a mobile  
app developer after I graduate.
```

Once the user has entered the requested input, the program should create an HTML file, containing the input, for a simple webpage. Here is an example of the HTML content, using the sample input previously shown:

```
<html>  
<head>  
</head>  
<body>  
  <center>  
    <h1>Julie Taylor</h1>  
  </center>  
  <hr />  
  I am a computer science major, a member of the Jazz  
club,  
  and I hope to work as a mobile app developer after I  
graduate.  
  <hr />  
</body>  
</html>
```

## 27. Average Steps Taken

A Personal Fitness Tracker is a wearable device that tracks your physical activity, calories burned, heart rate, sleeping patterns, and so on. One common physical activity that most of these devices track is the number of steps you take each day.

If you have downloaded this book's source code, you will find a file named `steps.txt` in the **Chapter 05**  folder. The `steps.txt` file contains the number of steps a person has taken each day for a year. There are 365 lines in the file, and each line contains the number of steps taken during a day. (The first line is the number of steps taken on January 1, the second line is the number of steps taken on January 2, and so forth.) Write a program that reads the file, then displays the average number of steps taken for each month. (The data is from a year that was not a leap year, so February has 28 days.)

---

# Chapter 6 Functions

---

## Topics

[6.1 Focus on Software Engineering: Modular Programming](#) 

[6.2 Defining and Calling Functions](#) 

[6.3 Function Prototypes](#) 

[6.4 Sending Data into a Function](#) 

[6.5 Passing Data by Value](#) 

[6.6 Focus on Software Engineering: Using Functions in a Menu-Driven Program](#) 

[6.7 The `return` Statement](#) 

[6.8 Returning a Value from a Function](#) 

[6.9 Returning a Boolean Value](#) 


[6.10 Local and Global Variables](#) 

[6.11 Static Local Variables](#) 

**6.12 Default Arguments** 

**6.13 Using Reference Variables as Parameters** 

**6.14 Overloading Functions** 

**6.15 The `exit()` Function** 


**6.16 Stubs and Drivers** 

## 6.1 Focus on Software Engineering: Modular Programming

### Concept:

A program may be broken up into manageable functions.

A function is a collection of statements that performs a specific task. So far, you have experienced functions in two ways: (1) you have created a function named `main` in every program you've written, and (2) you have used library functions such as `pow` and `strcmp`. In this chapter, you will learn how to create your own functions that can be used like library functions.

Functions are commonly used to break a problem down into small, manageable pieces. Instead of writing one long function that contains all of the statements necessary to solve a problem, several small functions that each solve a specific part of the problem can be written. These small functions can then be executed in the desired order to solve the problem. This approach is sometimes called *divide and conquer* because a large problem is divided into several smaller problems that are easily solved. **Figure 6-1**  illustrates this idea by comparing two programs: one that uses a long, complex function containing all of the statements necessary to solve a problem, and another that divides a problem into smaller problems, each of which is handled by a separate function.



## 6.2 Defining and Calling Functions

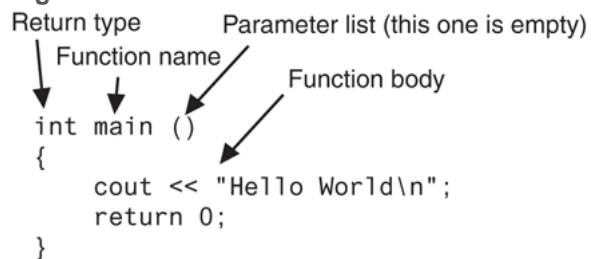
### Concept:

A function call is a statement that causes a function to execute. A function definition contains the statements that make up the function.

When creating a function, you must write its *definition*. All function definitions have the following parts:

**Figure 6-2** shows the definition of a simple function with the various parts labeled.

**Figure 6-2 Function definition**



The diagram shows a C++ function definition with four labels and arrows pointing to specific parts of the code:

- Return type**: points to the `int` keyword.
- Function name**: points to the `main` identifier.
- Parameter list (this one is empty)**: points to the empty parentheses `()`.
- Function body**: points to the block of code between the curly braces, including `cout << "Hello World\n";` and `return 0;`.

```
int main ()  
{  
    cout << "Hello World\n";  
    return 0;  
}
```

The line in the definition that reads `int main()` is called the *function header*.



## void Functions

You already know that a function can return a value. The `main` function in all of the programs you have seen in this book is declared to return an `int` value to the operating system. The `return 0;` statement causes the value 0 to be returned when the `main` function finishes executing.

It isn't necessary for all functions to return a value, however. Some functions simply perform one or more statements, and then terminate. These are called *void functions*. The `displayMessage` function, which follows, is an example.

```
void displayMessage()
{
    cout << "Hello from the function displayMessage.\n";
}
```

The function's name is `displayMessage`. This name gives an indication of what the function does: It displays a message. You should always give functions names that reflect their purpose. Notice the function's return type is `void`. This means the function does not return a value to the part of the program that executed it. Also notice the function has no `return` statement. It simply displays a message on the screen and exits.

# Calling a Function

A function is executed when it is *called*. Function `main` is called automatically when a program starts, but all other functions must be executed by *function call* statements. When a function is called, the program branches to that function and executes the statements in its body. Let's look at [Program 6-1](#), which contains two functions: `main` and `displayMessage`.

## Program 6-1

```
1 // This program has two functions: main and displayMessage
2 #include <iostream>
3 using namespace std;
4
5 //*****
6 // Definition of function displayMessage *
7 // This function displays a greeting. *
8 //*****
9
10 void displayMessage()
11 {
12     cout << "Hello from the function displayMessage.\n";
13 }
14
15 //*****
16 // Function main *
17 //*****
18
19 int main()
20 {
21     cout << "Hello from main.\n";
22     displayMessage();
23     cout << "Back in function main again.\n";
24     return 0;
25 }
```

## Program Output

```
Hello from main.
Hello from the function displayMessage.
Back in function main again.
```

The function `displayMessage` is called by the following statement in line 22:

```
displayMessage();
```

This statement is the function call. It is simply the name of the function followed by a set of parentheses and a semicolon. Let's compare this with the function header:

Function Header → `void displayMessage()`

Function Call → `displayMessage();`

The function header is part of the function definition. It declares the function's return type, name, and parameter list. It is not terminated with a semicolon because the definition of the function's body follows it.

The function call is a statement that executes the function, so it is terminated with a semicolon like all other C++ statements. The return type is not listed in the function call, and, if the program is not passing data into the function, the parentheses are left empty.



### **Note:**

Later in this chapter, you will see how data can be passed into a function by being listed inside the parentheses.

Even though the program starts executing at `main`, the function `displayMessage` is defined first. This is because the compiler must know the function's return type, the number of parameters, and the type of each parameter before the function is called. One way to ensure the compiler will know this information is to place the function definition before all calls to that function. (Later, you will see an alternative, preferred method of accomplishing this.)

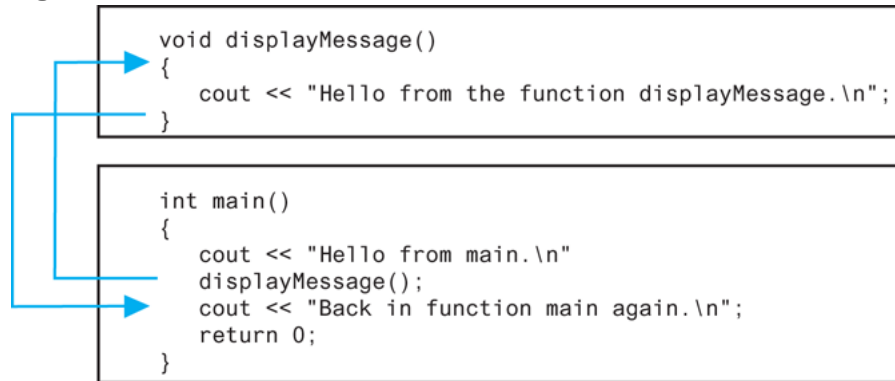


### **Note:**

You should always document your functions by writing comments that describe what they do. These comments should appear just before the function definition.

Notice how [Program 6-1](#) flows. It starts, of course, in function `main`. When the call to `displayMessage` is encountered, the program branches to that function and performs its statements. Once `displayMessage` has finished executing, the program branches back to function `main` and resumes with the line that follows the function call. This is illustrated in [Figure 6-3](#).

**Figure 6-3** A function call



Function call statements may be used in control structures like loops, `if` statements, and `switch` statements. [Program 6-2](#) places the `displayMessage` function call inside a loop.

## Program 6-2

```
1 // The function displayMessage is repeatedly called from a loop.
2 #include <iostream>
3 using namespace std;
4
5 //*****
6 // Definition of function displayMessage *
7 // This function displays a greeting. *
8 //*****
9
10 void displayMessage()
11 {
12     cout << "Hello from the function displayMessage.\n";
13 }
14
15 //*****
16 // Function main *
17 //*****
18
19 int main()
20 {
21     cout << "Hello from main.\n";
22     for (int count = 0; count < 5; count++)
23         displayMessage(); // Call displayMessage
24     cout << "Back in function main again.\n";
25     return 0;
26 }
```

## Program Output

```
Hello from main.  
Hello from the function displayMessage.  
Hello from the function displayMessage.  
Hello from the function displayMessage.  
Hello from the function displayMessage.  
Hello from the function displayMessage.  
Back in function main again.
```

It is possible to have many functions and function calls in a program. [Program 6-3](#) has three functions: `main`, `first`, and `second`.

## Program 6-3

```
1 // This program has three functions: main, first, and second.
2 #include <iostream>
3 using namespace std;
4
5 //*****
6 // Definition of function first *
7 // This function displays a message. *
8 //*****
9
10 void first()
11 {
12     cout << "I am now inside the function first.\n";
13 }
14
15 //*****
16 // Definition of function second *
17 // This function displays a message. *
18 //*****
19
20 void second()
21 {
22     cout << "I am now inside the function second.\n";
23 }
24
25 //*****
26 // Function main *
27 //*****
28
29 int main()
30 {
31     cout << "I am starting in function main.\n";
32     first(); // Call function first
33     second(); // Call function second
34     cout << "Back in function main again. \n";
35     return 0;
36 }
```



## Program Output

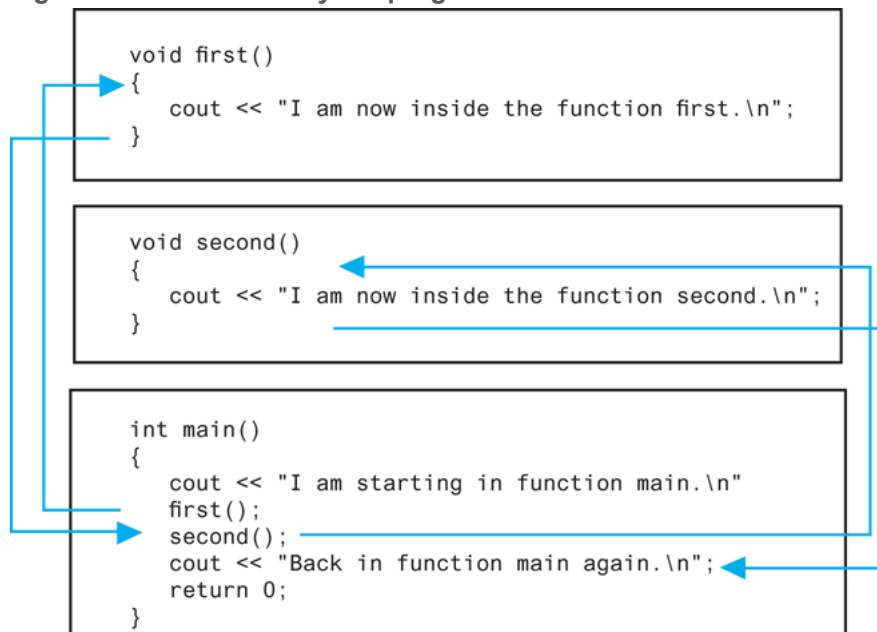
```
I am starting in function main.  
I am now inside the function first.  
I am now inside the function second.  
Back in function main again.
```

In lines 32 and 33 of [Program 6-3](#), function `main` contains a call to `first` and a call to `second`:

```
first();  
second();
```

Each call statement causes the program to branch to a function then back to `main` when the function is finished. [Figure 6-4](#) illustrates the paths taken by the program.

**Figure 6-4** Paths taken by the program



Functions may also be called in a hierarchical, or layered, fashion. This is demonstrated by [Program 6-4](#), which has three functions: `main`, `deep`, and `deeper`.

## Program 6-4

```
1 // This program has three functions: main, deep, and deeper
2 #include <iostream>
3 using namespace std;
4
5 //*****
6 // Definition of function deeper *
7 // This function displays a message. *
8 //*****
9
10 void deeper()
11 {
12     cout << "I am now inside the function deeper.\n";
13 }
14
15 //*****
16 // Definition of function deep *
17 // This function displays a message. *
18 //*****
19
20 void deep()
21 {
22     cout << "I am now inside the function deep.\n";
23     deeper(); // Call function deeper
24     cout << "Now I am back in deep.\n";
25 }
26
27 //*****
28 // Function main *
29 //*****
30
31 int main()
32 {
33     cout << "I am starting in function main.\n";
34     deep(); // Call function deep
35     cout << "Back in function main again.\n";
```

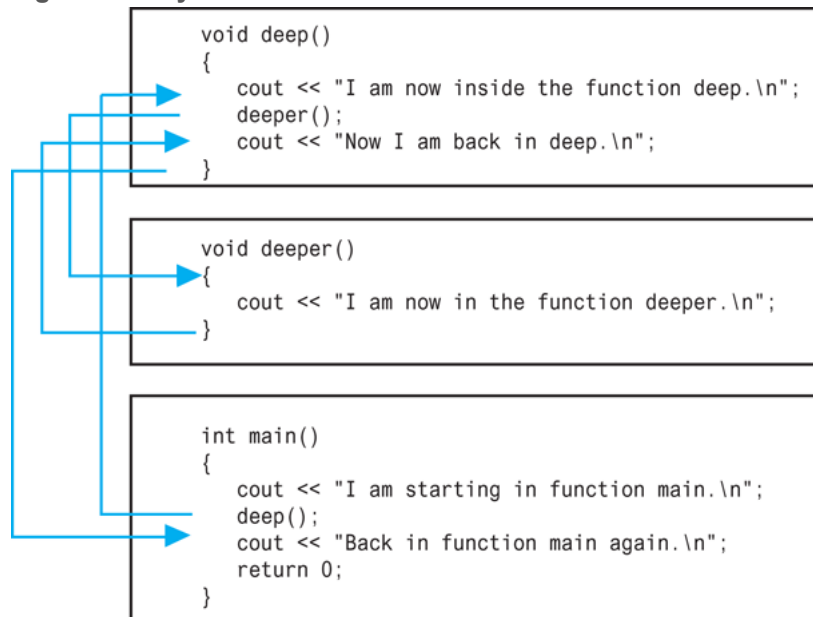
```
36     return 0;
37 }
```

### Program Output

```
I am starting in function main.
I am now inside the function deep.
I am now inside the function deeper.
Now I am back in deep.
Back in function main again.
```

In [Program 6-4](#), function `main` only calls the function `deep`. In turn, `deep` calls `deeper`. The paths taken by the program are shown in [Figure 6-5](#).

**Figure 6-5 Layered function calls**





6.1 Is the following a function header or a function call?

```
calcTotal();
```

6.2 Is the following a function header or a function call?

```
void showResults()
```

6.3 What will the output of the following program be if the user enters 10?

```
#include <iostream>
using namespace std;
void func1()
{
    cout << "Able was I\n";
}
void func2()
{
    cout << "I saw Elba\n";
}
int main()
{
    int input;
    cout << "Enter a number: ";
    cin >> input;
    if (input < 10)
    {
        func1();
        func2();
    }
    else
    {
        func2();
        func1();
    }
    return 0;
}
```

6.4 The following program skeleton determines whether a person qualifies for a credit card. To qualify, the person must have worked on his or her current job for at least 2 years, and make at least \$17,000 per year. Finish the program by writing the definitions of the functions `qualify` and `noQualify`. The function `qualify` should explain that the applicant qualifies for the card, and that the annual interest rate is 12 percent. The function `noQualify` should explain that the applicant does not qualify for the card and give a general explanation why.

```
#include <iostream>
using namespace std;
// You must write definitions for the two functions qualify
// and noQualify.
int main()
{
    double salary;
    int years;
    cout << "This program will determine if you qualify\n";
    cout << "for our credit card.\n";
    cout << "What is your annual salary? ";
    cin >> salary;
    cout << "How many years have you worked at your ";
    cout << "current job? ";
    cin >> years;
    if (salary >= 17000.0 && years >= 2)
        qualify();
    else
        noQualify();
    return 0;
}
```

## 6.3 Function Prototypes

### Concept:

A function prototype eliminates the need to place a function definition before all calls to the function.

Before the compiler encounters a call to a particular function, it must already know the function's return type, the number of parameters it uses, and the type of each parameter. (You will learn how to use parameters in the next section.)

One way of ensuring that the compiler has this information is to place the function definition before all calls to that function. This was the approach taken in [Programs 6-1](#), [6-2](#), [6-3](#), and [6-4](#).

Another method is to declare the function with a *function prototype*. Here is a prototype for the `displayMessage` function in [Program 6-1](#):

```
void displayMessage();
```

The prototype looks similar to the function header, except there is a semicolon at the end. The statement above tells the compiler that the function `displayMessage` has a `void` return type (it doesn't return a value) and uses no parameters.





### Note:

Function prototypes are also known as *function declarations*.



### Warning!

You must place either the function definition or the function prototype ahead of all calls to the function. Otherwise, the program will not compile.

Function prototypes are usually placed near the top of a program so the compiler will encounter them before any function calls. **Program 6-5**  is a modification of **Program 6-3** . The definitions of the functions `first` and `second` have been placed after `main`, and a function prototype has been placed after the `using namespace std` statement.

## Program 6-5

```
1 // This program has three functions: main,  
first, and second.  
2 #include <iostream>  
3 using namespace std;  
4  
5 // Function Prototypes  
6 void first();  
7 void second();  
8  
9 int main()  
10 {  
11     cout << "I am starting in function  
main.\n";  
12     first();    // Call function first  
13     second();  // Call function second  
14     cout << "Back in function main again.\n";  
15     return 0;  
16 }  
17  
18 //*****  
19 // Definition of function first.    *  
20 // This function displays a message. *  
21 //*****
```



```

22
23 void first()
24 {
25     cout << "I am now inside the function
first.\n";
26 }
27
28 //*****
29 // Definition of function second.      *
30 // This function displays a message.  *
31 //*****
32
33 void second()
34 {
35     cout << "I am now inside the function
second.\n";
36 }

```

## Program Output

(The program's output is the same as the output of [Program 6-3](#).)

When the compiler is reading [Program 6-5](#), it encounters the calls to the functions `first` and `second` in lines 12 and 13 before it has

read the definition of those functions. Because of the function prototypes, however, the compiler already knows the return type and parameter information of `first` and `second`.



**Note:**

Although some programmers make `main` the last function in the program, many prefer it to be first because it is the program's starting point.

## 6.4 Sending Data into a Function

### Concept:

When a function is called, the program may send values into the function.



### Functions and Arguments

Values sent into a function are called *arguments*. You're already familiar with how to use arguments in a function call. In the following statement, the function `pow` is being called and two arguments, 2.0 and 4.0, are passed to it:

```
result = pow(2.0, 4.0);
```

By using *parameters*, you can design your own functions that accept data this way. A parameter is a special variable that holds a value being passed into a function. Here is the definition of a function that uses a parameter:

```
void displayValue(int num)
{
    cout << "The value is " << num << endl;
}
```

Notice the integer variable definition inside the parentheses `(int num)`. The variable `num` is a parameter. This enables the function `displayValue` to accept an integer value as an argument.

**Program 6-6** is a complete program using this function.

**Note:**

In this text, the values that are passed into a function are called arguments, and the variables that receive those values are called parameters. There are several variations of these terms in use. Some call the arguments *actual parameters* and call the parameters *formal parameters*. Others use the terms *actual argument* and *formal argument*. Regardless of which set of terms you use, it is important to be consistent.

## Program 6-6

```
1 // This program demonstrates a function with a parameter.
2 #include <iostream>
3 using namespace std;
4
5 // Function Prototype
6 void displayValue(int);
7
8 int main()
9 {
10     cout << "I am passing 5 to displayValue.\n";
11     displayValue(5); // Call displayValue with argument 5
12     cout << "Now I am back in main.\n";
13     return 0;
14 }
15
16 //*****
17 // Definition of function displayValue. *
18 // It uses an integer parameter whose value is displayed.*
19 //*****
20
21 void displayValue(int num)
22 {
23     cout << "The value is " << num << endl;
24 }
```

## Program Output

```
I am passing 5 to displayValue.
The value is 5
Now I am back in main.
```

First, notice the function prototype for `displayValue` in line 6:

```
void displayValue(int);
```

It is not necessary to list the name of the parameter variable inside the parentheses. Only its data type is required. The function prototype shown above could optionally have been written as

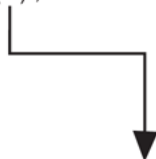
```
void displayValue(int num);
```

However, the compiler ignores the name of the parameter variable in the function prototype.

In `main`, the `displayValue` function is called with the argument 5 inside the parentheses. The number 5 is passed into `num`, which is `displayValue`'s parameter. This is illustrated in [Figure 6-6](#).

**Figure 6-6** An argument passed to a function

```
displayValue(5);  
  
void displayValue(int num)  
{  
    cout << "The value is " << num << endl;  
}
```



Any argument listed inside the parentheses of a function call is copied into the function's parameter variable. In essence, parameter variables are initialized to the value of their corresponding arguments.

[Program 6-7](#) shows the function `displayValue` being called several times with a different argument being passed each time.

## Program 6-7

```
1 // This program demonstrates a function with a parameter.
2 #include <iostream>
3 using namespace std;
4
5 // Function Prototype
6 void displayValue(int);
7
8 int main()
9 {
10     cout << "I am passing several values to displayValue.\n";
11     displayValue(5); // Call displayValue with argument 5
12     displayValue(10); // Call displayValue with argument 10
13     displayValue(2); // Call displayValue with argument 2
14     displayValue(16); // Call displayValue with argument 16
15     cout << "Now I am back in main.\n";
16     return 0;
17 }
18
19 //*****
20 // Definition of function displayValue. *
21 // It uses an integer parameter whose value is displayed.*
22 //*****
23
24 void displayValue(int num)
25 {
26     cout << "The value is " << num << endl;
27 }
```

## Program Output

```
I am passing several values to displayValue.  
The value is 5  
The value is 10  
The value is 2  
The value is 16  
Now I am back in main.
```

## Warning!

When passing a variable as an argument, simply write the variable name inside the parentheses of the function call. Do not write the data type of the argument variable in the function call. For example, the following function call will cause an error:

```
displayValue(int x); // Error!
```

The function call should appear as

```
displayValue(x); // Correct
```

Each time the function is called in [Program 6-7](#), `num` takes on a different value. Any expression whose value could normally be assigned to `num` may be used as an argument. For example, the following function call would pass the value 8 into `num`:

```
displayValue(3 + 5);
```

If you pass an argument whose type is not the same as the parameter's type, the argument will be promoted or demoted automatically. For instance, the argument in the following function call would be truncated, causing the value 4 to be passed to `num`:



```
displayValue(4.7);
```

Often, it's useful to pass several arguments into a function. [Program 6-8](#) shows the definition of a function with three parameters.

## Program 6-8

```
1 // This program demonstrates a function with three parameters.
2 #include <iostream>
3 using namespace std;
4
5 // Function Prototype
6 void showSum(int, int, int);
7
8 int main()
9 {
10     int value1, value2, value3;
11
12     // Get three integers.
13     cout << "Enter three integers and I will display ";
14     cout << "their sum: ";
15     cin >> value1 >> value2 >> value3;
16
17     // Call showSum passing three arguments.
18     showSum(value1, value2, value3);
19     return 0;
20 }
21
22 //*****
23 // Definition of function showSum. *
24 // It uses three integer parameters. Their sum is displayed.*
25 //*****
26
27 void showSum(int num1, int num2, int num3)
28 {
29     cout << (num1 + num2 + num3) << endl;
30 }
```

**Program Output with Example Input Shown in Bold**

```
Enter three integers and I will display their sum: 4 8 7 Enter  
19
```

In the function header for `showSum`, the parameter list contains three variable definitions separated by commas:

```
void showSum(int num1, int num2, int num3)
```

### Warning!

Each parameter variable in a parameter list must have a data type listed before its name. For example, a compiler error would occur if the parameter list for the `showSum` function were defined as shown in the following header:


```
void showSum(int num1, num2, num3) // Error!
```

A data type for all three of the parameter variables must be listed, as shown here:

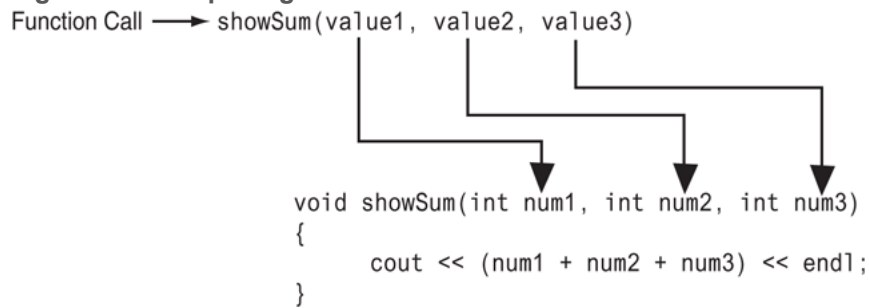
```
void showSum(int num1, int num2, int num3) // Correct
```

In the function call in line 18, the variables `value1`, `value2`, and `value3` are passed as arguments:

```
showSum(value1, value2, value3);
```

When a function with multiple parameters is called, the arguments are passed to the parameters in order. This is illustrated in [Figure 6-7](#) .

**Figure 6-7 Multiple arguments**



The following function call will cause 5 to be passed into the `num1` parameter, 10 to be passed into `num2`, and 15 to be passed into `num3`:

```
showSum(5, 10, 15);
```

However, the following function call will cause 15 to be passed into the `num1` parameter, 5 to be passed into `num2`, and 10 to be passed into `num3`:

```
showSum(15, 5, 10);
```



**Note:**

The function prototype must list the data type of each parameter.




**Note:**

Like all variables, parameters have a scope. The scope of a parameter is limited to the body of the function that uses it.

## 6.5 Passing Data by Value

### **Concept:**

When an argument is passed into a parameter, only a copy of the argument's value is passed. Changes to the parameter do not affect the original argument.

As you've seen in this chapter, parameters are special-purpose variables that are defined inside the parentheses of a function definition. They are separate and distinct from the arguments that are listed inside the parentheses of a function call. The values that are stored in the parameter variables are copies of the arguments. Normally, when a parameter's value is changed inside a function, it has no effect on the original argument. **Program 6-9**  demonstrates this concept.

## Program 6-9

```
1 // This program demonstrates that changes to a
function parameter
2 // have no effect on the original argument.
3 #include <iostream>
4 using namespace std;
5
6 // Function Prototype
7 void changeMe(int);
8
9 int main()
10 {
11     int number = 12;
12
13     // Display the value in number.
14     cout << "number is " << number << endl;
15
16     // Call changeMe, passing the value in
number
17     // as an argument.
18     changeMe(number);
19
20     // Display the value in number again.
21     cout << "Now back in main again, the value
```

```

of ";
22     cout << "number is " << number << endl;
23     return 0;
24 }
25
26
//*****
*****
27 // Definition of function changeMe.
    *
28 // This function changes the value of the
parameter myValue.    *
29
//*****
*****
30
31 void changeMe(int myValue)
32 {
33     // Change the value of myValue to 0.
34     myValue = 0;
35
36     // Display the value in myValue.
37     cout << "Now the value is " << myValue <<
endl;
38 }


```

## Program Output

```
number is 12  
Now the value is 0  
Now back in main again, the value of number  
is 12
```

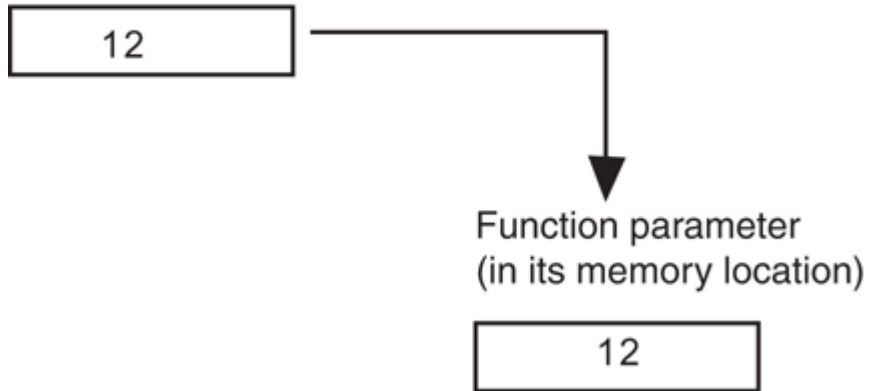
Even though the parameter variable `myValue` is changed in the `changeMe` function, the argument `number` is not modified. The `myValue` variable contains only a copy of the `number` variable.

The `changeMe` function does not have access to the original argument. When only a copy of an argument is passed to a function, it is said to be *passed by value*. This is because the function receives a copy of the argument's value and does not have access to the original argument.

**Figure 6-8**  illustrates that a parameter variable's storage location in memory is separate from that of the original argument.



**Figure 6-8 The argument and the parameter are separate**  
Original argument  
(in its memory location)



**Note:**

Later in this chapter, you will learn ways to give a function access to its original arguments.

## 6.6 Focus on Software Engineering: Using Functions in a Menu-Driven Program

### Concept:

Functions are ideal for use in menu-driven programs. When the user selects an item from a menu, the program can call the appropriate function.

In [Chapters 4](#) and [5](#), you saw a menu-driven program that calculates the charges for a health club membership. [Program 6-10](#) shows the program redesigned as a modular program. A *modular* program is broken up into functions that perform specific tasks.

## Program 6-10

```
1 // This is a menu-driven program that makes a
function call
2 // for each selection the user makes.
3 #include <iostream>
4 #include <iomanip>
5 using namespace std;
6
7 // Function prototypes
8 void showMenu();
9 void showFees(double, int);
10
11 int main()
12 {
13     int choice;        // To hold a menu choice
14     int months;       // To hold a number of
months
15
16     // Constants for the menu choices
17     const int ADULT_CHOICE = 1,
18             CHILD_CHOICE = 2,
19             SENIOR_CHOICE = 3,
20             QUIT_CHOICE = 4;
21
```

```
22     // Constants for membership rates
23     const double ADULT = 40.0,
24             CHILD = 20.0;
25             SENIOR = 30.0,
26
27     // Set up numeric output formatting.
28     cout << fixed << showpoint <<
29     setprecision(2);
30     do
31     {
32         // Display the menu and get the user's
33         choice.
34         showMenu();
35         cin >> choice;
36
37         // Validate the menu selection.
38         while (choice < ADULT_CHOICE || choice
39         > QUIT_CHOICE)
40         {
41             cout << "Please enter a valid menu
42             choice: ";
43             cin >> choice;
44         }
45
46         // If the user does not want to quit,
47         proceed.
48         if (choice != QUIT_CHOICE)
```



```

//*****
*****
70
71 void showMenu()
72 {
73     cout << "\n\t\tHealth Club Membership
Menu\n\n"
74         << "1. Standard Adult Membership\n"
75         << "2. Child Membership\n"
76         << "3. Senior Citizen Membership\n"
77         << "4. Quit the Program\n\n"
78         << "Enter your choice: ";
79 }
80
81
//*****
*****
82 // Definition of function showFees. The
memberRate parameter holds *
83 // the monthly membership rate and the months
parameter holds the *
84 // number of months. The function displays the
total charges. *
85
//*****
*****
86
87 void showFees(double memberRate, int months)

```

```
88 {  
89     cout << "The total charges are $"  
90         << (memberRate * months) << endl;  
91 }
```

**Program Output with Example Input Shown in Bold**

### Health Club Membership Menu

1. Standard Adult Membership
2. Child Membership
3. Senior Citizen Membership
4. Quit the Program

Enter your choice: **1** Enter

For how many months? **12** Enter

The total charges are \$480.00

### Health Club Membership Menu

1. Standard Adult Membership
2. Child Membership
3. Senior Citizen Membership
4. Quit the Program

Enter your choice: **4** Enter

Let's take a closer look at this program. First notice the `showMenu` function in lines 71 through 79. This function displays the menu and is called from the `main` function in line 33.



The `showFees` function appears in lines 87 through 91. Its purpose is to display the total fees for a membership lasting a specified number of months. The function accepts two arguments: the monthly membership fee (a `double`) and the number of months of membership (an `int`). The function uses these values to calculate and display the total charges. For example, if we wanted the function to display the fees for an adult membership lasting 6 months, we would pass the `ADULT` constant as the first argument, and 6 as the second argument.

The `showFees` function is called from three different locations in the `switch` statement, which is in the `main` function. The first location is line 54. This statement is executed when the user has selected item 1, standard adult membership, from the menu. The `showFees` function is called with the `ADULT` constant and the `months` variable passed as arguments. The second location is line 57. This statement is executed when the user has selected item 2, child membership, from the menu. The `showFees` function is called in this line with the `CHILD` constant and the `months` variable passed as arguments. The third location is line 60. This statement is executed when the user has selected item 3, senior citizen membership, from the menu. The `showFees` function is called with the `SENIOR` constant and the `months` variable passed as arguments. Each time the `showFees` function is called, it displays the total membership fees for the specified type of membership, for the specified number of months.



# Checkpoint

6.5 Indicate which of the following is the function prototype, the function header, and the function call:

```
void showNum(double num)
void showNum(double);
showNum(45.67);
```

6.6 Write a function named `timesTen`. The function should have an integer parameter named `number`. When `timesTen` is called, it should display the product of `number` times ten.

(*Note:* Just write the function. Do not write a complete program.)

6.7 Write a function prototype for the `timesTen` function you wrote in Question 6.6.

6.8 What is the output of the following program?

```
#include <iostream>
using namespace std;
void showDouble(int); // Function prototype
int main()
{
    int num;
    for (num = 0; num < 10; num++)
        showDouble(num);
    return 0;
}
// Definition of function showDouble.
void showDouble(int value)
{
    cout << value << "\t" << (value * 2) << endl;
}
```

6.9 What is the output of the following program?

```

#include <iostream>

using namespace std;

void func1(double, int); // Function prototype

int main()
{
    int x = 0;
    double y = 1.5;
    cout << x << " " << y << endl;
    func1(y, x);
    cout << x << " " << y << endl;
    return 0;
}

void func1(double a, int b)
{
    cout << a << " " << b << endl;
    a = 0.0;
    b = 10;
    cout << a << " " << b << endl;
}

```

6.10 The following program skeleton asks for the number of hours you've worked and your hourly pay rate. It then calculates and displays your wages. The function `showDollars`, which you are to write, formats the output of the wages.

```
#include <iostream>

using namespace std;

void showDollars(double); // Function prototype

int main()
{
    double payRate, hoursWorked, wages;

    cout << "How many hours have you worked? "
    cin >> hoursWorked;

    cout << "What is your hourly pay rate? ";
    cin >> payRate;

    wages = hoursWorked * payRate;

    showDollars(wages);

    return 0;
}

// You must write the definition of the function
showDollars
// here. It should take one parameter of the type double.
// The function should display the message "Your wages are
$"
// followed by the value of the parameter. It should be
displayed
// with 2 places of precision after the decimal point, in
fixed
// notation, and the decimal point should always display.
```

## 6.7 The `return` Statement

### Concept:

The `return` statement causes a function to end immediately.

When the last statement in a `void` function has finished executing, the function terminates and the program returns to the statement following the function call. It's possible, however, to force a function to return before the last statement has been executed. When the `return` statement is encountered, the function immediately terminates and control of the program returns to the statement that called the function. This is demonstrated in [Program 6-11](#). The function `divide` shows the quotient of `arg1` divided by `arg2`. If `arg2` is set to zero, the function returns.

## Program 6-11

```
1 // This program uses a function to perform
division. If division
2 // by zero is detected, the function returns.
3 #include <iostream>
4 using namespace std;
5
6 // Function prototype.
7 void divide(double, double);
8
9 int main()
10 {
11     double num1, num2;
12
13     cout << "Enter two numbers and I will
divide the first\n";
14     cout << "number by the second number: ";
15     cin >> num1 >> num2;
16     divide(num1, num2);
17     return 0;
18 }
19
20
//*****
```

```

*****
21 // Definition of function divide.
   *
22 // Uses two parameters: arg1 and arg2. The
function divides arg1 *
23 // by arg2 and shows the result. If arg2 is
zero, however, the *
24 // function returns.
   *
25
//*****
*****
26
27 void divide(double arg1, double arg2)
28 {
29     if (arg2 == 0.0)
30     {
31         cout << "Sorry, I cannot divide by
zero.\n";
32         return;
33     }
34     cout << "The quotient is " << (arg1 /
arg2) << endl;
35 }

```

**Program Output with Example Input Shown in Bold**



```
Enter two numbers and I will divide the  
first  
number by the second number: 12 0 Enter  
Sorry, I cannot divide by zero.
```

In the example running of the program, the user entered 12 and 0 as input. In line 16, the `divide` function was called, passing 12 into the `arg1` parameter and 0 into the `arg2` parameter. Inside the `divide` function, the `if` statement in line 29 executes. Because `arg2` is equal to 0.0, the code in lines 31 and 32 executes. When the `return` statement in line 32 executes, the `divide` function immediately ends. This means the `cout` statement in line 34 does not execute. The program resumes at line 17 in the `main` function.

## 6.8 Returning a Value from a Function

### Concept:

A function may send a value back to the part of the program that called the function.

You've seen that data may be passed into a function by way of parameter variables. Data may also be returned from a function, back to the statement that called it. Functions that return a value are appropriately known as *value-returning functions*.



### Value-Returning Functions

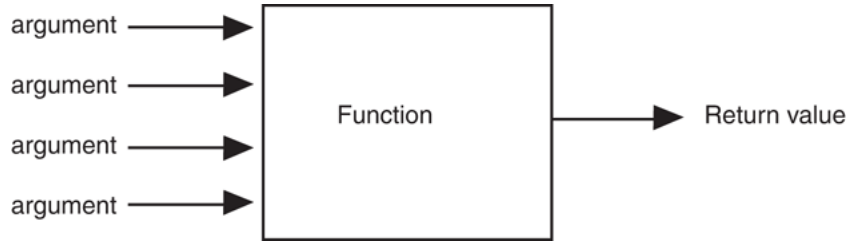
The `pow` function, which you have already seen, is an example of a value-returning function. Here is an example:

```
double x;  
x = pow(4.0, 2.0);
```

The second line in this code calls the `pow` function, passing 4.0 and 2.0 as arguments. The function calculates the value of 4.0 raised to the power of 2.0 and returns that value. The value, which is 16.0, is assigned to the `x` variable by the `=` operator.

Although several arguments may be passed into a function, only one value may be returned from it. Think of a function as having multiple communication channels for receiving data (parameters), but only one channel for sending data (the return value). This is illustrated in [Figure 6-9](#).

**Figure 6-9 A function returns one value**



**Note:**

It is possible to return multiple values from a function, but they must be “packaged” in such a way that they are treated as a single value. This will be a topic in [Chapter 11](#).

# Defining a Value-Returning Function

When you are writing a value-returning function, you must decide what type of value the function will return. This is because you must specify the data type of the return value in the function header and in the function prototype. Recall that a `void` function, which does not return a value, uses the key word `void` as its return type in the function header. A value-returning function will use `int`, `double`, `bool`, or any other valid data type in its header. Here is an example of a function that returns an `int` value:

```
int sum(int num1, int num2)
{
    int result;
    result = num1 + num2;
    return result;
}
```

The name of this function is `sum`. Notice in the function header the return type is `int`, as illustrated in [Figure 6-10](#).

**Figure 6-10** Function return type

Return type

↓  
int sum(int num1, int num2)

This code defines a function named `sum` that accepts two `int` arguments. The arguments are passed into the parameter variables `num1` and `num2`. Inside the function, a variable, `result`, is defined.

Variables that are defined inside a function are called *local variables*. After the variable definition, the parameter variables `num1` and `num2` are added, and their sum is assigned to the `result` variable. The last statement in the function is

```
return result;
```

This statement causes the function to end, and it sends the value of the `result` variable back to the statement that called the function. A value-returning function must have a `return` statement written in the following general format:

```
return expression;
```

In the general format, `expression` is the value to be returned. It can be any expression that has a value, such as a variable, literal, or mathematical expression. The value of the expression is converted to the data type that the function returns, and is sent back to the statement that called the function. In this case, the `sum` function returns the value in the `result` variable.

However, we could have eliminated the `result` variable and returned the expression `num1 + num2`, as shown in the following code:

```
int sum(int num1, int num2)
{
    return num1 + num2;
}
```

When writing the prototype for a value-returning function, follow the same conventions we have covered earlier. Here is the prototype for the `sum` function:

```
int sum(int, int);
```

# Calling a Value-Returning Function

**Program 6-12**  shows an example of how to call the `sum` function.

## Program 6-12

```
1 // This program uses a function that returns a value.
2 #include <iostream>
3 using namespace std;
4
5 // Function prototype
6 int sum(int, int);
7
8 int main()
9 {
10     int value1 = 20, // The first value
11         value2 = 40, // The second value
12         total;      // To hold the total
13
14     // Call the sum function, passing the contents of
15     // value1 and value2 as arguments. Assign the return
16     // value to the total variable.
17     total = sum(value1, value2);
18
19     // Display the sum of the values.
20     cout << "The sum of " << value1 << " and "
21         << value2 << " is " << total << endl;
22     return 0;
23 }
24
25 //*****
26 // Definition of function sum. This function returns *
27 // the sum of its two parameters. *
28 //*****
29
30 int sum(int num1, int num2)
31 {
32     return num1 + num2;
33 }
```

## Program Output

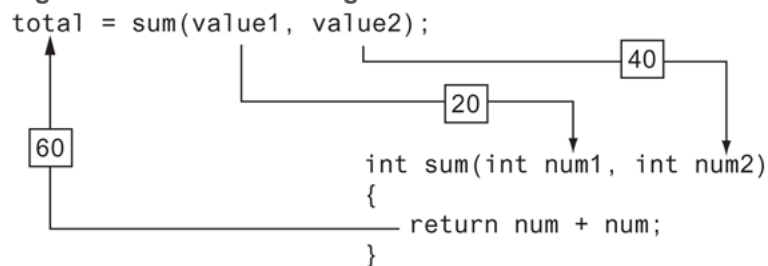
```
The sum of 20 and 40 is 60
```

Here is the statement in line 17 that calls the `sum` function, passing `value1` and `value2` as arguments:

```
total = sum(value1, value2);
```

This statement assigns the value returned by the `sum` function to the `total` variable. In this case, the function will return 60. [Figure 6-11](#) shows how the arguments are passed into the function, and how a value is passed back from the function.

**Figure 6-11 A function's arguments and return value**



When you call a value-returning function, you usually want to do something meaningful with the value it returns. [Program 6-12](#) shows a function's return value being assigned to a variable. This is commonly how return values are used, but you can do many other things with them. For example, the following code shows a mathematical expression that uses a call to the `sum` function:

```
int x = 10, y = 15;
double average;
average = sum(x, y) / 2.0;
```

In the last statement, the `sum` function is called with `x` and `y` as its arguments. The function's return value, which is 25, is divided by 2.0. The result, 12.5, is assigned to `average`. Here is another example:

```
int x = 10, y = 15;
cout << "The sum is " << sum(x, y) << endl;
```



This code sends the `sum` function's return value to `cout` so it can be displayed on the screen. The message "The sum is 25" will be displayed.

Remember, a value-returning function returns a value of a specific data type. You can use the function's return value anywhere that you can use a regular value of the same data type. This means anywhere an `int` value can be used, a call to an `int` value-returning function can be used. Likewise, anywhere a `double` value can be used, a call to a `double` value-returning function can be used. The same is true for all other data types.

Let's look at another example. [Program 6-13](#), which calculates the area of a circle, has two functions in addition to `main`. One of the functions is named `square`, and it returns the square of any number passed to it as an argument. The `square` function is called in a mathematical statement. The program also has a function named `getRadius`, which prompts the user to enter the circle's radius. The value entered by the user is returned from the function.

## Program 6-13

```
1 // This program demonstrates two value-returning functions.
2 // The square function is called in a mathematical statement.
3 #include <iostream>
4 #include <iomanip>
5 using namespace std;
6
7 //Function prototypes
8 double getRadius();
9 double square(double);
10
11 int main()
12 {
13     const double PI = 3.14159; // Constant for pi
14     double radius;           // To hold the circle's radius
15     double area;           // To hold the circle's area
16
17     // Set the numeric output formatting.
18     cout << fixed << showpoint << setprecision(2);
19
20     // Get the radius of the circle.
21     cout << "This program calculates the area of ";
22     cout << "a circle.\n";
23     radius = getRadius();
24
25     // Calculate the area of the circle.
26     area = PI * square(radius);
27
28     // Display the area.
29     cout << "The area is " << area << endl;
30     return 0;
31 }
32
33 //*****
34 // Definition of function getRadius. *
35 // This function asks the user to enter the radius of *
36 // the circle and then returns that number as a double.*
37 //*****
```

```

38
39 double getRadius()
40 {
41     double rad;
42
43     cout << "Enter the radius of the circle: ";
44     cin >> rad;
45     return rad;
46 }
47
48 //*****
49 // Definition of function square. *
50 // This function accepts a double argument and returns *
51 // the square of the argument as a double. *
52 //*****
53
54 double square(double number)
55 {
56     return number * number;
57 }

```

### Program Output with Example Input Shown in Bold

```

This program calculates the area of a circle.
Enter the radius of the circle: 10 Enter
The area is 314.16

```

First, look at the `getRadius` function defined in lines 39 through 46. The purpose of the function is to prompt the user to enter the radius of a circle. In line 41, the function defines a local variable, `rad`. Lines 43 and 44 prompt the user to enter the circle's radius, which is stored in the `rad` variable. In line 45, the value of the `rad` value is returned. The `getRadius` function is called in the `main` function, in line 23. The value that is returned from the function is assigned to the `radius` variable.

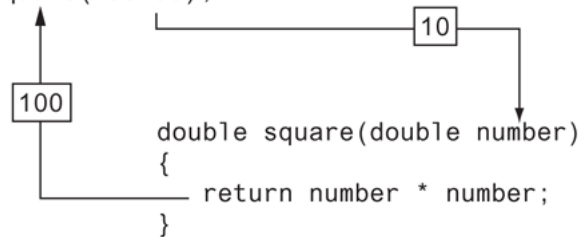
Next, look at the `square` function, which is defined in lines 54 through 57. When the function is called, a `double` argument is passed to it. The function stores the argument in the `number` parameter. The `return` statement in line 56 returns the value of the expression `number * number`, which is the square of the `number` parameter. The `square` function is called in the `main` function, in line 26, with the value of

`radius` passed as an argument. The function will return the square of the `radius` variable, and that value will be used in the mathematical expression.

Assuming the user has entered 10 as the radius, and this value is passed as an argument to the `square` function, the `square` function will return the value 100. [Figure 6-12](#) illustrates how the value 100 is passed back to the mathematical expression in line 26. The value 100 will then be used in the mathematical expression.

**Figure 6-12** The `square` function

```
area = PI * square(radius);
```



Functions can return values of any type. Both the `getRadius` and `square` functions in [Program 6-13](#) return a `double`. The `sum` function you saw in [Program 6-12](#) returned an `int`. When a statement calls a value-returning function, it should properly handle the return value. For example, if you assign the return value of the `square` function to a variable, the variable should be a `double`. If the return value of the function has a fractional portion and you assign it to an `int` variable, the value will be truncated.



## In the Spotlight:

### Using Functions

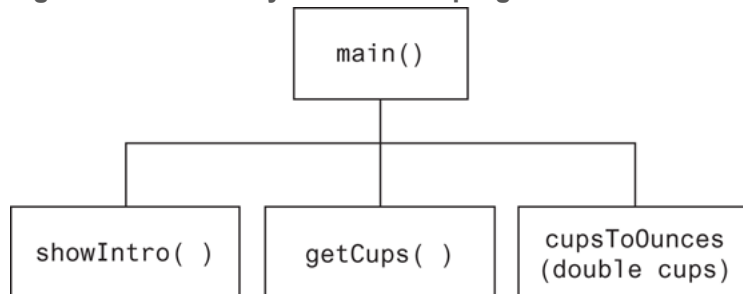
Your friend Michael runs a catering company. Some of the ingredients that his recipes require are measured in cups. When he goes to the grocery store to buy those ingredients, however, they are sold only by the fluid ounce. He has asked you to write a simple program that converts cups to fluid ounces.

You design the following algorithm:

1. *Display an introductory screen that explains what the program does.*
2. *Get the number of cups.*
3. *Convert the number of cups to fluid ounces and display the result.*

This algorithm lists the top level of tasks that the program needs to perform and becomes the basis of the program's `main` function. The hierarchy chart shown in [Figure 6-13](#) shows how the program will be broken down into functions.

**Figure 6-13** Hierarchy chart for the program



As shown in the hierarchy chart, the `main` function will call three other functions. Here are summaries of those functions:

- `showIntro`—This function will display a message on the screen that explains what the program does.
- `getCups`—This function will prompt the user to enter the number of cups, then will return that value as a `double`.
- `cupsToOunces`—This function will accept the number of cups as an argument, then return an equivalent number of fluid ounces as a `double`.

[Program 6-14](#) shows the code for the program.

## Program 6-14

```
1 // This program converts cups to fluid ounces.
2 #include <iostream>
3 #include <iomanip>
4 using namespace std;
5
6 // Function prototypes
7 void showIntro();
8 double getCups();
9 double cupsToOunces(double);
10
11 int main()
12 {
13     // Variables for the cups and ounces.
14     double cups, ounces;
15
16     // Set up numeric output formatting.
17     cout << fixed << showpoint << setprecision(1);
18
19     // Display an intro screen.
20     showIntro();
21
22     // Get the number of cups.
23     cups = getCups();
24
25     // Convert cups to fluid ounces.
26     ounces = cupsToOunces(cups);
27
28     // Display the number of ounces.
29     cout << cups << " cups equals "
30         << ounces << " ounces.\n";
31
32     return 0;
33 }
34
35 //*****
36 // The showIntro function displays an *
```

```

37 // introductory screen. *
38 //*****
39
40 void showIntro()
41 {
42     cout << "This program converts measurements\n"
43         << "in cups to fluid ounces. For your\n"
44         << "reference the formula is:\n"
45         << " 1 cup = 8 fluid ounces\n\n";
46 }
47
48 //*****
49 // The getCups function prompts the user *
50 // to enter the number of cups and then *
51 // returns that value as a double. *
52 //*****
53
54 double getCups()
55 {
56     double numCups;
57
58     cout << "Enter the number of cups: ";
59     cin >> numCups;
60     return numCups;
61 }
62
63 //*****
64 // The cupsToOunces function accepts a *
65 // number of cups as an argument and *
66 // returns the equivalent number of fluid *
67 // ounces as a double. *
68 //*****
69
70 double cupsToOunces(double numCups)
71 {
72     return numCups * 8.0;
73 }

```

**Program Output with Example Input Shown in Bold**

This program converts measurements  
in cups to fluid ounces. For your  
reference the formula is:

1 cup = 8 fluid ounces

Enter the number of cups: **2** Enter  
2.0 cups equals 16.0 ounces.



## 6.9 Returning a Boolean Value

### Concept:

Functions may return `true` or `false` values.


Frequently, there is a need for a function that tests an argument and returns a `true` or `false` value indicating whether or not a condition exists. Such a function would return a `bool` value. For example, the following function accepts an `int` argument and returns `true` if the argument is within the range of 1 through 100, or `false` otherwise:

```
bool isValid(int number)
{
    bool status;
    if (number >= 1 && number <= 100)
        status = true;
    else
        status = false;
    return status;
}
```

The following code shows an `if/else` statement that uses a call to the function:

```
int value = 20;
if (isValid(value))
    cout << "The value is within range.\n";
else
    cout << "The value is out of range.\n";
```

When this code executes, the message “The value is within range.” will be displayed.

**Program 6-15**  shows another example. This program has a function named `isEven` which returns `true` if its argument is an even number. Otherwise, the function returns `false`.

## Program 6-15

```
1 // This program uses a function that returns
true or false.
2 #include <iostream>
3 using namespace std;
4
5 // Function prototype
6 bool isEven(int);
7
8 int main()
9 {
10     int val;
11
12     // Get a number from the user.
13     cout << "Enter an integer and I will tell
you ";
14     cout << "if it is even or odd: ";
15     cin >> val;
16
17     // Indicate whether it is even or odd.
18     if (isEven(val))
19         cout << val << " is even.\n";
20     else
21         cout << val << " is odd.\n";
```

```
22     return 0;
23 }
24
25
26 //*****
27 // Definition of function isEven. This
28 // function accepts an
29 // integer argument and tests it to be even or
30 // odd. The function
31 // returns true if the argument is even or
32 // false if the argument
33 // is odd. The return value is a bool.
34 *
35
36 //*****
37 *****
38
39 bool isEven(int number)
40 {
41     bool status;
42
43     if (number % 2 == 0)
44         status = true; // The number is even
45         if there is no remainder.
46     else
47         status = false; // Otherwise, the
```

```
number is odd.  
40     return status;  
41 }
```

## Program Output with Example Input Shown in Bold

```
Enter an integer and I will tell you if it  
is even or odd: 5 Enter  
5 is odd.
```

The `isEven` function is called in line 18, in the following statement:

```
if (isEven(val))
```

When the `if` statement executes, `isEven` is called with `val` as its argument. If `val` is even, `isEven` returns `true`; otherwise, it returns `false`.



# Checkpoint

6.11 How many return values may a function have?

6.12 Write a header for a function named `distance`. The function should return a `double` and have two `double` parameters: `rate` and `time`.

6.13 Write a header for a function named `days`. The function should return an `int` and have three `int` parameters: `years`, `months`, and `weeks`.

6.14 Write a header for a function named `getKey`. The function should return a `char` and use no parameters.

6.15 Write a header for a function named `lightYears`. The function should return a `long` and have one `long` parameter: `miles`.

## 6.10 Local and Global Variables

**Concept:**

A local variable is defined inside a function and is not accessible outside the function. A global variable is defined outside all functions and is accessible to all functions in its scope.

# Local Variables

Variables defined inside a function are *local* to that function. They are hidden from the statements in other functions, which normally cannot access them. [Program 6-16](#) shows that because the variables defined in a function are hidden, other functions may have separate, distinct variables with the same name.



## Program 6-16

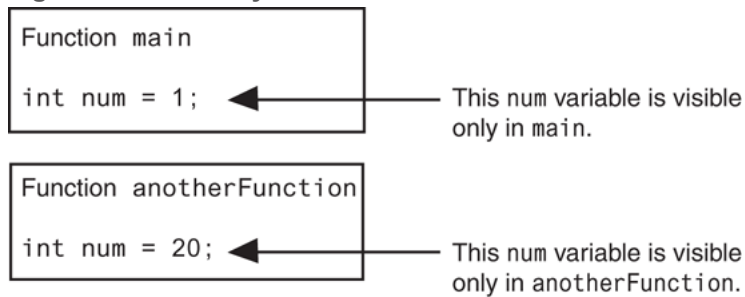
```
1 // This program shows that variables defined in a function
2 // are hidden from other functions.
3 #include <iostream>
4 using namespace std;
5
6 void anotherFunction(); // Function prototype
7
8 int main()
9 {
10     int num = 1; // Local variable
11
12     cout << "In main, num is " << num << endl;
13     anotherFunction();
14     cout << "Back in main, num is " << num << endl;
15     return 0;
16 }
17
18 //*****
19 // Definition of anotherFunction *
20 // It has a local variable, num, whose initial value *
21 // is displayed. *
22 //*****
23
24 void anotherFunction()
25 {
26     int num = 20; // Local variable
27
28     cout << "In anotherFunction, num is " << num << endl;
29 }
```

## Program Output

```
In main, num is 1
In anotherFunction, num is 20
Back in main, num is 1
```

Even though there are two variables named `num`, the program can only “see” one of them at a time because they are in different functions. When the program is executing in `main`, the `num` variable defined in `main` is visible. When `anotherFunction` is called, however, only variables defined inside it are visible, so the `num` variable in `main` is hidden. **Figure 6-14** illustrates the closed nature of the two functions. The boxes represent the scope of the variables.

**Figure 6-14** Visibility of local variables



## Local Variable Lifetime

A function’s local variables exist only while the function is executing. This is known as the *lifetime* of a local variable. When the function begins, its local variables and its parameter variables are created in memory, and when the function ends, the local variables and parameter variables are destroyed. This means that any value stored in a local variable is lost between calls to the function in which the variable is declared.

# Initializing Local Variables with Parameter Values

It is possible to use a parameter variable to initialize a local variable. Sometimes this simplifies the code in a function. For example, recall the first version of the `sum` function we discussed earlier:


```
int sum(int num1, int num2)
{
    int result;
    result = num1 + num2;
    return result;
}
```

In the body of the function, the `result` variable is defined and then a separate assignment statement assigns `num1 + num2` to `result`. We can combine these statements into one, as shown in the following modified version of the function.

```
int sum(int num1, int num2)
{
    int result = num1 + num2;
    return result;
}
```

Because the scope of a parameter variable is the entire function in which it is declared, we can use parameter variables to initialize local variables.

# Global Variables

A global variable is any variable defined outside all the functions in a program. The scope of a global variable is the portion of the program from the variable definition to the end. This means a global variable can be accessed by all functions that are defined after the global variable is defined. **Program 6-17**  shows two functions, `main` and `anotherFunction`, that access the same global variable, `num`.

## Program 6-17

```
1 // This program shows that a global variable is visible
2 // to all the functions that appear in a program after
3 // the variable's declaration.
4 #include <iostream>
5 using namespace std;
6
7 void anotherFunction(); // Function prototype
8 int num = 2;           // Global variable
9
10 int main()
11 {
12     cout << "In main, num is " << num << endl;
13     anotherFunction();
14     cout << "Back in main, num is " << num << endl;
15     return 0;
16 }
17
18 //*****
19 // Definition of anotherFunction *
20 // This function changes the value of the *
21 // global variable num. *
22 //*****
23
24 void anotherFunction()
25 {
26     cout << "In anotherFunction, num is " << num << endl;
27     num = 50;
28     cout << "But, it is now changed to " << num << endl;
29 }
```

## Program Output

```
In main, num is 2
In anotherFunction, num is 2
But, it is now changed to 50
Back in main, num is 50
```

In [Program 6-17](#), `num` is defined outside of all the functions. Because its definition appears before the definitions of `main` and `anotherFunction`, both functions have access to it.

Unless you explicitly initialize numeric global variables, they are automatically initialized to zero. Global character variables are initialized to NULL.\* The variable `globalNum` in [Program 6-18](#) is never set to any value by a statement, but because it is global, it is automatically set to zero.

\*The NULL character is stored as ASCII code 0.

## Program 6-18

```
1 // This program has an uninitialized global variable.
2 #include <iostream>
3 using namespace std;
4
5 int globalNum; // Global variable, automatically set to zero
6
7 int main()
8 {
9     cout << "globalNum is " << globalNum << endl;
10    return 0;
11 }
```

### Program Output

```
globalNum is 0
```

Now that you've had a basic introduction to global variables, I must warn you to restrict your use of them. When beginning students first learn to write programs with multiple functions, they are sometimes tempted to make all their variables global. This is usually because global variables can be accessed by any function in the program without being passed as arguments. Although this approach might make a program easier to create, it usually causes problems later. The reasons are as follows:


- Global variables make debugging difficult. Any statement in a program can change the value of a global variable. If you find that the wrong value is being stored in a global variable, you have to track down every statement that accesses it to determine where the bad value is coming from. In a program with thousands of lines of code, this can be difficult.
- Functions that use global variables are usually dependent on those variables. If you want to use such a function in a different program, most likely you will have to redesign it so it does not rely on the global variable.
- Global variables make a program hard to understand. A global variable can be modified by any statement in the program. If you are to understand any part of the program that uses a global variable, you have to be aware of all the other parts of the program that access the global variable.

Because of this, you should not use global variables for the conventional purposes of storing, manipulating, and retrieving data. In most cases, you should declare variables locally and pass them as arguments to the functions that need to access them.

# Global Constants

Although you should try to avoid the use of global variables, it is generally permissible to use global constants in a program. A *global constant* is a named constant that is available to every function in a program. Because a global constant's value cannot be changed during the program's execution, you do not have to worry about the potential hazards that are associated with the use of global variables.

Global constants are typically used to represent unchanging values that are needed throughout a program. For example, suppose a banking program uses a named constant to represent an interest rate. If the interest rate is used in several functions, it is easier to create a global constant, rather than a local named constant in each function. This also simplifies maintenance. If the interest rate changes, only the declaration of the global constant has to be changed, instead of several local declarations.

**Program 6-19**  shows an example of how global constants might be used. The program calculates an employee's gross pay, including overtime. In addition to `main`, this program has two functions: `getBasePay` and `getOvertimePay`. The `getBasePay` function accepts the number of hours worked and returns the amount of pay for the non-overtime hours. The `getOvertimePay` function accepts the number of hours worked and returns the amount of pay for the overtime hours, if any.



## Program 6-19

```
1 // This program calculates gross pay.
2 #include <iostream>
3 #include <iomanip>
4 using namespace std;
5
6 // Global constants
7 const double PAY_RATE = 22.55; // Hourly pay rate
8 const double BASE_HOURS = 40.0; // Max non-overtime hours
9 const double OT_MULTIPLIER = 1.5; // Overtime multiplier
10
11 // Function prototypes
12 double getBasePay(double);
13 double getOvertimePay(double);
14
15 int main()
16 {
17     double hours, // Hours worked
18         basePay, // Base pay
19         overtime = 0.0, // Overtime pay
20         totalPay; // Total pay
21
22     // Get the number of hours worked.
23     cout << "How many hours did you work? ";
24     cin >> hours;
25
26     // Get the amount of base pay.
27     basePay = getBasePay(hours);
28
29     // Get overtime pay, if any.
30     if (hours > BASE_HOURS)
31         overtime = getOvertimePay(hours);
32
33     // Calculate the total pay.
34     totalPay = basePay + overtime;
35
36     // Set up numeric output formatting.
37     cout << setprecision(2) << fixed << showpoint;
```

```

38
39 // Display the pay.
40 cout << "Base pay: $" << basePay << endl
41 << "Overtime pay $" << overtime << endl
42 << "Total pay $" << totalPay << endl;
43 return 0;
44 }
45
46 //*****
47 // The getBasePay function accepts the number of *
48 // hours worked as an argument and returns the *
49 // employee's pay for non-overtime hours. *
50 //*****
51
52 double getBasePay(double hoursWorked)
53 {
54     double basePay; // To hold base pay
55
56     // Determine base pay.
57     if (hoursWorked > BASE_HOURS)
58         basePay = BASE_HOURS * PAY_RATE;
59     else
60         basePay = hoursWorked * PAY_RATE;
61
62     return basePay;
63 }
64
65 //*****
66 // The getOvertimePay function accepts the number *
67 // of hours worked as an argument and returns the *
68 // employee's overtime pay. *
69 //*****
70
71 double getOvertimePay(double hoursWorked)
72 {
73     double overtimePay; // To hold overtime pay
74
75     // Determine overtime pay.
76     if (hoursWorked > BASE_HOURS)
77     {
78         overtimePay = (hoursWorked - BASE_HOURS) *

```

```
79         PAY_RATE * OT_MULTIPLIER;
80     }
81     else
82         overtimePay = 0.0;
83
84     return overtimePay;
85 }
```

### Program Output with Example Input Shown in Bold

```
How many hours did you work? 48 Enter
Base pay: $902.00
Overtime pay: $270.60
Total pay: $1172.60
```

Let's take a closer look at the program. Three global constants are defined in lines 7, 8, and 9. The `PAY_RATE` constant is set to the employee's hourly pay rate, which is 22.55. The `BASE_HOURS` constant is set to 40, which is the number of hours an employee can work in a week without getting paid overtime. The `OT_MULTIPLIER` constant is set to 1.5, which is the pay rate multiplier for overtime hours. This means that the employee's hourly pay rate is multiplied by 1.5 for all overtime hours.

Because these constants are global and are defined before all of the functions in the program, all the functions may access them. For example, the `getBasePay` function accesses the `BASE_HOURS` constant in lines 57 and 58 and accesses the `PAY_RATE` constant in lines 58 and 60. The `getOvertimePay` function accesses the `BASE_HOURS` constant in lines 76 and 78, the `PAY_RATE` constant in line 79, and the `OT_MULTIPLIER` constant in line 79.

# Local and Global Variables with the Same Name

You cannot have two local variables with the same name in the same function. This applies to parameter variables as well. A parameter variable is, in essence, a local variable. So, you cannot give a parameter variable and a local variable in the same function the same name.

However, you can have a local variable or a parameter variable with the same name as a global variable, or a global constant. When you do, the name of the local or parameter variable *shadows* the name of the global variable or global constant. This means that the global variable or constant's name is hidden by the name of the local or parameter variable. For example, look at [Program 6-20](#). This program has a global constant named `BIRDS`, set to 500. The `california` function has a local constant named `BIRDS`, set to 10000.

## Program 6-20


```
1 // This program demonstrates how a local variable
2 // can shadow the name of a global constant.
3 #include <iostream>
4 using namespace std;
5
6 // Global constant.
7 const int BIRDS = 500;
8
9 // Function prototype
10 void california();
11
12 int main()
13 {
14     cout << "In main there are " << BIRDS
15         << " birds.\n";
16     california();
17     return 0;
18 }
19
20 //*****
21 // california function *
22 //*****
23
24 void california()
25 {
26     const int BIRDS = 10000;
27     cout << "In california there are " << BIRDS
28         << " birds.\n";
29 }
```

## Program Output

```
In main there are 500 birds.  
In california there are 10000 birds.
```

When the program is executing in the `main` function, the global constant `BIRDS`, which is set to 500, is visible. The `cout` statement in lines 14 and 15 displays “In main there are 500 birds.” (My apologies to folks living in Maine for the difference in spelling.) When the program is executing in the `california` function, however, the local constant `BIRDS` shadows the global constant `BIRDS`. When the `california` function accesses `BIRDS`, it accesses the local constant. That is why the `cout` statement in lines 27 and 28 displays “In california there are 10000 birds.”

## 6.11 Static Local Variables

If a function is called more than once in a program, the values stored in the function's local variables do not persist between function calls. This is because the local variables are destroyed when the function terminates, and are then re-created when the function starts again. This is shown in [Program 6-21](#) .

## Program 6-21

```
1 // This program shows that local variables do
not retain
2 // their values between function calls.
3 #include <iostream>
4 using namespace std;
5
6 // Function prototype
7 void showLocal();
8
9 int main()
10 {
11     showLocal();
12     showLocal();
13     return 0;
14 }
15
16
17 //*****
18 // Definition of function showLocal.
19 *
20 // The initial value of localNum, which is 5,
is displayed. *
```




```
19 // The value of localNum is then changed to 99
before the *
20 // function returns.
*
21
//*****
*****
22
23 void showLocal()
24 {
25     int localNum = 5; // Local variable
26
27     cout << "localNum is " << localNum <<
endl;
28     localNum = 99;
29 }
```

## Program Output

```
localNum is 5
localNum is 5
```

Even though in line 28, the last statement in the `showLocal` function stores 99 in `localNum`, the variable is destroyed when the function returns. The next time the function is called, `localNum` is re-created and initialized to 5 again.

Sometimes it's desirable for a program to "remember" what value is stored in a local variable between function calls. This can be accomplished by making the variable `static`. Static local variables are not destroyed when a function returns. They exist for the lifetime of the program, even though their scope is only the function in which they are defined. **Program 6-22**  demonstrates some characteristics of `static` local variables:

## Program 6-22

```
1 // This program uses a static local variable.
2 #include <iostream>
3 using namespace std;
4
5 void showStatic(); // Function prototype
6
7 int main()
8 {
9     // Call the showStatic function five
10    times.
11    for (int count = 0; count < 5; count++)
12        showStatic();
13    return 0;
14 }
15
16 //*****
17 // Definition of function showStatic.
18 //
19 // statNum is a static local variable. Its
20 // value is displayed *
21 // and then incremented just before the
```

```
function returns.      *
19
//*****
*****
20
21 void showStatic()
22 {
23     static int statNum;
24
25     cout << "statNum is " << statNum << endl;
26     statNum++;
27 }
```



## Program Output

```
statNum is 0
statNum is 1
statNum is 2
statNum is 3
statNum is 4
```

In line 26 of [Program 6-22](#), `statNum` is incremented in the `showStatic` function, and it retains its value between each function

call. Notice even though `statNum` is not explicitly initialized, it starts at zero. Like global variables, all `static` local variables are initialized to zero by default. (Of course, you can provide your own initialization value, if necessary.)

If you do provide an initialization value for a `static` local variable, the initialization only occurs once. This is because initialization normally happens when the variable is created, and `static` local variables are only created once during the running of a program.

**Program 6-23** , which is a slight modification of **Program 6-22** , illustrates this point.

## Program 6-23

```
1 // This program shows that a static local
variable is only
2 // initialized once.
3 #include <iostream>
4 using namespace std;
5
6 void showStatic(); // Function prototype
7
8 int main()
9 {
10     // Call the showStatic function five
times.
11     for (int count = 0; count < 5; count++)
12         showStatic();
13     return 0;
14 }
15
16
17 // *****
18 // Definition of function showStatic.
19 // *****
20 // statNum is a static local variable. Its
```

```
value is displayed *  
19 // and then incremented just before the  
function returns. *  
20  
//*****  
*****  
21  
22 void showStatic()  
23 {  
24     static int statNum = 5;  
25  
26     cout << "statNum is " << statNum << endl;  
27     statNum++;  
28 }
```

## Program Output

```
statNum is 5  
statNum is 6  
statNum is 7  
statNum is 8  
statNum is 9
```

Even though the statement that defines `statNum` in line 24 initializes it to 5, the initialization does not happen each time the function is called. If it did, the variable would not be able to retain its value between function calls.



# Checkpoint

6.16 What is the difference between a static local variable and a global variable?

6.17 What is the output of the following program?

```
#include <iostream>
using namespace std;
void myFunc(); // Function prototype
int main()
{
    int var = 100;
    cout << var << endl;
    myFunc();
    cout << var << endl;
    return 0;
}
// Definition of function myFunc
void myFunc()
{
    int var = 50;
    cout << var << endl;
}
```

6.18 What is the output of the following program?

```
#include <iostream>

using namespace std;

void showVar(); // Function prototype

int main()
{
    for (int count = 0; count < 10; count++)
        showVar();

    return 0;
}

// Definition of function showVar
void showVar()
{
    static int var = 10;

    cout << var << endl;

    var++;
}
```

## 6.12 Default Arguments

### Concept:

Default arguments are passed to parameters automatically if no argument is provided in the function call.

It's possible to assign *default arguments* to function parameters. A default argument is passed to the parameter when the actual argument is left out of the function call. The default arguments are usually listed in the function prototype. Here is an example:

```
void showArea(double = 20.0, double = 10.0);
```

Default arguments are literal values or constants with an = operator in front of them, appearing after the data types listed in a function prototype. Since parameter names are optional in function prototypes, the example prototype could also be declared as

```
void showArea(double length = 20.0, double width = 10.0);
```

In both example prototypes, the function `showArea` has two `double` parameters. The first is assigned the default argument 20.0, and the second is assigned the default argument 10.0. Here is the definition of the function:

```
void showArea(double length, double width)
{
    double area = length * width;
    cout << "The area is " << area << endl;
}
```

The default argument for `length` is 20.0, and the default argument for `width` is 10.0. Because both parameters have default arguments, they may optionally be omitted in the function call, as shown here:

```
showArea();
```

In this function call, both default arguments will be passed to the parameters. The parameter `length` will take the value 20.0 and `width` will take the value 10.0. The output of the function will be

```
The area is 200
```

The default arguments are only used when the actual arguments are omitted from the function call. In the call below, the first argument is specified, but the second is omitted:

```
showArea(12.0);
```

The value 12.0 will be passed to `length`, while the default value 10.0 will be passed to `width`. The output of the function will be

```
The area is 120
```

Of course, all the default arguments may be overridden. In the function call below, arguments are supplied for both parameters:

```
showArea(12.0, 5.5);
```

The output of the function call above will be

```
The area is 66
```



## Note:


If a function does not have a prototype, default arguments may be specified in the function header. The `showArea` function could be defined as follows:

```
void showArea(double length = 20.0, double width = 10.0)
{
    double area = length * width;
    cout << "The area is " << area << endl;
}
```



## Warning!

A function's default arguments should be assigned in the earliest occurrence of the function name. This will usually be the function prototype.

**Program 6-24**  uses a function that displays asterisks on the screen. Arguments are passed to the function specifying how many columns and rows of asterisks to display. Default arguments are provided to display one row of 10 asterisks.

## Program 6-24

```
1 // This program demonstrates default function
arguments.
2 #include <iostream>
3 using namespace std;
4
5 // Function prototype with default arguments
6 void displayStars(int = 10, int = 1);
7
8 int main()
9 {
10     displayStars(); // Use default values
for cols and rows.
11     cout << endl;
12     displayStars(5); // Use default value
for rows.
13     cout << endl;
14     displayStars(7, 3); // Use 7 for cols and
3 for rows.
15     return 0;
16 }
17
18
//*****
```



```

*****
19 // Definition of function displayStars.
*
20 // The default argument for cols is 10 and for
rows is 1.*
21 // This function displays a square made of
asterisks. *
22
//*****
*****
23
24 void displayStars(int cols, int rows)
25 {
26     // Nested loop. The outer loop controls
the rows
27     // and the inner loop controls the
columns.
28     for (int down = 0; down < rows; down++)
29     {
30         for (int across = 0; across < cols;
across++)
31             cout << "*";
32         cout << endl;
33     }
34 }

```

## Program Output

```
*****
```

```
*****
```

```
*****
```

```
*****
```

```
*****
```

Although C++'s default arguments are very convenient, they are not totally flexible in their use. When an argument is left out of a function call, all arguments that come after it must be left out as well. In the `displayStars` function in [Program 6-24](#), it is not possible to omit the argument for `cols` without also omitting the argument for `rows`. For example, the following function call would be illegal:

```
displayStars(, 3); // Illegal function call.
```

It's possible for a function to have some parameters with default arguments, and some without. For example, in the following function (which displays an employee's gross pay), only the last parameter has a default argument:

```

// Function prototype
void calcPay(int empNum, double payRate, double hours = 40.0);
// Definition of function calcPay
void calcPay(int empNum, double payRate, double hours)
{
    double wages;
    wages = payRate * hours;
    cout << fixed << showpoint << setprecision(2);
    cout << "Gross pay for employee number ";
    cout << empNum << " is " << wages << endl;
}

```

When calling this function, arguments must always be specified for the first two parameters (`empNum` and `payRate`) since they have no default arguments. Here are examples of valid calls:

```

calcPay(769, 15.75); // Use default arg for 40 hours
calcPay(142, 12.00, 20); // Specify number of hours

```

When a function uses a mixture of parameters with and without default arguments, the parameters with default arguments must be defined last. In the `calcPay` function, `hours` could not have been defined before either of the other parameters. The following prototypes are illegal:

```
// Illegal prototype  
void calcPay(int empNum, double hours = 40.0, double payRate);  
  
// Illegal prototype  
void calcPay(double hours = 40.0, int empNum, double payRate);
```

Here is a summary of the important points about default arguments:

- The value of a default argument must be a literal value or a named constant.
- When an argument is left out of a function call (because it has a default value), all the arguments that come after it must be left out too.
- When a function has a mixture of parameters both with and without default arguments, the parameters with default arguments must be declared last.

## 6.13 Using Reference Variables as Parameters

### **Concept:**

When used as parameters, reference variables allow a function to access the parameter's original argument. Changes to the parameter are also made to the argument.

Earlier you saw that arguments are normally passed to a function by value, and that the function cannot change the source of the argument. C++ provides a special type of variable called a *reference variable* that, when used as a function parameter, allows access to the original argument.

A reference variable is an alias for another variable. Any changes made to the reference variable are actually performed on the variable for which it is an alias. By using a reference variable as a parameter, a function may change a variable that is defined in another function.

Reference variables are defined like regular variables, except you place an ampersand (&) in front of the name. For example, the following function definition makes the parameter `refVar` a reference variable:

```
void doubleNum(int &refVar)
{
    refVar *= 2;
}
```



### Note:

The variable `refVar` is called “a reference to an `int`.”

This function doubles `refVar` by multiplying it by 2. Since `refVar` is a reference variable, this action is actually performed on the variable that was passed to the function as an argument. When prototyping a function with a reference variable, be sure to include the ampersand after the data type. Here is the prototype for the `doubleNum` function:

```
void doubleNum(int &);
```



## Note:

Some programmers prefer not to put a space between the data type and the ampersand. The following prototype is equivalent to the one above:

```
void doubleNum(int &);
```



## Note:

The ampersand must appear in both the prototype and the header of any function that uses a reference variable as a parameter. It does not appear in the function call.

**Program 6-25**  demonstrates how the `doubleNum` function works.

## Program 6-25

```
1 // This program uses a reference variable as a
function
2 // parameter.
3 #include <iostream>
4 using namespace std;
5
6 // Function prototype. The parameter is a
reference variable.
7 void doubleNum(int &);
8
9 int main()
10 {
11     int value = 4;
12
13     cout << "In main, value is " << value <<
endl;
14     cout << "Now calling doubleNum..." <<
endl;
15     doubleNum(value);
16     cout << "Now back in main. value is " <<
value << endl;
17     return 0;
18 }
```



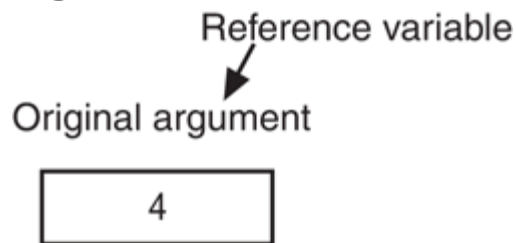
```
19
20
//*****
*****
21 // Definition of doubleNum.
*
22 // The parameter refVar is a reference
variable. The value *
23 // in refVar is doubled.
*
24
//*****
*****
25
26 void doubleNum (int &refVar)
27 {
28     refVar *= 2;
29 }
```

## Program Output

```
In main, value is 4
Now calling doubleNum...
Now back in main. value is 8
```

The parameter `refVar` in [Program 6-25](#) “points” to the `value` variable in function `main`. When a program works with a reference variable, it is actually working with the variable it references, or to which it points. This is illustrated in [Figure 6-15](#).

**Figure 6-15 Reference variable**



Recall that function arguments are normally passed by value, which means a copy of the argument’s value is passed into the parameter variable. When a reference parameter is used, it is said that the argument is *passed by reference*.

[Program 6-26](#) is a modification of [Program 6-25](#). The function `getNum` has been added. The function asks the user to enter a number, which is stored in `userNum`. `userNum` is a reference to `main`’s variable `value`.

## Program 6-26

```
1 // This program uses reference variables as
function parameters.
2 #include <iostream>
3 using namespace std;
4
5 // Function prototypes. Both functions use
reference variables
6 // as parameters.
7 void doubleNum(int &);
8 void getNum(int &);
9
10 int main()
11 {
12     int value;
13
14     // Get a number and store it in value.
15     getNum(value);
16
17     // Double the number stored in value.
18     doubleNum(value);
19
20     // Display the resulting number.
21     cout << "That value doubled is " << value
```

```
<< endl;
22     return 0;
23 }
24
25
//*****
*****
26 // Definition of getNum.
*
27 // The parameter userNum is a reference
variable. The user is *
28 // asked to enter a number, which is stored in
userNum. *
29
//*****
*****
30
31 void getNum(int &userNum)
32 {
33     cout << "Enter a number: ";
34     cin >> userNum;
35 }
36
37
//*****
*****
38 // Definition of doubleNum.
```

```
*
39 // The parameter refVar is a reference
variable. The value *
40 // in refVar is doubled.
*
41
//*****
*****
42
43 void doubleNum (int &refVar)
44 {
45     refVar *= 2;
46 }
```

### Program Output with Example Input Shown in Bold

```
Enter a number: 12 Enter
That value doubled is 24
```



## Note:

Only variables may be passed by reference. If you attempt to pass a nonvariable argument, such as a literal, a constant, or an expression, into a reference parameter, an error will result. Using the `doubleNum` function as an example, the following statements will generate an error:

```
doubleNum(5); // Error
doubleNum(userNum + 10); // Error
```

If a function uses more than one reference variable as a parameter, be sure to place the ampersand before each reference variable name. Here is the prototype and definition for a function that uses four reference variable parameters:

```
// Function prototype with four reference variables
// as parameters.
void addThree(int &, int &, int &, int &);
// Definition of addThree.
// All four parameters are reference variables.
void addThree(int &sum, int &num1, int &num2, int &num3)
{
    cout << "Enter three integer values: ";
    cin >> num1 >> num2 >> num3;
    sum = num1 + num2 + num3;
}
```



## Warning!

Don't get carried away with using reference variables as function parameters. Any time you allow a function to alter a variable that's outside the function, you are creating potential debugging problems. Reference variables should only be used as parameters when the situation requires them.



# Checkpoint

6.19 What kinds of values may be specified as default arguments?

6.20 Write the prototype and header for a function called `compute`. The function should have three parameters: an `int`, a `double`, and a `long` (not necessarily in that order). The `int` parameter should have a default argument of 5, and the `long` parameter should have a default argument of 65536. The `double` parameter should not have a default argument.

6.21 Write the prototype and header for a function called `calculate`. The function should have three parameters: an `int`, a reference to a `double`, and a `long` (not necessarily in that order.) Only the `int` parameter should have a default argument, which is 47.

6.22 What is the output of the following program?



```

#include <iostream>
using namespace std;
void test(int = 2, int = 4, int = 6);
int main()
{
    test();
    test(6);
    test(3, 9);
    test(1, 5, 7);
    return 0;
}
void test (int first, int second, int third)
{
    first += 3;
    second += 6;
    third += 9;
    cout << first << " " << second << " " << third <<
endl;
}

```

6.23 The following program asks the user to enter two numbers. What is the output of the program if the user enters 12 and 14?

```
#include <iostream>

using namespace std;

void func1(int &, int &);

void func2(int &, int &, int &);

void func3(int, int, int);

int main()
{
    int x = 0, y = 0, z = 0;

    cout << x << " " << y << " " << z << endl;

    func1(x, y);

    cout << x << " " << y << " " << z << endl;

    func2(x, y, z);

    cout << x << " " << y << " " << z << endl;

    func3(x, y, z);

    cout << x << " " << y << " " << z << endl;

    return 0;
}

void func1(int &a, int &b)
{
    cout << "Enter two numbers: ";

    cin >> a >> b;
}

void func2(int &a, int &b, int &c)
{
    b++;

    c--;

    a = b + c;
```

```
}  
void func3(int a, int b, int c)  
{  
    a = b - c;  
}
```

## 6.14 Overloading Functions

### Concept:

Two or more functions may have the same name, as long as their parameter lists are different.

Sometimes, you will create two or more functions that perform the same operation, but use a different set of parameters or parameters of different data types. For instance, in [Program 6-13](#) there is a `square` function that uses a `double` parameter. But, suppose you also wanted a `square` function that works exclusively with integers, accepting an `int` as its argument. Both functions would do the same thing: return the square of their argument. The only difference is the data type involved in the operation. If you were to use both these functions in the same program, you could assign a unique name to each function. For example, the function that squares an `int` might be named `squareInt`, and the one that squares a `double` might be named `squareDouble`. C++, however, allows you to *overload* functions. That means you may assign the same name to multiple functions, as long as their parameter lists are different. [Program 6-27](#) uses two overloaded `square` functions.

## Program 6-27

```
1 // This program uses overloaded functions.
2 #include <iostream>
3 #include <iomanip>
4 using namespace std;
5
6 // Function prototypes
7 int square(int);
8 double square(double);
9
10 int main()
11 {
12     int userInt;
13     double userFloat;
14
15     // Get an int and a double.
16     cout << fixed << showpoint <<
17     setprecision(2);
18     cout << "Enter an integer and a floating-
19     point value: ";
20     cin >> userInt >> userFloat;
21
22     // Display their squares.
23     cout << "Here are their squares: ";
```

```
22     cout << square(userInt) << " and " <<
square(userFloat);
23     return 0;
24 }
25
26
27 //*****
28 // Definition of overloaded function square.
29 // This function uses an int parameter,
30 // number. It returns the *
31 // square of number as an int.
32 //*****
33
34 int square(int number)
35 {
36     return number * number;
37 }
38 //*****
39 // Definition of overloaded function square.
```

```

*
39 // This function uses a double parameter,
number. It returns *
40 // the square of number as a double.
*
41
//*****
*****
42
43 double square(double number)
44 {
45     return number * number;
46 }


```

### Program Output with Example Input Shown in Bold

```

Enter an integer and a floating-point value:
12 4.2
Here are their squares: 144 and 17.64

```

Here are the headers for the `square` functions used in [Program 6-27](#) :

```
int square(int number)
double square(double number)
```

In C++, each function has a signature. The *function signature* is the name of the function and the data types of the function's parameters in the proper order. The `square` functions in [Program 6-27](#) would have the following signatures:

```
square(int)
square(double)
```

When an overloaded function is called, C++ uses the function signature to distinguish it from other functions with the same name. In [Program 6-27](#), when an `int` argument is passed to `square`, the version of the function that has an `int` parameter is called. Likewise, when a `double` argument is passed to `square`, the version with a `double` parameter is called.

Note the function's return value is not part of the signature. The following functions could not be used in the same program because their parameter lists aren't different:




```
int square(int number)
{
    return number * number
}

double square(int number) // Wrong! Parameter lists must differ
{
    return number * number
}
```

Overloading is also convenient when there are similar functions that use a different number of parameters. For example, consider a program with functions that return the sum of integers. One returns the sum of two integers, another returns the sum of three integers, and yet another returns the sum of four integers. Here are their function headers:

```
int sum(int num1, int num2)
int sum(int num1, int num2, int num3)
int sum(int num1, int num2, int num3, int num4)
```

Because the number of parameters is different in each, they all may be used in the same program. **Program 6-28**  is an example that uses two functions, each named `calcWeeklyPay`, to determine an employee's gross weekly pay. One version of the function uses an

`int` and a `double` parameter, while the other version only uses a `double` parameter.

## Program 6-28

```
1 // This program demonstrates overloaded
functions to calculate
2 // the gross weekly pay of hourly paid or
salaried employees.
3 #include <iostream>
4 #include <iomanip>
5 using namespace std;
6
7 // Function prototypes
8 void getChoice(char &);
9 double calcWeeklyPay(int, double);
10 double calcWeeklyPay(double);
11
12 int main()
13 {
14     char selection; // Menu selection
15     int worked; // Hours worked
16     double rate; // Hourly pay rate
17     double yearly; // Yearly salary
18
19     // Set numeric output formatting.
20     cout << fixed << showpoint <<
setprecision(2);
```

```
21
22     // Display the menu and get a selection.
23     cout << "Do you want to calculate the
weekly pay of\n";
24     cout << "(H) an hourly paid employee, or
\n";
25     cout << "(S) a salaried employee?\n";
26     getChoice(selection);
27
28     // Process the menu selection.
29     switch (selection)
30     {
31         // Hourly paid employee
32         case 'H' :
33             case 'h' : cout << "How many hours
were worked? ";
34                 cin >> worked;
35                 cout << "What is the hourly
pay rate? ";
36                 cin >> rate;
37                 cout << "The gross weekly
pay is $";
38                 cout <<
calcWeeklyPay(worked, rate) << endl;
39                 break;
40
41         // Salaried employee
```

```

42         case 'S' :
43         case 's' : cout << "What is the
annual salary? ";
44                 cin >> yearly;
45                 cout << "The gross weekly
pay is $";
46                 cout <<
calcWeeklyPay(yearly) << endl;
47                 break;
48     }
49     return 0;
50 }
51
52
//*****
*****
53 // Definition of function getChoice.
*
54 // The parameter letter is a reference to a
char. *
55 // This function asks the user for an H or an
S and returns *
56 // the validated input.
*
57
//*****
*****

```

```

58
59 void getChoice(char & letter)
60 {
61     // Get the user's selection.
62     cout << "Enter your choice (H or S): ";
63     cin >> letter;
64
65     // Validate the selection.
66     while (letter != 'H' && letter != 'h' &&
67            letter != 'S' && letter != 's')
68     {
69         cout << "Please enter H or S: ";
70         cin >> letter;
71     }
72 }
73
74
//*****
*****
75 // Definition of overloaded function
calcWeeklyPay.      *
76 // This function calculates the gross weekly
pay of      *
77 // an hourly paid employee. The parameter
hours holds the *
78 // number of hours worked. The parameter
payRate holds the *

```

```

79 // hourly pay rate. The function returns the
weekly salary.*
80
//*****
*****
81
82 double calcWeeklyPay(int hours, double
payRate)
83 {
84     return hours * payRate;
85 }
86
87
//*****
*****
88 // Definition of overloaded function
calcWeeklyPay.*
89 // This function calculates the gross weekly
pay of *
90 // a salaried employee. The parameter holds
the employee's *
91 // annual salary. The function returns the
weekly salary.*
92
//*****
*****
93

```

```
94 double calcWeeklyPay(double annSalary)
95 {
96     return annSalary / 52;
97 }
```

### Program Output with Example Input Shown in Bold

```
Do you want to calculate the weekly pay of
(H) an hourly paid employee, or
(S) a salaried employee?
Enter your choice (H or S): H Enter
How many hours were worked? 40 Enter
What is the hourly pay rate? 18.50 Enter
The gross weekly pay is $740.00
```

### Program Output with Example Input Shown in Bold



Do you want to calculate the weekly pay of  
(H) an hourly paid employee, or  
(S) a salaried employee?

Enter your choice (H or S): **S** Enter

What is the annual salary? **68000.00** Enter


The gross weekly pay is \$1307.69

## 6.15 The `exit()` Function

### Concept:

The `exit()` function causes a program to terminate, regardless of which function or control mechanism is executing.

A C++ program stops executing when the `return` statement in function `main` is encountered. When other functions end, however, the program does not stop. Control of the program goes back to the place immediately following the function call. Sometimes rare circumstances make it necessary to terminate a program in a function other than `main`. To accomplish this, the `exit` function is used.

When the `exit` function is called, it causes the program to stop, regardless of which function contains the call. [Program 6-29](#)  demonstrates its use.

## Program 6-29

```
1 // This program shows how the exit function
causes a program
2 // to stop executing.
3 #include <iostream>
4 #include <cstdlib> // Needed for the exit
function
5 using namespace std;
6
7 void function(); // Function prototype
8
9 int main()
10 {
11     function();
12     return 0;
13 }
14
15
16 //*****
17 // This function simply demonstrates that exit
can be used *
18 // to terminate a program from a function
other than main. *
```

```
18
//*****
*****
19
20 void function()
21 {
22     cout << "This program terminates with the
exit function.\n";
23     cout << "Bye!\n";
24     exit(0);
25     cout << "This message will never be
displayed\n";
26     cout << "because the program has already
terminated.\n";
27 }
```

## Program Output

```
This program terminates with the exit
function.
Bye!
```

To use the `exit` function, you must include the `<cstdlib>` header file. Notice the function takes an integer argument. This argument is

the exit code you wish the program to pass back to the computer's operating system. This code is sometimes used outside of the program to indicate whether the program ended successfully or as the result of a failure. In [Program 6-29](#), the exit code zero is passed, which commonly indicates a successful exit. If you are unsure which code to use with the `exit` function, there are two named constants, `EXIT_FAILURE` and `EXIT_SUCCESS`, defined in `<cstdlib>` for you to use. The constant `EXIT_FAILURE` is defined as the termination code that commonly represents an unsuccessful exit under the current operating system. Here is an example of its use:

```
exit(EXIT_FAILURE);
```

The constant `EXIT_SUCCESS` is defined as the termination code that commonly represents a successful exit under the current operating system. Here is an example:

```
exit(EXIT_SUCCESS);
```



## Note:

Generally, the exit code is important only if you know it will be tested outside the program. If it is not used, just pass zero, or

```
EXIT_SUCCESS.
```



## Warning!

The `exit()` function unconditionally shuts down your program. Because it bypasses a program's normal logical flow, you should use it with caution.



6.24 What is the output of the following program?

```
#include <iostream>
#include <cstdlib>
using namespace std;
void showVals(double, double);
int main()
{
    double x = 1.2, y = 4.5;
    showVals(x, y);
    return 0;
}
void showVals(double p1, double p2)
{
    cout << p1 << endl;
    exit(0);
    cout << p2 << endl;
}
```

6.25 What is the output of the following program?

```
#include <iostream>
using namespace std;
int manip(int);
int manip(int, int);
int manip(int, double);
int main()
{
    int x = 2, y= 4, z;
    double a = 3.1;
    z = manip(x) + manip(x, y) + manip(y, a);
    cout << z << endl;
    return 0;
}
int manip(int val)
{
    return val + val * 2;
}
int manip(int val1, int val2)
{
    return (val1 + val2) * 2;
}
int manip(int val1, double val2)
{
    return val1 * static_cast<int>(val2);
}
```



## 6.16 Stubs and Drivers

*Stubs* and *drivers* are very helpful tools for testing and debugging programs that use functions. They allow you to test the individual functions in a program, in isolation from the parts of the program that call the functions.

A *stub* is a dummy function that is called instead of the actual function it represents. It usually displays a test message acknowledging that it was called, and nothing more. For example, if a stub were used for the `showFees` function in [Program 6-10](#) (the modular health club membership program), it might look like this:

```
void showFees(double memberRate, int months)
{
    cout << "The showFees function was called with "
        << "the following arguments:\n"
        << "memberRate: " << memberRate << endl
        << "months: " << months << endl;
}
```

The following is an example output of the program if it were run with the stub instead of the actual `showFees` function. (A version of the health club program using this stub function is available from


Computer Science Portal at [www.pearsonhighered.com/gaddis](http://www.pearsonhighered.com/gaddis).  
The program is named HealthClubWithStub.cpp.)

```
Health Club Membership Menu
1. Standard Adult Membership
2. Child Membership
3. Senior Citizen Membership
4. Quit the Program
Enter your choice: 1 Enter
For how many months? 4 Enter
The showFees function was called with the following arguments:
memberRate: 40.00
months: 4

Health Club Membership Menu
1. Standard Adult Membership
2. Child Membership
3. Senior Citizen Membership
4. Quit the Program
Enter your choice: 4 Enter
```

As you can see, by replacing an actual function with a stub, you can concentrate your testing efforts on the parts of the program that call the function. Primarily, the stub allows you to determine whether your program is calling a function when you expect it to, and to confirm that valid values are being passed to the function. If the stub represents a function that returns a value, then the stub should

return a test value. This helps you confirm that the return value is being handled properly. When the parts of the program that call a function are debugged to your satisfaction, you can move on to testing and debugging the actual functions themselves. This is where *drivers* become useful.

A driver is a program that tests a function by simply calling it. If the function accepts arguments, the driver passes test data. If the function returns a value, the driver displays the return value on the screen. This allows you to see how the function performs in isolation from the rest of the program it will eventually be part of. **Program 6-30**  shows a driver for testing the `showFees` function in the health club membership program.

## Program 6-30

```
1 // This program is a driver for testing the
showFees function.
2 #include <iostream>
3 using namespace std;
4
5 // Prototype
6 void showFees(double, int);
7
8 int main()
9 {
10     // Constants for membership rates
11     const double ADULT = 40.0;
12     const double SENIOR = 30.0;
13     const double CHILD = 20.0;
14
15     // Perform a test for adult membership.
16     cout << "Testing an adult membership...\n"
17          << "Calling the showFees function
with arguments "
18          << ADULT << " and 10.\n";
19     showFees(ADULT, 10);
20
21     // Perform a test for senior citizen
```

```

membership.
22     cout << "\nTesting a senior citizen
membership...\n"
23     << "Calling the showFees function
with arguments "
24     << SENIOR << " and 10.\n";
25     showFees(SENIOR, 10);
26
27     // Perform a test for child membership.
28     cout << "\nTesting a child
membership...\n"
29     << "Calling the showFees function
with arguments "
30     << CHILD << " and 10.\n";
31     showFees(CHILD, 10);
32     return 0;
33 }
34
35
//*****
*****
36 // Definition of function showFees. The
memberRate parameter holds *
37 // the monthly membership rate and the months
parameter holds the *
38 // number of months. The function displays the
total charges. *
```


```
39
//*****
*****
40
41 void showFees(double memberRate, int months)
42 {
43     cout << "The total charges are $"
44         << (memberRate * months) << endl;
45 }
```

## Program Output

```
Testing an adult membership...
Calling the showFees function with arguments
40 and 10.
The total charges are $400

Testing a senior citizen membership...
Calling the showFees function with arguments
30 and 10.
The total charges are $300

Testing a child membership...
Calling the showFees function with arguments
20 and 10.
The total charges are $200
```

As shown in **Program 6-30** , a driver can be used to thoroughly test a function. It can repeatedly call the function with different test values as arguments. When the function performs as desired, it can be placed into the actual program it will be part of.

Case Study: See High Adventure Travel Agency Part 1 Case Study on the Computer Science Portal at [www.pearsonhighered.com/gaddis](http://www.pearsonhighered.com/gaddis).

# Review Questions and Exercises

## Short Answer

1. Why do local variables lose their values between calls to the function in which they are defined?
2. What is the difference between an argument and a parameter variable?
3. Where do you define parameter variables?
4. If you are writing a function that accepts an argument and you want to make sure the function cannot change the value of the argument, what do you do?
5. When a function accepts multiple arguments, does it matter in what order the arguments are passed?
6. How do you return a value from a function?
7. What is the advantage of breaking your application's code into several small procedures?
8. How would a `static` local variable be useful?
9. Give an example where passing an argument by reference would be useful.



# Fill-in-the-Blank

10. The \_\_\_\_\_ is the part of a function definition that shows the function name, return type, and parameter list.
11. If a function doesn't return a value, the word \_\_\_\_\_ will appear as its return type.
12. Either a function's \_\_\_\_\_ or its \_\_\_\_\_ must precede all calls to the function.
13. Values that are sent into a function are called \_\_\_\_\_.
14. Special variables that hold copies of function arguments are called \_\_\_\_\_.
15. When only a copy of an argument is passed to a function, it is said to be passed by \_\_\_\_\_.
16. A(n) \_\_\_\_\_ eliminates the need to place a function definition before all calls to the function.
17. A(n) \_\_\_\_\_ variable is defined inside a function and is not accessible outside the function.
18. \_\_\_\_\_ variables are defined outside all functions and are accessible to any function within their scope.
19. \_\_\_\_\_ variables provide an easy way to share large amounts of data among all the functions in a program.
20. Unless you explicitly initialize global variables, they are automatically initialized to \_\_\_\_\_.
21. If a function has a local variable with the same name as a global variable, only the \_\_\_\_\_ variable can be seen by the function.

22. \_\_\_\_\_ local variables retain their value between function calls.
23. The \_\_\_\_\_ statement causes a function to end immediately.
24. \_\_\_\_\_ arguments are passed to parameters automatically if no argument is provided in the function call.
25. When a function uses a mixture of parameters with and without default arguments, the parameters with default arguments must be defined \_\_\_\_\_.
26. The value of a default argument must be a(n) \_\_\_\_\_.
27. When used as parameters, \_\_\_\_\_ variables allow a function to access the parameter's original argument.
28. Reference variables are defined like regular variables, except there is a(n) \_\_\_\_\_ in front of the name.
29. Reference variables allow arguments to be passed by \_\_\_\_\_.
30. The \_\_\_\_\_ function causes a program to terminate.
31. Two or more functions may have the same name, as long as their \_\_\_\_\_ are different.

# Algorithm Workbench

32. Examine the following function header, then write an example call to the function:

```
void showValue(int quantity)
```

33. The following statement calls a function named `half`. The `half` function returns a value that is half that of the argument. Write the function.

```
result = half(number);
```

34. A program contains the following function:

```
int cube(int num)
{
    return num * num * num;
}
```

Write a statement that passes the value 4 to this function and assigns its return value to the variable `result`.

35. Write a function named `timesTen` that accepts an argument. When the function is called, it should display the product of its argument multiplied by 10.

36. A program contains the following function:

```
void display(int arg1, double arg2, char arg3)
{
    cout << "Here are the values: "
        << arg1 << " " << arg2 << " "
        << arg3 << endl;
}
```

Write a statement that calls the procedure and passes the following variables to it:

```
int age;
double income;
char initial;
```

37. Write a function named `getNumber` that uses a reference parameter variable to accept an integer argument. The function should prompt the user to enter a number in the range of 1 through 100. The input should be validated and stored in the parameter variable.

# True or False

38. T F Functions should be given names that reflect their purpose.
39. T F Function headers are terminated with a semicolon.
40. T F Function prototypes are terminated with a semicolon.
41. T F If other functions are defined before `main`, the program still starts executing at function `main`.
42. T F When a function terminates, it always branches back to `main`, regardless of where it was called from.
43. T F Arguments are passed to the function parameters in the order they appear in the function call.
44. T F The scope of a parameter is limited to the function that uses it.
45. T F Changes to a function parameter always affect the original argument as well.
46. T F In a function prototype, the names of the parameter variables may be left out.
47. T F Many functions may have local variables with the same name.
48. T F Overuse of global variables can lead to problems.
49. T F Static local variables are not destroyed when a function returns.
50. T F All static local variables are initialized to `-1` by default.
51. T F Initialization of static local variables only happens once, regardless of how many times the function in which they are defined is called.

52. T F When a function with default arguments is called and an argument is left out, all arguments that come after it must be left out as well.
53. T F It is not possible for a function to have some parameters with default arguments and some without.
54. T F The `exit` function can only be called from `main`.
55. T F A stub is a dummy function that is called instead of the actual function it represents.

# Find the Errors

Each of the following functions has errors. Locate as many errors as you can.

56. 

```
void total(int value1, value2, value3)
{
    return value1 + value2 + value3;
}
```

57. 

```
double average(int value1, int value2, int value3)
{
    double average;
    average = value1 + value2 + value3 / 3;
}
```

58. 

```
void area(int length = 30, int width)
{
    return length * width;
}
```

59.

```
void getValue(int value&)  
{  
    cout << "Enter a value: ";  
    cin >> value&;  
}
```

60. (*Overloaded functions*)

```
int getValue()  
{  
    int inputValue;  
    cout << "Enter an integer: ";  
    cin >> inputValue;  
    return inputValue;  
}  
  
double getValue()  
{  
    double inputValue;  
    cout << "Enter a floating-point number: ";  
    cin >> inputValue;  
    return inputValue;  
}
```



# Programming Challenges



## Solving the Markup Problem

### 1. Markup

Write a program that asks the user to enter an item's wholesale cost and its markup percentage. It should then display the item's retail price. For example:

- If an item's wholesale cost is 5.00 and its markup percentage is 100 percent, then the item's retail price is 10.00.
- If an item's wholesale cost is 5.00 and its markup percentage is 50 percent, then the item's retail price is 7.50.

The program should have a function named `calculateRetail` that receives the wholesale cost and the markup percentage as arguments and returns the retail price of the item.

Input Validation: Do not accept negative values for either the wholesale cost of the item or the markup percentage.

## 2. Rectangle Area—Complete the Program

If you have downloaded this book's source code, you will find a partially written program named `AreaRectangle.cpp` in the **Chapter 06** folder. Your job is to complete the program.

When it is complete, the program will ask the user to enter the width and length of a rectangle, then display the rectangle's area. The program calls the following functions, which have not been written:

- `getLength`—This function should ask the user to enter the rectangle's length then return that value as a `double`.
- `getWidth`—This function should ask the user to enter the rectangle's width then return that value as a `double`.
- `getArea`—This function should accept the rectangle's length and width as arguments and return the rectangle's area. The area is calculated by multiplying the length by the width.
- `displayData`—This function should accept the rectangle's length, width, and area as arguments and display them in an appropriate message on the screen.

## 3. Winning Division

Write a program that determines which of a company's four divisions (Northeast, Southeast, Northwest, and Southwest) had the greatest sales for a quarter. It should include the following two functions, which are called by `main`:

- `double getSales()` is passed the name of a division. It asks the user for a division's quarterly sales figure, validates the input, then returns it. It should be called once for each division.
- `void findHighest()` is passed the four sales totals. It determines which is the largest and prints the name of the high-grossing division, along with its sales figure.

Input Validation: Do not accept dollar amounts less than \$0.00.

#### 4. Safest Driving Area

Write a program that determines which of five geographic regions within a major city (north, south, east, west, and central) had the fewest reported automobile accidents last year. It should have the following two functions, which are called by `main`:

- `int getNumAccidents()` is passed the name of a region. It asks the user for the number of automobile accidents reported in that region during the last year, validates the input, then returns it. It should be called once for each city region.
- `void findLowest()` is passed the five accident totals. It determines which is the smallest and prints the name of the region, along with its accident figure.

Input Validation: Do not accept an accident number that is less than 0.

#### 5. Falling Distance

When an object is falling because of gravity, the following formula can be used to determine the distance the object falls in a specific time period:

$$d = \frac{1}{2}gt^2$$

The variables in the formula are as follows:  $d$  is the distance in meters,  $g$  is 9.8, and  $t$  is the amount of time, in seconds, that the object has been falling.

Write a function named `fallingDistance` that accepts an object's falling time (in seconds) as an argument. The function should return the distance, in meters, that the object has fallen during that time interval. Write a program that demonstrates the function by calling it in a loop that passes the values 1 through 10 as arguments and displays the return value.

## 6. Kinetic Energy

In physics, an object that is in motion is said to have kinetic energy. The following formula can be used to determine a moving object's kinetic energy:

$$KE = \frac{1}{2}mv^2$$

The variables in the formula are as follows:  $KE$  is the kinetic energy,  $m$  is the object's mass in kilograms, and  $v$  is the object's velocity, in meters per second.

Write a function named `kineticEnergy` that accepts an object's mass (in kilograms) and velocity (in meters per second) as arguments. The function should return the amount

of kinetic energy that the object has. Demonstrate the function by calling it in a program that asks the user to enter values for mass and velocity.

## 7. Celsius Temperature Table

The formula for converting a temperature from Fahrenheit to Celsius is

$$C = \frac{5}{9}(F - 32)$$

where  $F$  is the Fahrenheit temperature and  $C$  is the Celsius temperature. Write a function named `celsius` that accepts a Fahrenheit temperature as an argument. The function should return the temperature, converted to Celsius. Demonstrate the function by calling it in a loop that displays a table of the Fahrenheit temperatures 0 through 20 and their Celsius equivalents.

## 8. Coin Toss

Write a function named `coinToss` that simulates the tossing of a coin. When you call the function, it should generate a random number in the range of 1 through 2. If the random number is 1, the function should display “heads.” If the random number is 2, the function should display “tails.” Demonstrate the function in a program that asks the user how many times the coin should be tossed, then simulates the tossing of the coin that number of times.

## 9. Present Value

Suppose you want to deposit a certain amount of money into a savings account and then leave it alone to draw interest for the

next 10 years. At the end of 10 years, you would like to have \$10,000 in the account. How much do you need to deposit today to make that happen? You can use the following formula, which is known as the present value formula, to find out:

$$P = \frac{F}{(1 + r)^n}$$

The terms in the formula are as follows:

- $P$  is the **present value**, or the amount that you need to deposit today.
- $F$  is the **future value** that you want in the account. (In this case,  $F$  is \$10,000.)
- $r$  is the **annual interest rate**.
- $n$  is the **number of years** that you plan to let the money sit in the account.

Write a program that has a function named `presentValue` that performs this calculation. The function should accept the future value, annual interest rate, and number of years as arguments. It should return the present value, which is the amount that you need to deposit today. Demonstrate the function in a program that lets the user experiment with different values for the formula's terms.

## 10. Future Value

Suppose you have a certain amount of money in a savings account that earns compound monthly interest, and you want to calculate the amount that you will have after a specific

number of months. The formula, which is known as the future value formula, is

$$F = P \times (1 + i)^t$$

The terms in the formula are as follows:

- $F$  is the **future value** of the account after the specified time period.
- $P$  is the **present value** of the account.
- $i$  is the **monthly interest rate**.
- $t$  is the **number of months**.

Write a program that prompts the user to enter the account's present value, monthly interest rate, and the number of months that the money will be left in the account. The program should pass these values to a function named `futureValue` that returns the future value of the account, after the specified number of months. The program should display the account's future value.

#### 11. **Lowest Score Drop**

Write a program that calculates the average of a group of test scores, where the lowest score in the group is dropped. It should use the following functions:

- `void getScore()` should ask the user for a test score, store it in a reference parameter variable, and validate it. This function should be called by `main` once for each of the five scores to be entered.

- `void calcAverage()` should calculate and display the average of the four highest scores. This function should be called just once by `main` and should be passed the five scores.
- `int findLowest()` should find and return the lowest of the five scores passed to it. It should be called by `calcAverage`, which uses the function to determine which of the five scores to drop.

Input Validation: Do not accept test scores lower than 0 or higher than 100.

## 12. Star Search

A particular talent competition has five judges, each of whom awards a score between 0 and 10 to each performer.

Fractional scores, such as 8.3, are allowed. A performer's final score is determined by dropping the highest and lowest score received, then averaging the three remaining scores. Write a program that uses this method to calculate a contestant's score. It should include the following functions:

- `void getJudgeData()` should ask the user for a judge's score, store it in a reference parameter variable, and validate it. This function should be called by `main` once for each of the five judges.
- `void calcScore()` should calculate and display the average of the three scores that remain after dropping the highest and lowest scores the performer received. This function should be called just once by `main` and should be passed the five scores.



The last two functions, described below, should be called by `calcScore`, which uses the returned information to determine which of the scores to drop.

- `int findLowest()` should find and return the lowest of the five scores passed to it.
- `int findHighest()` should find and return the highest of the five scores passed to it.

Input Validation: Do not accept judge scores lower than 0 or higher than 10.

### 13. Days Out

Write a program that calculates the average number of days a company's employees are absent. The program should have the following functions:

- A function called by `main` that asks the user for the number of employees in the company. This value should be returned as an `int`. (The function accepts no arguments.)
- A function called by `main` that accepts one argument: the number of employees in the company. The function should ask the user to enter the number of days each employee missed during the past year. The total of these days should be returned as an `int`.
- A function called by `main` that takes two arguments: the number of employees in the company and the total number of days absent for all employees during the year. The function should return, as a `double`, the average number of days absent. (This function does not perform screen output and does not ask the user for input.)

Input Validation: Do not accept a number less than 1 for the number of employees. Do not accept a negative number for the days any employee missed.

#### 14. **Order Status**

The Middletown Wholesale Copper Wire Company sells spools of copper wiring for \$100 each. Write a program that displays the status of an order. The program should have a function that asks for the following data:

- The number of spools ordered
- The number of spools in stock
- Whether there are special shipping and handling charges

(Shipping and handling is normally \$10 per spool.) If there are special charges, the program should ask for the special charges per spool.

The gathered data should be passed as arguments to another function that displays:

- The number of spools ready to ship from current stock
- The number of spools on backorder (if the number ordered is greater than what is in stock)
- Subtotal of the portion ready to ship (the number of spools ready to ship times \$100)
- Total shipping and handling charges on the portion ready to ship
- Total of the order ready to ship

The shipping and handling parameter in the second function should have the default argument 10.00.

Input Validation: Do not accept numbers less than 1 for spools ordered. Do not accept a number less than 0 for spools in stock or shipping and handling charges.

### 15. **Overloaded Hospital**

Write a program that computes and displays the charges for a patient's hospital stay. First, the program should ask if the patient was admitted as an inpatient or an outpatient. If the patient was an inpatient, the following data should be entered:

- The number of days spent in the hospital
- The daily rate
- Hospital medication charges
- Charges for hospital services (lab tests, etc.)

The program should ask for the following data if the patient was an outpatient:

- Charges for hospital services (lab tests, etc.)
- Hospital medication charges

The program should use two overloaded functions to calculate the total charges. One of the functions should accept arguments for the inpatient data, while the other function accepts arguments for outpatient information. Both functions should return the total charges.

Input Validation: Do not accept negative numbers for any data.

### 16. **Population**

In a population, the birth rate is the percentage increase of the population due to births, and the death rate is the percentage decrease of the population due to deaths. Write a program that

displays the size of a population for any number of years. The program should ask for the following data:

- The starting size of a population
- The annual birth rate
- The annual death rate
- The number of years to display

Write a function that calculates the size of the population for a year. The formula is

$$N = P + BP - DP$$

where  $N$  is the new population size,  $P$  is the previous population size,  $B$  is the birth rate, and  $D$  is the death rate.

Input Validation: Do not accept numbers less than 2 for the starting size. Do not accept negative numbers for birth rate or death rate. Do not accept numbers less than 1 for the number of years.

## 17. Transient Population

Modify Programming Challenge 16 to also consider the effect on population caused by people moving into or out of a geographic area. Given as input a starting population size, the annual birth rate, the annual death rate, the number of individuals who typically move into the area each year, and the number of individuals who typically leave the area each year, the program should project what the population will be `numYears` from now. You can either prompt the user to input a value for `numYear`s, or you can set it within the program.

Input Validation: Do not accept numbers less than 2 for the starting size. Do not accept negative numbers for birth rate, death rate, arrivals, or departures.

### 18. **Paint Job Estimator**

A painting company has determined that for every 110 square feet of wall space, 1 gallon of paint and 8 hours of labor will be required. The company charges \$25.00 per hour for labor.

Write a modular program that allows the user to enter the number of rooms that are to be painted and the price of the paint per gallon. It should also ask for the square feet of wall space in each room. It should then display the following data:

- The number of gallons of paint required
- The hours of labor required
- The cost of the paint
- The labor charges
- The total cost of the paint job

Input validation: Do not accept a value less than 1 for the number of rooms. Do not accept a value less than \$10.00 for the price of paint. Do not accept a negative value for square footage of wall space.

### 19. **Using Files—Hospital Report**

Modify Programming Challenge 15 (Overloaded Hospital) to write the report it creates to a file.

### 20. **Stock Profit**

The profit from the sale of a stock can be calculated as follows:

$$\text{Profit} = ((NS \times SP) - SC) - ((NS \times PP) + PC)$$

where  $NS$  is the number of shares,  $SP$  is the sale price per share,  $SC$  is the sale commission paid,  $PP$  is the purchase price per share, and  $PC$  is the purchase commission paid. If the calculation yields a positive value, then the sale of the stock resulted in a profit. If the calculation yields a negative number, then the sale resulted in a loss.

Write a function that accepts as arguments the number of shares, the purchase price per share, the purchase commission paid, the sale price per share, and the sale commission paid. The function should return the profit (or loss) from the sale of stock.

Demonstrate the function in a program that asks the user to enter the necessary data and displays the amount of the profit or loss.

## 21. **Multiple Stock Sales**

Use the function that you wrote for Programming Challenge 20 (Stock Profit) in a program that calculates the total profit or loss from the sale of multiple stocks. The program should ask the user for the number of stock sales and the necessary data for each stock sale. It should accumulate the profit or loss for each stock sale, then display the total.

## 22. `isPrime` Function

A prime number is a number that is only evenly divisible by itself and 1. For example, the number 5 is prime because it can only be evenly divided by 1 and 5. The number 6, however, is not prime because it can be divided evenly by 1, 2, 3, and 6. Write a function name `isPrime`, which takes an integer as an argument and returns `true` if the argument is a prime number,

or `false` otherwise. Demonstrate the function in a complete program.

 **Tip:**

Recall that the `%` operator divides one number by another, and returns the remainder of the division. In an expression such as `num1 % num2`, the `%` operator will return 0 if `num1` is evenly divisible by `num2`.

### 23. Prime Number List

Use the `isPrime` function that you wrote in Programming Challenge 22 (`isPrime function`) in a program that stores a list of all the prime numbers from 1 through 100 in a file.

### 24. Rock, Paper, Scissors Game

Write a program that lets the user play the game of Rock, Paper, Scissors against the computer. The program should work as follows:

1. When the program begins, a random number in the range of 1 through 3 is generated. If the number is 1, then the computer has chosen rock. If the number is 2, then the computer has chosen paper. If the number is 3, then the computer has chosen scissors. (Don't display the computer's choice yet.)
2. The user enters his or her choice of "rock", "paper", or "scissors" at the keyboard. (You can use a menu if you prefer.)
3. The computer's choice is displayed.

4. A winner is selected according to the following rules:
- If one player chooses rock and the other player chooses scissors, then rock wins. (The rock smashes the scissors.)
  - If one player chooses scissors and the other player chooses paper, then scissors wins. (Scissors cuts paper.)
  - If one player chooses paper and the other player chooses rock, then paper wins. (Paper wraps rock.)
  - If both players make the same choice, the game must be played again to determine the winner.

Be sure to divide the program into functions that perform each major task.



# Group Project

## 25. Travel Expenses

This program should be designed and written by a team of students. Here are some suggestions:

- One student should design function `main`, which will call the other functions in the program. The remainder of the functions will be designed by other members of the team.
- The requirements of the program should be analyzed so each student is given about the same workload.
- The parameters and return types of each function should be decided in advance.
- Stubs and drivers should be used to test and debug the program.
- The program can be implemented as a multi-file program, or all the functions can be cut and pasted into the main file.

Here is the assignment: Write a program that calculates and displays the total travel expenses of a businessperson on a trip. The program should have functions that ask for and return the following:

- The total number of days spent on the trip
- The time of departure on the first day of the trip, and the time of arrival back home on the last day of the trip
- The amount of any round-trip airfare

- The amount of any car rentals
- Miles driven, if a private vehicle was used. Calculate the vehicle expense as \$0.27 per mile driven
- Parking fees (The company allows up to \$6 per day. Anything in excess of this must be paid by the employee.)
- Taxi fees, if a taxi was used anytime during the trip (The company allows up to \$10 per day, for each day a taxi was used. Anything in excess of this must be paid by the employee.)
- Conference or seminar registration fees
- Hotel expenses (The company allows up to \$90 per night for lodging. Anything in excess of this must be paid by the employee.)
- The amount of *each* meal eaten. On the first day of the trip, breakfast is allowed as an expense if the time of departure is before 7 a.m. Lunch is allowed if the time of departure is before 12 noon. Dinner is allowed on the first day if the time of departure is before 6 p.m. On the last day of the trip, breakfast is allowed if the time of arrival is after 8 a.m. Lunch is allowed if the time of arrival is after 1 p.m. Dinner is allowed on the last day if the time of arrival is after 7 p.m. The program should only ask for the amounts of allowable meals. (The company allows up to \$9 for breakfast, \$12 for lunch, and \$16 for dinner. Anything in excess of this must be paid by the employee.)

The program should calculate and display the total expenses incurred by the businessperson, the total allowable expenses

for the trip, the excess that must be reimbursed by the businessperson, if any, and the amount saved by the businessperson if the expenses were under the total allowed.

Input Validation: Do not accept negative numbers for any dollar amount or for miles driven in a private vehicle. Do not accept numbers less than 1 for the number of days. Only accept valid times for the time of departure and the time of arrival.

---

# Chapter 7 Arrays and Vectors

---

## Topics

7.1 Arrays Hold Multiple Values [📄](#)

7.2 Accessing Array Elements [📄](#)

7.3 No Bounds Checking in C++ [📄](#)

7.4 The Range-Based `for` Loop [📄](#)

7.5 Processing Array Contents [📄](#)

7.6 Focus on Software Engineering: Using Parallel Arrays [📄](#)

7.7 Arrays as Function Arguments [📄](#)

7.8 Two-Dimensional Arrays [📄](#)

7.9 Arrays with Three or More Dimensions [📄](#)

7.10 Focus on Problem Solving and Program Design: A Case Study [📄](#)

7.11 Introduction to the STL `vector` [📄](#)

## 7.1 Arrays Hold Multiple Values

### Concept:

An array allows you to store and work with multiple values of the same data type.

The variables you have worked with so far are designed to hold only one value at a time. Each of the variable definitions in [Figure 7-1](#) causes only enough memory to be reserved to hold one value of the specified data type.

**Figure 7-1 Variables can hold one value at a time**

`int count;` Enough memory for 1 int

12314

`float price;` Enough memory for 1 float

56.981

`char letter;` Enough memory for 1 char

A

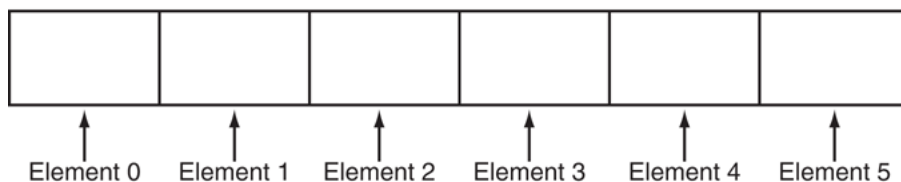
An array works like a variable that can store a group of values, all of the same type. The values are stored together in consecutive memory locations. Here is a definition of an array of integers:

```
int days[6];
```

The name of this array is `days`. The number inside the brackets is the array's *size declarator*. It indicates the number of *elements*, or values, the array can hold. The `days` array can store six elements, each one an integer. This is depicted in [Figure 7-2](#).

**Figure 7-2 An array with six elements**

days array: Enough memory for six int values



An array's size declarator must be a constant integer expression with a value greater than zero. It can be either a literal, as in the previous example, or a named constant, as shown in the following:

```
const int NUM_DAYS = 6;
int days[NUM_DAYS];
```

Arrays of any data type can be defined. The following are all valid array definitions:

```
float temperatures[100]; // Array of 100 floats
string names[10]; // Array of 10 string objects
long units[50]; // Array of 50 long integers
double sizes[1200]; // Array of 1200 doubles
```

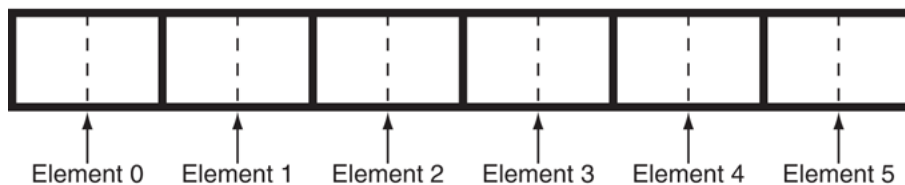
## Memory Requirements of Arrays

The amount of memory used by an array depends on the array's data type and the number of elements. The `hours` array, defined here, is an array of six `short`s.

```
short hours[6];
```

On a typical system, a `short` uses 2 bytes of memory, so the `hours` array would occupy 12 bytes. This is shown in [Figure 7-3](#).

**Figure 7-3 Array memory usage**  
hours array: Each element uses 2 bytes



The size of an array can be calculated by multiplying the size of an individual element by the number of elements in the array. [Table 7-1](#) shows the typical sizes of various arrays.

**Table 7-1 Arrays and Their sizes**

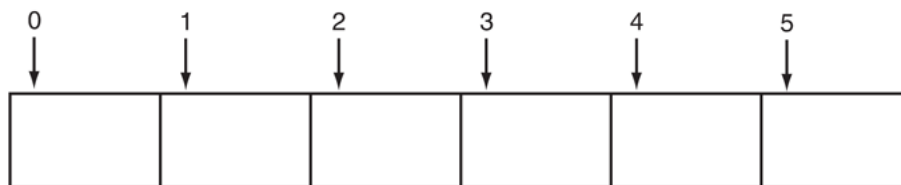
## 7.2 Accessing Array Elements

### Concept:

The individual elements of an array are assigned unique subscripts. These subscripts are used to access the elements.

Even though an entire array has only one name, the elements may be accessed and used as individual variables. This is possible because each element is assigned a number known as a *subscript*. A subscript is used as an index to pinpoint a specific element within an array. The first element is assigned the subscript 0, the second element is assigned 1, and so forth. The six elements in the array `hours` would have the subscripts 0 through 5. This is shown in [Figure 7-4](#).

**Figure 7-4 Subscripts**  
Subscripts



### Note:

Subscript numbering in C++ always starts at zero. The subscript of the last element in an array is one less than the total number of elements in the array. This means that in the array shown in [Figure 7-4](#), the element `hours[6]` does not exist. `hours[5]` is the last element in the array.

Each element in the `hours` array, when accessed by its subscript, can be used as a `short` variable. Here is an example of a statement that stores the number 20 in the first element of the array:

```
hours[0] = 20;
```

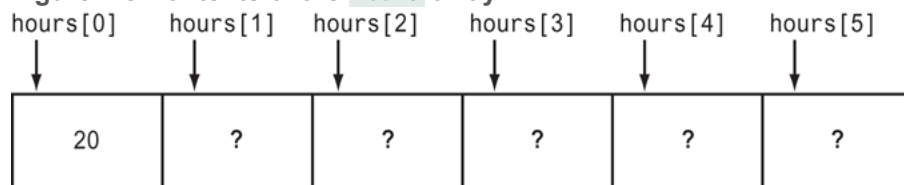


### Note:

The expression `hours[0]` is pronounced “hours sub zero.” You would read this assignment statement as “hours sub zero is assigned twenty.”

Figure 7-5 shows the contents of the `hours` array after the statement assigns 20 to `hours[0]`.

Figure 7-5 Contents of the `hours` array



### Note:

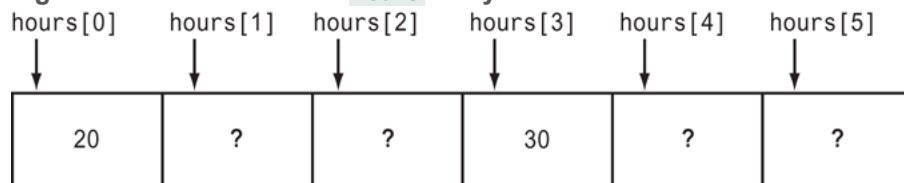
Because values have not been assigned to the other elements of the array, question marks will be used to indicate that the contents of those elements are unknown. If an array is defined globally, all of its elements are initialized to zero by default. Local arrays, however, have no default initialization value.

The following statement stores the integer 30 in `hours[3]`:

```
hours[3] = 30;
```

Figure 7-6 shows the contents of the array after the previous statement executes.

Figure 7-6 Contents of the `hours` array





**Note:**

Understand the difference between the array size declarator and a subscript. The number inside the brackets of an array definition is the size declarator. The number inside the brackets of an assignment statement or any statement that works with the contents of an array is a subscript.

# Inputting and Outputting Array Contents

Array elements may be used with the `cin` and `cout` objects like any other variable. [Program 7-1](#)  shows the array `hours` being used to store and display values entered by the user.

## Program 7-1

```
1 // This program asks for the number of hours worked
2 // by six employees. It stores the values in an array.
3 #include <iostream>
4 using namespace std;
5
6 int main()
7 {
8     const int NUM_EMPLOYEES = 6;
9     int hours[NUM_EMPLOYEES];
10
11     // Get the hours worked by each employee.
12     cout << "Enter the hours worked by "
13         << NUM_EMPLOYEES << " employees: ";
14     cin >> hours[0];
15     cin >> hours[1];
16     cin >> hours[2];
17     cin >> hours[3];
18     cin >> hours[4];
19     cin >> hours[5];
20
21     // Display the values in the array.
22     cout << "The hours you entered are:";
23     cout << " " << hours[0];
24     cout << " " << hours[1];
25     cout << " " << hours[2];
26     cout << " " << hours[3];
27     cout << " " << hours[4];
28     cout << " " << hours[5] << endl;
29     return 0;
30 }
```

**Program Output with Example Input Shown in Bold**

```
Enter the hours worked by 6 employees: 20 12 40 30 30 15 Enter
The hours you entered are: 20 12 40 30 30 15
```


Figure 7-7  shows the contents of the array `hours` with the values entered by the user in the example output above.

Figure 7-7 Contents of the `hours` array



Even though the size declarator of an array definition must be a constant or a literal, subscript numbers can be stored in variables. This makes it possible to use a loop to “step through” an entire array, performing the same operation on each element. For example, look at the following code:

```
const int ARRAY_SIZE = 5;
int numbers[ARRAY_SIZE];

for (int count = 0; count < ARRAY_SIZE; count++)
    numbers[count] = 99;
```



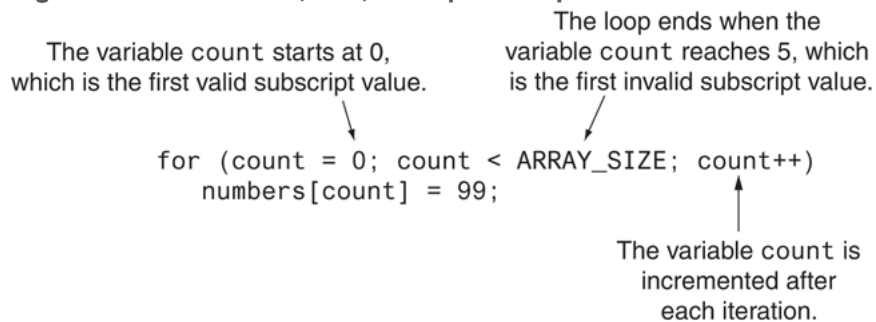
### Accessing Array Elements with a Loop

This code first defines a constant `int` named `ARRAY_SIZE` and initializes it with the value 5. Then, it defines an `int` array named `numbers`, using `ARRAY_SIZE` as the size declarator. As a result, the `numbers` array will have five elements. The `for` loop uses a counter variable named `count`. This loop will iterate five times, and during the loop iterations the `count` variable will take on the values 0 through 4.

Notice the statement inside the loop uses the `count` variable as a subscript. It assigns 99 to `numbers[count]`. During the first iteration, 99 is assigned to `numbers[0]`. During the next iteration, 99 is assigned to `numbers[1]`. This continues until 99 has been assigned to all of the array's elements.

**Figure 7-8** illustrates that the loop's initialization, test, and update expressions have been written so that the loop starts and ends the counter variable with valid subscript values (0 through 4). This ensures that only valid subscripts are used in the body of the loop.

**Figure 7-8 Initialization, test, and update expressions**



**Program 7-1** could be simplified by using two `for` loops: one for inputting the values into the array, and another for displaying the contents of the array. This is shown in **Program 7-2**.

## Program 7-2

```
1 // This program asks for the number of hours worked
2 // by six employees. It stores the values in an array.
3 #include <iostream>
4 using namespace std;
5
6 int main()
7 {
8     const int NUM_EMPLOYEES = 6; // Number of employees
9     int hours[NUM_EMPLOYEES];    // Each employee's hours
10    int count;                    // Loop counter
11
12    // Input the hours worked.
13    for (count = 0; count < NUM_EMPLOYEES; count++)
14    {
15        cout << "Enter the hours worked by employee "
16             << (count + 1) << ": ";
17        cin >> hours[count];
18    }
19
20    // Display the contents of the array.
21    cout << "The hours you entered are:";
22    for (count = 0; count < NUM_EMPLOYEES; count++)
23        cout << " " << hours[count];
24    cout << endl;
25    return 0;
26 }
```

**Program Output with Example Input Shown in Bold**

```
Enter the hours worked by employee 1: 20 Enter
Enter the hours worked by employee 2: 12 Enter
Enter the hours worked by employee 3: 40 Enter
Enter the hours worked by employee 4: 30 Enter
Enter the hours worked by employee 5: 30 Enter
Enter the hours worked by employee 6: 15 Enter
The hours you entered are: 20 12 40 30 30 15
```

The first `for` loop, in lines 13 through 18, prompts the user for each employee's hours. Take a closer look at lines 15 through 17:

```
cout << "Enter the hours worked by employee "
      << (count + 1) << ": ";
cin >> hours[count];
```

Notice the `cout` statement uses the expression `count + 1` to display the employee number, but the `cin` statement uses `count` as the array subscript. This is because the hours for employee number 1 are stored in `hours[0]`, the hours for employee number 2 are stored in `hours[1]`, and so forth.

The loop in lines 22 and 23 also uses the `count` variable to step through the array, displaying each element.



### Note:

You can use any integer expression as an array subscript. For example, the first loop in [Program 7-2](#) could have been written like this:

```
for (count = 1; count <= NUM_EMPLOYEES; count++)
{
    cout << "Enter the hours worked by employee "
        << count << ": ";
    cin >> hours[count - 1];
}
```

In this code, the `cin` statement uses the expression `count - 1` as a subscript.

Inputting data into an array must normally be done one element at a time. For example, the following `cin` statement will not input data into the `hours` array:

```
cin >> hours; // Wrong! This will NOT work.
```

Instead, you must use multiple `cin` statements to read data into each array element, or use a loop to step through the array, reading data into its elements. Also, outputting an array's contents must normally be done one element at a time. For example, the following `cout` statement will not display the contents of the `hours` array:

```
cout << hours; // Wrong! This will NOT work.
```

Instead, you must output each element of the array separately.



# Array Initialization

Like regular variables, C++ allows you to initialize an array's elements when you create the array. Here is an example:

```
const int MONTHS = 12;  
int days[MONTHS] = {31, 28, 31, 30, 31, 30, 31, 31, 30, 31, 30, 31};
```

The series of values inside the braces and separated with commas is called an *initialization list*. These values are stored in the array elements in the order they appear in the list. (The first value, 31, is stored in `days[0]`, the second value, 28, is stored in `days[1]`, and so forth.) [Figure 7-9](#) shows the contents of the array after the initialization.

**Figure 7-9 The array after initialization**

Subscripts											
0	1	2	3	4	5	6	7	8	9	10	11
31	28	31	30	31	30	31	31	30	31	30	31

[Program 7-3](#) demonstrates how an array may be initialized.

## Program 7-3

```
1 // This program displays the number of days in each month.
2 #include <iostream>
3 using namespace std;
4
5 int main()
6 {
7     const int MONTHS = 12;
8     int days[MONTHS] = { 31, 28, 31, 30,
9                          31, 30, 31, 31,
10                         30, 31, 30, 31 };
11
12     for (int count = 0; count < MONTHS; count++)
13     {
14         cout << "Month " << (count + 1) << " has ";
15         cout << days[count] << " days.\n";
16     }
17     return 0;
18 }
```

## Program Output

```
Month 1 has 31 days.  
Month 2 has 28 days.  
Month 3 has 31 days.  
Month 4 has 30 days.  
Month 5 has 31 days.  
Month 6 has 30 days.  
Month 7 has 31 days.  
Month 8 has 31 days.  
Month 9 has 30 days.  
Month 10 has 31 days.  
Month 11 has 30 days.  
Month 12 has 31 days.
```



**Note:**

C++ allows you to spread the initialization list across multiple lines. Both of the following array definitions are equivalent:

```
double coins[5] = {0.05, 0.1, 0.25, 0.5, 1.0};  
double coins[5] = {0.05,  
                   0.1,  
                   0.25,  
                   0.5,  
                   1.0};
```


**Program 7-4** shows an example with a `string` array that is initialized with strings.

## Program 7-4

```
1 // This program initializes a string array.
2 #include<iostream>
3 #include<string>
4 using namespace std;
5
6 int main()
7 {
8     const int SIZE = 9;
9     string planets[SIZE] = { "Mercury", "Venus", "Earth", "Mars",
10                             "Jupiter", "Saturn", "Uranus",
11                             "Neptune", "Pluto (a dwarf planet)" };
12
13     cout << "Here are the planets:\n";
14
15     for (int count = 0; count < SIZE; count++)
16         cout << planets[count] << endl;
17     return 0;
18 }
```

## Program Output

```
Here are the planets:
Mercury
Venus
Earth
Mars
Jupiter
Saturn
Uranus
Neptune
Pluto (a dwarf planet)
```

**Program 7-5**  shows a character array being initialized with the first ten letters of the alphabet. The array is then used to display those characters' ASCII codes.

## Program 7-5

```
1 // This program uses an array of ten characters to store the
2 // first ten letters of the alphabet. The ASCII codes of the
3 // characters are displayed.
4 #include <iostream>
5 using namespace std;
6
7 int main()
8 {
9     const int NUM_LETTERS = 10;
10    char letters[NUM_LETTERS] = {'A', 'B', 'C', 'D', 'E',
11                                'F', 'G', 'H', 'I', 'J'};
12
13    cout << "Character" << "\t" << "ASCII Code\n";
14    cout << "-----" << "\t" << "-----\n";
15    for (int count = 0; count < NUM_LETTERS; count++)
16    {
17        cout << letters[count] << "\t\t";
18        cout << static_cast<int>(letters[count]) << endl;
19    }
20    return 0;
21 }
```

## Program Output

Character	ASCII Code
A	65
B	66
C	67
D	68
E	69
F	70
G	71
H	72
I	73
J	74



**Note:**

An array's initialization list cannot have more values than the array has elements.

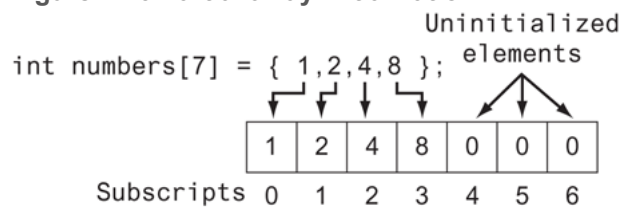
# Partial Array Initialization

When an array is being initialized, C++ does not require a value for every element. It's possible to only initialize part of an array, such as:

```
int numbers[7] = {1, 2, 4, 8};
```

This definition initializes only the first four elements of a 7-element array, as illustrated in [Figure 7-10](#).

**Figure 7-10 Partial array initialization**



It's important to note that if an array is partially initialized, the uninitialized elements will be set to zero. The uninitialized elements of a `string` array will contain empty strings. This is true even if the array is defined locally. (If a local array is completely uninitialized, its elements will contain "garbage," like all other local variables.) [Program 7-6](#) shows the contents of the numbers array after it is partially initialized.



## Program 7-6

```
1 // This program has a partially initialized array.
2 #include <iostream>
3 using namespace std;
4
5 int main()
6 {
7     const int SIZE = 7;
8     int numbers[SIZE] = {1, 2, 4, 8}; // Initialize first 4 elements
9
10    cout << "Here are the contents of the array:\n";
11    for (int index = 0; index < SIZE; index++)
12        cout << numbers[index] << " ";
13
14    cout << endl;
15    return 0;
16 }
```

## Program Output

```
Here are the contents of the array:
1 2 4 8 0 0 0
```

If you leave an element uninitialized, you must leave all the elements that follow it uninitialized as well. C++ does not provide a way to skip elements in the initialization list. For example, the following is *not* legal:

```
int numbers[6] = {2, 4, , 8, , 12}; // NOT Legal!
```

# Implicit Array Sizing

It's possible to define an array without specifying its size, as long as you provide an initialization list. C++ automatically makes the array large enough to hold all the initialization values. For example, the following definition creates an array with five elements:

```
double ratings[] = {1.0, 1.5, 2.0, 2.5, 3.0};
```


Because the size declarator is omitted, C++ counts the number of items in the initialization list and gives the array that many elements.



## **Note:**

You *must* provide an initialization list if you leave out an array's size declarator. Otherwise, the compiler doesn't know how large to make the array.

# Reading Data from a File into an Array

Reading the contents of a file into an array is straightforward: Open the file and use a loop to read each item from the file, storing each item in an array element. The loop should iterate until either the array is filled or the end of the file is reached. [Program 7-7](#)  demonstrates by opening a file that has 10 numbers stored in it then reading the file's contents into an array.

## Program 7-7

```
1 // This program reads data from a file into an array.
2 #include <iostream>
3 #include <fstream>
4 using namespace std;
5
6 int main()
7 {
8     const int ARRAY_SIZE = 10; // Array size
9     int numbers[ARRAY_SIZE]; // Array with 10 elements
10    int count = 0; // Loop counter variable
11    ifstream inputFile; // Input file stream object
12
13    // Open the file.
14    inputFile.open("TenNumbers.txt");
15
16    // Read the numbers from the file into the array.
17    while (count < ARRAY_SIZE && inputFile >> numbers[count])
18        count++;
19
20    // Close the file.
21    inputFile.close();
22
23    // Display the numbers read:
24    cout << "The numbers are: ";
25    for (count = 0; count < ARRAY_SIZE; count++)
26        cout << numbers[count] << " ";
27    cout << endl;
28    return 0;
29 }
```

## Program Output


```
The numbers are: 101 102 103 104 105 106 107 108 109 110
```

The `while` loop in lines 17 and 18 reads items from the file and assigns them to elements of the `numbers` array. Notice the loop tests two Boolean expressions, connected by the `&&` operator:

- The first expression is `count < ARRAY_SIZE`. The purpose of this expression is to prevent the loop from writing beyond the end of the array. If the expression is true, the second Boolean expression is tested. If this expression is false, however, the loop stops.
- The second expression is `inputFile >> numbers[count]`. This expression reads a value from the file and stores it in the `numbers[count]` array element. If a value is successfully read from the file, the expression is true and the loop continues. If no value can be read from the file, however, the expression is false and the loop stops.

Each time the loop iterates, it increments `count` in line 18.

# Writing the Contents of an Array to a File

Writing the contents of an array to a file is also a straightforward matter. Use a loop to step through each element of the array, writing its contents to a file. [Program 7-8](#)  demonstrates this.

## Program 7-8

```
1 // This program writes the contents of an array to a file.
2 #include <iostream>
3 #include <fstream>
4 using namespace std;
5
6 int main()
7 {
8     const int ARRAY_SIZE = 10; // Array size
9     int numbers[ARRAY_SIZE]; // Array with 10 elements
10    int count; // Loop counter variable
11    ofstream outputFile; // Output file stream object
12
13    // Store values in the array.
14    for (count = 0; count < ARRAY_SIZE; count++)
15        numbers[count] = count;
16
17    // Open a file for output.
18    outputFile.open("SavedNumbers.txt");
19
20    // Write the array contents to the file.
21    for (count = 0; count < ARRAY_SIZE; count++)
22        outputFile << numbers[count] << endl;
23
24    // Close the file.
25    outputFile.close();
26
27    // That's it!
28    cout << "The numbers were saved to the file.\n ";
29    return 0;
30 }
```

## Program Output

The numbers were saved to the file.

**Contents of the File** `SavedNumbers.txt`

0  
1  
2  
3  
4  
5  
6  
7  
8  
9




## 7.3 No Bounds Checking in C++

### Concept:


C++ does not prevent you from overwriting an array's bounds.

C++ is a popular language for software developers who have to write fast, efficient code. To increase runtime efficiency, C++ does not provide many of the common safeguards to prevent unsafe memory access found in other languages. For example, C++ does not perform array bounds checking. This means you can write programs with subscripts that go beyond the boundaries of a particular array.

**Program 7-9**  demonstrates this capability.




### Warning!

**Program 7-9**  will attempt to write to an area of memory outside the array. This is an invalid operation and will most likely cause the program to crash.

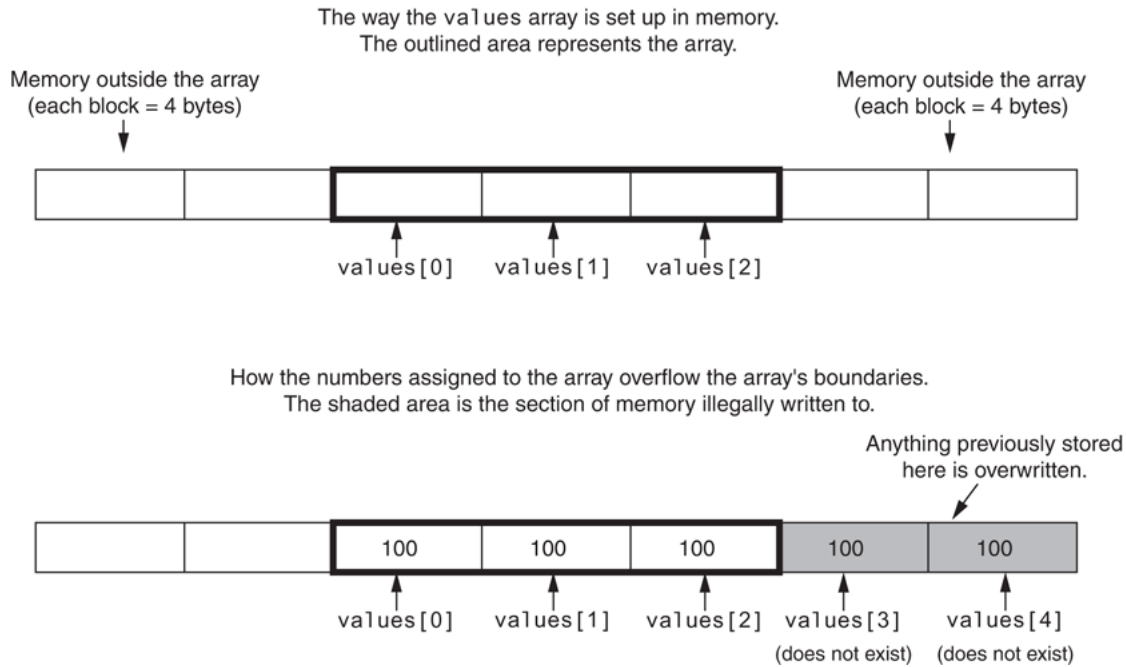
## Program 7-9

```
1 // This program unsafely accesses an area of memory by writing
2 // values beyond an array's boundary.
3 // WARNING: If you compile and run this program, it could crash.
4 #include <iostream>
5 using namespace std;
6
7 int main()
8 {
9     const int SIZE = 3; // Constant for the array size
10    int values[SIZE]; // An array of 3 integers
11    int count; // Loop counter variable
12
13    // Attempt to store five numbers in the 3-element array.
14    cout << "I will store 5 numbers in a 3-element array!\n";
15    for (count = 0; count < 5; count++)
16        values[count] = 100;
17
18    // If the program is still running, display the numbers.
19    cout << "If you see this message, it means the program\n";
20    cout << "has not crashed! Here are the numbers:\n";
21    for (count = 0; count < 5; count++)
22        cout << values[count] << endl;
23    return 0;
24 }
```

The `values` array has three integer elements, with the subscripts 0, 1, and 2. The loop, however, stores the number 100 in elements 0, 1, 2, 3, and 4. The elements with subscripts 3 and 4 do not exist, but C++ allows the program to write beyond the boundary of the array, as if those elements were there.

**Figure 7-11**  depicts the way the array is set up in memory when the program first starts to execute, and what happens when the loop writes data beyond the boundary of the array.

**Figure 7-11 Writing data beyond the bounds of an array**



Although C++ programs are fast and efficient, the absence of safeguards such as array bounds checking usually proves to be a bad thing. It's easy for C++ programmers to make careless mistakes that allow programs to access areas of memory that are supposed to be off-limits. You must always make sure that any time you assign values to array elements, the values are written within the array's boundaries.

# Watch for Off-by-One Errors

In working with arrays, a common type of mistake is the *off-by-one error*. This is an easy mistake to make because array subscripts start at 0 rather than 1. For example, look at the following code:

```
// This code has an off-by-one error.  
const int SIZE = 100;  
int numbers[SIZE];  
for (int count = 1; count <= SIZE; count++)  
    numbers[count] = 0;
```

The intent of this code is to create an array of integers with 100 elements, and store the value 0 in each element. However, this code has an off-by-one error. The loop uses its counter variable, `count`, as a subscript with the `numbers` array. During the loop's execution, the variable `count` takes on the values 1 through 100, when it should take on the values 0 through 99. As a result, the first element, which is at subscript 0, is skipped. In addition, the loop attempts to use 100 as a subscript during the last iteration. Because 100 is an invalid subscript, the program will write data beyond the array's boundaries.



7.1 Define the following arrays:

- A. `empNums`, a 100-element array of `int`s
- B. `payRates`, a 25-element array of `float`s
- C. `miles`, a 14-element array of `long`s
- D. `cityName`, a 26-element array of `string` objects
- E. `lightYears`, a 1,000-element array of `double`s

7.2 What's wrong with the following array definitions?

```
int readings[-1];  
float measurements[4.5];  
int size;  
string names[size];
```

7.3 What would the valid subscript values be in a 4-element array of `double`s?

7.4 What is the difference between an array's size declarator and a subscript?

7.5 What is "array bounds checking"? Does C++ perform it?

7.6 What is the output of the following code?

```
int values[5], count;  
for (count = 0; count < 5; count++)  
    values[count] = count + 1;  
for (count = 0; count < 5; count++)  
    cout << values[count] << endl;
```

7.7 The following program skeleton contains a 20-element array of `int`s called `fish`. When completed, the program should ask how many fish were caught by fishermen 1 through 20, and store this data in the array. Complete the program.

```

#include <iostream>
using namespace std;
int main()
{
    const int NUM_FISH = 20;
    int fish[NUM_FISH];
    // You must finish this program. It should ask how
    // many fish were caught by fishermen 1-20, and
    // store this data in the array fish.
    return 0;
}

```

7.8 Define the following arrays:

- A. ages, a 10-element array of ints initialized with the values 5, 7, 9, 14, 15, 17, 18, 19, 21, and 23.
- B. temps, a 7-element array of floats initialized with the values 14.7, 16.3, 18.43, 21.09, 17.9, 18.76, and 26.7.
- C. alpha, an 8-element array of chars initialized with the values 'J', 'B', 'L', 'A', '\*', '\$', 'H', and 'M'.

7.9 Is each of the following a valid or invalid array definition? (If a definition is invalid, explain why.)

- A. `int numbers[10] = {0, 0, 1, 0, 0, 1, 0, 0, 1, 1};`
- B. `int matrix[5] = {1, 2, 3, 4, 5, 6, 7};`
- C. `double radii[10] = {3.2, 4.7};`
- D. `int table[7] = {2, , , 27, , 45, 39};`
- E. `char codes[] = {'A', 'X', '1', '2', 's'};`
- F. `int blanks[];`

## 11 7.4 The Range-Based `for` Loop

### Concept:

The range-based `for` loop is a loop that iterates once for each element in an array. Each time the loop iterates, it copies an element from the array to a variable. The range-based `for` loop was introduced in C++ 11.

C++ 11 provides a specialized version of the `for` loop that, in many circumstances, simplifies array processing. It is known as the *range-based for loop*. When you use the range-based `for` loop with an array, the loop automatically iterates once for each element in the array. For example, if you use the range-based `for` loop with an 8-element array, the loop will iterate 8 times. Because the range-based `for` loop automatically knows the number of elements in an array, you do not have to use a counter variable to control its iterations, as with a regular `for` loop. Additionally, you do not have to worry about stepping outside the bounds of an array when you use the range-based `for` loop.

The range-based `for` loop is designed to work with a built-in variable known as the *range variable*. Each time the range-based `for` loop iterates, it copies an array element to the range variable. For example, the first time the loop iterates, the range variable will contain the value of element 0, the second time the loop iterates, the range variable will contain the value of element 1, and so forth.

Here is the general format of the range-based `for` loop:

```
for (dataType rangeVariable : array)
    statement;
```

Let's look at the syntax more closely as follows:

- `dataType` is the data type of the range variable. It must be the same as the data type of the array elements, or a type to which the elements can automatically be converted.
- `rangeVariable` is the name of the range variable. This variable will receive the value of a different array element during each loop iteration. During the first loop iteration, it receives the value of the first element; during the second iteration, it receives the value of the second element, and so forth.
- `array` is the name of an array on which you wish the loop to operate. The loop will iterate once for every element in the array.
- `statement` is a statement that executes during a loop iteration. If you need to execute more than one statement in the loop, enclose the statements in a set of braces.



For example, assume that you have the following array definition:

```
int numbers[] = { 3, 6, 9 };
```

You can use the following range-based `for` loop to display the contents of the `numbers` array:

```
for (int val : numbers)
    cout << val << endl;
```

Because the `numbers` array has three elements, this loop will iterate three times. The first time it iterates, the `val` variable will receive the value in `numbers[0]`. During the second iteration, `val` will receive the value in `numbers[1]`. During the third iteration, `val` will receive the value in `numbers[2]`. The code's output will be as follows:

```
3
6
9
```

Here is an example of a range-based `for` loop that executes more than one statement in the body of the loop:


```
int[] numbers = { 3, 6, 9 };  
for (int val : numbers)  
{  
    cout << "The next value is ";  
    cout << val << endl;  
}
```

This code will produce the following output:

```
The next value is 3  
The next value is 6  
The next value is 9
```

If you wish, you can use the `auto` key word to specify the range variable's data type. Here is an example:

```
int[] numbers = { 3, 6, 9 };  
for (auto val : numbers)  
    cout << val << endl;
```


**Program 7-10**  demonstrates the range-based `for` loop by displaying the elements of an `int` array.

## Program 7-10

```
1 // This program demonstrates the range-based for
loop.
2 #include <iostream>
3 using namespace std;
4
5 int main()
6 {
7     // Define an array of integers.
8     int numbers[] = { 10, 20, 30, 40, 50 };
9
10    // Display the values in the array.
11    for (int val : numbers)
12        cout << val << endl;
13
14    return 0;
15 }
```

## Program Output

```
10
20
30
40
50
```

**Program 7-11**  shows another example of the range-based `for` loop. This program displays the elements of a `string` array.

## Program 7-11

```
1 // This program demonstrates the range-based for
loop.
2 #include <iostream>
3 #include <string>
4 using namespace std;
5
6 int main()
7 {
8     string planets[] = { "Mercury", "Venus",
"Earth", "Mars",
9         "Jupiter", "Saturn",
"Uranus",
10        "Neptune", "Pluto (a
dwarf planet)" };
11
12     cout << "Here are the planets:\n";
13
14     // Display the values in the array.
15     for (string val : planets)
16         cout << val << endl;
17
18     return 0;
19 }
```

## Program Output

```
Here are the planets:
```

```
Mercury
```

```
Venus
```

```
Earth
```

```
Mars
```

```
Jupiter
```

```
Saturn
```

```
Uranus
```

```
Neptune
```

```
Pluto (a dwarf planet)
```

# Modifying an Array with a Range-Based `for` Loop

As the range-based `for` loop executes, its range variable contains only a copy of an array element. As a consequence, you cannot use a range-based `for` loop to modify the contents of an array unless you declare the range variable as a reference. Recall from [Chapter 6](#) that a reference variable is an alias for another value. Any changes made to the reference variable are actually made to the value for which it is an alias.

To declare the range variable as a reference variable, simply write an ampersand (`&`) in front of its name in the loop header. [Program 7-12](#) shows an example.

## Program 7-12

```
1 // This program uses a range-based for loop to
2 // modify the contents of an array.
3 #include <iostream>
4 using namespace std;
5
6 int main()
7 {
8     const int SIZE = 5;
9     int numbers[5];
10
11     // Get values for the array.
12     for (int &val : numbers)
13     {
14         cout << "Enter an integer value: ";
15         cin >> val;
16     }
17
18     // Display the values in the array.
19     cout << "Here are the values you
20 entered:\n";
21     for (int val : numbers)
22         cout << val << endl;
```



```
23     return 0;
24 }
```

### Program Output with Example Input Shown in Bold

```
Enter an integer value: 1 Enter
Enter an integer value: 2 Enter
Enter an integer value: 3 Enter
Enter an integer value: 4 Enter
Enter an integer value: 5 Enter
```

```
Here are the values you entered:
```

```
1
2
3
4
5
```

Notice in line 12 the range variable, `val`, has an ampersand (`&`) written in front of its name. This declares `val` as a reference variable. As the loop executes, the `val` variable will not merely contain a copy of an array element, but it will be an alias for the element. Any changes made to the `val` variable will actually be made to the array element it references.

Also notice in line 20, we did not declare `val` as a reference variable (there is no ampersand written in front of the variable's name).

Because the loop is simply displaying the array elements, and does not need to change the array's contents, there is no need to make `val` a reference variable.

# The Range-Based `for` Loop versus the Regular `for` Loop

The range-based `for` loop can be used in any situation where you need to step through the elements of an array, and you do not need to use the element subscripts. It will not work, however, in situations where you need the element subscript for some purpose. In those situations, you need to use the regular `for` loop.



## **Note:**

You can use the `auto` key word with a reference range variable. For example, the code in lines 12 through 16 in [Program 7-12](#) could have been written like this:

```
for (auto &val : numbers)
{
    cout << "Enter an integer value: ";
    cin >> val;
}
```

## 7.5 Processing Array Contents

### Concept:

Individual array elements are processed like any other type of variable.

Processing array elements is no different than processing other variables. For example, the following statement multiplies `hours[3]` by the variable `rate`:

```
pay = hours[3] * rate;
```

And the following are examples of pre-increment and post-increment operations on array elements:

```
int score[5] = {7, 8, 9, 10, 11};  
  
++score[2]; // Pre-increment operation on the value in  
score[2]  
  
score[4]++; // Post-increment operation on the value in  
score[4]
```




## Note:

When using increment and decrement operators, be careful not to confuse the subscript with the array element. For example, the following statement decrements the variable `count`, but does nothing to the value in `amount[count]`.

```
amount[count--];
```

To decrement the value stored in `amount[count]`, use the following statement:

```
amount[count]--;
```

**Program 7-13**  demonstrates the use of array elements in a simple mathematical statement. A loop steps through each element of the array, using the elements to calculate the gross pay of five employees.

## Program 7-13

```
1 // This program stores, in an array, the hours
worked by
2 // employees who all make the same hourly
wage.
3 #include <iostream>
4 #include <iomanip>
5 using namespace std;
6
7 int main()
8 {
9     const int NUM_EMPLOYEES = 5; // Number of
employees
10    int hours[NUM_EMPLOYEES]; // Array to
hold hours
11    double payrate; // Hourly pay
rate
12    double grossPay; // To hold
the gross pay
13
14    // Input the hours worked.
15    cout << "Enter the hours worked by ";
16    cout << NUM_EMPLOYEES << " employees who
all\n";
```

```
17     cout << "earn the same hourly rate.\n";
18     for (int index = 0; index < NUM_EMPLOYEES;
index++)
19     {
20         cout << "Employee #" << (index + 1) <<
": ";
21         cin >> hours[index];
22     }
23
24     // Input the hourly rate for all
employees.
25     cout << "Enter the hourly pay rate for all
the employees: ";
26     cin >> payrate;
27
28     // Display each employee's gross pay.
29     cout << "Here is the gross pay for each
employee:\n";
30     cout << fixed << showpoint <<
setprecision(2);
31     for (int index = 0; index < NUM_EMPLOYEES;
index++)
32     {
33         grossPay = hours[index] * payrate;
34         cout << "Employee #" << (index + 1);
35         cout << ": $" << grossPay << endl;
36     }
```



```
37     return 0;
38 }
```

## Program Output with Example Input Shown in Bold

```
Enter the hours worked by 5 employees who
all
earn the same hourly rate.
Employee #1: 5 Enter
Employee #2: 10 Enter
Employee #3: 15 Enter
Employee #4: 20 Enter
Employee #5: 40 Enter
Enter the hourly pay rate for all the
employees: 12.75 Enter
Here is the gross pay for each employee:
Employee #1: $63.75
Employee #2: $127.50
Employee #3: $191.25
Employee #4: $255.00
Employee #5: $510.00
```

The following statement in line 33 assigns the value of `hours[index] times payRate` to the `grossPay` variable:

```
grossPay = hours[index] * payRate;
```

Array elements may also be used in relational expressions. For example, the following `if` statement tests `cost[20]` to determine whether it is less than `cost[0]`:

```
if (cost[20] < cost[0])
```

And the following statement sets up a `while` loop to iterate as long as `value[place]` does not equal 0:

```
while (value[place] != 0)
```

# Thou Shall Not Assign

The following code defines two integer arrays: `newValues` and `oldValues`. `newValues` is uninitialized, and `oldValues` is initialized with 10, 100, 200, and 300.

```
const int SIZE = 4;
int oldValues[SIZE] = {10, 100, 200, 300};
int newValues[SIZE];
```

At first glance, it might appear that the following statement assigns the contents of the array `oldValues` to `newValues`:

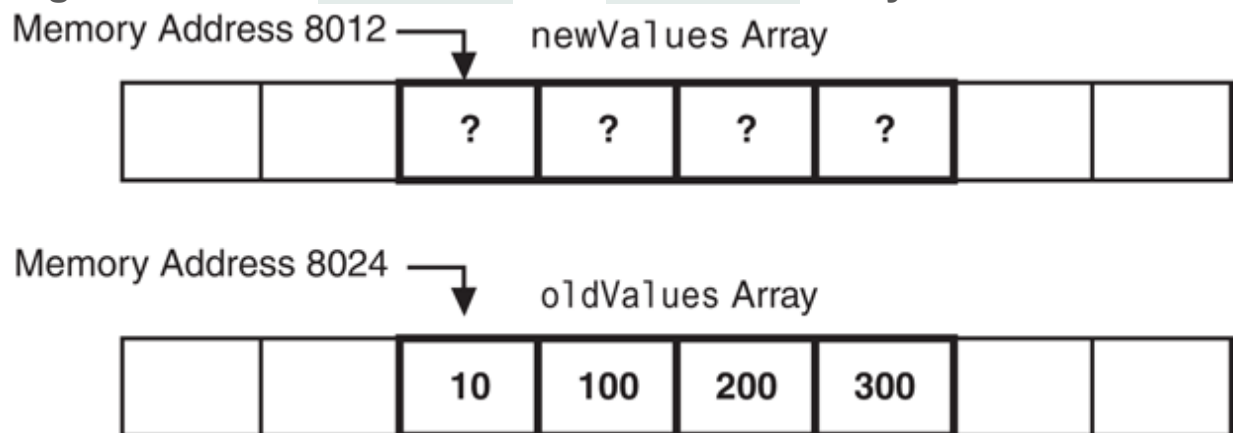
```
newValues = oldValues; // Wrong!
```

Unfortunately, this statement will not work. The only way to assign one array to another is to assign the individual elements in the arrays. Usually, this is best done with a loop, such as:

```
for (int count = 0; count < SIZE; count++)
    newValues[count] = oldValues[count];
```

The reason the assignment operator will not work with an entire array at once is complex, but important to understand. Anytime the name of an array is used without brackets and a subscript, *it is seen as the array's beginning memory address*. To illustrate this, consider the definition of the arrays `newValues` and `oldValues` above. **Figure 7-12** depicts the two arrays in memory.

**Figure 7-12** The `newValues` and `oldValues` arrays



In the figure, `newValues` is shown starting at memory address 8012 and `oldValues` is shown starting at 8024. (Of course, these are just arbitrary addresses, picked for illustration purposes. In reality, the addresses would probably be different.) **Table 7-2** shows various expressions that use the names of these arrays and their values.

### Table 7-2 Array Expressions

Because the name of an array without the brackets and subscript stands for the array's starting memory address, the statement

```
newValues = oldValues;
```

is interpreted by C++ as

```
8012 = 8024;
```

The statement will not work, because you cannot change the starting memory address of an array.

# Printing the Contents of an Array

Suppose we have the following array definition:

```
const int SIZE = 5;  
int numbers [SIZE] = {10, 20, 30, 40, 50};
```

You now know that an array's name is seen as the array's beginning memory address. This explains why the following statement cannot be used to display the contents of the `numbers` array.

```
cout << numbers << endl; //Wrong!
```

When this statement executes, `cout` will display the array's memory address, not the array's contents. You must use a loop to display the contents of each of the array's elements, as follows:

```
for (int count = 0; count < SIZE; count++)  
    cout << numbers[count] << endl;
```

**11** In C++ 11, you can use the range-based `for` loop to display an array's contents, as shown here:

```
for (int val : numbers)
    cout << val << endl;
```

# Summing the Values in a Numeric Array

To sum the values in an array, you must use a loop with an accumulator variable. The loop adds the value in each array element to the accumulator. For example, assume the following statements appear in a program, and values have been stored in the `units` array:

```
const int NUM_UNITS = 24;  
int units[NUM_UNITS];
```

The following code uses a regular `for` loop to add the values of each element in the array to the `total` variable. When the code is finished, `total` will contain the sum of the `units` array's elements.

```
int total = 0; // Initialize accumulator  
for (int count = 0; count < NUM_UNITS; count++)  
    total += units[count];
```

**11** In C++ 11, you can use the range-based `for` loop, as shown below. When the code is finished, `total` will contain the sum of the



`units` array's elements.

```
int total = 0; // Initialize accumulator
for (int val : units)
    total += val;
```



**Note:**

The first statement in both of these code segments sets `total` to 0. Recall from [Chapter 5](#) that an accumulator variable must be set to 0 before it is used to keep a running total, or the sum will not be correct.

# Getting the Average of the Values in a Numeric Array

The first step in calculating the average of all the values in an array is to sum the values. The second step is to divide the sum by the number of elements in the array. Assume the following statements appear in a program, and values have been stored in the `scores` array:

```
const int NUM_SCORES = 10;
double scores[NUM_SCORES];
```

The following code calculates the average of the values in the `scores` array. When the code completes, the average will be stored in the `average` variable.

```
double total = 0;    // Initialize accumulator
double average;     // Will hold the average
for (int count = 0; count < NUM_SCORES; count++)
    total += scores[count];
average = total / NUM_SCORES;
```

Notice the last statement, which divides `total` by `NUM_SCORES`, is not inside the loop. This statement should only execute once, after the loop has finished its iterations.

**11** In C++ 11, you can use the range-based `for` loop, as shown below. When the code completes, the average will be stored in the `average` variable.

```
double total = 0; // Initialize accumulator
double average; // Will hold the average
for (int val : scores)
    total += val;
average = total / NUM_SCORES;
```

# Finding the Highest and Lowest Values in a Numeric Array

The algorithms for finding the highest and lowest values in an array are very similar. First, let's look at code for finding the highest value in an array. Assume the following code exists in a program, and values have already been stored in the `numbers` array:

```
const int SIZE = 50;  
int numbers[SIZE];
```

The code to find the highest value in the array is as follows:

```
int count;  
int highest;  
highest = numbers[0];  
for (count = 1; count < SIZE; count++)  
{  
    if (numbers[count] > highest)  
        highest = numbers[count];  
}
```

First, we copy the value in the first array element to the variable `highest`. Then, the loop compares all of the remaining array elements, beginning at subscript 1, to the value in `highest`. Each time it finds a value in the array that is greater than `highest`, it copies that value to `highest`. When the loop has finished, `highest` will contain the highest value in the array.

The following code finds the lowest value in the array. As you can see, it is nearly identical to the code for finding the highest value.

```
int count;
int lowest;
lowest = numbers[0];
for (count = 1; count < SIZE; count++)
{
    if (numbers[count] < lowest)
        lowest = numbers[count];
}
```

When the loop has finished, `lowest` will contain the lowest value in the array.

# Partially Filled Arrays

Sometimes you need to store a series of items in an array, but you do not know the number of items that there are. As a result, you do not know the exact number of elements needed for the array. One solution is to make the array large enough to hold the largest possible number of items. This can lead to another problem, however. If the actual number of items stored in the array is less than the number of elements, the array will be only partially filled. When you process a partially filled array, you must only process the elements that contain valid data items.

A partially filled array is normally used with an accompanying integer variable that holds the number of items stored in the array. For example, suppose a program uses the following code to create an array with 100 elements, and an `int` variable named `count` that will hold the number of items stored in the array.

```
const int SIZE = 100;
int numbers[SIZE];
int count = 0;
```

Each time we add an item to the array, we must increment `count`. The following code demonstrates this:

```

int num;

cout << "Enter a number or -1 to quit: ";

cin >> num;

while (num != -1 && count < SIZE)
{
    count++;

    numbers[count - 1] = num;

    cout << "Enter a number or -1 to quit: ";

    cin >> num;
}

```


Each iteration of this sentinel-controlled loop allows the user to enter a number to be stored in the array, or `-1` to quit. The `count` variable is incremented then used to calculate the subscript of the next available element in the array. When the user enters `-1`, or `count` exceeds 99, the loop stops. The following code displays all of the valid items in the array:

```

for (int index = 0; index < count; index++)
{
    cout << numbers[index] << endl;
}

```

Notice this code uses `count` to determine the maximum array subscript to use.

**Program 7-14**  shows how this technique can be used to read an unknown number of items from a file into an array. The program reads values from the file numbers.txt.



## Program 7-14

```
1 //This program reads data from a file into an
array.
2 #include <iostream>
3 #include <fstream>
4 using namespace std;
5
6 int main()
7 {
8     const int ARRAY_SIZE = 100; // Array size
9     int numbers[ARRAY_SIZE];    // Array with
100 elements
10     int count = 0;              // Loop
counter variable
11     ifstream inputFile;        // Input file
stream object
12
13     inputFile.open("numbers.txt"); // Open the
file.
14
15     // Read the numbers from the file into the
array.
16     // After this loop executes, the count
variable will hold
```

```
17     // the number of values that were stored
in the array.
18     while (count < ARRAY_SIZE && inputFile >>
numbers[count])
19         count++;
20
21     // Close the file.
22     inputFile.close();
23
24     // Display the numbers read.
25     cout << "The numbers are: ";
26     for (int index = 0; index < count;
index++)
27         cout << numbers[index] << " ";
28     cout << endl;
29     return 0;
30 }
```

## Program Output

```
The numbers are: 47 89 65 36 12 25 17 8 62
10 87 62
```

Look closer at the `while` loop that begins in line 18. It repeats as long as `count` is less than `ARRAY_SIZE` and the end of the file has not been encountered. The first part of the `while` loop's test expression, `count < ARRAY_SIZE`, prevents the loop from writing outside the array boundaries. Recall from [Chapter 4](#) that the `&&` operator performs short-circuit evaluation, so the second part of the `while` loop's test expression, `inputFile >> values[count]`, will be executed only if `count` is less than `ARRAY_SIZE`.

# Comparing Arrays

We have already noted that you cannot simply assign one array to another array. You must assign each element of the first array to an element of the second array. In addition, you cannot use the `==` operator with the names of two arrays to determine whether the arrays are equal. For example, the following code appears to compare two arrays, but in reality it does not:

```
int firstArray[] = { 5, 10, 15, 20, 25 };
int secondArray[] = { 5, 10, 15, 20, 25 };
if (firstArray == secondArray) // This is a mistake.
    cout << "The arrays are the same.\n";
else
    cout << "The arrays are not the same.\n";
```

When you use the `==` operator with array names, the operator compares the beginning memory addresses of the arrays, not the contents of the arrays. The two array names in this code will obviously have different memory addresses. Therefore, the result of the expression `firstArray == secondArray` is false, and the code reports that the arrays are not the same.

To compare the contents of two arrays, you must compare the elements of the two arrays. For example, look at the following code:

```

const int SIZE = 5;

int firstArray[SIZE] = { 5, 10, 15, 20, 25 };
int secondArray[SIZE] = { 5, 10, 15, 20, 25 };

bool arraysEqual = true; // Flag variable

int count = 0;           // Loop counter variable

// Determine whether the elements contain the same data.
while (arraysEqual && count < SIZE)
{
    if (firstArray[count] != secondArray[count])
        arraysEqual = false;
    count++;
}

if (arraysEqual)
    cout << "The arrays are equal.\n";
else
    cout << "The arrays are not equal.\n";

```

This code determines whether `firstArray` and `secondArray` contain the same values. A `bool` variable, `arraysEqual`, which is initialized to `true`, is used to signal whether the arrays are equal. Another variable, `count`, which is initialized to 0, is used as a loop counter variable.

Then a `while` loop begins. The loop executes as long as `arraysEqual` is `true` and the counter variable `count` is less than `SIZE`. During each iteration, it compares a different set of

corresponding elements in the arrays. When it finds two corresponding elements that have different values, the `arraysEqual` variable is set to `false`. After the loop finishes, an `if` statement examines the `arraysEqual` variable. If the variable is `true`, then the arrays are equal and a message indicating so is displayed. Otherwise, they are not equal, so a different message is displayed.

## 7.6 Focus on Software Engineering: Using Parallel Arrays

### Concept:

By using the same subscript, you can build relationships between data stored in two or more arrays.

Sometimes it's useful to store related data in two or more arrays. It's especially useful when the related data is of unlike types. For example, [Program 7-15](#) is another variation of the payroll program. It uses two arrays: one to store the hours worked by each employee (as `int`s), and another to store each employee's hourly pay rate (as `double`s).

## Program 7-15

```
1 // This program uses two parallel arrays: one for hours
2 // worked and one for pay rate.
3 #include <iostream>
4 #include <iomanip>
5 using namespace std;
6
7 int main()
8 {
9     const int NUM_EMPLOYEES = 5;    // Number of employees
10    int hours[NUM_EMPLOYEES];      // Holds hours worked
11    double payRate[NUM_EMPLOYEES]; // Holds pay rates
12
13    // Input the hours worked and the hourly pay rate.
14    cout << "Enter the hours worked by " << NUM_EMPLOYEES
15         << " employees and their\n"
16         << "hourly pay rates.\n";
17    for (int index = 0; index < NUM_EMPLOYEES; index++)
18    {
19        cout << "Hours worked by employee #" << (index+1) << ": ";
20        cin >> hours[index];
21        cout << "Hourly pay rate for employee #" << (index+1) << ": ";
22        cin >> payRate[index];
23    }
24
25    // Display each employee's gross pay.
26    cout << "Here is the gross pay for each employee:\n";
27    cout << fixed << showpoint << setprecision(2);
28    for (int index = 0; index < NUM_EMPLOYEES; index++)
29    {
30        double grossPay = hours[index] * payRate[index];
31        cout << "Employee #" << (index + 1);
32        cout << ": $" << grossPay << endl;
33    }
34    return 0;
35 }
```



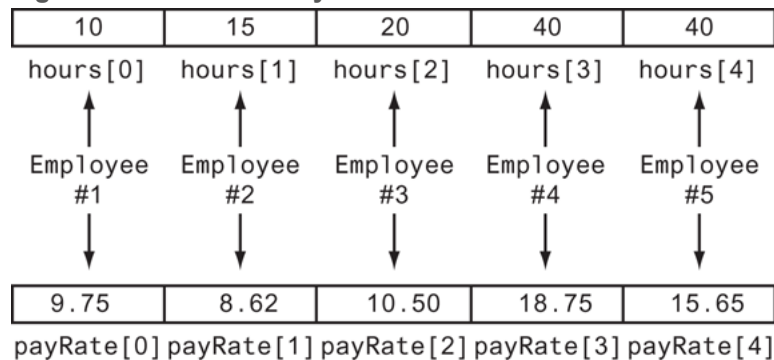
## Program Output with Example Input Shown in Bold

```
Enter the hours worked by 5 employees and their
hourly pay rates.
Hours worked by employee #1: 10 Enter
Hourly pay rate for employee #1: 9.75 Enter
Hours worked by employee #2: 15 Enter
Hourly pay rate for employee #2: 8.62 Enter
Hours worked by employee #3: 20 Enter
Hourly pay rate for employee #3: 10.50 Enter
Hours worked by employee #4: 40 Enter
Hourly pay rate for employee #4: 18.75 Enter
Hours worked by employee #5: 40 Enter
Hourly pay rate for employee #5: 15.65 Enter
Here is the gross pay for each employee:
Employee #1: $97.50
Employee #2: $129.30
Employee #3: $210.00
Employee #4: $750.00
Employee #5: $626.00
```

Notice in the loops the same subscript is used to access both arrays. That's because the data for one employee is stored in the same relative position in each array. For example, the hours worked by employee #1 are stored in `hours[0]`, and the same employee's pay rate is stored in `payRate[0]`. The subscript relates the data in both arrays.

This concept is illustrated in [Figure 7-13](#).

**Figure 7-13 Parallel arrays**





7.10 Given the following array definition:

```
int values[] = {2, 6, 10, 14};
```

What does each of the following display?

- A. `cout << values[2];`
- B. `cout << ++values[0];`
- C. `cout << values[1]++;`
- D. `x = 2;`  
`cout << values[++x];`

7.11 Given the following array definition:

```
int nums[5] = {1, 2, 3};
```

What will the following statement display?

```
cout << nums[3];
```

7.12 What is the output of the following code? (You may need to use a calculator.)

```
double balance[5] = {100.0, 250.0, 325.0, 500.0, 1100.0};  
const double INTRATE = 0.1;  
  
cout << fixed << showpoint << setprecision(2);  
for (int count = 0; count < 5; count++)  
    cout << (balance[count] * INTRATE) << endl;
```

7.13 What is the output of the following code? (You may need to use a calculator.)

```
const int SIZE = 5;
int time[SIZE] = {1, 2, 3, 4, 5},
    speed[SIZE] = {18, 4, 27, 52, 100},
    dist[SIZE];
for (int count = 0; count < SIZE; count++)
    dist[count] = time[count] * speed[count];
for (int count = 0; count < SIZE; count++)
{
    cout << time[count] << " ";
    cout << speed[count] << " ";
    cout << dist[count] << endl;
}
```

## 7.7 Arrays as Function Arguments

### Concept:

To pass an array as an argument to a function, pass the name of the array.



### Passing an Array to a Function

Quite often, you'll want to write functions that process the data in arrays. For example, functions could be written to put values in an array, display an array's contents on the screen, total all of an array's elements, or calculate their average. Usually, such functions accept an array as an argument.

When a single element of an array is passed to a function, it is handled like any other variable. For example, [Program 7-16](#) shows a loop that passes one element of the array `numbers` to the function `showValue` each time the loop iterates.

## Program 7-16

```
1 // This program demonstrates that an array element is passed
2 // to a function like any other variable.
3 #include <iostream>
4 using namespace std;
5
6 void showValue(int); // Function prototype
7
8 int main()
9 {
10     const int SIZE = 8;
11     int numbers[SIZE] = {5, 10, 15, 20, 25, 30, 35, 40};
12
13     for (int index = 0; index < SIZE; index++)
14         showValue(numbers[index]);
15     return 0;
16 }
17
18 //*****
19 // Definition of function showValue.      *
20 // This function accepts an integer argument. *
21 // The value of the argument is displayed. *
22 //*****
23
24 void showValue(int num)
25 {
26     cout << num << " ";
27 }
```

## Program Output

```
5 10 15 20 25 30 35 40
```

Each time `showValue` is called in line 14, a copy of an array element is passed into the parameter variable `num`. The `showValue` function simply displays the contents of `num` and doesn't work directly with the array element itself. (In other words, the array element is passed by value.)

If the function were written to accept the entire array as an argument, however, the parameter would be set up differently. In the following function definition, the parameter `nums` is followed by an empty set of brackets. This indicates that the argument will be an array, not a single value.

```
void showValues(int nums[], int size)
{
    for (int index = 0; index < size; index++)
        cout << nums[index] << " ";
    cout << endl;
}
```

The reason there is no size declarator inside the brackets of `nums` is because `nums` is not actually an array. It's a special variable that can accept the address of an array. When an entire array is passed to a function, it is not passed by value, but passed by reference. Imagine the CPU time and memory that would be necessary if a copy of a 10,000-element array were created each time it was passed to a function! Instead, only the starting memory address of the array is passed. [Program 7-17](#) shows the function `showValues` in use.



### Note:

Notice in the function prototype, empty brackets appear after the data type of the array parameter. This indicates that `showValues` accepts the address of an array of integers.

## Program 7-17

```
1 // This program demonstrates an array being passed to a function.
2 #include <iostream>
3 using namespace std;
4
5 void showValues(int [], int); // Function prototype
6
7 int main()
8 {
9     const int ARRAY_SIZE = 8;
10    int numbers[ARRAY_SIZE] = {5, 10, 15, 20, 25, 30, 35, 40};
11
12    showValues(numbers, ARRAY_SIZE);
13    return 0;
14 }
15
16 //*****
17 // Definition of function showValue. *
18 // This function accepts an array of integers and *
19 // the array's size as its arguments. The contents *
20 // of the array are displayed. *
21 //*****
22
23 void showValues(int nums[], int size)
24 {
25     for (int index = 0; index < size; index++)
26         cout << nums[index] << " ";
27     cout << endl;
28 }
```

## Program Output

```
5 10 15 20 25 30 35 40
```

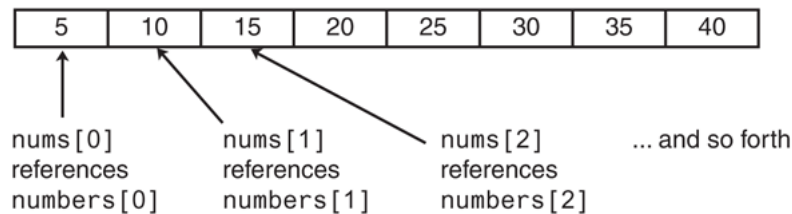
In [Program 7-17](#), the function `showValues` is called in the following statement that appears in line 12:

```
showValues(numbers, ARRAY_SIZE);
```

The first argument is the name of the array. Remember, in C++ the name of an array without brackets and a subscript is actually the beginning address of the array. In this function call, the address of the `numbers` array is being passed as the first argument to the function. The second argument is the size of the array.

In the `showValues` function, the beginning address of the `numbers` array is copied into the `nums` parameter variable. The `nums` variable is then used to reference the `numbers` array. [Figure 7-14](#) illustrates the relationship between the `numbers` array and the `nums` parameter variable. When the contents of `nums[0]` are displayed, it is actually the contents of `numbers[0]` that appear on the screen.

**Figure 7-14 Relationship between the `numbers` array and the `nums` parameter**  
numbers Array of eight integers



### Note:

Although `nums` is not a reference variable, it works like one.

The `nums` parameter variable in the `showValues` function can accept the address of any integer array, and can be used to reference that array. So, we can use the `showValues` function to display the contents of any integer array by passing the name of the array and its size as arguments. [Program 7-18](#) uses the function to display the contents of two different arrays.



## Program 7-18

```
1 // This program demonstrates the showValues function being
2 // used to display the contents of two arrays.
3 #include <iostream>
4 using namespace std;
5
6 void showValues(int [], int); // Function prototype
7
8 int main()
9 {
10     const int SIZE1 = 8; // Size of set1 array
11     const int SIZE2 = 5; // Size of set2 array
12     int set1[SIZE1] = {5, 10, 15, 20, 25, 30, 35, 40};
13     int set2[SIZE2] = {2, 4, 6, 8, 10};
14
15     // Pass set1 to showValues.
16     showValues(set1, SIZE1);
17
18     // Pass set2 to showValues.
19     showValues(set2, SIZE2);
20     return 0;
21 }
22
23 //*****
24 // Definition of function showValues. *
25 // This function accepts an array of integers and *
26 // the array's size as its arguments. The contents *
27 // of the array are displayed. *
28 //*****
29
30 void showValues(int nums[], int size)
31 {
32     for (int index = 0; index < size; index++)
33         cout << nums[index] << " ";
34     cout << endl;
35 }
```

## Program Output

```
5 10 15 20 25 30 35 40  
2 4 6 8 10
```

Recall from [Chapter 6](#) that when a reference variable is used as a parameter, it gives the function access to the original argument. Any changes made to the reference variable are actually performed on the argument referenced by the variable. Array parameters work very much like reference variables. They give the function direct access to the original array. Any changes made with the array parameter are actually made on the original array used as the argument. The function `doubleArray` in [Program 7-19](#) uses this capability to double the contents of each element in the array.

## Program 7-19

```
1 // This program uses a function to double the value of
2 // each element of an array.
3 #include <iostream>
4 using namespace std;
5
6 // Function prototypes
7 void doubleArray(int [], int);
8 void showValues(int [], int);
9
10 int main()
11 {
12     const int ARRAY_SIZE = 7;
13     int set[ARRAY_SIZE] = {1, 2, 3, 4, 5, 6, 7};
14
15     // Display the initial values.
16     cout << "The array's values are:\n";
17     showValues(set, ARRAY_SIZE);
18
19     // Double the values in the array.
20     doubleArray(set, ARRAY_SIZE);
21
22     // Display the resulting values.
23     cout << "After calling doubleArray the values are:\n";
24     showValues(set, ARRAY_SIZE);
25
26     return 0;
27 }
28
29 /*******
30 // Definition of function doubleArray *
31 // This function doubles the value of each element *
32 // in the array passed into nums. The value passed *
33 // into size is the number of elements in the array. *
34 /*******
35
36 void doubleArray(int nums[], int size)
37 {
```

```
38     for (int index = 0; index < size; index++)
39         nums[index] *= 2;
40     }
41
42     //*****
43     // Definition of function showValues.      *
44     // This function accepts an array of integers and *
45     // the array's size as its arguments. The contents *
46     // of the array are displayed.            *
47     //*****
48
49     void showValues(int nums[], int size)
50     {
51         for (int index = 0; index < size; index++)
52             cout << nums[index] << " ";
53         cout << endl;
54     }
```

## Program Output

```
The array's values are:
1 2 3 4 5 6 7
After calling doubleArray the values are:
2 4 6 8 10 12 14
```

## Using `const` Array Parameters

Sometimes you want a function to be able to modify the contents of an array that is passed to it as an argument, and sometimes you don't. You can prevent a function from making changes to an array argument by using the `const` key word in the parameter declaration. Here is an example of the `showValues` function, shown previously, rewritten with a `const` array parameter:

```
void showValues(const int nums[], int size)
{
    for (int index = 0; index < size; index++)
        cout << nums[index] << " ";
    cout << endl;
}
```

When an array parameter is declared as `const`, the function is not allowed to make changes to the array's contents. If a statement in the function attempts to modify the array, an error will occur at compile time. As a precaution, you should always use `const` array parameters in any function that is not intended to modify its array argument. That way, the function will fail to compile if you inadvertently write code in it that modifies the array.

# Some Useful Array Functions

**Section 7.5** introduced you to algorithms such as summing an array and finding the highest and lowest values in an array. Now that you know how to pass an array as an argument to a function, you can write general purpose functions that perform those operations. The following *In the Spotlight* section shows an example.



## In the Spotlight:

### Processing an Array

Dr. LaClaire gives four exams during the semester in her chemistry class. At the end of the semester, she drops each student's lowest test score before averaging the scores. She has asked you to write a program that will read a student's four test scores as input, and calculate the average with the lowest score dropped. Here is the pseudocode algorithm that you developed:

Read the student's four test scores.


Calculate the total of the scores.

Find the lowest score.

Subtract the lowest score from the total. This gives the adjusted total.

Divide the adjusted total by 3. This is the average.

Display the average.

**Program 7-20**  shows the program, which is modularized. Rather than presenting the entire program at once, let's first examine the `main` function, then each additional function separately. Here is the first part of the program, including the `main` function:

## Program 7-20 (`main` function)

```
1 // This program gets a series of test scores and
2 // calculates the average of the scores with the
3 // lowest score dropped.
4 #include <iostream>
5 #include <iomanip>
6 using namespace std;
7
8 // Function prototypes
9 void getTestScores(double[], int);
10 double getTotal(const double[], int);
11 double getLowest(const double[], int);
12
13 int main()
14 {
15     const int SIZE = 4; // Array size
16     double testScores[SIZE], // Array of test scores
17         total, // Total of the scores
18         lowestScore, // Lowest test score
19         average; // Average test score
20
21     // Set up numeric output formatting.
22     cout << fixed << showpoint << setprecision(1);
23
24     // Get the test scores from the user.
25     getTestScores(testScores, SIZE);
26
27     // Get the total of the test scores.
28     total = getTotal(testScores, SIZE);
29
30     // Get the lowest test score.
31     lowestScore = getLowest(testScores, SIZE);
32
33     // Subtract the lowest score from the total.
34     total -= lowestScore;
35
36     // Calculate the average. Divide by 3 because
```



```

37     // the lowest test score was dropped.
38     average = total / (SIZE - 1);
39
40     // Display the average.
41     cout << "The average with the lowest score "
42           << "dropped is " << average << ".\n";
43
44     return 0;
45 }
46

```

Lines 15 through 19 define the following items:

- `SIZE`—an `int` constant that is used as an array size declarator
- `testScores`—a `double` array to hold the test scores
- `tOtal`—a `double` variable that will hold the test score totals
- `lowestScore`—a `double` variable that will hold the lowest test score
- `average`—a `double` variable that will hold the average of the test scores

Line 25 calls the `getTestScores` function, passing the `testScores` array and the value of the `SIZE` constant as arguments. The function gets the test scores from the user and stores them in the array.

Line 28 calls the `getTotal` function, passing the `testScores` array and the value of the `SIZE` constant as arguments. The function returns the total of the values in the array. This value is assigned to the `total` variable.

Line 31 calls the `getLowest` function, passing the `testScores` array and the value of the `SIZE` constant as arguments. The function returns the lowest value in the array. This value is assigned to the `lowestScore` variable.

Line 34 subtracts the lowest test score from the `total` variable. Then, line 38 calculates the average by dividing `total` by `SIZE - 1`. (The program divides by `SIZE - 1` because the lowest test score was dropped.) Lines 41 and 42 display the average.

The `getTestScores` function appears next, as shown here:

## Program 7-20 (`getTestScores` function)

```
47 //*****
48 // The getTestScores function accepts an array and its size *
49 // as arguments. It prompts the user to enter test scores, *
50 // which are stored in the array. *
51 //*****
52
53 void getTestScores(double scores[], int size)
54 {
55     // Loop counter
56     int index;
57
58     // Get each test score.
59     for(index = 0; index <= size - 1; index++)
60     {
61         cout << "Enter test score number "
62             << (index + 1) << ": ";
63         cin >> scores[index];
64     }
65 }
66
```

The `getTestScores` function has two parameters:

- `scores[]`—A `double` array
- `size`—An `int` specifying the size of the array that is passed into the `scores[]` parameter

The purpose of this function is to get a student's test scores from the user and store them in the array that is passed as an argument into the `scores[]` parameter.

The `getTotal` function appears next, as shown here:

## Program 7-20 (`getTotal` function)

```
67 //*****
68 // The getTotal function accepts a double array *
69 // and its size as arguments. The sum of the array's *
70 // elements is returned as a double. *
71 //*****
72
73 double getTotal(const double numbers[], int size)
74 {
75     double total = 0; // Accumulator
76
77     // Add each element to total.
78     for (int count = 0; count < size; count++)
79         total += numbers[count];
80
81     // Return the total.
82     return total;
83 }
84
```

The `getTotal` function has two parameters:

- `numbers[]`—A `const double` array
- `size`—An `int` specifying the size of the array that is passed into the `numbers[]` parameter

This function returns the total of the values in the array that is passed as an argument into the `numbers[]` parameter.

The `getLowest` function appears next, as shown here:

## Program 7-20 (`getLowest` function)

```
85 //*****
86 // The getLowest function accepts a double array and *
87 // its size as arguments. The lowest value in the *
88 // array is returned as a double. *
89 //*****
90
91 double getLowest(const double numbers[], int size)
92 {
93     double lowest; // To hold the lowest value
94
95     // Get the first array's first element.
96     lowest = numbers[0];
97
98     // Step through the rest of the array. When a
99     // value less than lowest is found, assign it
100    // to lowest.
101    for (int count = 1; count < size; count++)
102    {
103        if (numbers[count] < lowest)
104            lowest = numbers[count];
105    }
106
107    // Return the lowest value.
108    return lowest;
109 }
```

The `getLowest` function has two parameters:

- `numbers[]`—A `const double` array
- `size`—An `int` specifying the size of the array that is passed into the `numbers[]` parameter

This function returns the lowest value in the array that is passed as an argument into the `numbers[]` parameter. Here is an example of the program's output:

## Program 7-20

### Program Output with Example Input Shown in Bold

```
Enter test score number 1: 92 Enter  
Enter test score number 2: 67 Enter  
Enter test score number 3: 75 Enter  
Enter test score number 4: 88 Enter  
The average with the lowest score dropped is 85.0.
```



7.14 Given the following array definitions:

```
double array1[4] = {1.2, 3.2, 4.2, 5.2};  
double array2[4];
```

Will the following statement work? If not, why?

```
array2 = array1;
```

7.15 When an array name is passed to a function, what is actually being passed?

7.16 When used as function arguments, are arrays passed by value?

7.17 What is the output of the following program? (You may need to consult the ASCII table in [Appendix A](#).)

```

#include <iostream>
using namespace std;
// Function prototypes
void fillArray(char [], int);
void showArray(const char [], int);
int main ()
{
    const int SIZE = 8;
    char prodCode[SIZE] = {'0', '0', '0', '0', '0', '0', '0', '0'};
    fillArray(prodCode, SIZE);
    showArray(prodCode, SIZE);
    return 0;
}
// Definition of function fillArray.
// (Hint: 65 is the ASCII code for 'A')
void fillArray(char arr[], int size)
{
    char code = 65;
    for (int k = 0; k < size; code++, k++)
        arr[k] = code;
}
// Definition of function showArray.
void showArray(const char codes[], int size)
{
    for (int k = 0; k < size; k++)
        cout << codes[k];
    cout << endl;
}

```

7.18 The following program skeleton, when completed, will ask the user to enter 10 integers, which are stored in an array. The function `avgArray`, which you must write, is to calculate and return the average of the numbers entered.

```
#include <iostream>
using namespace std;
// Write your function prototype here
int main()
{
    const int SIZE = 10;
    int userNums[SIZE];
    cout << "Enter 10 numbers: ";
    for (int count = 0; count < SIZE; count++)
    {
        cout << "#" << (count + 1) << " ";
        cin >> userNums[count];
    }
    cout << "The average of those numbers is ";
    cout << avgArray(userNums, SIZE) << endl;
    return 0;
}
//
// Write the function avgArray here.
//
```



## 7.8 Two-Dimensional Arrays

### Concept:

A two-dimensional array is like several identical arrays put together. It is useful for storing multiple sets of data.

An array is useful for storing and working with a set of data. Sometimes, though, it's necessary to work with multiple sets of data. For example, in a grade-averaging program, a teacher might record all of one student's test scores in an array of `double`s. If the teacher has 30 students, that means he or she will need 30 arrays of `double`s to record the scores for the entire class. Instead of defining 30 individual arrays, however, it would be better to define a two-dimensional array.

The arrays you have studied so far are one-dimensional arrays. They are called *one-dimensional* because they can only hold one set of data. Two-dimensional arrays, which are sometimes called *2D arrays*, can hold multiple sets of data. It's best to think of a two-dimensional array as having rows and columns of elements, as shown in [Figure 7-15](#). This figure shows an array of test scores, having three rows and four columns.

**Figure 7-15 Two-dimensional array**

	Column 0	Column 1	Column 2	Column 3
Row 0	scores[0] [0]	scores[0] [1]	scores[0] [2]	scores[0] [3]
Row 1	scores[1] [0]	scores[1] [1]	scores[1] [2]	scores[1] [3]
Row 2	scores[2] [0]	scores[2] [1]	scores[2] [2]	scores[2] [3]

The array depicted in [Figure 7-15](#) has three rows (numbered 0 through 2) and four columns (numbered 0 through 3). There are a total of 12 elements in the array.

To define a two-dimensional array, two size declarators are required. The first one is for the number of rows, and the second one is for the number of columns. Here is an example definition of a two-dimensional array with three rows and four columns:

```
double scores[3][4];  
           └──┬──┘  
           Rows Columns
```

The first size declarator specifies the number of rows, and the second size declarator specifies the number of columns. Notice each number is enclosed in its own set of brackets.

When processing the data in a two-dimensional array, each element has two subscripts: one for its row, and another for its column. In the `scores` array defined above, the elements in row 0 are referenced as

```
scores[0][0]
scores[0][1]
scores[0][2]
scores[0][3]
```

The elements in row 1 are

```
scores[1][0]
scores[1][1]
scores[1][2]
scores[1][3]
```

And the elements in row 2 are

```
scores[2][0]
scores[2][1]
scores[2][2]
scores[2][3]
```

The subscripted references are used in a program just like the references to elements in a single-dimensional array, except now you use two subscripts. The first subscript represents the row position, and the second subscript represents the column position. For example, the following statement assigns the value 92.25 to the element at row 2, column 1 of the `scores` array:

```
scores[2][1] = 92.25;
```

And the following statement displays the element at row 0, column 2:

```
cout << scores[0][2];
```

Programs that step through each element of a two-dimensional array usually do so with nested loops.

**Program 7-21** [□](#) is an example.

## Program 7-21

```
1 // This program demonstrates a two-dimensional array.
2 #include <iostream>
3 #include <iomanip>
4 using namespace std;
5
6 int main()
7 {
8     const int NUM_DIVS = 3;           // Number of divisions
9     const int NUM_QTRS = 4;          // Number of quarters
10    double sales[NUM_DIVS][NUM_QTRS]; // Array with 3 rows and 4 columns.
11    double totalSales = 0;           // To hold the total sales.
12    int div, qtr;                    // Loop counters.
13
14    cout << "This program will calculate the total sales of\n";
15    cout << "all the company's divisions.\n";
16    cout << "Enter the following sales information:\n\n";
17
18    // Nested loops to fill the array with quarterly
19    // sales figures for each division.
20    for (div = 0; div < NUM_DIVS; div++)
21    {
22        for (qtr = 0; qtr < NUM_QTRS; qtr++)
23        {
24            cout << "Division " << (div + 1);
25            cout << ", Quarter " << (qtr + 1) << ": $";
26            cin >> sales[div][qtr];
27        }
28        cout << endl; // Print blank line.
29    }
30
31    // Nested loops used to add all the elements.
32    for (div = 0; div < NUM_DIVS; div++)
33    {
34        for (qtr = 0; qtr < NUM_QTRS; qtr++)
35            totalSales += sales[div][qtr];
36    }
37
```

```
38     cout << fixed << showpoint << setprecision(2);
39     cout << "The total sales for the company are: $";
40     cout << totalSales << endl;
41     return 0;
42 }
```

### Program Output with Example Input Shown in Bold

```
This program will calculate the total sales of
all the company's divisions.
```

```
Enter the following sales data:
```

```
Division 1, Quarter 1: $31569.45 Enter
```

```
Division 1, Quarter 2: $29654.23 Enter
```

```
Division 1, Quarter 3: $32982.54 Enter
```

```
Division 1, Quarter 4: $39651.21 Enter
```

```
Division 2, Quarter 1: $56321.02 Enter
```

```
Division 2, Quarter 2: $54128.63 Enter
```

```
Division 2, Quarter 3: $41235.85 Enter
```

```
Division 2, Quarter 4: $54652.33 Enter
```

```
Division 3, Quarter 1: $29654.35 Enter
```

```
Division 3, Quarter 2: $28963.32 Enter
```

```
Division 3, Quarter 3: $25353.55 Enter
```

```
Division 3, Quarter 4: $32615.88 Enter
```

```
The total sales for the company are: $456782.34
```

When initializing a two-dimensional array, it helps to enclose each row's initialization list in a set of braces. Here is an example:

```
int hours[3][2] = {{8, 5}, {7, 9}, {6, 3}};
```

The same definition could also be written as:

```
int hours[3][2] = {{8, 5},  
                  {7, 9},  
                  {6, 3}};
```

In either case, the values are assigned to hours in the following manner:

```
hours[0][0] is set to 8  
hours[0][1] is set to 5  
hours[1][0] is set to 7  
hours[1][1] is set to 9  
hours[2][0] is set to 6  
hours[2][1] is set to 3
```

**Figure 7-16** illustrates the initialization.

**Figure 7-16 Two-dimensional array initialization**

	Column 0	Column 1
Row 0	8	5
Row 1	7	9
Row 2	6	3

The extra braces that enclose each row's initialization list are optional. Both of the following statements perform the same initialization:

```
int hours[3][2] = {{8, 5}, {7, 9}, {6, 3}};  
int hours[3][2] = {8, 5, 7, 9, 6, 3};
```

Because the extra braces visually separate each row, however, it's a good idea to use them. In addition, the braces give you the ability to leave out initializers within a row without omitting the initializers for the rows that follow it. For instance, look at the following array definition:

```
int table[3][2] = {{1}, {3, 4}, {5}};
```

`table[0][0]` is initialized to 1, `table[1][0]` is initialized to 3, `table[1][1]` is initialized to 4, and `table[2][0]` is initialized to 5. `table[0][1]` and `table[2][1]` are not initialized. Because some of the array elements are initialized, these two initialized elements are automatically set to zero.

# Passing Two-Dimensional Arrays to Functions

**Program 7-22** [📄](#) demonstrates passing a two-dimensional array to a function. When a two-dimensional array is passed to a function, the parameter type must contain a size declarator for the number of columns. Here is the header for the function `showArray`, from **Program 7-22** [📄](#):

```
void showArray(const int numbers[][COLS], int rows)
```

`COLS` is a global named constant that is set to 4. The function can accept any two-dimensional integer array, as long as it consists of four columns. In the program, the contents of two separate arrays are displayed by the function.

## Program 7-22

```
1 // This program demonstrates accepting a 2D array argument.
2 #include <iostream>
3 #include <iomanip>
4 using namespace std;
5
6 // Global constants
7 const int COLS = 4; // Number of columns in each array
8 const int TBL1_ROWS = 3; // Number of rows in table1
9 const int TBL2_ROWS = 4; // Number of rows in table2
10
11 void showArray(const int[][COLS], int); // Function prototype
12
13 int main()
14 {
15     int table1[TBL1_ROWS][COLS] = {{1, 2, 3, 4},
16                                     {5, 6, 7, 8},
17                                     {9, 10, 11, 12}};
18     int table2[TBL2_ROWS][COLS] = {{10, 20, 30, 40},
19                                     {50, 60, 70, 80},
20                                     {90, 100, 110, 120},
21                                     {130, 140, 150, 160}};
22
23     cout << "The contents of table1 are:\n";
24     showArray(table1, TBL1_ROWS);
25     cout << "The contents of table2 are:\n";
26     showArray(table2, TBL2_ROWS);
27     return 0;
28 }
29
30 //*****
31 // Function Definition for showArray *
32 // The first argument is a two-dimensional int array with COLS *
33 // columns. The second argument, rows, specifies the number of *
34 // rows in the array. The function displays the array's contents. *
35 //*****
36
37 void showArray(const int numbers[][COLS], int rows)
```



```

38 {
39     for (int x = 0; x < rows; x++)
40     {
41         for (int y = 0; y < COLS; y++)
42         {
43             cout << setw(4) << numbers[x][y] << " ";
44         }
45         cout << endl;
46     }
47 }

```

### Program Output

```

The contents of table1 are:
 1  2  3  4
 5  6  7  8
 9 10 11 12

The contents of table2 are:
10 20 30 40
50 60 70 80
90 100 110 120
130 140 150 160

```

C++ requires the columns to be specified in the function prototype and header because of the way two-dimensional arrays are stored in memory. One row follows another, as shown in [Figure 7-17](#).

**Figure 7-17 Memory organization of a two-dimensional array**



When the compiler generates code for accessing the elements of a two-dimensional array, it needs to know how many bytes separate the rows in memory. The number of columns is a critical factor in this calculation.

# Summing All the Elements of a Two-Dimensional Array

To sum all the elements of a two-dimensional array, you can use a pair of nested loops to add the contents of each element to an accumulator. The following code is an example:

```
const int NUM_ROWS = 5; // Number of rows
const int NUM_COLS = 5; // Number of columns
int total = 0;          // Accumulator
int numbers[NUM_ROWS][NUM_COLS] = {{2, 7, 9, 6, 4},
                                     {6, 1, 8, 9, 4},
                                     {4, 3, 7, 2, 9},
                                     {9, 9, 0, 3, 1},
                                     {6, 2, 7, 4, 1}};

// Sum the array elements.
for (int row = 0; row < NUM_ROWS; row++)
{
    for (int col = 0; col < NUM_COLS; col++)
        total += numbers[row][col];
}

// Display the sum.
cout << "The total is " << total << endl;
```

# Summing the Rows of a Two-Dimensional Array

Sometimes you may need to calculate the sum of each row in a two-dimensional array. For example, suppose a two-dimensional array is used to hold a set of test scores for a set of students. Each row in the array is a set of test scores for one student. To get the sum of a student's test scores (perhaps so an average may be calculated), you use a loop to add all the elements in one row. The following code shows an example.

```
const int NUM_STUDENTS = 3;      // Number of students
const int NUM_SCORES = 5;      // Number of test scores
double total;                  // Accumulator is set in the loops
double average;                // To hold each student's average
double scores[NUM_STUDENTS][NUM_SCORES] = {{88, 97, 79, 86, 94},
                                             {86, 91, 78, 79, 84},
                                             {82, 73, 77, 82, 89}};
// Get each student's average score.
for (int row = 0; row < NUM_STUDENTS; row++)
{
    // Set the accumulator.
    total = 0;
    // Sum a row.
    for (int col = 0; col < NUM_SCORES; col++)
        total += scores[row][col];
    // Get the average.
    average = total / NUM_SCORES;
    // Display the average.
    cout << "Score average for student "
         << (row + 1) << " is " << average << endl;
}
```

Notice the `total` variable, which is used as an accumulator, is set to zero just before the inner loop executes. This is because the inner loop sums the elements of a row and stores the sum in `total`. Therefore, the `total` variable must be set to zero before each iteration of the inner loop.

# Summing the Columns of a Two-Dimensional Array

Sometimes you may need to calculate the sum of each column in a two-dimensional array. In the previous example, a two-dimensional array is used to hold a set of test scores for a set of students. Suppose you wish to calculate the class average for each of the test scores. To do this, you calculate the average of each column in the array. This is accomplished with a set of nested loops. The outer loop controls the column subscript, and the inner loop controls the row subscript. The inner loop calculates the sum of a column, which is stored in an accumulator. The following code demonstrates this:

```
const int NUM_STUDENTS = 3;    // Number of students
const int NUM_SCORES = 5;     // Number of test scores
double total;                 // Accumulator is set in the loops
double average;              // To hold each score's class average
double scores[NUM_STUDENTS][NUM_SCORES] = {{88, 97, 79, 86, 94},
                                             {86, 91, 78, 79, 84},
                                             {82, 73, 77, 82, 89}};
// Get the class average for each score.
for (int col = 0; col < NUM_SCORES; col++)
{
    // Reset the accumulator.
    total = 0;
    // Sum a column.
    for (int row = 0; row < NUM_STUDENTS; row++)
        total += scores[row][col];
    // Get the average.
    average = total / NUM_STUDENTS;
    // Display the class average.
    cout << "Class average for test " << (col + 1)
          << " is " << average << endl;
}
```

## 7.9 Arrays with Three or More Dimensions


### Concept:

C++ does not limit the number of dimensions that an array may have. It is possible to create arrays with multiple dimensions, to model data that occur in multiple sets.

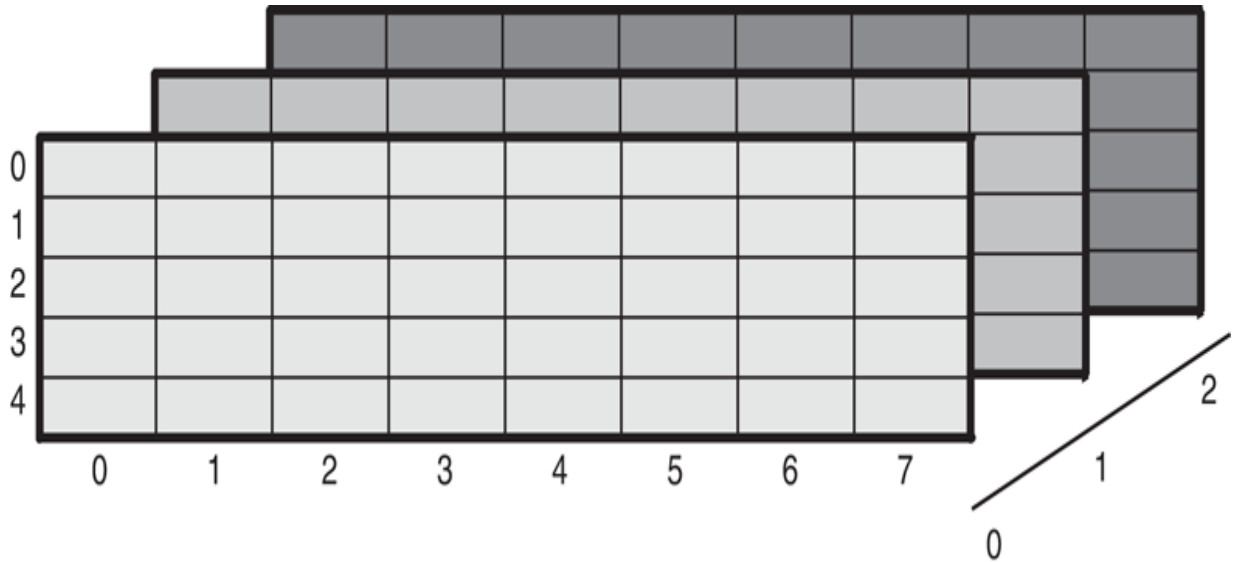
C++ allows you to create arrays with virtually any number of dimensions. Here is an example of a three-dimensional array definition:

```
double seats[3][5][8];
```

This array can be thought of as three sets of five rows, with each row containing eight elements. The array might be used to store the prices of seats in an auditorium, where there are eight seats in a row, five rows in a section, and a total of three sections.

**Figure 7-18**  illustrates the concept of a three-dimensional array as “pages” of two-dimensional arrays.

**Figure 7-18 A three-dimensional array**



Arrays with more than three dimensions are difficult to visualize, but can be useful in some programming problems. For example, in a factory warehouse where cases of widgets are stacked on pallets, an array with four dimensions could be used to store a part number for each widget. The four subscripts of each element could represent the pallet number, case number, row number, and column number of each widget. Similarly, an array with five dimensions could be used if there were multiple warehouses.



**Note:**

When writing functions that accept multi-dimensional arrays as arguments, all but the first dimension must be explicitly stated in the parameter list.

# Checkpoint

7.19 Define a two-dimensional array of `int`s named `grades`. It should have 30 rows and 10 columns.

7.20 How many elements are in the following array?

```
double sales[6][4];
```

7.21

Write a statement that assigns the value 56893.12 to the first column of the first row of the array defined in Question 7.20.

7.22 Write a statement that displays the contents of the last column of the last row of the array defined in Question 7.20.

7.23 Define a two-dimensional array named `settings` large enough to hold the table of data below. Initialize the array with the values in the table.

7.24 Fill in the table below so that it shows the contents of the following array:

```
int table[3][4] = {{2, 3}, {7, 9, 2}, {1}};
```

7.25 Write a function called `displayArray7`. The function should accept a `two`-dimensional array as an argument and display its contents on the screen. The function should work with any of the following arrays:



```
int hours[5][7];  
int stamps[8][7];  
int autos[12][7];  
int cats[50][7];
```

7.26 A video rental store keeps DVDs on 50 racks with 10 shelves each. Each shelf holds 25 DVDs. Define a three-dimensional array large enough to represent the store's storage system.

## 7.10 Focus on Problem Solving and Program Design: A Case Study

The National Commerce Bank has hired you as a contract programmer. Your first assignment is to write a function that will be used by the bank's automated teller machines (ATMs) to validate a customer's personal identification number (PIN).

Your function will be incorporated into a larger program that asks the customer to input his or her PIN on the ATM's numeric keypad. (PINs are seven-digit numbers. The program stores each digit in an element of an integer array.) The program also retrieves a copy of the customer's actual PIN from a database. (The PINs are also stored in the database as 7-element arrays.) If these two numbers match, then the customer's identity is validated. Your function is to compare the two arrays and determine whether they contain the same numbers.

Here are the specifications your function must meet:


Here is the pseudocode for the function:

```
For each element in the first array
    Compare the element with the element in the second array
    that is in the corresponding position.
    If the two elements contain different values
        Return false.
    End If.
End For.
Return true.
```

The C++ code is shown below.

```
bool testPIN(const int custPIN[], const int databasePIN[], int
size)
{
    for (int index = 0; index < size; index++)
    {
        if (custPIN[index] != databasePIN[index])
            return false; // We've found two different values.
    }
    return true; // If we make it this far, the values are the
same.
}
```

Because you have only been asked to write a function that performs the comparison between the customer's input and the PIN that was

retrieved from the database, you will also need to design a driver.  
**Program 7-23**  shows the complete program.

## Program 7-23

```
1 // This program is a driver that tests a
function comparing the
2 // contents of two int arrays.
3 #include <iostream>
4 using namespace std;
5
6 // Function Prototype
7 bool testPIN(const int [], const int [], int);
8
9 int main ()
10 {
11     const int NUM_DIGITS = 7; // Number of
digits in a PIN
12     int pin1[NUM_DIGITS] = {2, 4, 1, 8, 7, 9,
0}; // Base set of values.
13     int pin2[NUM_DIGITS] = {2, 4, 6, 8, 7, 9,
0}; // Only 1 element is
14
// different from pin1.
15     int pin3[NUM_DIGITS] = {1, 2, 3, 4, 5, 6,
7}; // All elements are
16
// different from pin1.
```

```
17     if (testPIN(pin1, pin2, NUM_DIGITS))
18         cout << "ERROR: pin1 and pin2 report to
be the same.\n";
19     else
20         cout << "SUCCESS: pin1 and pin2 are
different.\n";
21
22     if (testPIN(pin1, pin3, NUM_DIGITS))
23         cout << "ERROR: pin1 and pin3 report to
be the same.\n";
24     else
25         cout << "SUCCESS: pin1 and pin3 are
different.\n";
26
27     if (testPIN(pin1, pin1, NUM_DIGITS))
28         cout << "SUCCESS: pin1 and pin1 report
to be the same.\n";
29     else
30         cout << "ERROR: pin1 and pin1 report to
be different.\n";
31     return 0;
32 }
33
34
35 // The following function accepts two int
```

```

arrays. The arrays are *
36 // compared. If they contain the same values,
true is returned. *
37 // If they contain different values, false is
returned. *
38
//*****
*****
39
40 bool testPIN(const int custPIN[], const int
databasePIN[], int size)
41 {
42     for (int index = 0; index < size; index++)
43     {
44         if (custPIN[index] !=
databasePIN[index])
45             return false; // We've found two
different values.
46     }
47     return true; // If we make it this far,
the values are the same.
48 }

```

## Program Output

```
SUCCESS: pin1 and pin2 are different.  
SUCCESS: pin1 and pin3 are different.  
SUCCESS: pin1 and pin1 report to be the  
same.
```

Case Study: See the Intersection of Sets Case Study on the Computer Science Portal at [www.pearsonhighered.com/gaddis](http://www.pearsonhighered.com/gaddis).




## 7.11 Introduction to the STL

### vector

#### Concept:

The Standard Template Library offers a `vector` data type, which in many ways, is superior to standard arrays.

The *Standard Template Library* (STL) is a collection of data types and algorithms that you may use in your programs. These data types and algorithms are *programmer-defined*. They are not part of the C++ language, but were created in addition to the built-in data types. If you plan to continue your studies in the field of computer science, you should become familiar with the STL. This section introduces one of the STL data types. For more information on the STL, see [Chapter 17](#) .

In this section, you will learn to use the `vector` data type. A `vector` is a container that can store data. It is like an array in the following ways:

- A `vector` holds a sequence of values or elements.
- A `vector` stores its elements in contiguous memory locations.
- You can use the array subscript operator `[]` to read the individual elements in the `vector`.

However, a `vector` offers several advantages over arrays. Here are just a few:

- You do not have to declare the number of elements that the `vector` will have.
- If you add a value to a `vector` that is already full, the `vector` will automatically increase its size to accommodate the new value.
- `vector`s can report the number of elements they contain.

# Defining a `vector`

To use `vector`s in your program, you must include the `<vector>` header file with the following statement:

```
#include <vector>
```



## **Note:**

To use the vector data type, you should also have the `using namespace std;` statement in your program.

Now you are ready to define an actual `vector` object. The syntax for defining a `vector` is somewhat different from the syntax used in defining a regular variable or array. Here is an example:

```
vector<int> numbers;
```

This statement defines `numbers` as a `vector` of `int`s. Notice the data type is enclosed in angled brackets, immediately after the word

`vector`. Because the `vector` expands in size as you add values to it, there is no need to declare a size. You can define a starting size, if you prefer. Here is an example:

```
vector<int> numbers(10);
```

This statement defines `numbers` as a `vector` of 10 `int`s. This is only a starting size, however. Although the `vector` has 10 elements, its size will expand if you add more than 10 values to it.



**Note:**

If you specify a starting size for a `vector`, the size declarator is enclosed in parentheses, not in square brackets.

When you specify a starting size for a `vector`, you may also specify an initialization value. The initialization value is copied to each element. Here is an example:

```
vector<int> numbers(10, 2);
```

In this statement, `numbers` is defined as a `vector` of 10 `int`s. Each element in `numbers` is initialized to the value 2.

You may also initialize a `vector` with the values in another `vector`. For example, look at the following statement. Assume `set1` is a `vector` of `int`s that already has values stored in it.

```
vector<int> set2(set1);
```

After this statement executes, `set2` will be a copy of `set1`.

**Table 7-3**  summarizes the `vector` definition procedures we have discussed.

### Table 7-3 `vector` Definitions


# Using an Initialization List with a `vector` in C++ 11

**11** If you are using C++ 11, you can initialize a `vector` with a list of values, as shown in this example:

```
vector<int> numbers { 10, 20, 30, 40 };
```

This statement defines a `vector` of `int`s named `numbers`. The `vector` will have four elements, initialized with the values 10, 20, 30, and 40. Notice the initialization list is enclosed in a set of braces, but you do not use an = operator before the list.

# Storing and Retrieving Values in a `vector`

To store a value in an element that already exists in a `vector`, you may use the array subscript operator `[]`. For example, look at [Program 7-24](#) .

## Program 7-24

```
1 // This program stores, in two vectors, the
hours worked by 5
2 // employees, and their hourly pay rates.
3 #include <iostream>
4 #include <iomanip>
5 #include <vector>
6 using namespace std;
7
8 int main()
9 {
10     const int NUM_EMPLOYEES = 5; //
Number of employees
11     vector<int> hours(NUM_EMPLOYEES); //
A vector of integers
12     vector<double> payRate(NUM_EMPLOYEES); //
A vector of doubles
13     int index; //
Loop counter
14
15     // Input the data.
16     cout << "Enter the hours worked by " <<
NUM_EMPLOYEES;
17     cout << " employees and their hourly
```



```
rates.\n";
18     for (index = 0; index < NUM_EMPLOYEES;
index++)
19     {
20         cout << "Hours worked by employee #"
<< (index + 1);
21         cout << ": ";
22         cin >> hours[index];
23         cout << "Hourly pay rate for employee
#";
24         cout << (index + 1) << ": ";
25         cin >> payRate[index];
26     }
27
28     // Display each employee's gross pay.
29     cout << "\nHere is the gross pay for each
employee:\n";
30     cout << fixed << showpoint <<
setprecision(2);
31     for (index = 0; index < NUM_EMPLOYEES;
index++)
32     {
33         double grossPay = hours[index] *
payRate[index];
34         cout << "Employee #" << (index + 1);
35         cout << ": $" << grossPay << endl;
36     }
```

```
37     return 0;  
38 }
```


**Program Output with Example Input Shown in Bold**

```
Enter the hours worked by 5 employees and
their hourly rates.
```

```
Hours worked by employee #1: 10 Enter
Hourly pay rate for employee #1: 9.75 Enter
Hours worked by employee #2: 15 Enter
Hourly pay rate for employee #2: 8.62 Enter
Hours worked by employee #3: 20 Enter
Hourly pay rate for employee #3: 10.50 Enter
Hours worked by employee #4: 40 Enter
Hourly pay rate for employee #4: 18.75 Enter
Hours worked by employee #5: 40 Enter
Hourly pay rate for employee #5: 15.65 Enter
```

```
Here is the gross pay for each employee:
```

```
Employee #1: $97.50
Employee #2: $129.30
Employee #3: $210.00
Employee #4: $750.00
Employee #5: $626.00
```

Notice **Program 7-24**  uses the following statements in lines 11 and 12 to define two `vector`s:

```
vector<int> hours(NUM_EMPLOYEES); // A vector of integers
vector<double> payRate(NUM_EMPLOYEES); // A vector of doubles
```

Both of the `vector`s are defined with the starting size 5, which is the value of the named constant `NUM_EMPLOYEES`. The program uses the following loop in lines 18 through 26 to store a value in each element of both `vector`s:


```
for (index = 0; index < NUM_EMPLOYEES; index++)
{
    cout << "Hours worked by employee #" << (index + 1);
    cout << ": ";
    cin >> hours[index];
    cout << "Hourly pay rate for employee #";
    cout << (index + 1) << ": ";
    cin >> payRate[index];
}
```

Because the values entered by the user are being stored in `vector` elements that already exist, the program uses the array subscript operator `[]`, as shown in the following statements, which appear in lines 22 and 25:

```
cin >> hours[index];
```

```
cin >> payRate[index];
```

# Using the Range-Based `for` Loop with a `vector` in C++ 11


**11** With C++ 11, you can use a range-based `for` loop to step through the elements of a `vector`, as shown in [Program 7-25](#) .

## Program 7-25

```
1 // This program demonstrates the range-based
for loop with a vector.
2 include <iostream>
3 #include <vector>
4 using namespace std;
5
6 int main()
7 {
8     // Define and initialize a vector.
9     vector<int> numbers { 10, 20, 30, 40, 50
};
10
11     // Display the vector elements.
12     for (int val : numbers)
13         cout << val << endl;
14
15     return 0;
16 }
```

## Program Output

```
10
20
30
40
50
```

**Program 7-26**  shows how you can use a reference variable with the range-based `for` loop to store items in a `vector`.



## Program 7-26

```
1 // This program demonstrates the range-based
for loop with a vector.
2 #include <iostream>
3 #include <vector>
4 using namespace std;
5
6 int main()
7 {
8     // Define a vector.
9     vector<int> numbers(5);
10
11     // Get values for the vector elements.
12     for (int &val : numbers)
13     {
14         cout << "Enter an integer value: ";
15         cin >> val;
16     }
17
18     // Display the vector elements.
19     cout << "Here are the values you
entered:\n";
20     for (int val : numbers)
21         cout << val << endl;
```

```
22
23     return 0;
24 }
```

## Program Output with Example Input Shown in Bold

```
Enter an integer value: 1 Enter
Enter an integer value: 2 Enter
Enter an integer value: 3 Enter
Enter an integer value: 4 Enter
Enter an integer value: 5 Enter
Here are the values you entered:
1
2
3
4
5
```

In line 9, we define `numbers` as a `vector` of `int`s, with five elements. Notice in line 12 the range variable, `val`, has an ampersand (`&`) written in front of its name. This declares `val` as a reference variable. As the loop executes, the `val` variable will be an

alias for a `vector` element. Any changes made to the `val` variable will actually be made to the `vector` element it references.

Also notice in line 20 we did not declare `val` as a reference variable (there is no ampersand written in front of the variable's name).



Because the loop is simply displaying the `vector` elements, and does not need to change the `vector`'s contents, there is no need to make `val` a reference variable.

## Using the `push_back` Member Function

You cannot use the `[]` operator to access a `vector` element that does not exist. To store a value in a `vector` that does not have a starting size, or that is already full, use the `push_back` member function. The `push_back` member function accepts a value as an argument and stores that value after the last element in the `vector`. (It pushes the value onto the back of the `vector`.) Here is an example:

```
numbers.push_back(25);
```

Assuming `numbers` is a `vector` of `int`s, this statement stores 25 as the last element. If `numbers` is full, the statement creates a new last element and stores 25 in it. If there are no elements in `numbers`, this statement creates an element and stores 25 in it.

**Program 7-27**  is a modification of **Program 7-24** . This version, however, allows the user to specify the number of employees. The two `vector`s, `hours` and `payRate`, are defined without starting sizes. Because these `vector`s have no starting elements, the `push_back` member function is used to store values in the `vector`s.

## Program 7-27

```
1 // This program stores, in two arrays, the
hours worked by 5
2 // employees, and their hourly pay rates.
3 #include <iostream>
4 #include <iomanip>
5 #include <vector>
6 using namespace std;
7
8 int main()
9 {
10     vector<int> hours; // hours is an
empty vector
11     vector<double> payRate; // payRate is an
empty vector
12     int numEmployees; // The number of
employees
13     int index; // Loop counter
14
15     // Get the number of employees.
16     cout << "How many employees do you have?
";
17     cin >> numEmployees;
18
```

```
19 // Input the payroll data.
20 cout << "Enter the hours worked by " <<
numEmployees;
21 cout << " employees and their hourly
rates.\n";
22 for (index = 0; index < numEmployees;
index++)
23 {
24     int tempHours; // To hold the
number of hours entered
25     double tempRate; // To hold the
pay rate entered
26
27     cout << "Hours worked by employee #"
<< (index + 1);
28     cout << ": ";
29     cin >> tempHours;
30     hours.push_back(tempHours); //
Add an element to hours
31     cout << "Hourly pay rate for employee
#";
32     cout << (index + 1) << ": ";
33     cin >> tempRate;
34     payRate.push_back(tempRate); // Add an
element to payRate
35 }
36
```

```
37 // Display each employee's gross pay.
38 cout << "Here is the gross pay for each
employee:\n";
39 cout << fixed << showpoint <<
setprecision(2);
40 for (index = 0; index < numEmployees;
index++)
41 {
42     double grossPay = hours[index] *
payRate[index];
43     cout << "Employee #" << (index + 1);
44     cout << ": $" << grossPay << endl;
45 }
46 return 0;
47 }
```

**Program Output with Example Input Shown in Bold**

```
How many employees do you have? 3 Enter
Enter the hours worked by 3 employees and
their hourly rates.
Hours worked by employee #1: 40 Enter
Hourly pay rate for employee #1: 12.63 Enter
Hours worked by employee #2: 25 Enter
Hourly pay rate for employee #2: 10.35 Enter
Hours worked by employee #3: 45 Enter
Hourly pay rate for employee #3: 22.65 Enter

Here is the gross pay for each employee:
Employee #1: $505.20
Employee #2: $258.75
Employee #3: $1019.2
```

Notice in lines 40 through 45, the second loop, which calculates and displays each employee's gross pay, uses the `[]` operator to access the elements of the `hours` and `payRate` vectors.



```
for (index = 0; index < numEmployees; index++)  
{  
    double grossPay = hours[index] * payRate[index];  
    cout << "Employee #" << (index + 1);  
    cout << ": $" << grossPay << endl;  
}
```

This is possible because the first loop in lines 22 through 35 uses the `push_back` member function to create the elements in the two vectors.

# Determining the Size of a `vector`


Unlike arrays, `vector`s can report the number of elements they contain. This is accomplished with the `size` member function. Here is an example of a statement that uses the `size` member function:

```
numValues = set.size();
```

In this statement, assume `numValues` is an `int`, and `set` is a `vector`. After the statement executes, `numValues` will contain the number of elements in `set`.

The `size` member function is especially useful when you are writing functions that accept `vector`s as arguments. For example, look at the following code for the `showValues` function:

```
void showValues(vector<int> vect)
{
    for (int count = 0; count < vect.size(); count++)
        cout << vect[count] << endl;
}
```

Because the `vector` can report its size, this function does not need to accept a second argument indicating the number of elements in the `vector`. **Program 7-28**  demonstrates this function.

## Program 7-28

```
1 // This program demonstrates the vector size
2 // member function.
3 #include <iostream>
4 #include <vector>
5 using namespace std;
6
7 // Function prototype
8 void showValues(vector<int>);
9
10 int main()
11 {
12     vector<int> values;
13
14     // Put a series of numbers in the vector.
15     for (int count = 0; count < 7; count++)
16         values.push_back(count * 2);
17
18     // Display the numbers.
19     showValues(values);
20     return 0;
21 }
22
23
```

```

//*****
**
24 // Definition of function showValues.
*
25 // This function accepts an int vector as its
*
26 // argument. The value of each of the vector's
*
27 // elements is displayed.
*
28
//*****
**
29
30 void showValues(vector<int> vect)
31 {
32     for (int count = 0; count < vect.size();
count++)
33         cout << vect[count] << endl;
34 }
```

## Program Output

0

2

4

6

8

10


12

# Removing Elements from a

`vector`

Use the `pop_back` member function to remove the last element from a `vector`. In the following statement, assume `collection` is the name of a `vector`:

```
collection.pop_back();
```

This statement removes the last element from the `collection` vector. [Program 7-29](#)  demonstrates the function.

## Program 7-29

```
1 // This program demonstrates the vector
pop_back member function.
2 #include <iostream>
3 #include <vector>
4 using namespace std;
5
6 int main()
7 {
8     vector<int> values;
9
10    // Store values in the vector.
11    values.push_back(1);
12    values.push_back(2);
13    values.push_back(3);
14    cout << "The size of values is " <<
values.size() << endl;
15
16    // Remove a value from the vector.
17    cout << "Popping a value from the vector
... \n";
18    values.pop_back();
19    cout << "The size of values is now " <<
values.size() << endl;
```



```
20
21     // Now remove another value from the
vector.
22     cout << "Popping a value from the vector
... \n";
23     values.pop_back();
24     cout << "The size of values is now " <<
values.size() << endl;
25
26     // Remove the last value from the vector.
27     cout << "Popping a value from the vector
... \n";
28     values.pop_back();
29     cout << "The size of values is now " <<
values.size() << endl;
30     return 0;
31 }
```


## Program Output

```
The size of values is 3
Popping a value from the vector...
The size of values is now 2
Popping a value from the vector...
The size of values is now 1
Popping a value from the vector...
The size of values is now 0
```

# Clearing a `vector`

To completely clear the contents of a `vector`, use the `clear` member function, as shown in the following statement:

```
numbers.clear();
```

After this statement executes, `numbers` will be cleared of all its elements. [Program 7-30](#)  demonstrates the function.

## Program 7-30

```
1 // This program demonstrates the vector clear
member function.
2 #include <iostream>
3 #include <vector>
4 using namespace std;
5
6 int main()
7 {
8     vector<int> values(100);
9
10    cout << "The values vector has "
11         << values.size() << " elements.\n";
12    cout << "I will call the clear member
function ... \n";
13    values.clear();
14    cout << "Now, the values vector has "
15         << values.size() << " elements.\n";
16    return 0;
17 }
```

## Program Output

The values vector has 100 elements.  
I will call the clear member function...  
Now, the values vector has 0 elements.

# Detecting an Empty `vector`

To determine if a `vector` is empty, use the `empty` member function. The function returns `true` if the `vector` is empty, and `false` if the `vector` has elements stored in it. Assuming `numberVector` is a `vector`, here is an example of its use:

```
if (numberVector.empty())  
    cout << "No values in numberVector.\n";
```

**Program 7-31** [🔗](#) uses a function named `avgVector`, which demonstrates the `empty` member function.

## Program 7-31

```
1 // This program demonstrates the vector's
empty member function.
2 #include <iostream>
3 #include <vector>
4 using namespace std;
5
6 // Function prototype
7 double avgVector(vector<int>);
8
9 int main()
10 {
11     vector<int> values; // A vector to hold
values
12     int numValues;     // The number of
values
13     double average;   // To hold the
average
14
15     // Get the number of values to average.
16     cout << "How many values do you wish to
average? ";
17     cin >> numValues;
18
```

```

19     // Get the values and store them in the
vector.
20     for (int count = 0; count < numValues;
count++)
21     {
22         int tempValue;
23         cout << "Enter a value: ";
24         cin >> tempValue;
25         values.push_back(tempValue);
26     }
27
28     // Get the average of the values and
display it.
29     average = avgVector(values);
30     cout << "Average: " << average << endl;
31     return 0;
32 }
33
34
//*****
*****
35 // Definition of function avgVector.
*
36 // This function accepts an int vector as its
argument. If *
37 // the vector contains values, the function
returns the *
```



```
38 // average of those values. Otherwise, an
error message is *
39 // displayed and the function returns 0.0.
*
40
//*****
*****
41
42 double avgVector(vector<int> vect)
43 {
44     int total = 0; // accumulator
45     double avg; // average
46
47     if (vect.empty()) // Determine if the
vector is empty
48     {
49         cout << "No values to average.\n";
50         avg = 0.0;
51     }
52     else
53     {
54         for (int count = 0; count <
vect.size(); count++)
55             total += vect[count];
56         avg = total / vect.size();
57     }
```

```
58     return avg;
59 }
```


### Program Output with Example Input Shown in Bold

```
How many values do you wish to average? 5
Enter
Enter a value: 12
Enter a value: 18
Enter a value: 3
Enter a value: 7
Enter a value: 9
Average: 9
```

### Program Output with Different Example Input Shown in Bold

```
How many values do you wish to average? 0
Enter
No values to average.
Average: 0
```

# Summary of `vector` Member Functions

**Table 7-4**  provides a summary of the `vector` member function we have discussed, as well as some additional ones.

**Table 7-4** Some of the `vector` Member Functions

## *Checkpoint*

7.27 What header file must you `#include` in order to define `vector` objects?

7.28 Write a definition statement for a `vector` named `frogs`. `frogs` should be an empty `vector` of `int`s.

7.29 Write a definition statement for a `vector` named `lizards`. `lizards` should be a `vector` of 20 `float`s.

7.30 Write a definition statement for a `vector` named `toads`. `toads` should be a `vector` of 100 `char`s, with each element initialized to `'z'`.

7.31 `gators` is an empty `vector` of `int`s. Write a statement that stores the value 27 in `gators`.

7.32 `snakes` is a `vector` of `double`s, with 10 elements. Write a statement that stores the value 12.897 in element 4 of the `snakes vector`.

# Review Questions and Exercises

## Short Answer

1. What is the difference between a size declarator and a subscript?
2. Look at the following array definition:

```
int values[10];
```

How many elements does the array have?

What is the subscript of the first element in the array?

What is the subscript of the last element in the array?

Assuming that an `int` uses 4 bytes of memory, how much memory does the array use?

3. Why should a function that accepts an array as an argument, and processes that array, also accept an argument specifying the array's size?
4. Consider the following array definition:

```
int values[5] = { 4, 7, 6, 8, 2 };
```

What does each of the following statements display?

```
cout << values[4] << endl; _____
```

```
cout << (values[2] + values[3]) << endl; _____
```

```
cout << ++values[1] << endl; _____
```

5. How do you define an array without providing a size declarator?
6. Look at the following array definition:

```
int numbers[5] = { 1, 2, 3 };
```

What value is stored in `numbers[2]` ?

What value is stored in `numbers[4]` ?

7. Assuming that `array1` and `array2` are both arrays, why is it not possible to assign the contents of `array2` to `array1` with the following statement?

```
array1 = array2;
```

8. Assuming that `numbers` is an array of `double`s, will the following statement display the contents of the array?

```
cout << numbers << endl;
```

9. Is an array passed to a function by value or by reference?

10. When you pass an array name as an argument to a function, what is actually being passed?
11. How do you establish a parallel relationship between two or more arrays?
12. Look at the following array definition:

```
double sales[8][10];
```

How many rows does the array have?

How many columns does the array have?

How many elements does the array have?

Write a statement that stores a number in the last column of the last row in the array.

13. When writing a function that accepts a two-dimensional array as an argument, which size declarator must you provide in the parameter for the array?
14. What advantages does a `vector` offer over an array?

# Fill-in-the-Blank

15. The \_\_\_\_ indicates the number of elements, or values, an array can hold.
16. The size declarator must be a(n) \_\_\_\_ with a value greater than \_\_\_\_.
17. Each element of an array is accessed and indexed by a number known as a(n) \_\_\_\_.
18. Subscript numbering in C++ always starts at \_\_\_\_.
19. The number inside the brackets of an array definition is the \_\_\_\_, but the number inside an array's brackets in an assignment statement, or any other statement that works with the contents of the array, is the \_\_\_\_.
20. C++ has no array \_\_\_\_ checking, which means you can inadvertently store data past the end of an array.
21. Starting values for an array may be specified with a(n) \_\_\_\_ list.
22. If an array is partially initialized, the uninitialized elements will be set to \_\_\_\_.
23. If the size declarator of an array definition is omitted, C++ counts the number of items in the \_\_\_\_ to determine how large the array should be.
24. By using the same \_\_\_\_ for multiple arrays, you can build relationships between the data stored in the arrays.
25. You cannot use the \_\_\_\_ operator to copy data from one array to another in a single statement.

26. Any time the name of an array is used without brackets and a subscript, it is seen as \_\_\_\_\_.
27. To pass an array to a function, pass the \_\_\_\_\_ of the array.
28. A(n) \_\_\_\_\_ array is like several arrays of the same type put together.
29. It's best to think of a two-dimensional array as having \_\_\_\_\_ and \_\_\_\_\_.
30. To define a two-dimensional array, \_\_\_\_\_ size declarators are required.
31. When initializing a two-dimensional array, it helps to enclose each row's initialization list in \_\_\_\_\_.
32. When a two-dimensional array is passed to a function, the \_\_\_\_\_ size must be specified.
33. The \_\_\_\_\_ is a collection of programmer-defined data types and algorithms that you may use in your programs.
34. The two types of containers defined by the STL are \_\_\_\_\_ and \_\_\_\_\_.
35. The `vector` data type is a(n) \_\_\_\_\_ container.
36. To define a `vector` in your program, you must `#include` the \_\_\_\_\_ header file.
37. To store a value in a `vector` that does not have a starting size, or that is already full, use the \_\_\_\_\_ member function.
38. To determine the number of elements in a `vector`, use the \_\_\_\_\_ member function.
39. Use the \_\_\_\_\_ member function to remove the last element from a `vector`.



40. To completely clear the contents of a `vector`, use the \_\_\_\_\_ member function.

# Algorithm Workbench

41. `names` is an integer array with 20 elements. Write a regular `for` loop, as well as a range-based `for` loop that prints each element of the array.
42. The arrays `numberArray1` and `numberArray2` have 100 elements. Write code that copies the values in `numberArray1` to `numberArray2`.
43. In a program, you need to store the identification numbers of ten employees (as `ints`) and their weekly gross pay (as `double s`).
  - A. Define two arrays that may be used in parallel to store the ten employee identification numbers and gross pay amounts.
  - B. Write a loop that uses these arrays to print each employee's identification number and weekly gross pay.
44. Define a two-dimensional array of integers named `grades`. It should have 30 rows and 10 columns.
45. In a program, you need to store the populations of 12 countries.
  - A. Define two arrays that may be used in parallel to store the names of the countries and their populations.
  - B. Write a loop that uses these arrays to print each country's name and its population.

46. The following code totals the values in two arrays:

`numberArray1` and `numberArray2`. Both arrays have 25 elements. Will the code print the correct sum of values for both arrays? Why or why not?

```
int total = 0;           // Accumulator
int count;              // Loop counter
// Calculate and display the total of the first array.
for (count = 0; count < 24; count++)
    total += numberArray1[count];
cout << "The total for numberArray1 is " << total <<
endl;
// Calculate and display the total of the second array.
for (count = 0; count < 24; count++)
    total += numberArray2[count];
cout << "The total for numberArray2 is " << total <<
endl;
```

47. Look at the following array definition:

```
int numberArray[9][11];
```

Write a statement that assigns 145 to the first column of the first row of this array.

Write a statement that assigns 18 to the last column of the last row of this array.

48. `values` is a two-dimensional array of `float`s with 10 rows and 20 columns. Write code that sums all the elements in the array and stores the sum in the variable `total`.
49. An application uses a two-dimensional array defined as follows:

```
int days[29][5];
```

Write code that sums each row in the array and displays the results.

Write code that sums each column in the array and displays the results.

# True or False

50. T F An array's size declarator can be either a literal, a named constant, or a variable.
51. T F To calculate the amount of memory used by an array, multiply the number of elements by the number of bytes each element uses.
52. T F The individual elements of an array are accessed and indexed by unique numbers.
53. T F The first element in an array is accessed by the subscript 1.
54. T F The subscript of the last element in a single-dimensional array is one less than the total number of elements in the array.
55. T F The contents of an array element cannot be displayed with `cout`.
56. T F Subscript numbers may be stored in variables.
57. T F You can write programs that use invalid subscripts for an array.
58. T F Arrays cannot be initialized when they are defined. A loop or other means must be used.
59. T F The values in an initialization list are stored in the array in the order they appear in the list.
60. T F C++ allows you to partially initialize an array.
61. T F If an array is partially initialized, the uninitialized elements will contain "garbage."

62. T F If you leave an element uninitialized, you do not have to leave all the ones that follow it uninitialized.
63. T F If you leave out the size declarator of an array definition, you do not have to include an initialization list.
64. T F The uninitialized elements of a `string` array will automatically be set to the value `"0"`.
65. T F You cannot use the assignment operator to copy one array's contents to another in a single statement.
66. T F When an array name is used without brackets and a subscript, it is seen as the value of the first element in the array.
67. T F To pass an array to a function, pass the name of the array.
68. T F When defining a parameter variable to hold a single-dimensional array argument, you do not have to include the size declarator.
69. T F When an array is passed to a function, the function has access to the original array.
70. T F A two-dimensional array is like several identical arrays put together.
71. T F It's best to think of two-dimensional arrays as having rows and columns.
72. T F The first size declarator (in the declaration of a two-dimensional array) represents the number of columns. The second size definition represents the number of rows.
73. T F Two-dimensional arrays may be passed to functions, but the row size must be specified in the definition of the parameter variable.

74. T F C++ allows you to create arrays with three or more dimensions.
75. T F A `vector` is an associative container.
76. T F To use a `vector`, you must include the `vector` header file.
77. T F `vector`s can report the number of elements they contain.
78. T F You can use the `[]` operator to insert a value into a `vector` that has no elements.
79. T F If you add a value to a `vector` that is already full, the `vector` will automatically increase its size to accommodate the new value.

# Find the Errors

Each of the following definitions and program segments has errors. Locate as many as you can.

80. 

```
int size;  
double values[size];
```

81. 

```
int collection[220];
```

82. 

```
int table[10];  
for (int x = 0; x < 20; x++)  
{  
    cout << "Enter the next value: ";  
    cin >> table[x];  
}
```

83. 

```
int hours[3] = 8, 12, 16;
```



84. `int numbers[8] = {1, 2, , 4, , 5};`

85. `float ratings[];`

86. `char greeting[] = {'H', 'e', 'l', 'l', 'o'};`  
`cout << greeting;`

87. `int array1[4], array2[4] = {3, 6, 9, 12};`  
`array1 = array2;`

88. `void showValues(int nums)`  
`{`  
 `for (int count = 0; count < 8; count++)`  
 `cout << nums[count];`  
`}`

89.

```
void showValues(int nums[4][])  
{  
    for (rows = 0; rows < 4; rows++)  
        for (cols = 0; cols < 5; cols++)  
            cout << nums[rows][cols];  
}
```

90.

```
vector<int> numbers = { 1, 2, 3, 4 };
```

# Programming Challenges

## 1. Largest/Smallest Array Values

Write a program that lets the user enter ten values into an array. The program should then display the largest and smallest values stored in the array.

## 2. Rainfall Statistics

Write a program that lets the user enter the total rainfall for each of 12 months into an array of `double`s. The program should calculate and display the total rainfall for the year, the average monthly rainfall, and the months with the highest and lowest amounts.

Input Validation: Do not accept negative numbers for monthly rainfall figures.

## 3. Chips and Salsa

Write a program that lets a maker of chips and salsa keep track of sales for five different types of salsa: mild, medium, sweet, hot, and zesty. The program should use two parallel 5-element arrays: an array of strings that holds the five salsa names, and an array of integers that holds the number of jars sold during the past month for each salsa type. The salsa names should be stored using an initialization list at the time the name array is created. The program should prompt the user to enter the number of jars sold for each type. Once this sales data has been entered, the program should produce a report that displays sales for each salsa type, total sales, and the names of the highest selling and lowest selling products.



### Solving the Chips and Salsa Problem

Input Validation: Do not accept negative values for number of jars sold.

## 4. Larger than $n$

In a program, write a function that accepts three arguments: an array, the size of the array, and a number  $n$ . Assume the array contains integers. The function should display all of the numbers in the array that are greater than the number  $n$ .

## 5. Monkey Business

A local zoo wants to keep track of how many pounds of food each of its three monkeys eats each day during a typical week. Write a program that stores this information in a two-dimensional  $3 \times 5$  array, where each row represents a different monkey, and each column represents a different day of the week. The program should first have the user input the data for each monkey. Then, it should create a report that includes the following information:

- Average amount of food eaten per day by the whole family of monkeys.
- The least amount of food eaten during the week by any one monkey.
- The greatest amount of food eaten during the week by any one monkey.

Input Validation: Do not accept negative numbers for pounds of food eaten.

## 6. Rain or Shine

An amateur meteorologist wants to keep track of weather conditions during the past year's three-month summer season, and has designated each day as either rainy ('R'), cloudy ('C'), or sunny ('S'). Write a program that stores this information in a  $3 \times 30$  array of characters, where the row indicates the month (0 = June, 1 = July, 2 = August) and the column indicates the day of the month. Note data are not being collected for the 31st of any month. The program should begin by reading the weather data in from a file. Then it should create a report that displays, for each month and for the whole three-month period, how many days were rainy, how many were cloudy, and how many were sunny. It should also report which of the three months had the largest number of rainy days. Data for the program can be found in the RainOrShine.txt file.

## 7. Number Analysis Program

Write a program that asks the user for a file name. Assume the file contains a series of numbers, each written on a separate line. The program should read the contents of the file into an array then display the following data:

- The lowest number in the array
- The highest number in the array
- The total of the numbers in the array
- The average of the numbers in the array

If you have downloaded this book's source code, you will find a file named numbers.txt in the [Chapter 07](#) folder. You can use the file to test the program.

## 8. Lo Shu Magic Square

The Lo Shu Magic Square is a grid with 3 rows and 3 columns shown in [Figure 7-19](#). The Lo Shu Magic Square has the following properties:

**Figure 7-19 Lo Shu Magic Square**

4	9	2
3	5	7
8	1	6

- The grid contains the numbers 1 through 9 exactly.
- The sum of each row, each column, and each diagonal all add up to the same number. This is shown in [Figure 7-20](#).

Figure 7-20 Sums of the rows, columns, and diagonals

4	9	2	↗ 15
3	5	7	→ 15
8	1	6	→ 15
↓ 15	↓ 15	↓ 15	↘ 15

In a program, you can simulate a magic square using a two-dimensional array. Write a function that accepts a two-dimensional array as an argument, and determines whether the array is a Lo Shu Magic Square. Test the function in a program.

## 9. Payroll

Write a program that uses the following arrays:

- `empId`: an array of seven long integers to hold employee identification numbers. The array should be initialized with the following numbers:

```
5658845 4520125 7895122 8777541
8451277 1302850 7580489
```

- `hours`: an array of seven integers to hold the number of hours worked by each employee
- `payRate`: an array of seven `double`s to hold each employee's hourly pay rate
- `wages`: an array of seven `double`s to hold each employee's gross wages

The program should relate the data in each array through the subscripts. For example, the number in element 0 of the `hours` array should be the number of hours worked by the employee whose identification number is stored in element 0 of the `empId` array. That same employee's pay rate should be stored in element 0 of the `payRate` array.

The program should display each employee number and ask the user to enter that employee's hours and pay rate. It should then calculate the gross wages for that employee (hours times pay rate) and store them in the `wages` array. After the data has been entered for all the employees, the program should display each employee's identification number and gross wages.

Input Validation: Do not accept negative values for hours or numbers less than 15.00 for pay rate.

## 10. Driver's License Exam

The local Driver's License Office has asked you to write a program that grades the written portion of the driver's license exam. The exam has 20 multiple-choice questions. Here are the correct answers:

Your program should store the correct answers shown above in an array. It should ask the user to enter the student's answers for each of the 20 questions, and the answers should be stored in

another array. After the student's answers have been entered, the program should display a message indicating whether the student passed or failed the exam. (A student must correctly answer 15 of the 20 questions to pass the exam.) It should then display the total number of correctly answered questions, the total number of incorrectly answered questions, and a list showing the question numbers of the incorrectly answered questions.

Input Validation: Only accept the letters A, B, C, or D as answers.

### 11. Exam Grader

One of your professors has asked you to write a program to grade her final exams, which consist of only 20 multiple-choice questions. Each question has one of four possible answers: A, B, C, or D. The file `CorrectAnswers.txt` contains the correct answers for all of the questions, with each answer written on a separate line. The first line contains the answer to the first question, the second line contains the answer to the second question, and so forth. (Download the book's source code from the Computer Science Portal at [www.pearsonhighered.com/gaddis](http://www.pearsonhighered.com/gaddis). You will find the file in the [Chapter 07](#) folder.)

Write a program that reads the contents of the `CorrectAnswers.txt` file into a `char` array, then reads the contents of another file, containing a student's answers, into a second `char` array. (You can use the file `StudentAnswers.txt` for testing purposes. This file is also in the [Chapter 07](#) source code folder.) The program should determine the number of questions that the student missed, then display the following:

- A list of the questions missed by the student, showing the correct answer and the incorrect answer provided by the student for each missed question
- The total number of questions missed
- The percentage of questions answered correctly. This can be calculated as

*Correctly Answered Questions ÷ Total Number of Questions*

- If the percentage of correctly answered questions is 70 percent or greater, the program should indicate that the student passed the exam. Otherwise, it should indicate that the student failed the exam.

### 12. Grade Book

A teacher has five students who have taken four tests. The teacher uses the following grading scale to assign a letter grade to a student, based on the average of his or her four test scores: Write a program that uses an array of `string` objects to hold the five student names, an array of five characters to hold the five students' letter grades, and five arrays of four `double`s to hold each student's set of test scores.

The program should allow the user to enter each student's name and his or her four test scores. It should then calculate and display each student's average test score, and a letter grade based on the average.

Input Validation: Do not accept test scores less than 0 or greater than 100.

### 13. Grade Book Modification

Modify the grade book application in Programming Challenge 12 so it drops each student's lowest score when determining the test score averages and letter grades.

### 14. Lottery Application

Write a program that simulates a lottery. The program should have an array of five integers named `lottery` and should generate a random number in the range of 0 through 9 for each element in the array. The user should enter five digits, which should be stored in an integer array named `user`. The program is to compare the corresponding elements in the two arrays and keep a count of the digits that match. For example, the following shows the `lottery` array and the `user` array with sample numbers stored in each. There are two matching digits (elements 2 and 4).

Lottery array:

User array:

The program should display the random numbers stored in the `lottery` array and the number of matching digits. If all of the digits match, display a message proclaiming the user as a grand prize winner.

#### 15. `vector` Modification

Modify the National Commerce Bank case study presented in [Program 7-23](#) so `pin1`, `pin2`, and `pin3` are `vector`s instead of arrays. You must also modify the `testPIN` function to accept a `vector` instead of an array.

#### 16. World Series Champions

If you have downloaded this book's source code, you will find the following files in this chapter's folder:

- `Teams.txt`—This file contains a list of several Major League baseball teams in alphabetical order. Each team listed in the file has won the World Series at least once.
- `WorldSeriesWinners.txt`—This file contains a chronological list of the World Series' winning teams from 1903 to 2012. (The first line in the file is the name of the team that won in 1903, and the last line is the name of the team that won in 2012. Note the World Series was not played in 1904 or 1994.)

Write a program that displays the contents of the `Teams.txt` file on the screen and prompts the user to enter the name of one of the teams. The program should then display the number of times that team has won the World Series in the time period from 1903 to 2012.

#### Tip:

Read the contents of the `WorldSeriesWinners.txt` file into an array or `vector`. When the user enters the name of a team, the program should step through the array or `vector` counting the number of times the selected team appears.

#### 17. Name Search

If you have downloaded this book's source code, you will find the following files in this chapter's folder:

- GirlNames.txt—This file contains a list of the 200 most popular names given to girls born in the United States from 2000 to 2009.
- BoyNames.txt—This file contains a list of the 200 most popular names given to boys born in the United States from 2000 to 2009.

Write a program that reads the contents of the two files into two separate arrays or `vector`s. The user should be able to enter a boy's name, a girl's name, or both, and the application should display messages indicating whether the names were among the most popular.

### 18. Tic-Tac-Toe Game

Write a program that allows two players to play a game of tic-tac-toe. Use a two-dimensional `char` array with three rows and three columns as the game board. Each element of the array should be initialized with an asterisk (\*). The program should run a loop that does the following:

- Displays the contents of the board array.
- Allows player 1 to select a location on the board for an X. The program should ask the user to enter the row and column numbers.
- Allows player 2 to select a location on the board for an O. The program should ask the user to enter the row and column numbers.
- Determines whether a player has won, or a tie has occurred. If a player has won, the program should declare that player the winner and end. If a tie has occurred, the program should display an appropriate message and end.

Player 1 wins when there are three Xs in a row on the game board. The Xs can appear in a row, in a column, or diagonally across the board. Player 2 wins when there are three Os in a row on the game board. The Os can appear in a row, in a column, or diagonally across the board. A tie occurs when all of the locations on the board are full, but there is no winner.

### 19. Magic 8 Ball

Write a program that simulates a Magic 8 Ball, which is a fortune-telling toy that displays a random response to a yes or no question. In the student sample programs for this book, you will find a text file named `8_ball_responses.txt`. The file contains 12 responses, such as "I don't think so", "Yes, of course!", "I'm not sure", and so forth. The program should read the responses from the file into an array or `vector`. It should prompt the user to ask a question, and then display one of the responses, randomly selected from the array or `vector`. The program should repeat until the user is ready to quit.



## Contents of 8\_ball\_responses.txt:

```
Yes, of course!  
Without a doubt, yes.  
You can count on it.  
For sure!  
Ask me later.  
I'm not sure.  
I can't tell you right now.  
I'll tell you after my nap.  
No way!  
I don't think so.  
Without a doubt, no.  
The answer is clearly NO.
```

### 20. 1994 Gas Prices

In the student sample programs for this book, you will find a text file named `1994_Weekly_Gas_Averages.txt`. The file contains the average gas price for each week in the year 1994 (There are 52 lines in the file. Line 1 contains the average price for week 1, line 2 contains the average price for week 2, and so forth.) Write a program that reads the gas prices from the file into an array or a `vector`. The program should do the following:

- Display the lowest average price of the year, along with the week number for that price, and the name of the month in which it occurred.
- Display the highest average price of the year, along with the week number for that price, and the name of the month in which it occurred.
- Display the average gas price for each month. (To get the average price for a given month, calculate the average of the average weekly prices for that month.)

### 21. 2D Array Operations

Write a program that creates a two-dimensional array initialized with test data. Use any data type you wish. The program should have the following functions:

- `getTotal`—This function should accept a two-dimensional array as its argument and return the total of all the values in the array.
- `getAverage`—This function should accept a two-dimensional array as its argument and return the average of all the values in the array.
- `getRowTotal`—This function should accept a two-dimensional array as its first argument and an integer as its second argument. The second argument should be the subscript of a row in

the array. The function should return the total of the values in the specified row.

- `getColumnTotal`—This function should accept a two-dimensional array as its first argument and an integer as its second argument. The second argument should be the subscript of a column in the array. The function should return the total of the values in the specified column.
- `getHighestInRow`—This function should accept a two-dimensional array as its first argument and an integer as its second argument. The second argument should be the subscript of a row in the array. The function should return the highest value in the specified row of the array.
- `getLowestInRow`—This function should accept a two-dimensional array as its first argument and an integer as its second argument. The second argument should be the subscript of a row in the array. The function should return the lowest value in the specified row of the array.

Demonstrate each of the functions in this program.

# Group Project

## 22. Theater Seating

This program should be designed and written by a team of students. Here are some suggestions:

- One student should design function `main`, which will call the other functions in the program. The remainder of the functions will be designed by other members of the team.
- The requirements of the program should be analyzed so that each student is given about the same workload.
- The parameters and return types of each function should be decided in advance.
- The program can be implemented as a multi-file program, or all the functions can be cut and pasted into the main file.

Here is the assignment: Write a program that can be used by a small theater to sell tickets for performances. The theater's auditorium has 15 rows of seats, with 30 seats in each row. The program should display a screen that shows which seats are available and which are taken. For example, the following screen shows a chart depicting each seat in the theater. Seats that are taken are represented by an `*` symbol, and seats that are available are represented by a `#` symbol.

```

                Seats
    123456789012345678901234567890
Row 1  ***###**#####*#####*#####
Row 2  ####*****#####*#####
Row 3  **###*****#####*#####
Row 4  *#####*#####*#####
Row 5  *****#####*#####
Row 6  #####*#####*#####
Row 7  #####*#####*#####
Row 8  ******#####*#####
Row 9  #####*#####*#####
Row 10 #####*#####*#####
Row 11 *#####*#####*#####
Row 12 #####*#####*#####
Row 13 ###*****#####*#####
Row 14 #####*#####*#####
Row 15 #####*#####*#####

```

Here is a list of tasks this program must perform:

- When the program begins, it should ask the user to enter the seat prices for each row. The prices can be stored in a separate array. (Alternatively, the prices may be read from a file.)
- Once the prices are entered, the program should display a seating chart similar to the one shown above. The user may enter the row and seat numbers for tickets being sold.

Every time a ticket or group of tickets is purchased, the program should display the total ticket prices and update the seating chart.

- The program should keep a total of all ticket sales. The user should be given an option of viewing this amount.
- The program should also give the user an option to see a list of how many seats have been sold, how many seats are available in each row, and how many seats are available in the entire auditorium.

Input Validation: When tickets are being sold, do not accept row or seat numbers that do not exist. When someone requests a particular seat, the program should make sure that seat is available before it is sold.

---

# Chapter 8 Searching and Sorting Arrays

---

## Topics

8.1 Focus on Software Engineering: Introduction to Search Algorithms [📄](#)

8.2 Focus on Problem Solving and Program Design: A Case Study [📄](#)

8.3 Focus on Software Engineering: Introduction to Sorting Algorithms [📄](#)

8.4 Focus on Problem Solving and Program Design: A Case Study [📄](#)

8.5 Sorting and Searching `vectors` [📄](#)

# 8.1 Focus on Software Engineering: Introduction to Search Algorithms

**Concept:**

A search algorithm is a method of locating a specific item in a larger collection of data. This section discusses two algorithms for searching the contents of an array.

It's very common for programs not only to store and process data stored in arrays, but also to search arrays for specific items. This section will show you two methods of searching an array: the linear search and the binary search. Each has its advantages and disadvantages.

# The Linear Search

The *linear search* is a very simple algorithm. Also known as the *sequential search* algorithm, it uses a loop to sequentially step through an array, starting with the first element. It compares each element with the value being searched for, and stops when either the value is found or the end of the array is encountered. If the value being searched for is not in the array, the algorithm will unsuccessfully search to the end of the array.

Here is the pseudocode for a function that performs the linear search:

```
Set found to false
Set position to -1
Set index to 0
While found is false and index < number of elements
  If list[index] is equal to search value
    found = true
    position = index
  End If
  Add 1 to index
End While
Return position
```




The `linearSearch` function shown below is an example of C++ code used to perform a linear search on an integer array. The array `arr`, which has a maximum of `size` elements, is searched for an occurrence of the number stored in `value`. If the number is found, its array subscript is returned. Otherwise, `-1` is returned, indicating the value did not appear in the array.

```
int linearSearch (const int arr[], int size, int value)
{
    int index = 0;        // Used as a subscript to search the
    array
    int position = -1;    // To record the position of the search
    value
    bool found = false;  // Flag to indicate if the value was
    found
    while (index < size && !found)
    {
        if (arr[index] == value) // If the value is found
        {
            found = true;        // Set the flag
            position = index;     // Record the value's subscript
        }
        index++;                // Go to the next element
    }
    return position;          // Return the position, or -1
}
```



### **Note:**

The reason `-1` is returned when the search value is not found in the array is because `-1` is not a valid subscript.

**Program 8-1**  is a complete program that uses the `linearSearch` function. It searches the five-element array `tests` to find a score of 100.

## Program 8-1

```
1 // This program demonstrates the linear search
algorithm.
2 #include <iostream>
3 using namespace std;
4
5 // Function prototype
6 int linearSearch(const int[], int, int);
7
8 int main()
9 {
10     const int SIZE = 5;
11     int tests[SIZE] = { 87, 75, 98, 100, 82 };
12     int results;
13
14     // Search the array for 100.
15     results = linearSearch(tests, SIZE, 100);
16
17     // If linearSearch returned -1, then 100
was not found.
18     if (results == -1)
19         cout << "You did not earn 100 points on
any test\n";
20     else
```

```

21     {
22         // Otherwise results contains the
subscript of
23         // the first 100 in the array.
24         cout << "You earned 100 points on test
";
25         cout << (results + 1) << endl;
26     }
27     return 0;
28 }
29
30
//*****
*****
31 // The linearSearch function performs a linear
search on an *
32 // integer array. The array arr, which has a
maximum of size *
33 // elements, is searched for the number stored
in value. If the *
34 // number is found, its array subscript is
returned. Otherwise, *
35 // -1 is returned indicating the value was not
in the array. *
36
//*****
*****

```

```
37 int linearSearch(const int arr[], int size,  
int value)  
38 {  
39     int index = 0;        // Used as a subscript  
to search array  
40     int position = -1;    // To record position  
of search value  
41     bool found = false;  // Flag to indicate if  
the value was found  
42  
43     while (index < size && !found)  
44     {  
45         if (arr[index] == value) // If the  
value is found  
46         {  
47             found = true;        // Set the  
flag  
48             position = index;    // Record the  
value's subscript  
49         }  
50         index++;                // Go to the  
next element  
51     }  
52     return position;           // Return the  
position, or -1  
53 }
```

## Program Output

```
You earned 100 points on test 4
```

# Inefficiency of the Linear Search

The advantage of the linear search is its simplicity. It is very easy to understand and implement. Furthermore, it doesn't require the data in the array to be stored in any particular order. Its disadvantage, however, is its inefficiency. If the array being searched contains 20,000 elements, the algorithm will have to look at all 20,000 elements in order to find a value stored in the last element (so the algorithm actually reads an element of the array 20,000 times).

In an average case, an item is just as likely to be found near the beginning of the array as near the end. Typically, for an array of  $N$  items, the linear search will locate an item in  $N/2$  attempts. If an array has 50,000 elements, the linear search will make a comparison with 25,000 of them in a typical case. This is assuming, of course, that the search item is consistently found in the array. ( $N/2$  is the average number of comparisons. The maximum number of comparisons is always  $N$ .)

When the linear search fails to locate an item, it must make a comparison with every element in the array. As the number of failed search attempts increases, so does the average number of comparisons. Obviously, the linear search should not be used on large arrays if the speed is important.

# The Binary Search

The *binary search* is a clever algorithm that is much more efficient than the linear search. Its only requirement is that the values in the array be sorted in order. Instead of testing the array's first element, this algorithm starts with the element in the middle. If that element happens to contain the desired value, then the search is over. Otherwise, the value in the middle element is either greater than or less than the value being searched for. If it is greater, then the desired value (if it is in the list) will be found somewhere in the first half of the array. If it is less, then the desired value (again, if it is in the list) will be found somewhere in the last half of the array. In either case, half of the array's elements have been eliminated from further searching.



## The Binary Search

If the desired value wasn't found in the middle element, the procedure is repeated for the half of the array that potentially contains the value. For instance, if the last half of the array is to be



searched, the algorithm immediately tests *its* middle element. If the desired value isn't found there, the search is narrowed to the quarter of the array that resides before or after that element. This process continues until either the value being searched for is found, or there are no more elements to test.

Here is the pseudocode for a function that performs a binary search on an array:

```
Set first to 0
Set last to the last subscript in the array
Set found to false
Set position to -1
While found is not true and first is less than or equal to last
    Set middle to the subscript halfway between array[first]
    and array[last]
    If array[middle] equals the desired value
        Set found to true
        Set position to middle
    Else If array[middle] is greater than the desired value
        Set last to middle - 1
    Else
        Set first to middle + 1
    End If
End While
Return position
```

This algorithm uses three index variables: `first`, `last`, and `middle`. The `first` and `last` variables mark the boundaries of the portion of the array currently being searched. They are initialized with the subscripts of the array's first and last elements. The subscript of the element halfway between `first` and `last` is calculated and stored in the `middle` variable. If the element in the middle of the array does not contain the search value, the `first` or `last` variables are adjusted so only the top or bottom half of the array is searched during the next iteration. This cuts the portion of the array being searched in half each time the loop fails to locate the search value.


The function `binarySearch` shown in the following example is used to perform a binary search on an integer array. The first parameter, `array`, which has a maximum of `numElems` elements, is searched for an occurrence of the number stored in `value`. If the number is found, its array subscript is returned. Otherwise, `-1` is returned indicating the value did not appear in the array.

```

int binarySearch(const int array[], int numElems, int value)
{
    int first = 0, // First array
    element
    last = numElems - 1, // Last array
    element
    middle, // Midpoint of
    search
    position = -1; // Position of
    search value
    bool found = false; // Flag
    while (!found && first <= last)
    {
        middle = (first + last) / 2; // Calculate
        midpoint
        if (array[middle] == value) // If value is found
        at mid
        {
            found = true;
            position = middle;
        }
        else if (array[middle] > value) // If value is in
        lower half
        last = middle - 1;
        else
        first = middle + 1; // If value is in
        upper half
    }
}

```

```
}  
    return position;  
}
```

**Program 8-2**  is a complete program using the `binarySearch` function. It searches an array of employee ID numbers for a specific value.

## Program 8-2

```
1 // This program demonstrates the binarySearch
function, which
2 // performs a binary search on an integer
array.
3 #include <iostream>
4 using namespace std;
5
6 // Function prototype
7 int binarySearch(const int [], int, int);
8 const int SIZE = 20;
9
10 int main()
11 {
12     // Array with employee IDs sorted in
ascending order.
13     int idNums[SIZE] = {101, 142, 147, 189,
199, 207, 222,
14                          234, 289, 296, 310, 319,
388, 394,
15                          417, 429, 447, 521, 536,
600};
16     int results; // To hold the search
results
```

```
17     int empID;    // To hold an employee ID
18
19     // Get an employee ID to search for.
20     cout << "Enter the employee ID you wish to
search for: ";
21     cin >> empID;
22
23     // Search for the ID.
24     results = binarySearch(idNums, SIZE,
empID);
25
26     // If results contains -1 the ID was not
found.
27     if (results == -1)
28         cout << "That number does not exist in
the array. \n";
29     else
30     {
31         // Otherwise results contains the
subscript of
32         // the specified employee ID in the
array.
33         cout << "That ID is found at element
" << results;
34         cout << " in the array.\n";
35     }
36     return 0;
```

```

37 }
38
39
//*****
*****
40 // The binarySearch function performs a binary
search on an *
41 // integer array. array, which has a maximum
of size elements, *
42 // is searched for the number stored in value.
If the number is *
43 // found, its array subscript is returned.
Otherwise, -1 is *
44 // returned indicating the value was not in
the array. *
45
//*****
*****
46
47 int binarySearch(const int array[], int size,
int value)
48 {
49     int first = 0, // First array
element
50     last = size - 1, // Last array
element
51     middle, // Midpoint of search

```

```
52         position = -1;    // Position of
search value
53         bool found = false; // Flag
54
55         while (!found && first <= last)
56         {
57             middle = (first + last) / 2; //
Calculate midpoint
58             if (array[middle] == value) // If
value is found at mid
59             {
60                 found = true;
61                 position = middle;
62             }
63             else if (array[middle] > value) // If
value is in lower half
64                 last = middle - 1;
65             else
66                 first = middle + 1; // If value is
in upper half
67         }
68         return position;
69     }
```

**Program Output with Example Input Shown in Bold**



```
Enter the employee ID you wish to search
for: 199 Enter
That ID is found at element 4 in the array.
```



### ***Warning!***


Notice the array in [Program 8-2](#) is initialized with its values already sorted in ascending order. The binary search algorithm will not work properly unless the values in the array are sorted.

# The Efficiency of the Binary Search

Obviously, the binary search is much more efficient than the linear search. Every time it makes a comparison and fails to find the desired item, it eliminates half of the remaining portion of the array that must be searched. For example, consider an array with 1,000 elements. If the binary search fails to find an item on the first attempt, the number of elements that remains to be searched is 500. If the item is not found on the second attempt, the number of elements that remains to be searched is 250. This process continues until the binary search has either located the desired item or determined that it is not in the array. With 1,000 elements, this takes no more than 10 comparisons. (Compare this to the linear search, which would make an average of 500 comparisons!)

Powers of 2 are used to calculate the maximum number of comparisons the binary search will make on an array of any size. (A power of 2 is 2 raised to the power of some number.) Simply find the smallest power of 2 that is greater than or equal to the number of elements in the array. For example, a maximum of 16 comparisons will be made on an array of 50,000 elements ( $2^{16} = 65,536$ ), and a maximum of 20 comparisons will be made on an array of 1,000,000 elements ( $2^{20} = 1,048,576$ ).

## 8.2 Focus on Problem Solving and Program Design: A Case Study

The Demetris Leadership Center (DLC, Inc.) publishes the books, DVDs, and audio CDs listed in [Table 8-1](#) .

### Table 8-1 Products


The manager of the Telemarketing Group has asked you to write a program that will help order-entry operators look up product prices. The program should prompt the user to enter a product number, and will then display the title, description, and price of the product.

## Variables

[Table 8-2](#)  lists the variables needed:

### Table 8-2 Variables

# Modules

The program will consist of the functions listed in [Table 8-3](#) .

## Table 8-3 Functions

# Function `main`

Function `main` contains the variable definitions and calls the other functions. Here is its pseudocode:

```
do
    Call getProdNum
    Call binarySearch
    If binarySearch returned -1
        Inform the user that the product number was not found
    else
        Call displayProd
    End If
    Ask the user if the program should repeat
While the user wants to repeat the program
```

Here is its actual C++ code:

```

do
{
    // Get the desired product number.
    prodNum = getProdNum();
    // Search for the product number.
    index = binarySearch(id, NUM_PRODS, prodNum);
    // Display the results of the search.
    if (index == -1)
        cout << "That product number was not found.\n";
    else
        displayProd(title, description, prices, index);
    // Does the user want to do this again?
    cout << "Would you like to look up another product? (y/n) ";
    cin >> again;
} while (again == 'y' || again == 'Y');

```

The named constant `NUM_PRODS` is defined globally and initialized with the value 9. The arrays `id`, `title`, `description`, and `prices` will already be initialized with data.

# The `getProdNum` Function

The `getProdNum` function prompts the user to enter a product number. It tests the value to ensure it is in the range of 914–922 (which are the valid product numbers). If an invalid value is entered, it is rejected and the user is prompted again. When a valid product number is entered, the function returns it. The pseudocode is shown below.

```
Display a prompt to enter a product number  
Read prodNum  
While prodNum is invalid  
    Display an error message  
    Read prodNum  
End While  
Return prodNum
```

Here is the actual C++ code:

```
int getProdNum()
{
    int prodNum;

    cout << "Enter the item's product number: ";

    cin >> prodNum;

    // Validate input.
    while (prodNum < MIN_PRODNUM || prodNum > MAX_PRODNUM)
    {
        cout << "Enter a number in the range of " << MIN_PRODNUM;
        cout << " through " << MAX_PRODNUM << ".\n";
        cin >> prodNum;
    }

    return prodNum;
}
```

## The `binarySearch` Function

The `binarySearch` function is identical to the function discussed earlier in this chapter.




# The `displayProd` Function

The `displayProd` function has parameter variables named `title`, `desc`, `price`, and `index`. These accept as arguments (respectively) the `title`, `description`, and `price` arrays, and a subscript value. The function displays the data stored in each array at the subscript passed into `index`. Here is the C++ code:

```
void displayProd(const string title[], const string desc[],
                const double price[], int index)
{
    cout << "Title: " << title[index] << endl;
    cout << "Description: " << desc[index] << endl;
    cout << "Price: $" << price[index] << endl;
}
```

# The Entire Program

**Program 8-3**  shows the entire program's source code.

## Program 8-3

```
1 // Demetris Leadership Center (DLC) product
lookup program
2 // This program allows the user to enter a
product number
3 // and then displays the title, description,
and price of
4 // that product.
5 #include <iostream>
6 #include <string>
7 using namespace std;
8
9 const int NUM_PRODS = 9; // The number
of products produced
10 const int MIN_PRODNUM = 914; // The lowest
product number
11 const int MAX_PRODNUM = 922; // The highest
product number
12
13 // Function prototypes
14 int getProdNum();
15 int binarySearch(const int [], int, int);
16 void displayProd(const string [], const
string [], const double [], int);
```

```
17
18 int main()
19 {
20     // Array of product IDs
21     int id[NUM_PRODS] = {914, 915, 916, 917,
22     918, 919, 920,
23     921, 922};
24
25     // Array of product titles
26     string title[NUM_PRODS] =
27     { "Six Steps to Leadership",
28     "Six Steps to Leadership",
29     "The Road to Excellence",
30     "Seven Lessons of Quality",
31     "Seven Lessons of Quality",
32     "Seven Lessons of Quality",
33     "Teams Are Made, Not Born",
34     "Leadership for the Future",
35     "Leadership for the Future"
36     };
37
38     // Array of product descriptions
39     string description[NUM_PRODS] =
40     { "Book", "Audio CD", "DVD",
41     "Book", "Audio CD", "DVD",
42     "Book", "Book", "Audio CD"
43     };
```

```
43
44     // Array of product prices
45     double prices[NUM_PRODS] = {12.95, 14.95,
18.95, 16.95, 21.95,
46                                     31.95, 14.95,
14.95, 16.95};
47
48     int prodNum;    // To hold a product
number
49     int index;     // To hold search results
50     char again;    // To hold a Y or N
answer
51
52     do
53     {
54         // Get the desired product number.
55         prodNum = getProdNum();
56
57         // Search for the product number.
58         index = binarySearch(id, NUM_PRODS,
prodNum);
59
60         // Display the results of the search.
61         if (index == -1)
62             cout << "That product number was
not found.\n";
63         else
```

```

64         displayProd(title, description,
prices, index);
65
66         // Does the user want to do this
again?
67         cout << "Would you like to look up
another product? (y/n) ";
68         cin >> again;
69     } while (again == 'y' || again == 'Y');
70     return 0;
71 }
72
73
//*****
****
74 // Definition of getProdNum function
*
75 // The getProdNum function asks the user to
enter a *
76 // product number. The input is validated,
and when *
77 // a valid number is entered, it is returned.
*
78
//*****
****
79

```

```

80 int getProdNum()
81 {
82     int prodNum; // Product number
83
84     cout << "Enter the item's product number:
";
85     cin >> prodNum;
86     // Validate input
87     while (prodNum < MIN_PRODNUM || prodNum >
MAX_PRODNUM)
88     {
89         cout << "Enter a number in the range
of " << MIN_PRODNUM;
90         cout <<" through " << MAX_PRODNUM <<
".\n";
91         cin >> prodNum;
92     }
93     return prodNum;
94 }
95
96
//*****
*****
97 // Definition of binarySearch function
*
98 // The binarySearch function performs a
binary search on an *
```

```

99 // integer array. array, which has a maximum
of numElems *
100 // elements, is searched for the number
stored in value. If the *
101 // number is found, its array subscript is
returned. Otherwise, *
102 // -1 is returned indicating the value was
not in the array. *
103
//*****
*****
104
105 int binarySearch(const int array[], int
numElems, int value)
106 {
107     int first = 0, // First
array element
108     last = numElems - 1, // Last
array element
109     middle, //
Midpoint of search
110     position = -1; //
Position of search value
111     bool found = false; // Flag
112
113     while (!found && first <= last)
114     {

```



```

115         middle = (first + last) / 2; //
Calculate midpoint
116         if (array[middle] == value) // If
value is found at mid
117             {
118                 found = true;
119                 position = middle;
120             }
121         else if (array[middle] > value) // If
value is in lower half
122             last = middle - 1;
123         else
124             first = middle + 1; // If
value is in upper half
125     }
126     return position;
127 }
128
129
//*****
*****
130 // The displayProd function accepts three
arrays and an int. *
131 // The arrays parameters are expected to hold
the title, *
132 // description, and prices arrays defined in
main. The index *

```

```

133 // parameter holds a subscript. This function
    displays the *
134 // information in each array contained at the
    subscript. *
135
    /*******
    *****
136
137 void displayProd(const string title[], const
    string desc[],
138                 const double price[], int
    index)
139 {
140     cout << "Title: " << title[index] <<
    endl;
141     cout << "Description: " << desc[index] <<
    endl;
142     cout << "Price: $" << price[index] <<
    endl;
143 }

```

**Program Output with Example Input Shown in Bold**

Enter the item's product number: **916** Enter

Title: The Road to Excellence

Description: DVD

Price: \$18.95

Would you like to look up another product?

(y/n) **y** Enter

Enter the item's product number: **920** Enter

Title: Teams Are Made, Not Born

Description: Book

Price: \$14.95

Would you like to look up another product?

(y/n) **n** Enter



## *Checkpoint*

8.1 Describe the difference between the linear search and the binary search.

8.2 On average, with an array of 20,000 elements, how many comparisons will the linear search perform? (Assume the items being searched for are consistently found in the array.)

8.3 With an array of 20,000 elements, what is the maximum number of comparisons the binary search will perform?

8.4 If a linear search is performed on an array, and it is known that some items are searched for more frequently than others, how can the contents of the array be reordered to improve the average performance of the search?

## 8.3 Focus on Software Engineering: Introduction to Sorting Algorithms

### **Concept:**

Sorting algorithms are used to arrange data into some order.

## Sorting Algorithms

Many programming tasks require the data in an array be sorted in some order. Customer lists, for instance, are commonly sorted in alphabetical order. Student grades might be sorted from highest to lowest, and product codes could be sorted so that all the products of the same color are stored together. To sort the data in an array, the programmer must use an appropriate sorting algorithm. A *sorting algorithm* is a technique for stepping through an array and rearranging its contents in some order.

The data in an array can be sorted in either ascending or descending order. If an array is sorted in *ascending order*, it means the values in the array are stored from lowest to highest. If the values are sorted in *descending order*, they are stored from highest to lowest. This section will introduce two simple sorting algorithms: the *bubble sort* and the *selection sort*.

# The Bubble Sort

The bubble sort is an easy way to arrange data in ascending or descending order. It is called the *bubble sort* algorithm because as it makes passes through and compares the elements of the array, certain values “bubble” toward the end of the array with each pass. For example, if you are using the algorithm to sort an array in ascending order, the larger values move toward the end. If you are using the algorithm to sort an array in descending order, the smaller values move toward the end. In this section, you will see how the bubble sort algorithm can be used to sort an array in ascending order.

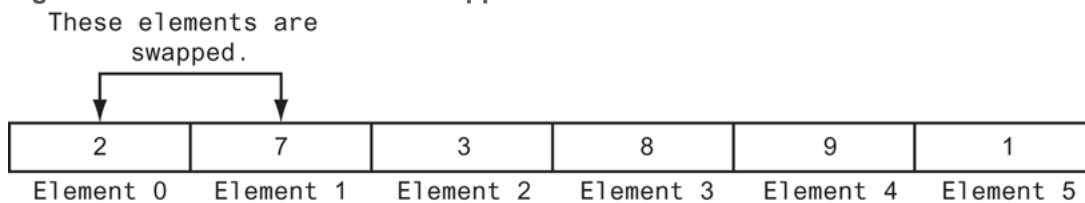
Suppose we have the array shown in [Figure 8-1](#). Let’s see how the bubble sort can be used in arranging the array’s elements in ascending order.

**Figure 8-1 An array**



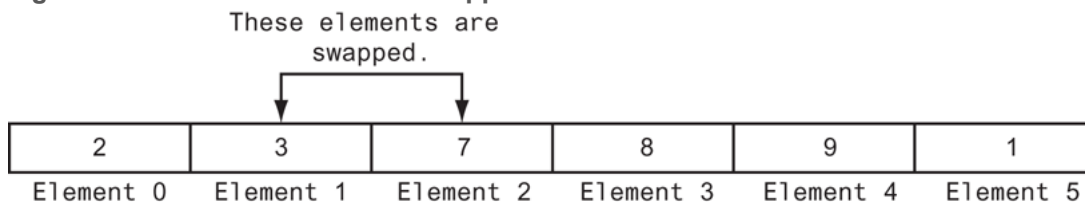
The bubble sort starts by comparing the first two elements in the array. If element 0 is greater than element 1, they are swapped. The array would then appear as shown in [Figure 8-2](#).

**Figure 8-2 Elements 0 and 1 are swapped**



This method is repeated with elements 1 and 2. If element 1 is greater than element 2, they are swapped. The array would then appear as shown in [Figure 8-3](#).

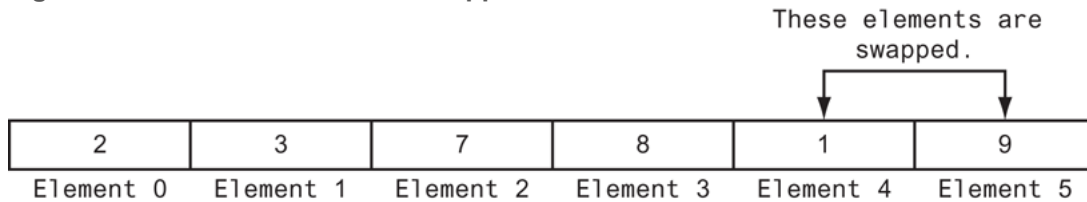
**Figure 8-3 Elements 1 and 2 are swapped**



Next, elements 2 and 3 are compared. In this array, these elements are already in the proper order (element 2 is less than element 3), so no values are swapped. As the cycle continues, elements 3 and 4 are compared. Once again, it is not necessary to swap the values because they are already in the proper order.

When elements 4 and 5 are compared, however, they must be swapped because element 4 is greater than element 5. The array now appears as shown in [Figure 8-4](#).

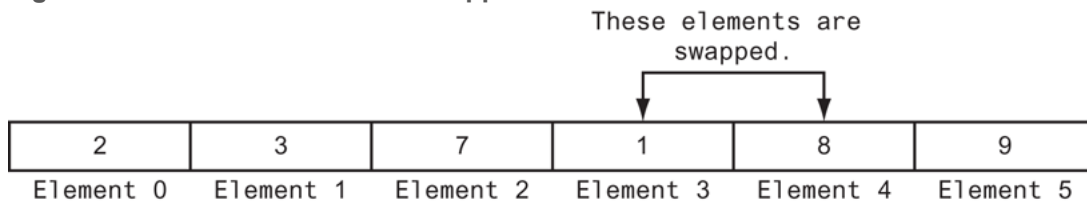
**Figure 8-4 Elements 4 and 5 are swapped**



At this point, the entire array has been scanned once, and the largest value, 9, is in the correct position. There are other elements, however, that are not yet in their final positions. So, the algorithm will make another pass through the array, comparing each element with its neighbor. In the next pass, it will stop comparing after reaching the next-to-last element because the last element already contains the correct value.

The second pass starts by comparing elements 0 and 1. Because those two are in the proper order, they are not swapped. Elements 1 and 2 are compared next, but once again, they are not swapped. This continues until elements 3 and 4 are compared. Because element 3 is greater than element 4, they are swapped. Element 4 is the last element that is compared during this pass, so this pass stops. The array now appears as shown in [Figure 8-5](#).

**Figure 8-5 Elements 3 and 4 are swapped**



At the end of the second pass, the last two elements in the array contain the correct values. The third pass starts now, comparing each element with its neighbor. The third pass will not involve the last two elements, however, because they have already been sorted. When the third pass is finished, the last three elements will hold the correct values, as shown in [Figure 8-6](#).

**Figure 8-6 The array after the third pass**



Each time the algorithm makes a pass through the array, the portion of the array that is scanned is decreased in size by one element, and the largest value in the scanned portion of the array is moved to its final position. When all of the passes have been made, the array will appear as shown in [Figure 8-7](#).

**Figure 8-7 The array with all elements sorted**

1	2	3	7	8	9
Element 0	Element 1	Element 2	Element 3	Element 4	Element 5

Here is the bubble sort algorithm in pseudocode:

```
For maxElement = each subscript in the array, from the last to the first
  For index = 0 To maxElement - 1
    If array[index] > array[index + 1]
      swap array[index] with array[index + 1]
    End If
  End For
End For
```

And here is the C++ code for the bubble sort algorithm written as a function that sorts an array of integers. The function accepts two arguments: the array to sort, and the size of the array.

```
1 void bubbleSort(int array[], int size)
2 {
3     int maxElement;
4     int index;
5
6     for (maxElement = size - 1; maxElement > 0; maxElement--)
7     {
8         for (index = 0; index < maxElement; index++)
9         {
10            if (array[index] > array[index + 1])
11            {
12                swap(array[index], array[index + 1]);
13            }
14        }
15    }
16 }
```

In lines 3 and 4, the following local variables are defined:

- The `maxElement` variable will hold the subscript of the last element that is to be compared to its immediate neighbor.
- The `index` variable is used as an array subscript in one of the loops.



The function uses two `for` loops, one nested inside another. The outer loop begins in line 6 as follows:

```
for (maxElement = size - 1; maxElement > 0; maxElement--)
```

This loop will iterate once for each element in the array. It causes the `maxElement` variable to take on all of the array's subscripts, from the highest subscript down to 0. After each iteration, `maxElement` is decremented by one.

The second loop, which is nested inside the first loop, begins in line 8 as follows:

```
for (index = 0; index < maxElement; index++)
```

This loop iterates once for each of the unsorted array elements. It starts `index` at 0 and increments it up through `maxElement - 1`. During each iteration, the comparison in line 10 is performed:

```
if (array[index] > array[index + 1])
```

This `if` statement compares the element at `array [index]` with its neighbor `array [index + 1]`. If the element's neighbor is greater, the `swap` function is called in line 12 to swap the two elements.

# Swapping Array Elements

As you saw in the description of the bubble sort algorithm, certain elements are swapped as the algorithm steps through the array. Let's briefly discuss the process of swapping two items in computer memory. Assume we have the following variable declarations:

```
int a = 1;
int b = 9;
```

Suppose we want to swap the values in these variables so the variable `a` contains 9, and the variable `b` contains 1. At first, you might think that we only need to assign the variables to each other, like this:

```
// ERROR! The following does NOT swap the variables.
a = b;
b = a;
```

To understand why this doesn't work, let's step through the two lines of code. The first statement

```
a = b;
```

causes the value 9 to be assigned to `a`. But what happens to the value 1 that was previously stored in `a`? Remember, when you assign a new value to a variable, the new value replaces any value that was previously stored in the variable. So, the old value, 1, will be thrown away.

Then, the next statement is

```
b = a;
```

Because the variable `a` contains 9, this assigns 9 to `b`. After these statements execute, the variables `a` and `b` will both contain the value 9.

To successfully swap the contents of two variables, we need a third variable that can serve as a temporary storage location:

```
int temp;
```

Then, we can perform the following steps to swap the values in the variables `a` and `b`:

- Assign the value of `a` to `temp`.
- Assign the value of `b` to `a`.
- Assign the value of `temp` to `b`.


Here is the code for a `swap` function that swaps two `int` arguments:

```
void swap(int &a, int &b)
{
    int temp = a;
    a = b;
    b = temp;
}
```



### **Note:**

It is critical that we use reference parameters in the `swap` function, because the function must be able to change the values of the items that are passed to it as arguments.

**Program 8-4**  demonstrates the `bubbleSort` function in a complete program.

## Program 8-4

```
1 // This program demonstrates the Bubble Sort algorithm.
2 #include <iostream>
3 using namespace std;
4
5 // Function prototypes
6 void bubbleSort(int[], int);
7 void swap(int &, int &);
8
9 int main()
10 {
11     const int SIZE = 6;
12
13     // Array of unsorted values
14     int values[SIZE] = { 6, 1, 5, 2, 4, 3 };
15
16     // Display the unsorted array.
17     cout << "The unsorted values:\n";
18     for (auto element : values)
19         cout << element << " ";
20     cout << endl;
21
22     // Sort the array.
23     bubbleSort(values, SIZE);
24
25     // Display the sorted array.
26     cout << "The sorted values:\n";
27     for (auto element : values)
28         cout << element << " ";
29     cout << endl;
30
31     return 0;
32 }
33
34 //*****
35 // The bubbleSort function sorts an int array in ascending order. *
36 //*****
37 void bubbleSort(int array[], int size)
```

```

38 {
39     int maxElement;
40     int index;
41
42     for (maxElement = size - 1; maxElement > 0; maxElement--)
43     {
44         for (index = 0; index < maxElement; index++)
45         {
46             if (array[index] > array[index + 1])
47             {
48                 swap(array[index], array[index + 1]);
49             }
50         }
51     }
52 }
53
54 //*****
55 // The swap function swaps a and b in memory. *
56 //*****
57 void swap(int &a, int &b)
58 {
59     int temp = a;
60     a = b;
61     b = temp;
62 }

```

## Program Output

```

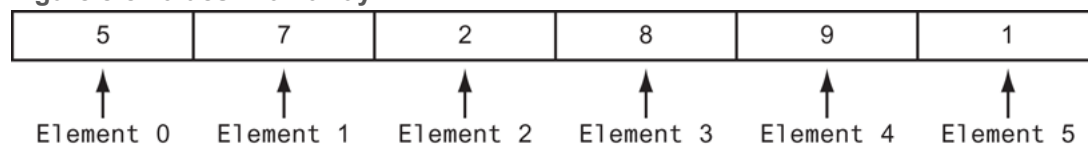
The unsorted values:
6 1 5 2 4 3
The sorted values:
1 2 3 4 5 6

```

# The Selection Sort Algorithm

The bubble sort algorithm is simple, but it is inefficient because values move by only one element at a time toward their final destination in the array. The *selection sort algorithm* usually performs fewer swaps because it moves items immediately to their final position in the array. The selection sort works like this: The smallest value in the array is located and moved to element 0. Then, the next smallest value is located and moved to element 1. This process continues until all of the elements have been placed in their proper order. Let's see how the selection sort works when arranging the elements of the array in [Figure 8-8](#).

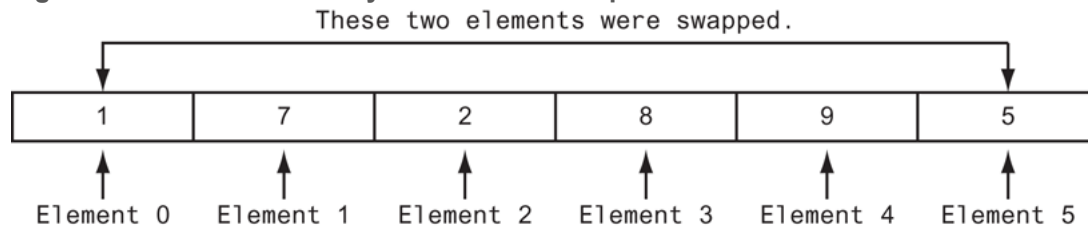
**Figure 8-8** Values in an array



## The Selection Sort

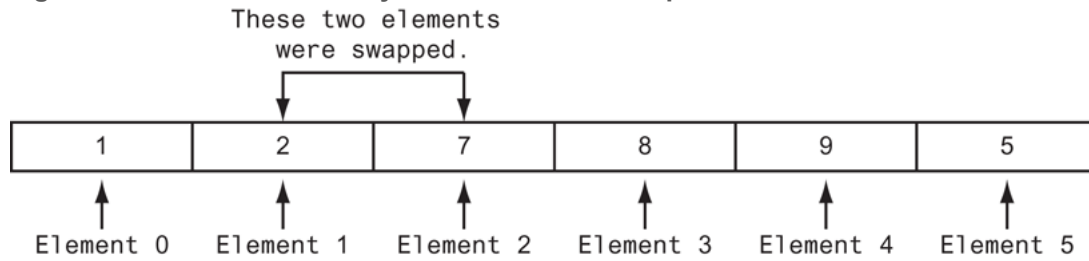
The selection sort scans the array, starting at element 0, and locates the element with the smallest value. Then, the contents of this element are swapped with the contents of element 0. In this example, the 1 stored in element 5 is swapped with the 5 stored in element 0. After the swap, the array appears as shown in [Figure 8-9](#).

**Figure 8-9** Values in the array after the first swap



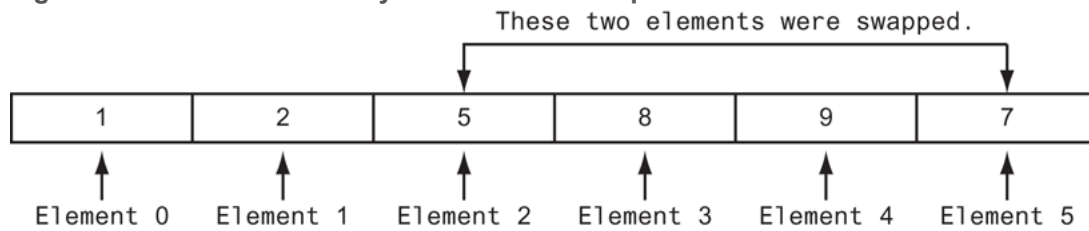
Then, the algorithm repeats the process, but because element 0 already contains the smallest value in the array, it can be left out of the procedure. This time, the algorithm begins the scan at element 1. In this example, the value in element 2 is swapped with the value in element 1. Then, the array appears as shown in [Figure 8-10](#).

**Figure 8-10 Values in the array after the second swap**



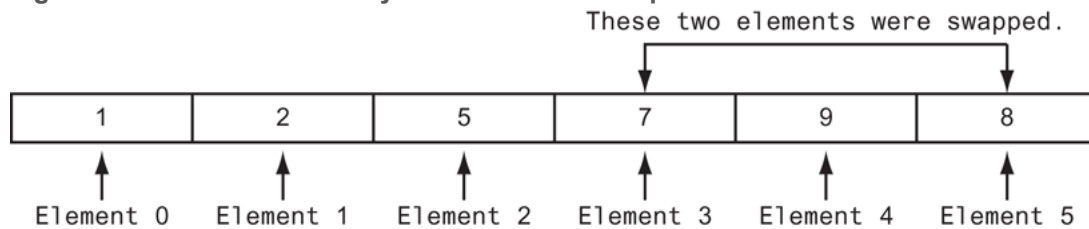
Once again the process is repeated, but this time the scan begins at element 2. The algorithm will find that element 5 contains the next smallest value. This element's value is swapped with that of element 2, causing the array to appear as shown in [Figure 8-11](#).

**Figure 8-11 Values in the array after the third swap**



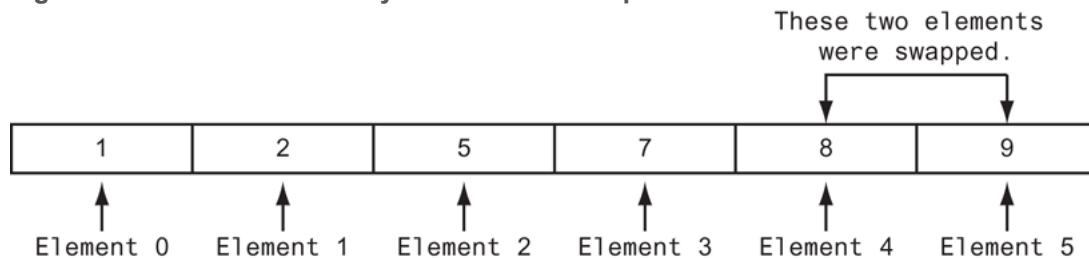
Next, the scanning begins at element 3. Its value is swapped with that of element 5, causing the array to appear as shown in [Figure 8-12](#).

**Figure 8-12 Values in the array after the fourth swap**



At this point, there are only two elements left to sort. The algorithm finds that the value in element 5 is smaller than that of element 4, so the two are swapped. This puts the array in its final arrangement, as shown in [Figure 8-13](#).

**Figure 8-13 Values in the array after the fifth swap**



Here is the selection sort algorithm in pseudocode:

```
For start = each array subscript, from the first to the next-to-last
    minIndex = start
    minValue = array[start]
    For index = start + 1 To size - 1
        If array[index] < minValue
            minValue = array[index]
            minIndex = index
        End If
    End For
    swap array[minIndex] with array[start]
End For
```

The following C++ code implements the selection sort in a function. It accepts two arguments: an integer array, and the size of the array. The function uses the selection sort algorithm to arrange the values in the array in ascending order.

```
1 void selectionSort(int array[], int size)
2 {
3     int minIndex, minValue;
4
5     for (int start = 0; start < (size - 1); start++)
6     {
7         minIndex = start;
8         minValue = array[start];
9         for (int index = start + 1; index < size; index++)
10        {
11            if (array[index] < minValue)
12            {
13                minValue = array[index];
14                minIndex = index;
15            }
16        }
17        swap(array[minIndex], array[start]);
18    }
19 }
```



Inside the function are two `for` loops, one nested inside the other. The inner loop (in lines 9 through 16) sequences through the array, starting at `array [start + 1]`, searching for the element with the smallest value. When the element is found, its subscript is stored in the variable `minIndex`, and its value is stored in `minValue`. The outer loop (lines 5 through 18) then exchanges the contents of this element with `array [start]` and increments `start`. This procedure repeats until the contents of every element have been moved to their proper location.

**Program 8-5**  demonstrates the `selectionSort` function in a complete program.

## Program 8-5

```
1 // This program demonstrates the Selection Sort algorithm.
2 #include <iostream>
3 using namespace std;
4
5 // Function prototypes
6 void selectionSort(int[], int);
7 void swap(int &, int &);
8
9 int main()
10 {
11     const int SIZE = 6;
12
13     // Array of unsorted values
14     int values[SIZE] = { 6, 1, 5, 2, 4, 3 };
15
16     // Display the unsorted array.
17     cout << "The unsorted values:\n";
18     for (auto element : values)
19         cout << element << " ";
20     cout << endl;
21
22     // Sort the array.
23     selectionSort(values, SIZE);
24
25     // Display the sorted array.
26     cout << "The sorted values:\n";
27     for (auto element : values)
28         cout << element << " ";
29     cout << endl;
30
31     return 0;
32 }
33
34 //*****
35 // The selectionSort function sorts an int array in ascending order. *
36 //*****
37 void selectionSort(int array[], int size)
```

```

38 {
39     int minIndex, minValue;
40
41     for (int start = 0; start < (size - 1); start++)
42     {
43         minIndex = start;
44         minValue = array[start];
45         for (int index = start + 1; index < size; index++)
46         {
47             if (array[index] < minValue)
48             {
49                 minValue = array[index];
50                 minIndex = index;
51             }
52         }
53         swap(array[minIndex], array[start]);
54     }
55 }
56
57 //*****
58 // The swap function swaps a and b in memory. *
59 //*****
60 void swap(int &a, int &b)
61 {
62     int temp = a;
63     a = b;
64     b = temp;
65 }

```

## Program Output

```

The unsorted values:
6 1 5 2 4 3
The sorted values:
1 2 3 4 5 6

```

## 8.4 Focus on Problem Solving and Program Design: A Case Study

Like the previous case study, this is a program developed for the Demetris Leadership Center. Recall that DLC, Inc., publishes books, DVDs, and audio CDs. (See [Table 8-1](#) for a complete list of products, with title, description, product number, and price.) [Table 8-4](#) shows the number of units of each product sold during the past six months.

### Table 8-4 Units Sold

The vice president of sales has asked you to write a sales-reporting program that displays the following information:

- A list of the products in the order of their sales dollars (NOT units sold), from highest to lowest
- The total number of all units sold
- The total sales for the 6-month period

# Variables

**Table 8-5**  lists the variables needed.

## Table 8-5 Variables

The elements of the four arrays, `prodNum`, `units`, `prices`, and `sales`, will correspond with each other. For example, the product whose number is stored in `prodNum[2]` will have sold the number of units stored in `units[2]`. The sales amount for the product will be stored in `sales[2]`.

# Modules

The program will consist of the functions listed in **Table 8-6** .

## Table 8-6 Functions

# Function `main`

Function `main` is very simple. It contains the variable definitions and calls the other functions. Here is the pseudocode for its executable statements:

```
Call calcSales  
Call dualSort  
Set display mode to fixed point with two decimal places of  
precision  
Call showOrder  
Call showTotals
```

Here is its actual C++ code:

```
// Calculate each product's sales.
calcSales(units, prices, sales, NUM_PRODS);
// Sort the elements in the sales array in descending
// order and shuffle the ID numbers in the id array to
// keep them in parallel.
dualSort(id, sales, NUM_PRODS);
// Set the numeric output formatting.
cout << setprecision(2) << fixed << showpoint;
// Display the products and sales amounts.
showOrder(sales, id, NUM_PRODS);
// Display total units sold and total sales.
showTotals(sales, units, NUM_PRODS);
```

The named constant `NUM_PRODS` will be defined globally and initialized to the value 9.

The arrays `id`, `units`, and `prices` will already be initialized with data. (It will be left as an exercise for you to modify this program so the user may enter these values.)

# The `calcSales` Function

The `calcSales` function multiplies each product's units sold by its price. The resulting amount is stored in the `sales` array. Here is the function's pseudocode:

```
For index = each array subscript from 0 through the last  
subscript  
    sales[index] = units[index] * prices[index]  
End For
```

And here is the function's actual C++ code:

```
void calcSales(const int units[], const double prices[],  
              double sales[], int num)  
{  
    for (int index = 0; index < num; index++)  
        sales[index] = units[index] * prices[index];  
}
```



# The `dualSort` Function

The `dualSort` function is a modified version of the selection sort algorithm shown in [Program 8-5](#). The `dualSort` function accepts two arrays as arguments: the `sales` array and the `id` array. The function actually performs the selection sort on the `sales` array. When the function moves an element in the `sales` array, however, it also moves the corresponding element in the `id` array. This is to ensure that the product numbers in the `id` array still have subscripts that match their sales figures in the `sales` array.

The `dualSort` function is also different in another way: It sorts the array in descending order. Here is the pseudocode for the `dualSort` function:

```
For start = each array subscript, from the first to the next-  
to-last  
    index = start  
    maxIndex = start  
    tempId = id[start]  
    maxValue = sales[start]  
    For index = start + 1 To size - 1  
        If sales[index] > maxValue  
            maxValue = sales[index]  
            tempId = id[index]  
            maxIndex = index  
        End If  
    End For  
    swap sales[maxIndex] with sales[start]  
    swap id[maxIndex] with id[start]  
End For
```

Here is the actual C++ code for the `dualSort` function:

```
void dualSort(int id[], double sales[], int size)
{
    int start, maxIndex, tempid;
    double maxValue;
    for (start = 0; start < (size - 1); start++)
    {
        maxIndex = start;
        maxValue = sales[start];
        tempid = id[start];
        for (int index = start + 1; index < size; index++)
        {
            if (sales[index] > maxValue)
            {
                maxValue = sales[index];
                tempid = id[index];
                maxIndex = index;
            }
        }
        swap(sales[maxIndex], sales[start]);
        swap(id[maxIndex], id[start]);
    }
}
```



## **Note:**

Once the `dualSort` function is called, the `id` and `sales` arrays are no longer synchronized with the `units` and `prices` arrays. Because this program doesn't use `units` and `prices` together with `id` and `sales` after this point, it will not be noticed in the final output. However, it is never a good programming practice to sort parallel arrays in such a way that they are out of synchronization. It will be left as an exercise for you to modify the program so all the arrays are synchronized and used in the final output of the program.

# The Overloaded `swap` Functions

We have two overloaded versions of the `swap` function in this program: one that swaps `double` values, and another that swaps `int` values. We need two different versions of the `swap` function because the `dualSort` function swaps two elements of the `sales` array, which are `doubles`, then it swaps two elements of the `id` array, which are `ints`. Here is the C++ code for both functions:

```
//*****  
// The swap function swaps doubles a and b in memory. *  
//*****  
void swap(double &a, double &b)  
{  
    double temp = a;  
    a = b;  
    b = temp;  
}  
//*****  
// The swap function swaps ints a and b in memory. *  
//*****  
void swap(int &a, int &b)  
{  
    int temp = a;  
    a = b;  
    b = temp;  
}
```

# The `showOrder` Function

The `showOrder` function displays a heading and the sorted list of product numbers and their sales amounts. It accepts the `id` and `sales` arrays as arguments. Here is its pseudocode:

```
Display heading
```

```
For index = each subscript of the arrays from 0 through the last  
subscript
```

```
    Display id[index]
```

```
    Display sales[index]
```

```
End For
```

Here is the function's actual C++ code:

```
void showOrder(const double sales[], const int id[], int num)
{
    cout << "Product Number\tSales\n";
    cout << "-----\n";
    for (int index = 0; index < num; index++)
    {
        cout << id[index] << "\t\t$";
        cout << setw(8) << sales[index] << endl;
    }
    cout << endl;
}
```



# The `showTotals` Function


The `showTotals` function displays the total number of units of all products sold and the total sales for the period. It accepts the `units` and `sales` arrays as arguments. Here is its pseudocode:

```
totalUnits = 0
totalSales = 0.0
For index = each array subscript from 0 through the last
subscript
    Add units[index] to totalUnits[index]
    Add sales[index] to totalSales
End For
Display totalUnits with appropriate heading
Display totalSales with appropriate heading
```

Here is the function's actual C++ code:

```
void showTotals(const double sales[], const int units[], int
num)
{
    int totalUnits = 0;
    double totalSales = 0.0;
    for (int index = 0; index < num; index++)
    {
        totalUnits += units[index];
        totalSales += sales[index];
    }
    cout << "Total Units Sold: " << totalUnits << endl;
    cout << "Total Sales:      $" << totalSales << endl;
}
```

# The Entire Program

**Program 8-6**  shows the entire program's source code.

## Program 8-6

```
1 // This program produces a sales report for
DLC, Inc.
2 #include <iostream>
3 #include <iomanip>
4 using namespace std;
5
6 // Function prototypes
7 void calcSales(const int[], const double[],
double[], int);
8 void showOrder(const double[], const int[],
int);
9 void dualSort(int[], double[], int);
10 void showTotals(const double[], const int[],
int);
11 void swap(double&, double&);
12 void swap(int&, int&);
13
14 int main()
15 {
16     // NUM_PRODS is the number of products
produced.
17     const int NUM_PRODS = 9;
18
```

```
19 // Array with product ID numbers
20 int id[NUM_PRODS] = { 914, 915, 916, 917,
21 918,
22 919, 920, 921, 922 };
23 // Array with number of units sold for
each product
24 int units[NUM_PRODS] = { 842, 416, 127,
25 514, 437,
26 269, 97, 492, 212
};
27 // Array with product prices
28 double prices[NUM_PRODS] = { 12.95, 14.95,
29 18.95, 16.95, 21.95,
30 31.95, 14.95,
31 14.95, 16.95 };
32 // Array to hold the computed sales
amounts
33 double sales[NUM_PRODS];
34 // Calculate each product's sales.
35 calcSales(units, prices, sales,
NUM_PRODS);
36
37 // Sort the elements in the sales array in
```

```

descending
38     // order and shuffle the ID numbers in the
id array to
39     // keep them in parallel.
40     dualSort(id, sales, NUM_PRODS);
41
42     // Set the numeric output formatting.
43     cout << setprecision(2) << fixed <<
showpoint;
44
45     // Display the products and sales amounts.
46     showOrder(sales, id, NUM_PRODS);
47
48     // Display total units sold and total
sales.
49     showTotals(sales, units, NUM_PRODS);
50     return 0;
51 }
52
53
//*****
*****
54 // Definition of calcSales. Accepts units,
prices, and sales *
55 // arrays as arguments. The size of these
arrays is passed *
56 // into the num parameter. This function

```

```

calculates each *
57 // product's sales by multiplying its units
sold by each unit's *
58 // price. The result is stored in the sales
array. *
59
//*****
*****
60
61 void calcSales(const int units[], const
double prices[], double sales[], int num)
62 {
63     for (int index = 0; index < num; index++)
64         sales[index] = units[index] *
prices[index];
65 }
66
67
//*****
*****
68 // Definition of function dualSort. Accepts
id and sales arrays *
69 // as arguments. The size of these arrays is
passed into size. *
70 // This function performs a descending order
selection sort on *
71 // the sales array. The elements of the id

```

```

array are exchanged *
72 // identically as those of the sales array.
size is the number *
73 // of elements in each array.
*
74
//*****
*****
75
76 void dualSort(int id[], double sales[], int
size)
77 {
78     int start, maxIndex, tempid;
79     double maxValue;
80
81     for (start = 0; start < (size - 1);
start++)
82     {
83         maxIndex = start;
84         maxValue = sales[start];
85         tempid = id[start];
86         for (int index = start + 1; index <
size; index++)
87         {
88             if (sales[index] > maxValue)
89             {
90                 maxValue = sales[index];

```



```
91         tempid = id[index];
92         maxIndex = index;
93     }
94 }
95     swap(sales[maxIndex], sales[start]);
96     swap(id[maxIndex], id[start]);
97 }
98 }
99
100
//*****
*****
101 // The swap function swaps doubles a and b in
memory. *
102
//*****
*****
103 void swap(double &a, double &b)
104 {
105     double temp = a;
106     a = b;
107     b = temp;
108 }
109
110
//*****
*****
```

```
111 // The swap function swaps ints a and b in
memory. *
```

```
112
//*****
*****
113 void swap(int &a, int &b)
114 {
115     int temp = a;
116     a = b;
117     b = temp;
118 }
119
120
//*****
*****
121 // Definition of showOrder function. Accepts
sales and id arrays *
122 // as arguments. The size of these arrays is
passed into num. *
```

```
123 // The function first displays a heading,
then the sorted list *
```

```
124 // of product numbers and sales.
*
125
//*****
*****
126
```

```

127 void showOrder(const double sales[], const
int id[], int num)
128 {
129     cout << "Product Number\tSales\n";
130     cout << "-----
-\n";
131     for (int index = 0; index < num; index++)
132     {
133         cout << id[index] << "\t\t$";
134         cout << setw(8) << sales[index] <<
endl;
135     }
136     cout << endl;
137 }
138
139
//*****
*****
140 // Definition of showTotals function. Accepts
sales and id arrays *
141 // as arguments. The size of these arrays is
passed into num. *
142 // The function first calculates the total
units (of all *
143 // products) sold and the total sales. It
then displays these *
144 // amounts.

```

```

*
145
//*****
*****
146
147 void showTotals(const double sales[], const
int units[], int num)
148 {
149     int totalUnits = 0;
150     double totalSales = 0.0;
151
152     for (int index = 0; index < num; index++)
153     {
154         totalUnits += units[index];
155         totalSales += sales[index];
156     }
157     cout << "Total units Sold:  " <<
totalUnits << endl;
158     cout << "Total sales:      $" <<
totalSales << endl;
159 }

```


## Program Output

Product Number	Sales
914	\$10903.90
918	\$ 9592.15
917	\$ 8712.30
919	\$ 8594.55
921	\$ 7355.40
915	\$ 6219.20
922	\$ 3593.40
916	\$ 2406.65
920	\$ 1450.15
Total Units Sold:	3406
Total Sales:	\$58827.70

## 8.5 Sorting and Searching `vector`s (Continued from **Section 7.11** )

### Concept:

The sorting and searching algorithms you have studied in this chapter may be applied to STL `vectors` as well as arrays.

Once you have properly defined an STL `vector` and populated it with values, you may sort and search the `vector` with the algorithms presented in this chapter. Simply substitute the `vector` syntax for the array syntax when necessary. **Program 8-7**  demonstrates how to use the selection sort and binary search algorithms with a `vector` of strings.

## Program 8-7

```
1 // This program demonstrates how to sort and
search a
2 // string vector using selection sort and
binary search.
3 #include <iostream>
4 #include <string>
5 #include <vector>
6 using namespace std;
7
8 // Function prototypes
9 void selectionSort(vector<string>&);
10 void swap(string &, string &);
11 int binarySearch(const vector<string>&,
string);
12
13 int main()
14 {
15     string searchValue; // Value to search for
16     int position;      // Position of found
value
17
18     // Define a vector of strings.
19     vector<string> names{ "Lopez", "Smith",
```

```
"Pike", "Jones",
20         "Abernathy", "Hall",
"Wilson", "Kimura",
21         "Alvarado", "Harrison",
"Geddes", "Irvine" };
22
23     // Sort the vector.
24     selectionSort(names);
25
26     // Display the vector's elements.
27     cout << "Here are the sorted names:\n";
28     for (auto element : names)
29         cout << element << endl;
30     cout << endl;
31
32     // Search for a name.
33     cout << "Enter a name to search for: ";
34     getline(cin, searchValue);
35     position = binarySearch(names,
searchValue);
36
37     // Display the results.
38     if (position != -1)
39         cout << "That name is found at position
" << position << endl;
40     else
41         cout << "That name is not found.\n";
```



```

42
43     return 0;
44 }
45
46
47 //*****
48 //*****
49 // The selectionSort function sorts a string
vector in ascending order.*
50
51 //*****
52 //*****
53 void selectionSort(vector<string> &v)
54 {
55     int minIndex;
56     string minValue;
57
58     for (int start = 0; start < (v.size() - 1);
start++)
59     {
60         minIndex = start;
61         minValue = v[start];
62         for (int index = start + 1; index <
v.size(); index++)
63         {

```

```

62         minValue = v[index];
63         minIndex = index;
64     }
65 }
66     swap(v[minIndex], v[start]);
67 }
68 }
69
70
//*****
***
71 // The swap function swaps a and b in memory.
*
72
//*****
***
73 void swap(string &a, string &b)
74 {
75     string temp = a;
76     a = b;
77     b = temp;
78 }
79
80
//*****
*****
81 // The binarySearch function performs a binary

```

```

search on a      *
82 // string vector. array, which has a maximum
of size elements, *
83 // is searched for the number stored in value.
If the number is *
84 // found, its vector subscript is returned.
Otherwise, -1 is *
85 // returned indicating the value was not in
the vector.      *
86
//*****
*****
87
88 int binarySearch(const vector<string> &v,
string str)
89 {
90     int first = 0,           // First vector
element
91         last = v.size() - 1, // Last vector
element
92         middle,             // Mid point of
search
93         position = -1;     // Position of
search value
94     bool found = false;    // Flag
95
96     while (!found && first <= last)

```

```
97     {
98         middle = (first + last) / 2; //
Calculate mid point
99         if (v[middle] == str)      // If value
is found at mid
100         {
101             found = true;
102             position = middle;
103         }
104         else if (v[middle] > str)  // If
value is in lower half
105             last = middle - 1;
106         else
107             first = middle + 1;    // If value
is in upper half
108     }
109     return position;
110 }
```

**Program Output with Example Input Shown in Bold**

```
Here are the sorted names:
```

```
Abernathy
```

```
Alvarado
```

```
Geddes
```

```
Hall
```

```
Harrison
```

```
Irvine
```

```
Jones
```

```
Kimura
```

```
Lopez
```

```
Pike
```

```
Smith
```

```
Wilson
```

```
Enter a name to search for: Lopez Enter
```

```
That name is found at position 8
```

**Program Output with Example Input Shown in Bold**

Here are the sorted names:

Abernathy

Alvarado

Geddes

Hall

Harrison

Irvine

Jones

Kimura

Lopez

Pike

Smith

Wilson

Enter a name to search for: **Carter** Enter

That name is not found.

# Review Questions and Exercises

## Short Answer

1. Why is the linear search also called “sequential search”?
2. If a linear search function is searching for a value that is stored in the last element of a 10,000-element array, how many elements will the search code have to read to locate the value?
3. In an average case involving an array of  $N$  elements, how many times will a linear search function have to read the array to locate a specific value?
4. A binary search function is searching for a value that is stored in the middle element of an array. How many times will the function read an element in the array before finding the value?
5. What is the maximum number of comparisons that a binary search function will make when searching for a value in a 1,000-element array?
6. Why is the bubble sort inefficient for large arrays?
7. Why is the selection sort more efficient than the bubble sort on large arrays?

# Fill-in-the-Blank

8. The \_\_\_\_ search algorithm steps sequentially through an array, comparing each item with the search value.
9. The \_\_\_\_ search algorithm repeatedly divides the portion of an array being searched in half.
10. The \_\_\_\_ search algorithm is adequate for small arrays but not large arrays.
11. The \_\_\_\_ search algorithm requires that the array's contents be sorted.
12. If an array is sorted in \_\_\_\_ order, the values are stored from lowest to highest.
13. If an array is sorted in \_\_\_\_ order, the values are stored from highest to lowest.



# True or False

14. T F If data are sorted in ascending order, it means they are ordered from lowest value to highest value.
15. T F If data are sorted in descending order, it means they are ordered from lowest value to highest value.
16. T F The *average* number of comparisons performed by the linear search on an array of  $N$  elements is  $N/2$  (assuming the search values are consistently found).
17. T F The *maximum* number of comparisons performed by the linear search on an array of  $N$  elements is  $N/2$  (assuming the search values are consistently found).
18. Complete the following table calculating the average and maximum number of comparisons the linear search will perform, and the maximum number of comparisons the binary search will perform.

# Programming Challenges

## 1. Charge Account Validation

Write a program that lets the user enter a charge account number. The program should determine if the number is valid by checking for it in the following list:

```
5658845 4520125 7895122 8777541 8451277 1302850
8080152 4562555 5552012 5050552 7825877 1250255
1005231 6545231 3852085 7576651 7881200 4581002
```

The list of numbers above should be initialized in a single-dimensional array. A simple linear search should be used to locate the number entered by the user. If the user enters a number that is in the array, the program should display a message saying the number is valid. If the user enters a number that is not in the array, the program should display a message indicating the number is invalid.

## 2. Lottery Winners

A lottery ticket buyer purchases ten tickets a week, always playing the same ten 5-digit “lucky” combinations. Write a program that initializes an array or a `vector` with these numbers, then lets the player enter this week’s winning 5-digit number. The program should perform a linear search through

the list of the player's numbers and report whether or not one of the tickets is a winner this week. Here are the numbers:

```
13579 26791 26792 33445 55555
62483 77777 79422 85647 93121
```

### 3. Lottery Winners Modification

Modify the program you wrote for Programming Challenge 2 (Lottery Winners) so it performs a binary search instead of a linear search.



### Solving the Charge Account Validation Modification Problem

### 4. Charge Account Validation Modification


Modify the program you wrote for Problem 1 (Charge Account Validation) so it performs a binary search to locate valid account numbers. Use the selection sort algorithm to sort the array before the binary search is performed.

### 5. Rainfall Statistics Modification

Modify the Rainfall Statistics program you wrote for Programming Challenge 2 of [Chapter 7](#) (Rainfall

Statistics). The program should display a list of months, sorted in order of rainfall, from highest to lowest.

## 6. **String Selection Sort**

Modify the `selectionSort` function presented in this chapter so it sorts an array of strings instead of an array of `int`s. Test the function with a driver program. Use [Program 8-8](#)  as a skeleton to complete.

## Program 8-8

```
#include <iostream>
#include <string>
using namespace std;

int main()
{
    const int NUM_NAMES = 20;
    string names[NUM_NAMES] = {"Collins,
Bill", "Smith, Bart", "Allen, Jim",
                                "Griffin,
Jim", "Stamey, Marty", "Rose, Geri",
                                "Taylor,
Terri", "Johnson, Jill",
                                "Allison,
Jeff", "Looney, Joe", "Wolfe, Bill",
                                "James, Jean",
"Weaver, Jim", "Pore, Bob",
                                "Rutherford,
Greg", "Javens, Renee",
                                "Harrison,
Rose", "Setzer, Cathy",
                                "Pike, Gordon",
"Holland, Beth" };

    // Insert your code to complete this
```

```
program
    return 0;
}
```

## 7. Binary String Search

Modify the `binarySearch` function presented in this chapter so it searches an array of strings instead of an array of `int`s. Test the function with a driver program. Use [Program 8-8](#) as a skeleton to complete. (The array must be sorted before the binary search will work.)

## 8. Search Benchmarks

Write a program that has an array of at least 20 integers. It should call a function that uses the linear search algorithm to locate one of the values. The function should keep a count of the number of comparisons it makes until it finds the value. The program then should call a function that uses the binary search algorithm to locate the same value. It should also keep count of the number of comparisons it makes. Display these values on the screen.

## 9. Sorting Benchmarks

Write a program that uses two identical arrays of at least 20 integers. It should call a function that uses the bubble sort algorithm to sort one of the arrays in ascending order. The function should keep a count of the number of exchanges it makes. The program then should call a function that uses the

selection sort algorithm to sort the other array. It should also keep count of the number of exchanges it makes. Display these values on the screen.

#### 10. **Sorting Orders**

Write a program that uses two identical arrays of just eight integers. It should display the contents of the first array, then call a function to sort the array using an ascending order bubble sort modified to print out the array contents after each pass of the sort. Next, the program should display the contents of the second array, then call a function to sort the array using an ascending order selection sort modified to print out the array contents after each pass of the sort.

#### 11. **Using Files—String Selection Sort Modification**

Modify the program you wrote for Programming Challenge 6 (String Selection Sort) so it reads in 20 strings from a file. The data can be found in the names.txt file.

#### 12. **Sorted List of 1994 Gas Prices**

In the student sample programs for this book, you will find a text file named 1994\_Weekly\_Gas\_Averages.txt. The file contains the average gas price for each week in the year 1994. (There are 52 lines in the file. Line 1 contains the average price for week 1; line 2 contains the average price for week 2, and so forth.) Write a program that reads the gas prices from the file, and calculates the average gas price for each month. (To get the average price for a given month, calculate the average of the average weekly prices for that month.) Then, the program should create another file that lists

the names of the months, along with each month's average gas price, sorted from lowest to highest.



---

# Chapter 9 Pointers

---

## Topics

9.1 Getting the Address of a Variable [□](#)

9.2 Pointer Variables [□](#)

9.3 The Relationship between Arrays and Pointers [□](#)

9.4 Pointer Arithmetic [□](#)

9.5 Initializing Pointers [□](#)

9.6 Comparing Pointers [□](#)

9.7 Pointers as Function Parameters [□](#)

9.8 Dynamic Memory Allocation [□](#)

9.9 Returning Pointers from Functions [□](#)

9.10 Using Smart Pointers to Avoid Memory Leaks [□](#)

9.11 Focus on Problem Solving and Program Design: A Case Study [□](#)

## 9.1 Getting the Address of a Variable

### Concept:

The address operator (&) returns the memory address of a variable.

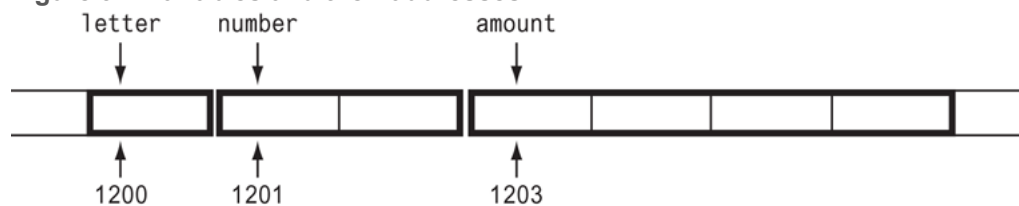
Every variable is allocated a section of memory large enough to hold a value of the variable's data type. On a PC, for instance, it's common for 1 byte to be allocated for `char`s, 2 bytes for `short`s, 4 bytes for `int`s, `long`s, and `float`s, and 8 bytes for `double`s.

Each byte of memory has a unique *address*. A variable's address is the address of the first byte allocated to that variable. Suppose the following variables are defined in a program:

```
char letter;  
short number;  
float amount;
```

**Figure 9-1** illustrates how they might be arranged in memory and shows their addresses.

**Figure 9-1 Variables and their addresses**



In **Figure 9-1**, the variable `letter` is shown at address 1200, `number` is at address 1201, and `amount` is at address 1203.



### Note:

The addresses of the variables shown in [Figure 9-1](#) are arbitrary values used only for illustration purposes.

Getting the address of a variable is accomplished with an operator in C++. When the address operator (`&`) is placed in front of a variable name, it returns the address of that variable. Here is an expression that returns the address of the variable `amount`:

```
&amount
```

And here is a statement that displays the variable's address on the screen:

```
cout << &amount;
```



### Note:

Do not confuse the address operator with the `&` symbol used when defining a reference variable.

[Program 9-1](#) demonstrates the use of the address operator to display the address, size, and contents of a variable.

## Program 9-1

```
1 // This program uses the & operator to determine a variable's
2 // address and the sizeof operator to determine its size.
3 #include <iostream>
4 using namespace std;
5
6 int main()
7 {
8     int x = 25;
9
10    cout << "The address of x is " << &x << endl;
11    cout << "The size of x is " << sizeof(x) << " bytes\n";
12    cout << "The value in x is " << x << endl;
13    return 0;
14 }
```

## Program Output

```
The address of x is 0x8f05
The size of x is 4 bytes
The value in x is 25
```



### Note:

The address of the variable `x` is displayed in hexadecimal. This is the way addresses are normally shown in C++.

## 9.2 Pointer Variables

### Concept:

*Pointer variables*, which are often just called *pointers*, are designed to hold memory addresses. With pointer variables, you can indirectly manipulate data stored in other variables.

A *pointer variable*, which often is just called a *pointer*, is a special variable that holds a memory address. Just as `int` variables are designed to hold integers, and `double` variables are designed to hold floating-point numbers, pointer variables are designed to hold memory addresses.

Memory addresses identify specific locations in the computer's memory. Because a pointer variable holds a memory address, it can be used to hold the location of some other piece of data. This should give you a clue as to why it is called a pointer: It "points" to some piece of data that is stored in the computer's memory. Pointer variables also allow you to work with the data that they point to.

We've already used memory addresses in this book to work with data. Recall from [Chapter 6](#) that when we pass an array as an argument to a function, we are actually passing the array's beginning address. For example, suppose we have an array named `numbers`, and we call the `showValues` function as shown here:

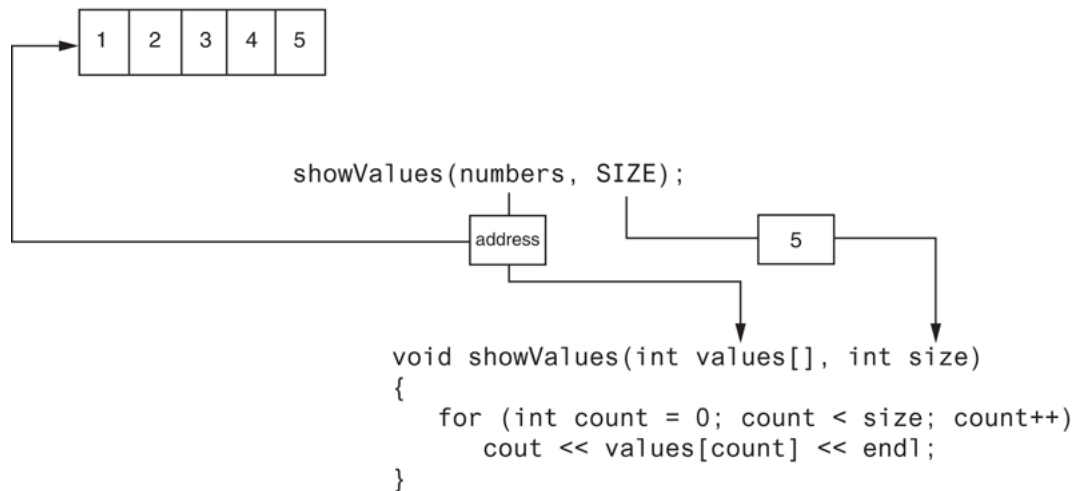
```
const int SIZE = 5;
int numbers[SIZE] = { 1, 2, 3, 4, 5 };
showValues(numbers, SIZE);
```

In this code, we are passing the name of the array, `numbers`, and its size as arguments to the `showValues` function. Here is the definition for the `showValues` function:

```
void showValues(int values[], int size)
{
    for (int count = 0; count < size; count++)
        cout << values[count] << endl;
}
```

In the function, the `values` parameter receives the address of the `numbers` array. It works like a pointer because it “points” to the `numbers` array, as shown in [Figure 9-2](#).

**Figure 9-2** Passing an array to a function  
numbers array



Inside the `showValues` function, anything done to the `values` parameter is actually done to the `numbers` array. We can say that the `values` parameter references the `numbers` array.

Also, recall from [Chapter 6](#) that we discussed reference variables. A reference variable acts as an alias for another variable. It is called a reference variable because it references another variable in the program. Anything you do to the reference variable is actually done to the variable it references. For example, suppose we have the variable `jellyDonuts`, and we pass the variable to the `getOrder` function, as shown here:

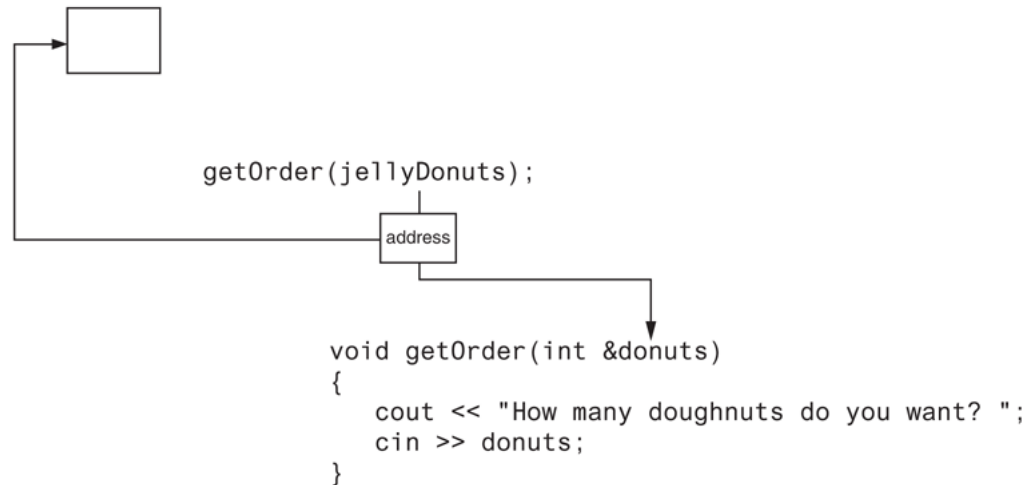
```
int jellyDonuts;
getOrder(jellyDonuts);
```

Here is the definition for the `getOrder` function:

```
void getOrder(int &donuts)
{
    cout << "How many doughnuts do you want? ";
    cin >> donuts;
}
```

In the function, the `donuts` parameter is a reference variable, and it receives the address of the `jellyDonuts` variable. It works like a pointer because it “points” to the `jellyDonuts` variable as shown in [Figure 9-3](#).

**Figure 9-3** Passing an argument by reference  
`jellyDonuts` variable



Inside the `getOrder` function, the `donuts` parameter references the `jellyDonuts` variable. Anything done to the `donuts` parameter is actually done to the `jellyDonuts` variable. When the user enters a value, the `cin` statement uses the `donuts` reference variable to indirectly store the value in the `jellyDonuts` variable.

Notice the connection between the `donuts` reference variable and the `jellyDonuts` argument is automatically established by C++ when the function is called. When you are writing this code, you don't have to go through the trouble of finding the memory address of the `jellyDonuts` variable then properly storing that address in the `donuts` reference variable. When you are storing a value in the `donuts` variable, you don't have to specify that the value should actually be stored in the `jellyDonuts` variable. C++ handles all of that automatically.

In C++, pointer variables are yet another mechanism for using memory addresses to work with pieces of data. Pointer variables are similar to reference variables, but pointer variables operate at a lower level. By this, I mean that C++ does not automatically do as much work for you with pointer variables as it does with reference variables. In order to make a pointer variable reference another item in memory, you have to write code that fetches the memory address of that item and assigns the address to the pointer variable. Also, when you use a pointer variable to store a value in the memory location that the pointer references, your code has to specify that the value should be stored in the location referenced by the pointer variable, and not in the pointer variable itself.

Because reference variables are easier to work with, you might be wondering why you would ever use pointers at all. In C++, pointers are useful, and even necessary, for many operations. One such operation is dynamic memory allocation. When you are writing a program that will need to work with an unknown amount of data, dynamic memory allocation allows you to create variables, arrays, and more complex data structures in memory while the program is running. We will discuss dynamic memory allocation in greater detail in this chapter. Pointers are also very useful in algorithms that manipulate arrays and work with certain types of strings. In object-oriented programming, which you will learn about in [Chapters 13](#), [14](#), and [15](#), pointers are very useful for creating and working with objects, and for sharing access to those objects.



# Creating and Using Pointer Variables

The definition of a pointer variable looks pretty much like any other definition. Here is an example:

```
int *ptr;
```

The asterisk in front of the variable name indicates that `ptr` is a pointer variable. The `int` data type indicates that `ptr` can be used to hold the address of an integer variable. The definition statement above would read “`ptr` is a pointer to an `int`.”



## Note:

In this definition, the word `int` does not mean `ptr` is an integer variable. It means `ptr` can hold the address of an integer variable. Remember, pointers only hold one kind of value: an address.

Some programmers prefer to define pointers with the asterisk next to the type name, rather than the variable name. For example, the previous definition shown above could be written as:

```
int* ptr;
```

This style of definition might visually reinforce the fact that `ptr`'s data type is not `int`, but pointer-to-`int`. Both definition styles are correct.

**11** It is never a good idea to define a pointer variable without initializing it with a valid memory address. If you inadvertently use an uninitialized pointer variable, you will be affecting some unknown location in memory. For that reason, it is a good idea to initialize pointer variables with the special value `nullptr`.


In C++ 11, the `nullptr` key word was introduced to represent the address 0. So, assigning `nullptr` to a pointer variable makes the variable point to the address 0. When a pointer is set to the address 0, it is referred to as a *null pointer* because it points to “nothing.” Here is an example of how you define a pointer variable and initialize it with the value `nullptr`:

```
int *ptr = nullptr;
```



**Note:**

If you are using an older compiler that does not support the C++ 11 standard, you should initialize pointers with the integer 0, or the value `NULL`. The value `NULL` is defined in the `<iostream>` header file (as well as other header files) to represent the value 0.

**Program 9-2**  demonstrates a very simple usage of a pointer: storing and printing the address of another variable.

## Program 9-2

```
1 // This program stores the address of a variable in a pointer.
2 #include <iostream>
3 using namespace std;
4
5 int main()
6 {
7     int x = 25;           // int variable
8     int *ptr = nullptr;  // Pointer variable, can point to an int
9
10    ptr = &x;            // Store the address of x in ptr
11    cout << "The value in x is " << x << endl;
12    cout << "The address of x is " << ptr << endl;
13    return 0;
14 }
```

### Program Output

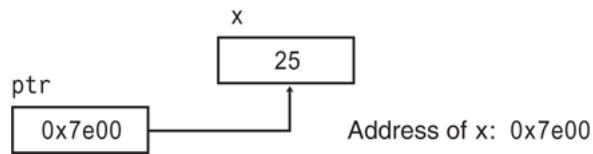
```
The value in x is 25
The address of x is 0x7e00
```

In [Program 9-2](#), two variables are defined: `x` and `ptr`. The variable `x` is an `int`, and the variable `ptr` is a pointer to an `int`. The variable `x` is initialized with the value 25, and `ptr` is initialized with `nullptr`. Then, the variable `ptr` is assigned the address of `x` with the following statement in line 10:

```
ptr = &x;
```

[Figure 9-4](#) illustrates the relationship between `ptr` and `x`.

Figure 9-4 `ptr` points to `x`



As shown in [Figure 9-4](#), `x`, which is located at memory address `0x7e00`, contains the number `25`. The `ptr` pointer contains the address `0x7e00`. In essence, it “points” to the variable `x`.

The real benefit of pointers is that they allow you to indirectly access and modify the variable being pointed to. In [Program 9-2](#), for instance, `ptr` could be used to change the contents of the variable `x`. This is done with the *indirection operator*, which is an asterisk (\*). When the indirection operator is placed in front of a pointer variable name, it *dereferences* the pointer. When you are working with a dereferenced pointer, you are actually working with the value the pointer is pointing to. This is demonstrated in [Program 9-3](#).

## Program 9-3

```
1 // This program demonstrates the use of the indirection operator.
2 #include <iostream>
3 using namespace std;
4
5 int main()
6 {
7     int x = 25;           // int variable
8     int *ptr = nullptr;  // Pointer variable, can point to an int
9
10    ptr = &x;            // Store the address of x in ptr
11
12    // Use both x and ptr to display the value in x.
13    cout << "Here is the value in x, printed twice:\n";
14    cout << x << endl;    // Displays the contents of x
15    cout << *ptr << endl; // Displays the contents of x
16
17    // Assign 100 to the location pointed to by ptr. This
18    // will actually assign 100 to x.
19    *ptr = 100;
20
21    // Use both x and ptr to display the value in x.
22    cout << "Once again, here is the value in x:\n";
23    cout << x << endl;    // Displays the contents of x
24    cout << *ptr << endl; // Displays the contents of x
25    return 0;
26 }
```

## Program Output

```
Here is the value in x, printed twice:  
25  
25  
Once again, here is the value in x:  
100  
100
```

Take a closer look at the statement in line 10:

```
ptr = &x;
```

This statement assigns the address of the `x` variable to the `ptr` variable. Now look at line 15:

```
cout << *ptr << endl; // Displays the contents of x
```

When you apply the indirection operator (`*`) to a pointer variable, you are working not with the pointer variable itself, but with the item it points to. Because this statement sends the expression `*ptr` to the `cout` object, it does not display the value in `ptr`, but the value that `ptr` points to. Since `ptr` points to the `x` variable, this statement displays the contents of the `x` variable.

Suppose the statement did not use the indirection operator. Suppose that statement had been written as:

```
cout << ptr << endl; // Displays an address
```

Because the indirection operator is not applied to `ptr` in this statement, it works directly with the `ptr` variable. This statement would display the address that is stored in `ptr`.

Now take a look at the following statement, which appears in line 19:

```
*ptr = 100;
```

Notice the indirection operator being used with `ptr`. That means the statement is not affecting `ptr`, but the item that `ptr` points to. This statement assigns 100 to the item `ptr` points to, which is the `x` variable. After this statement executes, 100 will be stored in the `x` variable.

**Program 9-4**  demonstrates that pointers can point to different variables.

## Program 9-4

```
1 // This program demonstrates a pointer variable referencing
2 // different variables.
3 #include <iostream>
4 using namespace std;
5
6 int main()
7 {
8     int x = 25, y = 50, z = 75; // Three int variables
9     int *ptr = nullptr;        // Pointer variable
10
11     // Display the contents of x, y, and z.
12     cout << "Here are the values of x, y, and z:\n";
13     cout << x << " " << y << " " << z << endl;
14
15     // Use the pointer to manipulate x, y, and z.
16
17     ptr = &x; // Store the address of x in ptr.
18     *ptr += 100; // Add 100 to the value in x.
19
20     ptr = &y; // Store the address of y in ptr.
21     *ptr += 100; // Add 100 to the value in y.
22
23     ptr = &z; // Store the address of z in ptr.
24     *ptr += 100; // Add 100 to the value in z.
25
26     // Display the contents of x, y, and z.
27     cout << "Once again, here are the values of x, y, and z:\n";
28     cout << x << " " << y << " " << z << endl;
29     return 0;
30 }
```

## Program Output



```
Here are the values of x, y, and z:  
25 50 75  
Once again, here are the values of x, y, and z:  
125 150 175
```

Take a closer look at the statement in line 17:

```
ptr = &x;
```

This statement assigns the address of the `x` variable to the `ptr` variable. Now look at line 18:

```
*ptr += 100;
```

In this statement, notice the indirection operator (`*`) is used with the `ptr` variable. When we apply the indirection operator to `ptr`, we are working not with `ptr`, but with the item that `ptr` points to. When this statement executes, `ptr` is pointing at `x`, so the statement in line 18 adds 100 to the contents of `x`. Then the following statement, in line 20, executes:

```
ptr = &y;
```

This statement assigns the address of the `y` variable to the `ptr` variable. After this statement executes, `ptr` is no longer pointing at `x`. Rather, it will be pointing at `y`. The statement in line 21, shown here, adds 100 to the `y` variable:

```
*ptr += 100;
```

These steps are repeated with the `z` variable in lines 23 and 24.



### **Note:**

So far, you've seen three different uses of the asterisk in C++:

- As the multiplication operator, in statements such as

```
distance = speed * time;
```

- In the definition of a pointer variable, such as

```
int *ptr = nullptr;
```

- As the indirection operator, in statements such as

```
*ptr = 100;
```

## 9.3 The Relationship between Arrays and Pointers

### Concept:

Array names can be used as constant pointers, and pointers can be used as array names.

You learned in [Chapter 7](#) that an array name, without brackets and a subscript, actually represents the starting address of the array. This means that an array name is really a pointer. [Program 9-5](#) illustrates this by showing an array name being used with the indirection operator.

### Program 9-5

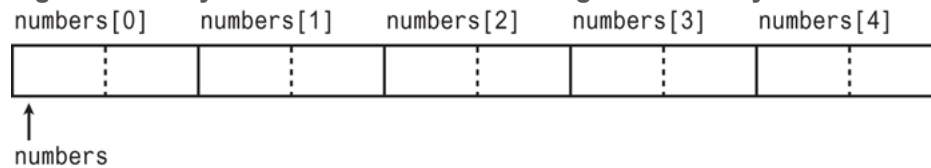
```
1 // This program shows an array name being dereferenced with the *
2 // operator.
3 #include <iostream>
4 using namespace std;
5
6 int main()
7 {
8     short numbers[] = {10, 20, 30, 40, 50};
9
10    cout << "The first element of the array is ";
11    cout << *numbers << endl;
12    return 0;
13 }
```

### Program Output

```
The first element of the array is 10
```

Because `numbers` works like a pointer to the starting address of the array, the first element is retrieved when `numbers` is dereferenced. So how could the entire contents of an array be retrieved using the indirection operator? Remember, array elements are stored together in memory, as illustrated in [Figure 9-5](#).

**Figure 9-5** Array elements are stored in contiguous memory locations



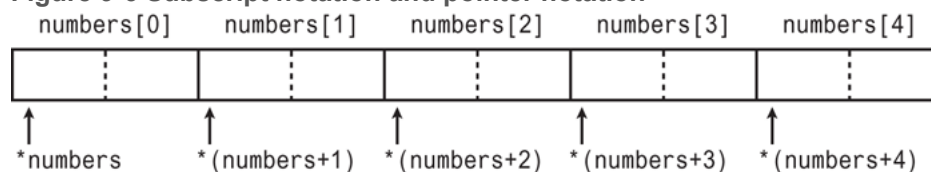
It makes sense that if `numbers` is the address of `numbers[0]`, values could be added to `numbers` to get the addresses of the other elements in the array. It's important to know, however, that pointers do not work like regular variables when used in mathematical statements. In C++, when you add a value to a pointer, you are actually adding that value *times the size of the data type being referenced by the pointer*. In other words, if you add one to `numbers`, you are actually adding `1 * sizeof(short)` to `numbers`. If you add 2 to `numbers`, the result is `numbers + 2 * sizeof(short)`, and so forth. On a typical system, this means the following are true, because `short` integers typically use 2 bytes:

```
* (numbers + 1) is actually *(numbers + 1 * 2)
*(numbers + 2) is actually *(numbers + 2 * 2)
*(numbers + 3) is actually *(numbers + 3 * 2)
```

and so forth.

This automatic conversion means an element in an array can be retrieved by using its subscript, or by adding its subscript to a pointer to the array. If the expression `*numbers`, which is the same as `*(numbers + 0)`, retrieves the first element in the array, then `*(numbers + 1)` retrieves the second element. Likewise, `*(numbers + 2)` retrieves the third element, and so forth. [Figure 9-6](#) shows the equivalence of subscript notation and pointer notation.

**Figure 9-6** Subscript notation and pointer notation





### Note:

The parentheses are critical when adding values to pointers. The `*` operator has precedence over the `+` operator, so the expression `*number + 1` is not equivalent to `*(number + 1)`.

`*number + 1` adds one to the contents of the first element of the array, while `*(number + 1)` adds one to the address in `number`, then dereferences it.

**Program 9-6** shows the entire contents of the array being accessed, using pointer notation.

## Program 9-6

```
1 // This program processes an array using pointer notation.
2 #include <iostream>
3 using namespace std;
4
5 int main()
6 {
7     const int SIZE = 5; // Size of the array
8     int numbers[SIZE]; // Array of integers
9     int count;         // Counter variable
10
11     // Get values to store in the array.
12     // Use pointer notation instead of subscripts.
13     cout << "Enter " << SIZE << " numbers: ";
14     for (count = 0; count < SIZE; count++)
15         cin >> *(numbers + count);
16
17     // Display the values in the array.
18     // Use pointer notation instead of subscripts.
19     cout << "Here are the numbers you entered:\n";
20     for (count = 0; count < SIZE; count++)
21         cout << *(numbers + count) << " ";
22     cout << endl;
23     return 0;
24 }
```

### Program Output with Example Input Shown in Bold

```
Enter 5 numbers: 5 10 15 20 25 Enter
Here are the numbers you entered:
5 10 15 20 25
```

When working with arrays, remember the following rule:

`array[index]` is equivalent to `*(array + index)`



### Warning!

Remember that C++ performs no bounds checking with arrays. When stepping through an array with a pointer, it's possible to give the pointer an address outside of the array.

To demonstrate just how close the relationship is between array names and pointers, look at [Program 9-7](#). It defines an array of `double`s and a `double` pointer, which is assigned the starting address of the array. Not only is pointer notation then used with the array name, but subscript notation is also used with the pointer!

## Program 9-7

```
1 // This program uses subscript notation with a pointer variable and
2 // pointer notation with an array name.
3 #include <iostream>
4 using namespace std;
5
6 int main()
7 {
8     const int NUM_COINS = 5;
9     double coins[NUM_COINS] = {0.05, 0.1, 0.25, 0.5, 1.0};
10    double *doublePtr; // Pointer to a double
11    int count; // Array index
12
13    // Assign the address of the coins array to doublePtr.
14    doublePtr = coins;
15
16    // Display the contents of the coins array. Use subscripts
17    // with the pointer!
18    cout << "Here are the values in the coins array:\n";
19    for (count = 0; count < NUM_COINS; count++)
20        cout << doublePtr[count] << " ";
21
22    // Display the contents of the array again, but this time
23    // use pointer notation with the array name!
24    cout << "\nAnd here they are again:\n";
25    for (count = 0; count < NUM_COINS; count++)
26        cout << *(coins + count) << " ";
27    cout << endl;
28    return 0;
29 }
```

## Program Output



```
Here are the values in the coins array:
```

```
0.05 0.1 0.25 0.5 1
```

```
And here they are again:
```

```
0.05 0.1 0.25 0.5 1
```

Notice the address operator is not needed when an array's address is assigned to a pointer. Because the name of an array is already an address, use of the `&` operator would be incorrect. You can, however, use the address operator to get the address of an individual element in an array. For instance, `&numbers[1]` gets the address of `numbers[1]`. This technique is used in [Program 9-8](#).

## Program 9-8

```
1 // This program uses the address of each element in the array.
2 #include <iostream>
3 using namespace std;
4
5 int main()
6 {
7     const int NUM_COINS = 5;
8     double coins[NUM_COINS] = {0.05, 0.1, 0.25, 0.5, 1.0};
9     double *doublePtr = nullptr;    // Pointer to a double
10    int count;                       // Array index
11
12    // Use the pointer to display the values in the array.
13    cout << "Here are the values in the coins array:\n";
14    for (count = 0; count < NUM_COINS; count++)
15    {
16        // Get the address of an array element.
17        doublePtr = &coins[count];
18
19        // Display the contents of the element.
20        cout << *doublePtr << " ";
21    }
22    cout << endl;
23    return 0;
24 }
```

## Program Output

```
Here are the values in the coins array:
0.05 0.1 0.25 0.5 1
```

The only difference between array names and pointer variables is that you cannot change the address an array name points to. For example, consider the following definitions:

```
double readings[20], totals[20];  
double *dptr = nullptr;
```

These statements are legal:

```
dptr = readings; // Make dptr point to readings.  
dptr = totals;  // Make dptr point to totals.
```

But these are illegal:


```
readings = totals; // ILLEGAL! Cannot change readings.  
totals = dptr;     // ILLEGAL! Cannot change totals.
```

Array names are *pointer constants*. You can't make them point to anything but the array they represent.

## 9.4 Pointer Arithmetic

### **Concept:**

Some mathematical operations may be performed on pointers.

The contents of pointer variables may be changed with mathematical statements that perform addition or subtraction. This is demonstrated in [Program 9-9](#) . The first loop increments the pointer variable, stepping it through each element of the array. The second loop decrements the pointer, stepping it backwards through the array.

## Program 9-9

```
1 // This program uses a pointer to display the
contents of an array.
2 #include <iostream>
3 using namespace std;
4
5 int main()
6 {
7     const int SIZE = 8;
8     int set[SIZE] = {5, 10, 15, 20, 25, 30,
35, 40};
9     int *numPtr = nullptr; // Pointer
10    int count; // Counter variable
for loops
11
12    // Make numPtr point to the set array.
13    numPtr = set;
14
15    // Use the pointer to display the array
contents.
16    cout << "The numbers in set are:\n";
17    for (count = 0; count < SIZE; count++)
18    {
19        cout << *numPtr << " ";
```

```
20         numPtr++;
21     }
22
23     // Display the array contents in reverse
order.
24     cout << "\nThe numbers in set backward
are:\n";
25     for (count = 0; count < SIZE; count++)
26     {
27         numPtr--;
28         cout << *numPtr << " ";
29     }
30     return 0;
31 }
```

## Program Output

```
The numbers in set are:
5 10 15 20 25 30 35 40
The numbers in set backward are:
40 35 30 25 20 15 10 5
```



## Note:

Because `numPtr` is a pointer to an integer, the increment operator adds the size of one integer to `numPtr`, so it points to the next element in the array. Likewise, the decrement operator subtracts the size of one integer from the pointer.

Not all arithmetic operations may be performed on pointers. For example, you cannot multiply or divide a pointer. The following operations are allowable:

- The `++` and `--` operators may be used to increment or decrement a pointer variable.
- An integer may be added to or subtracted from a pointer variable. This may be performed with the `+` and `-` operators, or the `+=` and `-=` operators.
- A pointer may be subtracted from another pointer.

## 9.5 Initializing Pointers

### Concept:

Pointers may be initialized with the address of an existing object.

Remember a pointer is designed to point to an object of a specific data type. When a pointer is initialized with an address, it must be the address of an object the pointer can point to. For instance, the following definition of `pint` is legal because `myValue` is an integer:

```
int myValue;  
int *pint = &myValue;
```

The following is also legal because `ages` is an array of integers:

```
int ages[20];  
int *pint = ages;
```



But the following definition of `pint` is illegal because `myFloat` is not an `int`:

```
float myFloat;  
int *pint = &myFloat; // Illegal!
```

Pointers may be defined in the same statement as other variables of the same type. The following statement defines an integer variable, `myValue`, then defines a pointer, `pint`, which is initialized with the address of `myValue`:

```
int myValue, *pint = &myValue;
```

And the following statement defines an array, `readings`, and a pointer, `marker`, which is initialized with the address of the first element in the array:

```
double readings[50], *marker = readings;
```

Of course, a pointer can only be initialized with the address of an object that has already been defined. The following is illegal, because `pint` is being initialized with the address of an object that does not exist yet:

```
int *pint = &myValue; // Illegal!
```

```
int myValue;
```

# Checkpoint

9.1 Write a statement that displays the address of the variable `count`.

9.2 Write the definition statement for a variable `fltPtr`. The variable should be a pointer to a `float`.

9.3 List three uses of the `*` symbol in C++.

9.4 What is the output of the following code?

```
int x = 50, y = 60, z = 70;
int *ptr = nullptr;

cout << x << " " << y << " " << z << endl;

ptr = &x;
*ptr *= 10;
ptr = &y;
*ptr *= 5;
ptr = &z;
*ptr *= 2;

cout << x << " " << y << " " << z << endl;
```

9.5 Rewrite the following loop so it uses pointer notation (with the indirection operator) instead of subscript notation.

```
for (int x = 0; x < 100; x++)  
    cout << arr[x] << endl;
```

9.6 Assume `ptr` is a pointer to an `int` and holds the address 12000. On a system with 4-byte integers, what address will be in `ptr` after the following statement?

```
ptr += 10;
```

9.7 Assume `paint` is a pointer variable. Is each of the following statements valid or invalid? If any is invalid, why?

- A. `paint++;`
- B. `--paint;`
- C. `paint /= 2;`
- D. `paint *= 4;`
- E. `paint += x; // Assume x is an int.`

9.8 Is each of the following definitions valid or invalid? If any is invalid, why?

- A. `int ivar;`  
`int *iptr = &ivar;`
- B. `int ivar, *iptr = &ivar;`
- C. `float fvar;`  
`int *iptr = &fvar;`
- D. `int nums[50], *iptr = nums;`
- E. `int *iptr = &ivar;`

```
int ivar;
```

## 9.6 Comparing Pointers

### Concept:

If one address comes before another address in memory, the first address is considered “less than” the second. C++’s relational operators may be used to compare pointer values.

Pointers may be compared by using any of C++’s relational operators:

```
>> < == != >= <=
```

In an array, all the elements are stored in consecutive memory locations, so the address of element 1 is greater than the address of element 0. This is illustrated in [Figure 9-7](#).

**Figure 9-7 Array elements**

An array of five integers



Because the addresses grow larger for each subsequent element in the array, the expressions tested by the following `if` statements are all true:

```
if (&arr[1] > &arr[0])  
if (arr < &arr[4])  
if (arr == &arr[0])  
if (&arr[2] != &arr[3])
```



## Note:

Comparing two pointers is not the same as comparing the values the two pointers point to. For example, the following `if` statement compares the addresses stored in the pointer variables `ptr1` and `ptr2`:

```
if (ptr1 < ptr2)
```

The following statement, however, compares the values that `ptr1` and `ptr2` point to:

```
if (*ptr1 < *ptr2)
```

The capability of comparing addresses gives you another way to be sure a pointer does not go beyond the boundaries of an array. [Program 9-10](#) initializes the pointer `ptr` with the starting address of the array `numbers`. The `ptr` pointer is then stepped through the `numbers` array until the address it contains is equal to the address of the last element of the array. Then, the pointer is stepped backward through the array until it points to the first element.

## Program 9-10

```
1 // This program uses a pointer to display the contents
2 // of an integer array.
3 #include <iostream>
4 using namespace std;
5
6 int main()
7 {
8     const int SIZE = 8;
9     int numbers[SIZE] = {5, 10, 15, 20, 25, 30, 35, 40};
10    int *ptr = numbers;    // Make ptr point to numbers
11
12    // Display the numbers in the array.
13    cout << "The numbers are:\n";
14    cout << *ptr << " ";    // Display first element
15    while (ptr < &numbers[SIZE - 1])
16    {
17        // Advance ptr to point to the next element.
18        ptr++;
19        // Display the value pointed to by ptr.
20        cout << *ptr << " ";
21    }
22
23    // Display the numbers in reverse order.
24    cout << "\nThe numbers backward are:\n";
25    cout << *ptr << " ";    // Display first element
26    while (ptr > numbers)
27    {
28        // Move backward to the previous element.
29        ptr--;
30        // Display the value pointed to by ptr.
31        cout << *ptr << " ";
32    }
33    return 0;
34 }
```

## Program Output



The numbers are:

5 10 15 20 25 30 35 40

The numbers backward are:

40 35 30 25 20 15 10 5

# 9.7 Pointers as Function Parameters

## Concept:

A pointer can be used as a function parameter. It gives the function access to the original argument, much like a reference parameter does.

In [Chapter 6](#), you were introduced to the concept of reference variables being used as function parameters. A reference variable acts as an alias to the original variable used as an argument. This gives the function access to the original argument variable, allowing it to change the variable's contents. When a variable is passed into a reference parameter, the argument is said to be passed by reference.

Another way to pass an argument by reference is to use a pointer variable as the parameter. Admittedly, reference variables are much easier to work with than pointers. Reference variables hide all the “mechanics” of dereferencing and indirection. You should still learn to use pointers as function arguments, however, because some tasks

(especially when you are dealing with strings) are best done with pointers.\* Also, the C++ library has many functions that use pointers as parameters.

\*It is also important to learn this technique in case you ever need to write a C program. In C, the only way to pass a variable by reference is to use a pointer.

Here is the definition of a function that uses a pointer parameter:


```
void doubleValue(int *val)
{
    *val *= 2;
}
```

The purpose of this function is to double the variable pointed to by `val` with the following statement:

```
*val *= 2;
```

When `val` is dereferenced, the `*` operator works on the variable pointed to by `val`. This statement multiplies the original variable, whose address is stored in `val`, by 2. Of course, when the function is called, the address of the variable that is to be doubled must be used as the argument, not the variable itself. Here is an example of a call to the `doubleValue` function:

```
doubleValue (&number) ;
```

This statement uses the address operator (`&`) to pass the address of `number` into the `val` parameter. After the function executes, the contents of `number` will have been multiplied by 2. The use of this function is illustrated in [Program 9-11](#) .

## Program 9-11

```
1 // This program uses two functions that accept
addresses of
2 // variables as arguments.
3 #include <iostream>
4 using namespace std;
5
6 // Function prototypes
7 void getNumber(int *);
8 void doubleValue(int *);
9
10 int main()
11 {
12     int number;
13
14     // Call getNumber and pass the address of
number.
15     getNumber(&number);
16
17     // Call doubleValue and pass the address
of number.
18     doubleValue(&number);
19
20     // Display the value in number.
```

```

21     cout << "That value doubled is " << number
<< endl;
22     return 0;
23 }
24
25
//*****
*****
26 // Definition of getNumber. The parameter,
input, is a pointer. *
27 // This function asks the user for a number.
The value entered *
28 // is stored in the variable pointed to by
input. *
29
//*****
*****
30
31 void getNumber(int *input)
32 {
33     cout << "Enter an integer number: ";
34     cin >> *input;
35 }
36
37
//*****
*****

```

```

38 // Definition of doubleValue. The parameter,
val, is a pointer. *
39 // This function multiplies the variable
pointed to by val by *
40 // two.
*
41
//*****
*****
42
43 void doubleValue(int *val)
44 {
45     *val *= 2;
46 }


```

### Program Output with Example Input Shown in Bold

```

Enter an integer number: 10 Enter
That value doubled is 20

```

**Program 9-11**  has two functions that use pointers as parameters. Notice the function prototypes:

```
void getNumber(int *);  
void doubleValue(int *);
```

Each one uses the notation `int *` to indicate the parameter is a pointer to an `int`. As with all other types of parameters, it isn't necessary to specify the name of the variable in the prototype. The `*` is required, though.

The `getNumber` function asks the user to enter an integer value. The following `cin` statement, in line 34, stores the value entered by the user in memory:

```
cin >> *input;
```

The indirection operator causes the value entered by the user to be stored, not in `input`, but in the variable pointed to by `input`.






## Warning!

It's critical that the indirection operator be used in the statement above. Without it, `cin` would store the value entered by the user in `input`, as if the value were an address. If this happens, `input` will no longer point to the `number` variable in function `main`. Subsequent use of the pointer will result in erroneous, if not disastrous, results.

When the `getNumber` function is called in line 15, the address of the `number` variable in function `main` is passed as the argument. After the function executes, the value entered by the user is stored in `number`. Next, the `doubleValue` function is called in line 18, with the address of `number` passed as the argument. This causes `number` to be multiplied by 2.

Pointer variables can also be used to accept array addresses as arguments. Either subscript or pointer notation may then be used to work with the contents of the array. This is demonstrated in [Program 9-12](#) .

## Program 9-12

```
1 // This program demonstrates that a pointer
may be used as a
2 // parameter to accept the address of an
array.
3 #include <iostream>
4 #include <iomanip>
5 using namespace std;
6
7 // Function prototypes
8 void getSales(double *, int);
9 double totalSales(double *, int);
10
11 int main()
12 {
13     const int QTRS = 4;
14     double sales[QTRS];
15
16     // Get the sales data for all quarters.
17     getSales(sales, QTRS);
18
19     // Set the numeric output formatting.
20     cout << fixed << showpoint <<
setprecision(2);
```

```

21
22     // Display the total sales for the year.
23     cout << "The total sales for the year are
24     $";
25     cout << totalSales(sales, QTRS) << endl;
26     return 0;
27 }
28
29 //*****
30 // Definition of getSales. This function uses
31 // a pointer to accept *
32 // the address of an array of doubles. The
33 // function asks the user *
34 // to enter sales figures and stores them in
35 // the array. *
36
37 //*****
38 void getSales(double *arr, int size)
39 {
40     for (int count = 0; count < size; count++)
41     {
42         cout << "Enter the sales figure for
43         quarter ";
44         cout << (count + 1) << ": ";

```

```

39         cin >> arr[count];
40     }
41 }
42
43
44 //*****
45 // Definition of totalSales. This function
46 // uses a pointer to *
47 // accept the address of an array. The
48 // function returns the total *
49 // of the elements in the array.
50 *
51
52 //*****
53 //*****
54 double totalSales(double *arr, int size)
55 {
56     double sum = 0.0;
57
58     for (int count = 0; count < size; count++)
59     {
60         sum += *arr;
61         arr++;
62     }
63     return sum;
64 }

```

## Program Output with Example Input Shown in Bold

```
Enter the sales figure for quarter 1:  
10263.98 Enter  
Enter the sales figure for quarter 2:  
12369.69 Enter  
Enter the sales figure for quarter 3:  
11542.13 Enter  
Enter the sales figure for quarter 4:  
14792.06 Enter  
The total sales for the year are $48967.86
```

Notice in the `getSales` function in [Program 9-12](#), even though the parameter `arr` is defined as a pointer, subscript notation is used in the `cin` statement in line 39:

```
cin >> arr[count];
```

In the `totalSales` function, `arr` is used with the indirection operator in line 54:

```
sum += *arr;
```

And in line 55, the address in `arr` is incremented to point to the next element:

```
arr++;
```



## Note:

The two previous statements could be combined into the following statement:

```
sum += *arr++;
```

The `*` operator will first dereference `arr`, then the `++` operator will increment the address in `arr`.

# Pointers to Constants

You have seen how an item's address can be passed into a pointer parameter, and how the pointer can be used to modify the item that was passed as an argument. Sometimes it is necessary to pass the address of a `const` item into a pointer. When this is the case, the pointer must be defined as a pointer to a `const` item. For example, consider the following array definition:

```
const int SIZE = 6;
const double payRates[SIZE] = { 18.55, 17.45,
                                12.85, 14.97,
                                10.35, 18.89 };
```

In this code, `payRates` is an array of `const double`s. This means each element in the array is a `const double`, and the compiler will not allow us to write code that changes the array's contents. If we want to pass the `payRates` array into a pointer parameter, the parameter must be declared as a pointer to `const double`. The following function shows such an example:

```

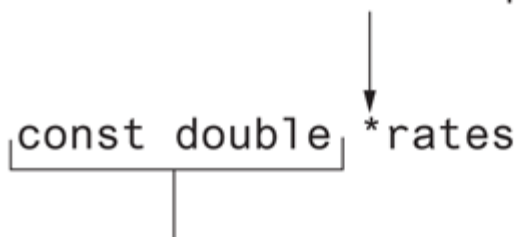
void displayPayRates(const double *rates, int size)
{
    // Set numeric output formatting.
    cout << setprecision(2) << fixed << showpoint;
    // Display all the pay rates.
    for (int count = 0; count < size; count++)
    {
        cout << "Pay rate for employee " << (count + 1)
            << " is $" << *(rates + count) << endl;
    }
}

```

In the function header, notice the `rates` parameter is defined as a pointer to `const double`. It should be noted the word `const` is applied to the thing that `rates` points to, not `rates` itself. This is illustrated in [Figure 9-8](#).

**Figure 9-8** `rates` is a pointer to `const double`

The asterisk indicates that `rates` is a pointer.




This is what `rates` points to.



Because `rates` is a pointer to a `const`, the compiler will not allow us to write code that changes the thing that `rates` points to.

In passing the address of a constant into a pointer variable, the variable must be defined as a pointer to a constant. If the word `const` had been left out of the definition of the `rates` parameter, a compiler error would have resulted.

## *Passing a Nonconstant Argument into a Pointer to a Constant*

Although a constant's address can be passed only to a pointer to `const`, a pointer to `const` can also receive the address of a nonconstant item. For example, look at [Program 9-13](#) .

## Program 9-13

```
1 // This program demonstrates a pointer to
const parameter
2 #include <iostream>
3 using namespace std;
4
5 void displayValues(const int *, int);
6
7 int main()
8 {
9     // Array sizes
10    const int SIZE = 6;
11
12    // Define an array of const ints.
13    const int array1[SIZE] = { 1, 2, 3, 4, 5,
14    6 };
15
16    // Define an array of nonconst ints.
17    int array2[SIZE] = { 2, 4, 6, 8, 10, 12 };
18
19    // Display the contents of the const
array.
20    displayValues(array1, SIZE);
21
```

```
21     // Display the contents of the nonconst
array.
22     displayValues(array2, SIZE);
23     return 0;
24 }
25
26
27 //*****
***
27 // The displayValues function uses a pointer
to *
28 // parameter to display the contents of an
array. *
29
30 //*****
***
30
31 void displayValues(const int *numbers, int
size)
32 {
33     // Display all the values.
34     for (int count = 0; count < size; count++)
35     {
36         cout << *(numbers + count) << " ";
37     }
38     cout << endl;
39 }
```

## Program Output

```
1 2 3 4 5 6
2 4 6 8 10 12
```



### Note:

When you are writing a function that uses a pointer parameter, and the function is not intended to change the data the parameter points to, it is always a good idea to make the parameter a pointer to `const`. Not only will this protect you from writing code in the function that accidentally changes the argument, but the function will be able to accept the addresses of both constant and nonconstant arguments.


# Constant Pointers

In the previous section, we discussed pointers to `const`, that is, pointers that point to `const` data. You can also use the `const` key word to define a constant pointer. Here are the differences between a pointer to `const` and a `const` pointer:

- A pointer to `const` points to a constant item. The data that the pointer points to cannot change, but the pointer itself can change.
- With a `const` pointer, it is the pointer itself that is constant. Once the pointer is initialized with an address, it cannot point to anything else.

The following code shows an example of a `const` pointer:

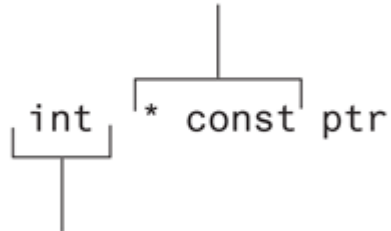
```
int value = 22;  
int * const ptr = &value;
```

Notice in the definition of `ptr`, the word `const` appears after the asterisk. This means that `ptr` is a `const` pointer. This is illustrated in [Figure 9-9](#) . In the code, `ptr` is initialized with the address of the `value` variable. Because `ptr` is a constant pointer, a compiler error will result if we write code that makes `ptr` point to anything else. An error will not result, however, if we use `ptr` to change the

contents of `value`. This is because `value` is not constant, and `ptr` is not a pointer to `const`.

**Figure 9-9** `ptr` is a `const` pointer to `int`

\* `const` indicates that `ptr` is a constant pointer.



This is what `ptr` points to.

Constant pointers must be initialized with a starting value, as shown in the previous example code. If a constant pointer is used as a function parameter, the parameter will be initialized with the address that is passed as an argument into it, and cannot be changed to point to anything else while the function is executing. Here is an example that attempts to violate this rule:

```
void setToZero(int * const ptr)
{
    ptr = 0; // ERROR!! Cannot change the contents of ptr.
}
```

This function's parameter, `ptr`, is a `const` pointer. It will not compile because we cannot have code in the function that changes the contents of `ptr`. However, `ptr` does not point to a `const`, so we

can have code that changes the data that `ptr` points to. Here is an example of the function that will compile:

```
void setToZero(int * const ptr)
{
    *ptr = 0;
}
```

Although the parameter is `const` pointer, we can call the function multiple times with different arguments. The following code will successfully pass the addresses of `x`, `y`, and `z` to the `setToZero` function:

```
int x, y, z;
// Set x, y, and z to 0.
setToZero(&x);
setToZero(&y);
setToZero(&z);
```



# Constant Pointers to Constants

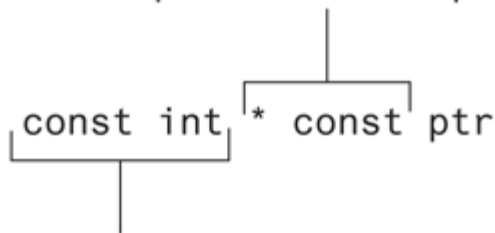
So far, when using `const` with pointers, we've seen pointers to constants and we've seen constant pointers. You can also have constant pointers to constants. For example, look at the following code:

```
int value = 22;  
const int * const ptr = &value;
```

In this code, `ptr` is a `const` pointer to a `const int`. Notice the word `const` appears before `int`, indicating that `ptr` points to a `const int`, and it appears after the asterisk, indicating that `ptr` is a constant pointer. This is illustrated in [Figure 9-10](#).


**Figure 9-10** `ptr` is a `const` pointer to `const int`

\* `const` indicates that  
`ptr` is a constant pointer.



This is what `ptr` points to.

In the code, `ptr` is initialized with the address of `value`. Because `ptr` is a `const` pointer, we cannot write code that makes `ptr` point

to anything else. Because `ptr` is a pointer to `const`, we cannot use it to change the contents of `value`. The following code shows one more example of a `const` pointer to a `const`. This is another version of the `displayValues` function in [Program 9-13](#) .

```
void displayValues(const int * const numbers, int size)
{
    // Display all the values.
    for (int count = 0; count < size; count++)
    {
        cout << *(numbers + count) << " ";
    }
    cout << endl;
}
```

In this code, the parameter `numbers` is a `const` pointer to a `const int`. Although we can call the function with different arguments, the function itself cannot change what `numbers` points to, and it cannot use `numbers` to change the contents of an argument.

## 9.8 Dynamic Memory Allocation

### **Concept:**

Variables may be created and destroyed while a program is running.

As long as you know how many variables you will need during the execution of a program, you can define those variables up front. For example, a program to calculate the area of a rectangle will need three variables: one for the rectangle's length, one for the rectangle's width, and one to hold the area. If you are writing a program to compute the payroll for 30 employees, you'll probably create an array of 30 elements to hold the amount of pay for each person.

But what about those times when you don't know how many variables you need? For instance, suppose you want to write a test-averaging program that will average any number of tests. Obviously the program would be very versatile, but how do you store the individual test scores in memory if you don't know how many variables to define? Quite simply, you allow the program to create its own variables "on the fly." This is called *dynamic memory allocation*, and is only possible through the use of pointers.

To dynamically allocate memory means that a program, while running, asks the computer to set aside a chunk of unused memory large enough to hold a variable of a specific data type. Let's say a program needs to create an integer variable. It will make a request to the computer that it allocate enough bytes to store an `int`. When the computer fills this request, it finds and sets aside a chunk of unused memory large enough for the variable. It then gives the program the starting address of the chunk of memory. The program can access the newly allocated memory only through its address, so a pointer is required to use those bytes.

The way a C++ program requests dynamically allocated memory is through the `new` operator. Assume a program has a pointer to an `int` defined as

```
int *iptr = nullptr;
```

Here is an example of how this pointer may be used with the `new` operator:

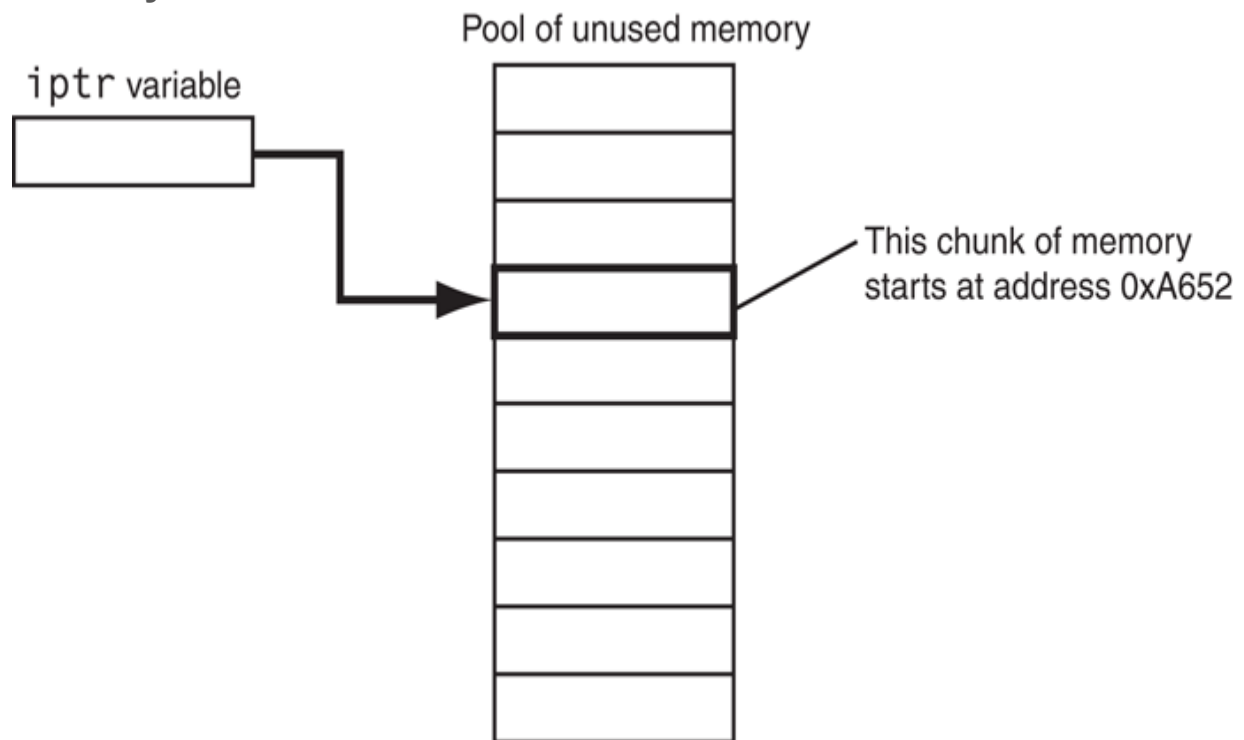
```
iptr = new int;
```

This statement is requesting that the computer allocate enough memory for a new `int` variable. The operand of the `new` operator is the data type of the variable being created. Once the statement

executes, `iptr` will contain the address of the newly allocated memory. This is illustrated in **Figure 9-11**. A value may be stored in this new variable by dereferencing the pointer:

```
*iptr = 25;
```

**Figure 9-11** `iptr` points to a chunk of dynamically allocated memory



Any other operation may be performed on the new variable by simply using the dereferenced pointer. Here are some example statements:

```
cout << *iptr;    // Display the contents of the new variable.  
cin >> *iptr;    // Let the user input a value.  
total += *iptr;  // Use the new variable in a computation.
```

Although the statements above illustrate the use of the `new` operator, there's little purpose in dynamically allocating a single variable. A more practical use of the `new` operator is to dynamically create an array. Here is an example of how a 100-element array of integers may be allocated:


```
iptr = new int[100];
```

Once the array is created, the pointer may be used with subscript notation to access it. For instance, the following loop could be used to store the value 1 in each element:

```
for (int count = 0; count < 100; count++)  
    iptr[count] = 1;
```



## Dynamically Allocating an Array

But what if there isn't enough free memory to accommodate the request? What if the program asks for a chunk large enough to hold a 100,000-element array of `float`s, and that much memory isn't available? When memory cannot be dynamically allocated, C++ throws an exception and terminates the program. *Throwing an exception* means the program signals that an error has occurred. You will learn more about exceptions in [Chapter 16](#) .

When a program is finished using a dynamically allocated chunk of memory, it should release it for future use. The `delete` operator is used to free memory that was allocated with `new`. Here is an example of how `delete` is used to free a single variable, pointed to by `iptr`:

```
delete iptr;
```

If `iptr` points to a dynamically allocated array, the `[]` symbol must be placed between `delete` and `iptr`:

```
delete [] iptr;
```

Failure to release dynamically allocated memory can cause a program to have a *memory leak*. For example, suppose the following `grabMemory` function is in a program:

```
void grabMemory()
{
    const int SIZE = 100;
    // Allocate space for a 100-element
    // array of integers.
    int *iptr = new int[SIZE];
    // The function ends without deleting the memory!
}
```


Notice the function dynamically allocates a 100-element `int` array and assigns its address to the `iptr` pointer variable. But then, the function ends without deleting the memory. Once the function has ended, the `iptr` pointer variable no longer exists. As a result, the program does not have a pointer to the dynamically allocated memory; therefore, the memory cannot be accessed or deleted. It will sit unused as long as the program is running.





## Warning!

Only use pointers with `delete` that were previously used with `new`. If you use a pointer with `delete` that does not reference dynamically allocated memory, unexpected problems could result!

**Program 9-14**  demonstrates the use of `new` and `delete`. It asks for sales amounts for any number of days. The amounts are stored in a dynamically allocated array, then totaled and averaged.

## Program 9-14

```
1 // This program totals and averages the sales
amounts for any
2 // number of days. The amounts are stored in a
dynamically
3 // allocated array.
4 #include <iostream>
5 #include <iomanip>
6 using namespace std;
7
8 int main()
9 {
10     double *sales = nullptr, // To dynamically
allocate an array
11         total = 0.0,        // Accumulator
12         average;           // To hold
average sales
13     int numDays,          // To hold the
number of days of sales
14         count;           // Counter
variable
15
16     // Get the number of days of sales.
17     cout << "How many days of sales amounts do
```

```
you wish ";
18     cout << "to process? ";
19     cin >> numDays;
20
21     // Dynamically allocate an array large
enough to hold
22     // that many days of sales amounts.
23     sales = new double[numDays];
24
25     // Get the sales amounts for each day.
26     cout << "Enter the sales amounts
below.\n";
27     for (count = 0; count < numDays; count++)
28     {
29         cout << "Day " << (count + 1) << ": ";
30         cin >> sales[count];
31     }
32
33     // Calculate the total sales
34     for (count = 0; count < numDays; count++)
35     {
36         total += sales[count];
37     }
38
39     // Calculate the average sales per day
40     average = total / numDays;
41
```

```
42     // Display the results
43     cout << fixed << showpoint <<
setprecision(2);
44     cout << "\n\nTotal Sales: $" << total <<
endl;
45     cout << "Average Sales: $" << average <<
endl;
46
47     // Free dynamically allocated memory
48     delete [] sales;
49     sales = nullptr;    // Make sales a null
pointer.
50
51     return 0;
52 }
```

**Program Output with Example Input Shown in Bold**

```
How many days of sales amounts do you wish  
to process? 5 Enter
```

```
Enter the sales amounts below.
```

```
Day 1: 898.63 Enter
```

```
Day 2: 652.32 Enter
```

```
Day 3: 741.85 Enter
```

```
Day 4: 852.96 Enter
```

```
Day 5: 921.37 Enter
```

```
Total Sales: $4067.13
```

```
Average Sales: $813.43
```

The statement in line 23 dynamically allocates memory for an array of `double`s, using the value in `numDays` as the number of elements. The `new` operator returns the starting address of the chunk of memory, which is assigned to the `sales` pointer variable. The `sales` variable is then used throughout the program to store the sales amounts in the array and perform the necessary calculations. In line 48, the `delete` operator is used to free the allocated memory.

Notice in line 49, the value `nullptr` is assigned to the `sales` pointer. It is a good practice to set a pointer variable to `nullptr` after using `delete` on it. First, it prevents code from inadvertently using

the pointer to access the area of memory that was freed. Second, it prevents errors from occurring if `delete` is accidentally called on the pointer again. The `delete` operator is designed to have no effect when used on a null pointer.

## 9.9 Returning Pointers from Functions

### Concept:

Functions can return pointers, but you must be sure the item the pointer references still exists.

Like any other data type, functions may return pointers. For example, the following function locates the null terminator that appears at the end of a string (such as a string literal) and returns a pointer to it:

```
char *findNull(char *str)
{
    char *ptr = str;
    while (*ptr != '\0')
        ptr++;
    return ptr;
}
```

The `char *` return type in the function header indicates the function returns a pointer to a `char`.

```
char *findNull(char *str)
```

When writing functions that return pointers, you should take care not to create elusive bugs. For instance, see if you can determine what's wrong with the following function:

```
string *getFullName()
{
    string fullName[3];
    cout << "Enter your first name: ";
    getline(cin, fullName[0]);
    cout << "Enter your middle name: ";
    getline(cin, fullName[1]);
    cout << "Enter your last name: ";
    getline(cin, fullName[2]);
    return fullName;
}
```

The problem, of course, is that the function returns a pointer to an array that no longer exists. Because the `fullName` array is defined locally, it is destroyed when the function terminates. Attempting to use the pointer will result in erroneous and unpredictable results.



You should return a pointer from a function only if it is:

- A pointer to an item that was passed into the function as an argument.
- A pointer to a dynamically allocated chunk of memory.

For instance, the following function is acceptable:


```
string *getFullName(string fullName[])  
{  
    cout << "Enter your first name: ";  
    getline(cin, fullName[0]);  
    cout << "Enter your middle name: ";  
    getline(cin, fullName[1]);  
    cout << "Enter your last name: ";  
    getline(cin, fullName[2]);  
    return fullName;  
}
```

This function accepts a pointer to the memory location where the user's input is to be stored. Because the pointer references a memory location that was valid prior to the function being called, it is safe to return a pointer to the same location. Here is another acceptable function:

```
string *getFullName()
{
    string *fullName = new string[3];

    cout << "Enter your first name: ";
    getline(cin, fullName[0]);
    cout << "Enter your middle name: ";
    getline(cin, fullName[1]);
    cout << "Enter your last name: ";
    getline(cin, fullName[2]);
    return fullName;
}
```

This function uses the `new` operator to allocate a section of memory. This memory will remain allocated until the `delete` operator is used or the program ends, so it's safe to return a pointer to it.

**Program 9-15**  shows another example. This program uses a function, `getRandomNumbers`, to get a pointer to an array of random numbers. The function accepts an integer argument that is the number of random numbers in the array. The function dynamically allocates an array, uses the system clock to seed the random number generator, populates the array with random values, then returns a pointer to the array.

## Program 9-15

```
1 // This program demonstrates a function that
returns
2 // a pointer.
3 #include <iostream>
4 #include <cstdlib> // For rand and srand
5 #include <ctime> // For the time function
6 using namespace std;
7
8 // Function prototype
9 int *getRandomNumbers(int);
10
11 int main()
12 {
13     int *numbers = nullptr; // To point to
the numbers
14
15     // Get an array of five random numbers.
16     numbers = getRandomNumbers(5);
17
18     // Display the numbers.
19     for (int count = 0; count < 5; count++)
20         cout << numbers[count] << endl;
21
```

```

22     // Free the memory.
23     delete [] numbers;
24     numbers = nullptr;
25     return 0;
26 }
27
28
29 //*****
***
29 // The getRandomNumbers function returns a
pointer *
30 // to an array of random integers. The
parameter *
31 // indicates the number of numbers requested.
*
32
33 //*****
***
33
34 int *getRandomNumbers(int num)
35 {
36     int *arr = nullptr; // Array to hold the
numbers
37
38     // Return a null pointer if num is zero or
negative.
39     if (num <= 0)

```

```
40     return nullptr;
41
42     // Dynamically allocate the array.
43     arr = new int[num];
44
45     // Seed the random number generator by
passing
46     // the return value of time(0) to srand.
47     srand( time(0) );
48
49     // Populate the array with random numbers.
50     for (int count = 0; count < num; count++)
51         arr[count] = rand();
52
53     // Return a pointer to the array.
54     return arr;
55 }
```

## Program Output

2712

9656

24493

12483

7633



In the

## Spotlight:


Suppose you are developing a program that works with arrays of integers, and you find that you frequently need to duplicate the arrays. Rather than rewriting the array-duplicating code each time you need it, you decide to write a function that accepts an array and its size as arguments, creates a new array that is a copy of the argument array, and returns a pointer to the new array. The function will work as follows:

*Accept an array and its size as arguments.*

*Dynamically allocate a new array that is the same size as the argument array.*

*Copy the elements of the argument array to the new array.*

*Return a pointer to the new array.*

**Program 9-16**  demonstrates the function, which is named `duplicateArray`.

## Program 9-16

```
1 // This program uses a function to
duplicate
2 // an int array of any size.
3 #include <iostream>
4 using namespace std;
5
6 // Function prototype
7 int *duplicateArray(const int *, int);
8 void displayArray(const int[], int);
9
10 int main()
11 {
12     // Define constants for the array
sizes.
13     const int SIZE1 = 5, SIZE2 = 7,
SIZE3 = 10;
14
15     // Define three arrays of different
sizes.
16     int array1[SIZE1] = { 100, 200,
300, 400, 500 };
17     int array2[SIZE2] = { 10, 20, 30,
```



```
40, 50, 60, 70 };
```

```
18     int array3[SIZE3] = { 1, 2, 3, 4,
19     5, 6, 7, 8, 9, 10 };
20     // Define three pointers for the
duplicate arrays.
21     int *dup1 = nullptr, *dup2 =
nullptr, *dup3 = nullptr;
22
23     // Duplicate the arrays.
24     dup1 = duplicateArray(array1,
SIZE1);
25     dup2 = duplicateArray(array2,
SIZE2);
26     dup3 = duplicateArray(array3,
SIZE3);
27
28     // Display the original arrays.
29     cout << "Here are the original
array contents:\n";
30     displayArray(array1, SIZE1);
31     displayArray(array2, SIZE2);
32     displayArray(array3, SIZE3);
33
34     // Display the new arrays.
35     cout << "\nHere are the duplicate
arrays: \n";
```

```

36     displayArray(dup1, SIZE1);
37     displayArray(dup2, SIZE2);
38     displayArray(dup3, SIZE3);
39
40     // Free the dynamically allocated
memory and
41     // set the pointers to 0.
42     delete [] dup1;
43     delete [] dup2;
44     delete [] dup3;
45     dup1 = nullptr;
46     dup2 = nullptr;
47     dup3 = nullptr;
48     return 0;
49 }
50
//*****
*****
51 // The duplicateArray function
accepts an int array *
52 // and an int that indicates the
array's size. The *
53 // function creates a new array that
is a duplicate *
54 // of the argument array and returns
a pointer to the *
55 // new array. If an invalid size is

```

```

passed, the *
56 // function returns a null pointer.
*
57
//*****
*****
58
59 int *duplicateArray(const int *arr,
int size)
60 {
61     int *newArray = nullptr;
62
63     // Validate the size. If 0 or a
negative
64     // number was passed, return a
null pointer.
65     if (size <= 0)
66         return nullptr;
67
68     // Allocate a new array.
69     newArray = new int[size];
70
71     // Copy the array's contents to
the
72     // new array.
73     for (int index = 0; index < size;
index++)

```

```
74     newArray[index] = arr[index];
75
76     // Return a pointer to the new
array.
77     return newArray;
78 }
79
80
//*****
*****
81 // The displayArray function accepts
an int array *
82 // and its size as arguments and
displays the *
83 // contents of the array.
*
84
//*****
*****
85
86 void displayArray(const int arr[],
int size)
87 {
88     for (int index = 0; index < size;
index++)
89         cout << arr[index] << " ";
```

```
90     cout << endl;  
91 }
```

## Program Output

```
Here are the original array contents:  
100 200 300 400 500  
10 20 30 40 50 60 70  
1 2 3 4 5 6 7 8 9 10
```

```
Here are the duplicate arrays:  
100 200 300 400 500  
10 20 30 40 50 60 70  
1 2 3 4 5 6 7 8 9 10
```

The `duplicateArray` function appears in lines 59 and 78. The `if` statement in lines 65 and 66 validates that `size` contains a valid array size. If `size` is 0 or less, the function immediately returns `nullptr` to indicate that an invalid size was passed.

Line 69 allocates a new array and assigns its address to the `newArray` pointer. Then, the loop in lines 73 and 74 copies the elements of the `arr` parameter to the new array. Then,

the `return` statement in line 77 returns a pointer to the new array.



# Checkpoint

9.9 Assuming `arr` is an array of `int`s, will each of the following program segments display “True” or “False”?

A.

```
if (arr < &arr[1])
    cout << "True";
else
    cout << "False";
```

B.

```
if (&arr[4] < &arr[1])
    cout << "True";
else
    cout << "False";
```

C.

```
if (arr != &arr[2])
    cout << "True";
else
    cout << "False";
```

D.

```
if (arr != &arr[0])
    cout << "True";
else
    cout << "False";
```

9.10 Give an example of the proper way to call the following function:

```
void makeNegative(int *val)
{
    if (*val > 0)
        *val = -(*val);
}
```

9.11 Complete the following program skeleton. When finished, the program will ask the user for a length (in inches), then convert that value to centimeters, and display the result. You are to write the function `convert`. (Note: 1 inch = 2.54 cm. Do not modify function `main`.)



```

#include <iostream>
#include <iomanip>
using namespace std;

// Write your function prototype here.

int main()
{
    double measurement;

    cout << "Enter a length in inches, and I will
convert\n";
    cout << "it to centimeters: ";
    cin >> measurement;
    convert(&measurement);
    cout << fixed << setprecision(4);
    cout << "Value in centimeters: " << measurement <<
endl;
    return 0;
}

//
// Write the function convert here.
//

```

9.12 Look at the following array definition:

```
const int numbers[SIZE] = { 18, 17, 12, 14 };
```

Suppose we want to pass the array to the function `processArray` in the following manner:

```
processArray(numbers, SIZE);
```

Which of the following function headers is the correct one for the `processArray` function?

- A. `void processArray(const int *arr, int size)`
- B. `void processArray(int * const arr, int size)`

9.13 Assume `ip` is a pointer to an `int`. Write a statement that will dynamically allocate an integer variable and store its address in `ip`. Write a statement that will free the memory allocated in the statement you wrote above.

9.14 Assume `ip` is a pointer to an `int`. Then, write a statement that will dynamically allocate an array of 500 integers and store its address in `ip`. Write a statement that will free the memory allocated in the statement you just wrote.

9.15 What is a null pointer?

9.16 Give an example of a function that correctly returns a pointer.

9.17 Give an example of a function that incorrectly returns a pointer.

## 9.10 Using Smart Pointers to Avoid Memory Leaks

### Concept:

C++ 11 introduces smart pointers, objects that work like pointers, but have the ability to automatically delete dynamically allocated memory that is no longer being used.

**11** In C++ 11, you can use *smart pointers* to dynamically allocate memory and not worry about deleting the memory when you are finished using it. A smart pointer automatically deletes a chunk of dynamically allocated memory when the memory is no longer being used. This helps to prevent memory leaks from occurring.

C++ 11 provides three types of smart pointer: `unique_ptr`, `shared_ptr`, and `weak_ptr`.

These smart pointers are described in [Table 9-1](#) .

### Table 9-1 Smart Pointer Types

To use any of the smart pointers, you must `#include` the `<memory>` header file with the following directive:

```
#include <memory>
```

In this book, we introduce `unique_ptr`. The syntax for defining a `unique_ptr` is somewhat different from the syntax used in defining a regular pointer. Here is an example:

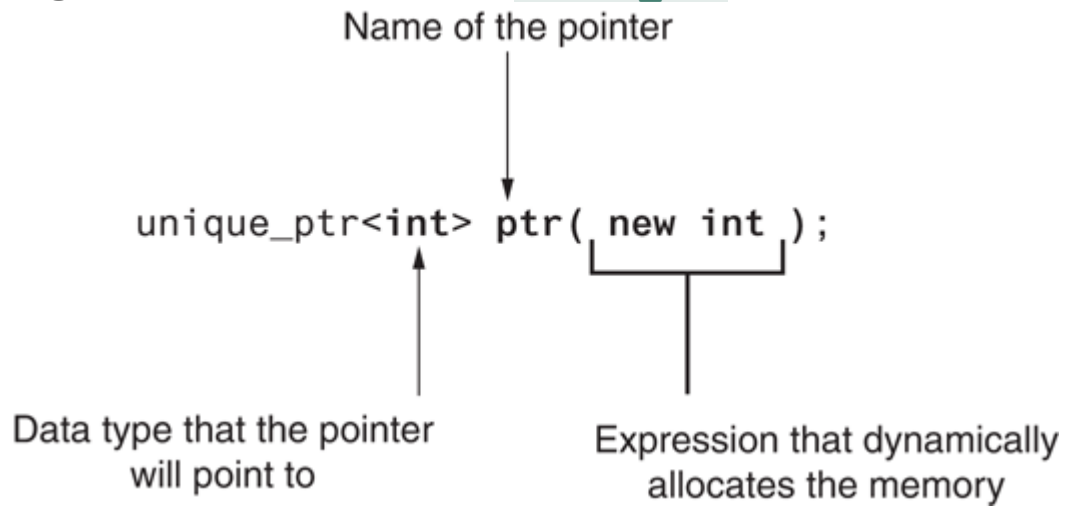
```
unique_ptr<int> ptr( new int );
```

This statement defines a `unique_ptr` named `ptr` that points to a dynamically allocated `int`. Here are some details about the statement:

- The notation `<int>` that appears immediately after `unique_ptr` indicates that the pointer can point to an `int`.
- The name of the pointer is `ptr`.
- The expression `new int` that appears inside the parentheses allocates a chunk of memory to hold an `int`. The address of the chunk of memory will be assigned to the `ptr` pointer.

**Figure 9-12**  shows the different parts of the definition statement.

Figure 9-12 Definition of a `unique_ptr`



Once you have defined a `unique_ptr`, you can use it in a similar way as a regular pointer. This is demonstrated in [Program 9-17](#).


## Program 9-17

```
1 // This program demonstrates a unique_ptr.
2 #include <iostream>
3 #include <memory>
4 using namespace std;
5
6 int main()
7 {
8     // Define a unique_ptr smart pointer,
pointing
9     // to a dynamically allocated int.
10    unique_ptr<int> ptr( new int );
11
12    // Assign 99 to the dynamically allocated
int.
13    *ptr = 99;
14
15    // Display the value of the dynamically
allocated int.
16    cout << *ptr << endl;
17    return 0;
18 }
```

## Program Output

```
99
```

In line 3, we have a `#include` directive for the `<memory>` header file. Line 10 defines a `unique_ptr` named `ptr`, pointing to a dynamically allocated `int`. Line 13 assigns the value 99 to the dynamically allocated `int`. Notice the indirection operator (`*`) is used with the `unique_ptr`, just as if it were a regular pointer. Line 16 displays the value stored in the dynamically allocated `int`, once again using the indirection operator with the `unique_ptr`. Notice there is no `delete` statement to free the dynamically allocated memory. It is unnecessary to delete the memory, because the smart pointer will automatically delete it as the function comes to an end.

**Program 9-17**  demonstrates a `unique_ptr`, but it isn't very practical. Dynamically allocating an array is more useful than allocating a single integer. The following code shows an example of how to use a `unique_ptr` to dynamically allocate an array of integers:


```
const int SIZE = 100;
unique_ptr<int[]> ptr( new int[SIZE] );
```

The first statement defines an `int` constant named `SIZE`, set to the value 100. The second statement defines a `unique_ptr` named `ptr` that points to a dynamically allocated array of 100 `int`s. Notice the following things about the definition statement:

- Following `unique_ptr`, the notation `<int[]>` indicates that the pointer will point to an array of `int`s.
- The expression inside the parentheses, `new int[SIZE]`, allocates an array of `int`s.

The address of the dynamically allocated array of `int`s will be assigned to the `ptr` pointer. After the definition statement, you can use the `[]` operator with subscripts to access the array elements. Here is an example:

```
ptr[0] = 99;
cout << ptr[0] << endl;
```

The first statement assigns the value 99 to `ptr[0]`, and the second statement displays the value of `ptr[0]`. **Program 9-18**  gives a more complete demonstration.



## Program 9-18

```
1 // This program demonstrates a unique_ptr
pointing
2 // to a dynamically allocated array of
integers.
3 #include <iostream>
4 #include <memory>
5 using namespace std;
6
7 int main()
8 {
9     int max; // Max size of the array
10
11     // Get the number of values to store.
12     cout << "How many numbers do you want to
enter? ";
13     cin >> max;
14
15     // Define a unique_ptr smart pointer,
pointing
16     // to a dynamically allocated array of
ints.
17     unique_ptr<int[]> ptr( new int[max]);
18
```

```
19     // Get values for the array.
20     for (int index = 0; index < max; index++)
21     {
22         cout << "Enter an integer number: ";
23         cin >> ptr[index];
24     }
25
26     // Display the values in the array.
27     cout << "Here are the values you
entered:\n";
28     for (int index = 0; index < max; index++)
29         cout << ptr[index] << endl;
30
31     return 0;
32 }
```

**Program Output with Example Input Shown in Bold**

```
How many numbers do you want to enter? 5
Enter
Enter an integer number: 1 Enter
Enter an integer number: 2 Enter
Enter an integer number: 3 Enter
Enter an integer number: 4 Enter
Enter an integer number: 5 Enter
Here are the values you entered:
1
2
3
4
5
```

You can define an uninitialized `unique_ptr`, then assign it a value in a later statement. Here is an example:

```
unique_ptr<int> ptr;
ptr = unique_ptr<int>(new int);
```

Smart pointers support the same `*` and `->` dereferencing operators as regular pointers, but smart pointers do not support pointer arithmetic. The following code will result in a compile-time error:

```
unique_ptr<int[]> ptr( new int[max]);  
ptr++; // ERROR!
```

## 9.11 Focus on Problem Solving and Program Design: A Case Study

### Concept:

This case study demonstrates how an array of pointers can be used to display the contents of a second array in sorted order, without sorting the `second` array.

The United Cause, a charitable relief agency, solicits donations from businesses. The local United Cause office received the following donations from the employees of CK Graphics, Inc.:

```
$5, $100, $5, $25, $10, $5, $25, $5, $5, $100, $10, $15, $10, $5, $10
```

The donations were received in the order they appear. The United Cause manager has asked you to write a program that displays the donations in ascending order, as well as in their original order.

## Variables

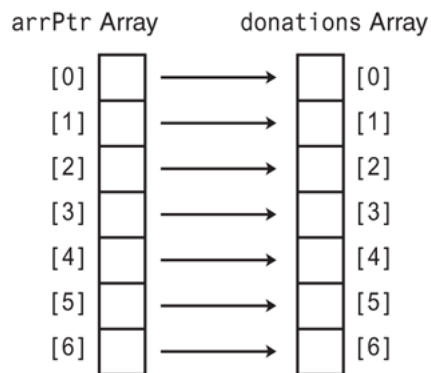
[Table 9-2](#) shows the major variables needed.

**Table 9-2 Variables**

# Programming Strategy

In this program, the `donations` array will contain the donations in the order they were received. The elements of the `arrPtr` array are pointers to integers. They will point to the elements of the `donations` array, as illustrated in [Figure 9-13](#).

**Figure 9-13 Relationship between the arrays**

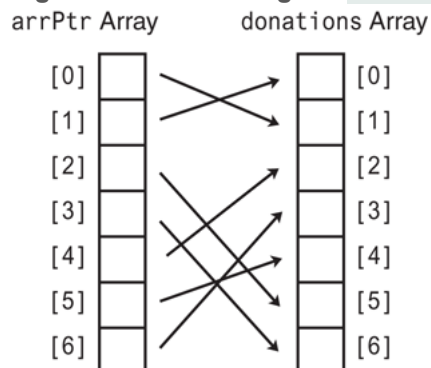


The `arrPtr` array will initially be set up to point to the elements of the `donations` array in their natural order. In other words, `arrPtr[0]` will point to `donations[0]`, `arrPtr[1]` will point to `donations[1]`, and so forth. In that arrangement, the following statement would cause the contents of `donations[5]` to be displayed:

```
cout << *(arrPtr[5]) << endl;
```

After the `arrPtr` array is sorted, however, `arrPtr[0]` will point to the smallest element of `donations`, `arrPtr[1]` will point to the next-to-smallest element of `donations`, and so forth. This is illustrated in [Figure 9-14](#).

**Figure 9-14 Accessing the `donations` array elements in sorted order**



This technique gives us access to the elements of the `donations` array in a sorted order without actually disturbing the contents of the `donations` array itself.

## Functions

The program will consist of the functions listed in [Table 9-3](#).

**Table 9-3 Functions**

### Function `main`

In addition to containing the variable definitions, function `main` sets up the `arrPtr` array to point to the elements of the `donations` array. Then, the function `arrSelectSort` is called to sort the elements of `arrPtr`. Last, the functions `showArrPtr` and `showArray` are called to display the donations. Here is the pseudocode for `main`'s executable statements:

```
For count is set to the values 0 through the number of donations
  Set arrPtr[count] to the address of donations[count].
End For
Call arrSelectSort
Call showArrPtr
Call showArray
```

## The `arrSelectSort` Function

The `arrSelectSort` function is a modified version of the selection sort algorithm shown in [Chapter 8](#). The only difference is that `arr` is now an array of pointers. Instead of sorting on the contents of `arr`'s elements, `arr` is sorted on the contents of what its elements point to. Here is the pseudocode:

```
For startScan is set to the values 0 up to (but not including) the
    next-to-last subscript in arr
    Set index variable to startScan
    Set minIndex variable to startScan
    Set minElem pointer to arr[startScan]
    For index variable is set to the values from (startScan + 1) through
        the last subscript in arr
        If *(arr[index]) is less than *minElem
            Set minElem to arr[index]
            Set minIndex to index
        End If
    End For
    Set arr[minIndex] to arr[startScan]
    Set arr[startScan] to minElem
End For
```

## The `showArrPtr` Function

The `showArrPtr` function accepts an array of pointers as its argument. It displays the values pointed to by the elements of the array. Here is its pseudocode:

```
For every element in the arr
    Dereference the element and display what it points to
End For.
```




# The `showArray` Function

The `showArray` function simply displays the contents of `arr` sequentially. Here is its pseudocode:

```
For every element in arr
  Display the element's contents
End For.
```

# The Entire Program

**Program 9-19**  shows the entire program's source code.

## Program 9-19

```
1 // This program shows the donations made to the United Cause
2 // by the employees of CK Graphics, Inc. It displays
3 // the donations in order from lowest to highest
4 // and in the original order they were received.
5 #include <iostream>
6 using namespace std;
7
8 // Function prototypes
9 void arrSelectSort(int *[], int);
10 void showArray(const int [], int);
11 void showArrPtr(int *[], int);
12
13 int main()
14 {
15     const int NUM_DONATIONS = 15; // Number of donations
16
17     // An array containing the donation amounts.
18     int donations[NUM_DONATIONS] = { 5, 100, 5, 25, 10,
19                                     5, 25, 5, 5, 100,
20                                     10, 15, 10, 5, 10 };
21
22     // An array of pointers to int.
23     int *arrPtr[NUM_DONATIONS] = { nullptr, nullptr, nullptr, nullptr, nullptr,
24                                   nullptr, nullptr, nullptr, nullptr, nullptr,
25                                   nullptr, nullptr, nullptr, nullptr, nullptr};
26
27     // Each element of arrPtr is a pointer to int. Make each
28     // element point to an element in the donations array.
29     for (int count = 0; count < NUM_DONATIONS; count++)
30         arrPtr[count] = &donations[count];
31
32     // Sort the elements of the array of pointers.
33     arrSelectSort(arrPtr, NUM_DONATIONS);
34
35     // Display the donations using the array of pointers. This
36     // will display them in sorted order.
37     cout << "The donations, sorted in ascending order, are: \n";
```

```

38     showArrPtr(arrPtr, NUM_DONATIONS);
39
40     // Display the donations in their original order.
41     cout << "The donations, in their original order, are: \n";
42     showArray(donations, NUM_DONATIONS);
43     return 0;
44 }
45
46 //*****
47 // Definition of function arrSelectSort. *
48 // This function performs an ascending order selection sort on *
49 // arr, which is an array of pointers. Each element of array *
50 // points to an element of a second array. After the sort, *
51 // arr will point to the elements of the second array in *
52 // ascending order. *
53 //*****
54
55 void arrSelectSort(int *arr[], int size)
56 {
57     int startScan, minIndex;
58     int *minElem;
59
60     for (startScan = 0; startScan < (size - 1); startScan++)
61     {
62         minIndex = startScan;
63         minElem = arr[startScan];
64         for(int index = startScan + 1; index < size; index++)
65         {
66             if (*(arr[index]) < *minElem)
67             {
68                 minElem = arr[index];
69                 minIndex = index;
70             }
71         }
72         arr[minIndex] = arr[startScan];
73         arr[startScan] = minElem;
74     }
75 }
76
77 //*****
78 // Definition of function showArray. *

```

```

79 // This function displays the contents of arr. size is the *
80 // number of elements. *
81 //*****
82
83 void showArray(const int arr[], int size)
84 {
85     for (int count = 0; count < size; count++)
86         cout << arr[count] << " ";
87     cout << endl;
88 }
89
90 //*****
91 // Definition of function showArrPtr. *
92 // This function displays the contents of the array pointed to *
93 // by arr. size is the number of elements. *
94 //*****
95
96 void showArrPtr(int *arr[], int size)
97 {
98     for (int count = 0; count < size; count++)
99         cout << *(arr[count]) << " ";
100     cout << endl;
101 }

```

## Program Output

```

The donations, sorted in ascending order, are:
5 5 5 5 5 10 10 10 10 15 25 25 100 100
The donations, in their original order, are:
5 100 5 25 10 5 25 5 5 100 10 15 10 5 10

```

# Review Questions and Exercises

## Short Answer

1. What does the indirection operator do?
2. Look at the following code.

```
int x = 7;  
int *iptr = &x;
```

What will be displayed if you send the expression `*iptr` to `cout`? What happens if you send the expression `ptr` to `cout`?

3. So far you have learned three different uses for the `*` operator. What are they?
4. What math operations are allowed on pointers?
5. Assuming `ptr` is a pointer to an `int`, what happens when you add 4 to `ptr`?
6. Look at the following array definition.

```
int numbers[] = { 2, 4, 6, 8, 10 };
```

What will the following statement display?

```
cout << *(numbers + 3) << endl;
```

7. What is the purpose of the `new` operator?

8. What happens when a program uses the `new` operator to allocate a block of memory, but the amount of requested memory isn't available? How do programs written with older compilers handle this?
9. What is the purpose of the `delete` operator?
10. Under what circumstances can you successfully return a pointer from a function?
11. What is the difference between a pointer to a constant and a constant pointer?
12. What are two advantages of declaring a pointer parameter as a constant pointer?

# Fill-in-the-Blank

13. Each byte in memory is assigned a unique \_\_\_\_\_.
14. The \_\_\_\_\_ operator can be used to determine a variable's address.
15. \_\_\_\_\_ variables are designed to hold addresses.
16. The \_\_\_\_\_ operator can be used to work with the variable a pointer points to.
17. Array names can be used as \_\_\_\_\_, and vice versa.
18. Creating variables while a program is running is called \_\_\_\_\_.
19. The \_\_\_\_\_ operator is used to dynamically allocate memory.
20. Under older compilers, if the `new` operator cannot allocate the amount of memory requested, it returns \_\_\_\_\_.
21. A pointer that contains the address 0 is called a(n) \_\_\_\_\_ pointer.
22. When a program is finished with a chunk of dynamically allocated memory, it should free it with the \_\_\_\_\_ operator.
23. You should only use pointers with `delete` that were previously used with \_\_\_\_\_.



# Algorithm Workbench

24. Look at the following code:

```
double value = 29.7;  
double *ptr = &value;
```

Write a `cout` statement that uses the `ptr` variable to display the contents of the `value` variable.

25. Look at the following array definition:

```
int set[10];
```

Write a statement using pointer notation that stores the value 99 in `set[7]`;

26. Write code that dynamically allocates an array of 20 integers, then uses a loop to allow the user to enter values for each element of the array.

27. Assume `tempNumbers` is a pointer that points to a dynamically allocated array. Write code that releases the memory used by the array.

28. Look at the following function definition:

```
void getNumber(int &n)
{
    cout << "Enter a number: ";
    cin >> n;
}
```

In this function, the parameter `n` is a reference variable.

Rewrite the function so `n` is a pointer.

29. Write the definition of `ptr`, a pointer to a constant `int`.
30. Write the definition of `ptr`, a constant pointer to an `int`.

# True or False

31. T F Each byte of memory is assigned a unique address.
32. T F The `*` operator is used to get the address of a variable.
33. T F Pointer variables are designed to hold addresses.
34. T F The `&` symbol is called the indirection operator.
35. T F The `&` operator dereferences a pointer.
36. T F When the indirection operator is used with a pointer variable, you are actually working with the value the pointer is pointing to.
37. T F Array names cannot be dereferenced with the indirection operator.
38. T F When you add a value to a pointer, you are actually adding that number times the size of the data type referenced by the pointer.
39. T F The address operator is not needed to assign an array's address to a pointer.
40. T F You can change the address that an array name points to.
41. T F Any mathematical operation, including multiplication and division, may be performed on a pointer.
42. T F Pointers may be compared using the relational operators.
43. T F When used as function parameters, reference variables are much easier to work with than pointers.
44. T F The `new` operator dynamically allocates memory.
45. T F A pointer variable that has not been initialized is called a null pointer.
46. T F The address 0 is generally considered unusable.

47. T F n using a pointer with the `delete` operator, it is not necessary for the pointer to have been previously used with the `new` operator.

# Find the Error

Each of the following definitions and program segments has errors. Locate as many as you can.

48. `int ptr* = nullptr;`

49. `int x, *ptr = nullptr;`  
`&x = ptr;`

50. `int x, *ptr = nullptr;`  
`*ptr = &x;`

51. `int x, *ptr = nullptr;`  
`ptr = &x;`  
`ptr = 100; // Store 100 in x`  
`cout << x << endl;`

52. `int numbers[] = {10, 20, 30, 40, 50};`  
`cout << "The third element in the array is ";`  
`cout << *numbers + 3 << endl;`

53. `int values[20], *iptr = nullptr;`  
`iptr = values;`  
`iptr *= 2;`

54. `float level;`  
`int fptr = &level;`

55. `int *iptr = &ivalue;`  
`int ivalue;`

56. `void doubleVal(int val)`  
`{`  
`*val *= 2;`  
`}`

57. `int *pint = nullptr;`  
`new pint;`

58.

```
int *pint = nullptr;
pint = new int;
if (pint == nullptr)
    *pint = 100;
else
    cout << "Memory allocation error\n";
```

59.

```
int *pint = nullptr;
pint = new int[100]; // Allocate memory
```

```
    .
```

```
    .
```

*Code that processes the array.*

```
    .
```

```
    .
```

```
delete pint; // Free memory
```

60.

```
int *getNum()  
{  
    int wholeNum;  
    cout << "Enter a number: ";  
    cin >> wholeNum;  
    return &wholeNum;  
}
```

61.

```
const int arr[] = { 1, 2, 3 };  
int *ptr = arr;
```

62.

```
void doSomething(int * const ptr)  
{  
    int localArray[] = { 1, 2, 3 };  
    ptr = localArray;  
}
```



# Programming Challenges

## 1. **Array Allocator**

Write a function that dynamically allocates an array of integers. The function should accept an integer argument indicating the number of elements to allocate. The function should return a pointer to the array.

## 2. **Test Scores #1**

Write a program that dynamically allocates an array large enough to hold a user-defined number of test scores. Once all the scores are entered, the array should be passed to a function that sorts them in ascending order. Another function should be called that calculates the average score. The program should display the sorted list of scores and averages with appropriate headings. Use pointer notation rather than array notation whenever possible.

*Input Validation: Do not accept negative numbers for test scores.*

## 3. **Drop Lowest Score**

Modify Problem 2 above so the lowest test score is dropped. This score should not be included in the calculation of the average.

## 4. **Test Scores #2**

Modify the program of Programming Challenge 2 (Test Scores #1) to allow the user to enter name–score pairs. For each student taking a test, the user types the student's name

followed by the student's integer test score. Modify the sorting function so it takes an array holding the student names, and an array holding the student test scores. When the sorted list of scores is displayed, each student's name should be displayed along with his or her score. In stepping through the arrays, use pointers rather than array subscripts.

### 5. **Pointer Rewrite**

The following function uses reference variables as parameters. Rewrite the function so it uses pointers instead of reference variables, then demonstrate the function in a complete program.



### **Solving the Pointer Rewrite Problem**

```
int doSomething(int &x, int &y)
{
    int temp = x;
    x = y * 10;
    y = temp * 10;
    return x + y;
}
```

## 6. Case Study Modification #1

Modify [Program 9-19](#) (the United Cause case study program) so it can be used with any set of donations. The program should dynamically allocate the `donations` array and ask the user to input its values.

## 7. Case Study Modification #2

Modify [Program 9-19](#) (the United Cause case study program) so the `arrptr` array is sorted in descending order instead of ascending order.

## 8. Mode Function

In statistics, the *mode* of a set of values is the value that occurs most often or with the greatest frequency. Write a function that accepts as arguments the following:

- A. An array of integers
- B. An integer that indicates the number of elements in the array

The function should determine the mode of the array. That is, it should determine which value in the array occurs most

often. The mode is the value the function should return. If the array has no mode (none of the values occur more than once), the function should return  $-1$ . (Assume the array will always contain nonnegative values.)

Demonstrate your pointer prowess by using pointer notation instead of array notation in this function.

## 9. Median Function

In statistics, when a set of values is sorted in ascending or descending order, its *median* is the middle value. If the set contains an even number of values, the median is the mean, or average, of the two middle values. Write a function that accepts as arguments the following:

- A. An array of integers
- B. An integer that indicates the number of elements in the array

The function should determine the median of the array. This value should be returned as a `double`. (Assume the values in the array are already sorted.)

Demonstrate your pointer prowess by using pointer notation instead of array notation in this function.

## 10. Reverse Array

Write a function that accepts an `int` array and the array's size as arguments. The function should create a copy of the array, except that the element values should be reversed in the copy. The function should return a pointer to the new array. Demonstrate the function in a complete program.

## 11. Array Expander

Write a function that accepts an `int` array and the array's size as arguments. The function should create a new array that is twice the size of the argument array. The function should copy the contents of the argument array to the new array and initialize the unused elements of the second array with 0. The function should return a pointer to the new array.

## 12. **Element Shifter**

Write a function that accepts an `int` array and the array's size as arguments. The function should create a new array that is one element larger than the argument array. The first element of the new array should be set to 0. Element 0 of the argument array should be copied to element 1 of the new array, element 1 of the argument array should be copied to element 2 of the new array, and so forth. The function should return a pointer to the new array.

## 13. **Movie Statistics**

Write a program that can be used to gather statistical data about the number of movies college students see in a month. The program should perform the following steps:

- A. Ask the user how many students were surveyed. An array of integers with this many elements should then be dynamically allocated.
- B. Allow the user to enter the number of movies each student saw into the array.
- C. Calculate and display the average, median, and mode of the values entered. (Use the functions you wrote in Programming Challenges 8 and 9 to calculate the median and mode.)

*Input Validation: Do not accept negative numbers for input.*

---

# Chapter **10** Characters, C-Strings, and More about the `string` Class

---

## Topics

10.1 Character Testing [📄](#)

10.2 Character Case Conversion [📄](#)

10.3 C-Strings [📄](#)

10.4 Library Functions for Working with C-Strings [📄](#)

10.5 String/Numeric Conversion Functions [📄](#)

10.6 Focus on Software Engineering: Writing Your Own C-String-Handling Functions [📄](#)

10.7 More about the C++ `string` Class [📄](#)

10.8 Focus on Problem Solving and Program Design: A Case Study [📄](#)

# 10.1 Character Testing

## Concept:

The C++ library provides several functions for testing characters. To use these functions you must include the `<cctype>` header file.


The C++ library provides several functions that allow you to test the value of a character. These functions test a single `char` argument and return either `true` or `false`.<sup>\*</sup> For example, the following program segment uses the `isupper` function to determine whether the character passed as an argument is an uppercase letter. If it is, the function returns `true`. Otherwise, it returns `false`.

<sup>\*</sup>These functions actually return an `int` value. The return value is nonzero to indicate true, or zero to indicate false.





```
char letter = 'a';  
if (isupper(letter))  
    cout << "Letter is uppercase.\n";  
else  
    cout << "Letter is lowercase.\n";
```

Because the variable `letter`, in this example, contains a lowercase character, `isupper` returns `false`. The `if` statement will cause the message `"Letter is lowercase"` to be displayed.

**Table 10-1**  lists several character-testing functions. Each of these is prototyped in the `<cctype>` header file, so be sure to include that file when using the functions.

#### **Table 10-1 Character-Testing Functions in `<cctype>`**

**Program 10-1**  uses several of the functions shown in **Table 10-1** . It asks the user to input a character then displays various messages, depending upon the return value of each function.

## Program 10-1

```
1 // This program demonstrates some character-
testing functions.
2 #include <iostream>
3 #include <cctype>
4 using namespace std;
5
6 int main()
7 {
8     char input;
9
10    cout << "Enter any character: ";
11    cin.get(input);
12    cout << "The character you entered is: "
<< input << endl;
13    if (isalpha(input))
14        cout << "That's an alphabetic
character.\n";
15    if (isdigit(input))
16        cout << "That's a numeric digit.\n";
17    if (islower(input))
18        cout << "The letter you entered is
lowercase.\n";
19    if (isupper(input))
```


```
20         cout << "The letter you entered is  
uppercase.\n";  
21     if (isspace(input))  
22         cout << "That's a whitespace  
character.\n";  
23     return 0;  
24 }
```

### Program Output with Example Input Shown in Bold

```
Enter any character: A Enter  
The character you entered is: A  
That's an alphabetic character.  
The letter you entered is uppercase.
```

### Program Output with Different Example Input Shown in Bold

```
Enter any character: 7 Enter  
The character you entered is: 7  
That's a numeric digit.
```

**Program 10-2**  shows a more practical application of the character-testing functions. It tests a seven-character customer number to determine whether it is in the proper format.

## Program 10-2

```
1 // This program tests a customer number to
determine whether
2 // it is in the proper format.
3 #include <iostream>
4 #include <cctype>
5 using namespace std;
6
7 // Function prototype
8 bool testNum(char [], int);
9
10 int main()
11 {
12     const int SIZE = 8; // Array size
13     char customer[SIZE]; // To hold a
customer number
14
15     // Get the customer number.
16     cout << "Enter a customer number in the
form ";
17     cout << "LLLNNNN\n";
18     cout << "(LLL = letters and NNNN =
numbers): ";
19     cin.getline(customer, SIZE);
```

```

20
21     // Determine whether it is valid.
22     if (testNum(customer, SIZE))
23         cout << "That's a valid customer
number.\n";
24     else
25     {
26         cout << "That is not the proper format
of the ";
27         cout << "customer number.\nHere is an
example:\n";
28         cout << "   ABC1234\n";
29     }
30     return 0;
31 }
32
33
//*****
*****
34 // Definition of function testNum.
*
35 // This function determines whether the
custNum parameter *
36 // holds a valid customer number. The size
parameter is *
37 // the size of the custNum array.
*

```

```

38
//*****
*****
39
40 bool testNum(char custNum[], int size)
41 {
42     int count; // Loop counter
43
44     // Test the first three characters for
alphabetic letters.
45     for (count = 0; count < 3; count++)
46     {
47         if (!isalpha(custNum[count]))
48             return false;
49     }
50
51     // Test the remaining characters for
numeric digits.
52     for (count = 3; count < size - 1; count++)
53     {
54         if (!isdigit(custNum[count]))
55             return false;
56     }
57     return true;
58 }

```

**Program Output with Example Input Shown in Bold**

```
Enter a customer number in the form LLLNNNN
(LLL = letters and NNNN = numbers): RQS4567
Enter
That's a valid customer number.
```

### Program Output with Different Example Input Shown in Bold

```
Enter a customer number in the form LLLNNNN
(LLL = letters and NNNN = numbers): AX467T9
Enter
That is not the proper format of the
customer number.
Here is an example:
    ABC1234
```

In this program, the customer number is expected to consist of three alphabetic letters followed by four numeric digits. The `testNum` function accepts an array argument and tests the first three characters with the following loop in lines 45 through 49:



```
for (count = 0; count < 3; count++)  
{  
    if (!isalpha(custNum[count]))  
        return false;  
}
```

The `isalpha` function returns `true` if its argument is an alphabetic character. The `!` operator is used in the `if` statement to determine whether the tested character is NOT alphabetic. If this is so for any of the first three characters, the function `testNum` returns `false`. Likewise, the next four characters are tested to determine whether they are numeric digits with the following loop in lines 52 through 56:

```
for (count = 3; count < size - 1; count++)  
{  
    if (!isdigit(custNum[count]))  
        return false;  
}
```

The `isdigit` function returns `true` if its argument is the character representation of any of the digits 0 through 9. Once again, the `!` operator is used to determine whether the tested character is *not* a digit. If this is so for any of the last four characters, the function `testNum` returns `false`. If the customer number is in the proper

format, the function will cycle through both the loops without returning `false`. In that case, the last line in the function is the `return true` statement, which indicates the customer number is valid.

## 10.2 Character Case Conversion

### Concept:

The C++ library offers functions for converting a character to uppercase or lowercase.

The C++ library provides two functions, `toupper` and `tolower`, for converting the case of a character. The functions are described in [Table 10-2](#). (These functions are prototyped in the header file `<cctype>`, so be sure to include it.)

### Table 10-2 Case-Conversion Functions in `<cctype>`

Each of the functions in [Table 10-2](#) accepts a single character argument. If the argument is a lowercase letter, the `toupper` function returns its uppercase equivalent. For example, the following statement will display the character `A` on the screen:

```
cout << toupper('a');
```

If the argument is already an uppercase letter, `toupper` returns it unchanged. The following statement causes the character `Z` to be displayed:

```
cout << toupper('Z');
```

Any nonletter argument passed to `toupper` is returned as it is. Each of the following statements displays `toupper`'s argument without any change:

```
cout << toupper('*'); // Displays *
cout << toupper('&'); // Displays &
cout << toupper('%'); // Displays %
```


`toupper` and `tolower` don't actually cause the character argument to change; they simply return the uppercase or lowercase equivalent of the argument. For example, in the following program segment, the variable `letter` is set to the value 'A'. The `tolower` function returns the character 'a', but `letter` still contains 'A'.

```
char letter = 'A';
cout << tolower(letter) << endl;
cout << letter << endl;
```

These statements will cause the following to be displayed:

```
a
```

```
A
```

**Program 10-3**  demonstrates the `toupper` function in an input validation loop.

## Program 10-3

```
1 // This program calculates the area of a
circle. It asks the user
2 // if he or she wishes to continue. A loop
that demonstrates the
3 // toupper function repeats until the user
enters 'y', 'Y',
4 // 'n', or 'N'.
5 #include <iostream>
6 #include <cctype>
7 #include <iomanip>
8 using namespace std;
9
10 int main()
11 {
12     const double PI = 3.14159; // Constant
for pi
13     double radius;           // The
circle's radius
14     char goAgain;           // To hold Y
or N
15
16     cout << "This program calculates the area
of a circle.\n";
```

```
17     cout << fixed << setprecision(2);
18
19     do
20     {
21         // Get the radius and display the
area.
22         cout << "Enter the circle's radius: ";
23         cin >> radius;
24         cout << "The area is " << (PI * radius
* radius);
25         cout << endl;
26
27         // Does the user want to do this
again?
28         cout << "Calculate another? (Y or N)
";
29         cin >> goAgain;
30
31         // Validate the input.
32         while (toupper(goAgain) != 'Y' &&
toupper(goAgain) != 'N')
33         {
34             cout << "Please enter Y or N: ";
35             cin >> goAgain;
36         }
37
38     } while (toupper(goAgain) == 'Y');
```

```
39     return 0;
40 }
```

## Program Output with Example Input Shown in Bold

```
This program calculates the area of a
circle.
Enter the circle's radius: 10 Enter
The area is 314.16
Calculate another? (Y or N) b Enter
Please enter Y or N: y Enter
Enter the circle's radius: 1 Enter
The area is 3.14
Calculate another? (Y or N) n Enter
```

In lines 28 and 29, the user is prompted to enter either Y or N to indicate whether he or she wants to calculate another area. We don't want the program to be so picky that it accepts only uppercase Y or uppercase N. Lowercase y or lowercase n is also acceptable. The input validation loop must be written to reject anything except `'Y'`, `'y'`, `'N'`, or `'n'`. One way to do this would be to test the `goAgain` variable in four relational expressions, as shown here:



```
while (goAgain != 'Y' && goAgain != 'y' &&  
    goAgain != 'N' && goAgain != 'n')
```

Although there is nothing wrong with this code, we could use the `toupper` function to get the uppercase equivalent of `goAgain` and make only two comparisons. This is the approach taken in line 32:

```
while (toupper(goAgain) != 'Y' && toupper(goAgain) != 'N')
```

Another approach would have been to use the `tolower` function to get the lowercase equivalent of `goAgain`. Here is an example:

```
while (tolower(goAgain) != 'y' && tolower(goAgain) != 'n')
```

Either approach will yield the same results.



10.1 Write a short description of each of the following functions:

```
isalpha
isalnum
isdigit
islower
isprint
ispunct
isupper
isspace
toupper
tolower
```

10.2 Write a statement that will convert the contents of the `char` variable `big` to lowercase. The converted value should be assigned to the variable `little`.

10.3 Write an `if` statement that will display the word “digit” if the variable `ch` contains a numeric digit. Otherwise, it should display “Not a digit.”

10.4 What is the output of the following statement?

```
cout << toupper(tolower('A'));
```

10.5 Write a loop that asks the user “Do you want to repeat the program or quit? (R/Q)”. The loop should repeat until the user has entered an R or a Q (either uppercase or lowercase).

## 10.3 C-Strings

### Concept:

In C++, a C-string is a sequence of characters stored in consecutive memory locations, terminated by a null character.

*String* is a generic term that describes any consecutive sequence of characters. A word, a sentence, a person's name, and the title of a song are all strings. In the C++ language, there are two primary ways that strings are stored in memory: as `string` objects or as C-strings. You have already been introduced to the `string` class, and by now, you have written several programs that use `string` objects. In this section, we will use C-strings, which are an alternative method for storing and working with strings.

A *C-string* is a string whose characters are stored in consecutive memory locations and are followed by a null character, or null terminator. Recall from [Chapter 2](#) that a null character or null terminator is a byte holding the ASCII code 0. Strings that are stored this way are called C-strings because this is the way strings are handled in the C programming language.

In C++, all string literals are stored in memory as C-strings. Recall that a string literal (or string constant) is the literal representation of a string in a program. In C++, string literals are enclosed in double quotation marks, such as:

```
"Bailey"
```

**Figure 10-1** illustrates how the string literal `"Bailey"` is stored in memory, as a C-string.

**Figure 10-1 A C-string stored in memory**

B	a	i	l	e	y	\0
---	---	---	---	---	---	----

**Note:**

Remember that `\0` (“slash zero”) is the escape sequence representing the null terminator. It stands for the ASCII code 0.

The purpose of the null terminator is to mark the end of the C-string. Without it, there would be no way for a program to know the length of a C-string.

# More about String Literals

A string literal or string constant is enclosed in a set of double quotation marks ( " "). For example, here are five string literals:

```
"Have a nice day."  
"What is your name?"  
"John Smith"  
"Please enter your age:"  
"Part Number 45Q1789"
```

All of a program's string literals are stored in memory as C-strings, with the null terminator automatically appended. For example, look at [Program 10-4](#).

## Program 10-4

```
1 // This program contains string literals.  
2 #include <iostream>  
3 using namespace std;  
4  
5 int main()  
6 {  
7     char again;  
8  
9     do  
10    {  
11        cout << "C++ programming is great fun!" << endl;  
12        cout << "Do you want to see the message again? ";  
13        cin >> again;  
14    } while (again == 'Y' || again == 'y');  
15    return 0;  
16 }
```

This program contains two string literals:

```
"C++ programming is great fun!"  
"Do you want to see the message again? "
```

The first string occupies 30 bytes of memory (including the null terminator), and the second string occupies 39 bytes. They appear in memory in the following forms:

It's important to realize that a string literal has its own storage location, just like a variable or an array. When a string literal appears in a statement, it's actually its memory address that C++ uses. Look at the following example:

```
cout << "Do you want to see the message again? ";
```

In this statement, the memory address of the string literal "Do you want to see the message again?" is passed to the `cout` object. `cout` displays the consecutive characters found at this address. It stops displaying the characters when a null terminator is encountered.

# C-Strings Stored in Arrays

The C programming language does not provide a `string` class like that which C++ provides. In the C language, all strings are treated as C-strings. When a C programmer wants to store a string in memory, he or she has to create a `char` array that is large enough to hold the string, plus one extra element for the null character.

You might be wondering why this should matter to anyone learning C++. You need to know about C-strings for the following reasons:

- The `string` class has not always existed in the C++ language. Several years ago, C++ stored strings as C-strings. As a professional programmer, you might encounter older C++ code (known as *legacy code*) that uses C-strings.
- Some of the C++ library functions work only with C-strings.
- In the workplace, it is not unusual for C++ programmers to work with specialized libraries that are written in C. Any strings with which C libraries work will be C-strings.

As previously mentioned, if you want to store a C-string in memory, you have to define a `char` array that is large enough to hold the string, plus one extra element for the null character. Here is an example:

```
const int SIZE = 21;
char name[SIZE];
```

This code defines a `char` array that has 21 elements, so it is big enough to hold a C-string that is no more than 20 characters long.

You can initialize a `char` array with a string literal, as shown here:

```
const int SIZE = 21;
char name[SIZE] = "Jasmine";
```

After this code executes, the `name` array will be created with 21 elements. The first eight elements will be initialized with the characters `'J'`, `'a'`, `'s'`, `'m'`, `'i'`, `'n'`, `'e'`, and `'\0'`. The null character is automatically added as the last character. You can implicitly size a `char` array by initializing it with a string literal, as shown here:



```
char name[] = "Jasmine";
```

After this code executes, the `name` array will be created with eight elements, initialized with the characters `'J'`, `'a'`, `'s'`, `'m'`, `'i'`, `'n'`, `'e'`, and `'\0'`.

C-string input can be performed by the `cin` object. For example, the following code allows the user to enter a string (with no whitespace characters) into the `name` array:

```
const int SIZE = 21;
char name[SIZE];
cin >> name;
```

Recall from [Chapter 7](#) that an array name with no brackets and no subscript is converted into the beginning address of the array. In the previous statement, `name` indicates the address in memory where the string is to be stored. Of course, `cin` has no way of knowing that `name` has 21 elements. If the user enters a string of 30 characters, `cin` will write past the end of the array. This can be prevented by using `cin`'s `getline` member function. Assume the following array has been defined in a program:

```
const int SIZE = 80;
char line[SIZE];
```

The following statement uses `cin`'s `getline` member function to get a line of input (including whitespace characters) and store it in the `line` array:

```
cin.getline(line, SIZE);
```

The first argument tells `getline` where to store the string input. This statement indicates the starting address of the `line` array as the storage location for the string. The second argument indicates the maximum length of the string, including the null terminator. In this example, the `SIZE` constant is equal to 80, so `cin` will read 79 characters, or until the user presses the `Enter` key, whichever comes first. `cin` will automatically append the null terminator to the end of the string.

Once a string is stored in an array, it can be processed using standard subscript notation. For example, [Program 10-5](#) displays a string stored in an array. It uses a loop to display each character in the array until the null terminator is encountered.

## Program 10-5

```
1 // This program displays a string stored in a char array.
2 #include <iostream>
3 using namespace std;
4
5 int main()
6 {
7     const int SIZE = 80; // Array size
8     char line[SIZE]; // To hold a line of input
9     int count = 0; // Loop counter variable
10
11     // Get a line of input.
12     cout << "Enter a sentence of no more than "
13         << (SIZE - 1) << " characters:\n";
14     cin.getline(line, SIZE);
15
16     // Display the input one character at a time.
17     cout << "The sentence you entered is:\n";
18     while (line[count] != '\0')
19     {
20         cout << line[count];
21         count++;
22     }
23     return 0;
24 }
```

### Program Output with Example Input Shown in Bold

```
Enter a sentence of no more than 79 characters:
C++ is challenging but fun! Enter
The sentence you entered is:
C++ is challenging but fun!
```

## 10.4 Library Functions for Working with C-Strings

### **Concept:**

The C++ library has numerous functions for handling C-strings. These functions perform various tests and manipulations, and require the `<cstring>` header file be included.

# The `strlen` Function

Because C-strings are stored in arrays, working with them is quite different from working with `string` objects. Fortunately, the C++ library provides many functions for manipulating and testing C-strings. These functions all require the `<cstring>` header file to be included, as shown here:

```
#include <cstring>
```

For instance, the following code segment uses the `strlen` function to determine the length of the string stored in the `name` array:

```
char name[] = "Thomas Edison";  
int length;  
length = strlen(name);
```

The `strlen` function accepts a pointer to a C-string as its argument. It returns the length of the string, which is the number of characters up to, but not including, the null terminator. As a result, the variable `length` will have the number 13 stored in it. The length of a string isn't to be confused with the size of the array holding it. Remember, the only information being passed to `strlen` is the beginning address of a C-string. It doesn't know where the array ends, so it looks for the null terminator to indicate the end of the string.

When using a C-string-handling function, you must pass one or more C-strings as arguments. This means passing the address of the C-string, which may be accomplished by using any of the following as arguments:

- The name of the array holding the C-string
- A pointer variable that holds the address of the C-string
- A literal string

Anytime a literal string is used as an argument to a function, the address of the literal string is passed. Here is an example of the `strlen` function being used with such an argument:

```
length = strlen("Thomas Edison");
```

# The `strcat` Function

The `strcat` function accepts two pointers to C-strings as its arguments. The function *concatenates*, or appends one string to another. The following code shows an example of its use:


```
const int SIZE = 13;
char string1[SIZE] = "Hello ";
char string2[] = "World!";

cout << string1 << endl;
cout << string2 << endl;
strcat(string1, string2);
cout << string1 << endl;
```

These statements will cause the following output:

```
Hello
World!
Hello World!
```

The `strcat` function copies the contents of `string2` to the end of `string1`. In this example, `string1` contains the string "Hello " before the call to `strcat`. After the call, it contains the string "Hello World!".

**Figure 10-2**  shows the contents of both arrays before and after the function call.

## Figure 10-2 Using `strcat`

Before the call to `strcat (string1, string2)`:

string1

H	e	l	l	o		\0						
---	---	---	---	---	--	----	--	--	--	--	--	--

string2

W	o	r	l	d	!	\0
---	---	---	---	---	---	----

After the call to `strcat (string1, string2)`:

string1

H	e	l	l	o		W	o	r	l	d	!	\0
---	---	---	---	---	--	---	---	---	---	---	---	----

string2

W	o	r	l	d	!	\0
---	---	---	---	---	---	----

Notice the last character in `string1` (before the null terminator) is a space. The `strcat` function doesn't insert a space, so it's the programmer's responsibility to make sure one is already there, if needed. It's also the programmer's responsibility to make sure the array holding `string1` is large enough to hold `string1` plus `string2` plus a null terminator.

Here is a program segment that uses the `sizeof` operator to test an array's size before `strcat` is called:

```
if (sizeof(string1) >= (strlen(string1) + strlen(string2) + 1))
    strcat(string1, string2);
else
    cout << "String1 is not large enough for both strings.\n";
```



### **Warning!**

If the array holding the first string isn't large enough to hold both strings, `strcat` will overflow the boundaries of the array.

# The `strcpy` Function

Recall from [Chapter 7](#) that one array cannot be assigned to another with the `=` operator. Each individual element must be assigned, usually inside a loop. The `strcpy` function can be used to copy one string to another. Here is an example of its use:

```
const int SIZE = 13;
char name[SIZE];
strcpy(name, "Albert Einstein");
```

The `strcpy` function's two arguments are C-string addresses. The contents of the second argument are copied to the memory location specified by the first argument, including the null terminator. (The first argument usually references an array.) In this example, the `strcpy` function will copy the string "Albert Einstein" to the `name` array.

If anything is already stored in the location referenced by the first argument, it is overwritten, as shown in the following program segment:

```
const int SIZE = 10;
char string1[SIZE] = "Hello", string2[SIZE] = "World!";
cout << string1 << endl;
cout << string2 << endl;
strcpy(string1, string2);
cout << string1 << endl;
cout << string2 << endl;
```

Here is the output:

```
Hello
World!
World!
World!
```



### ***Warning!***

Being true to C++'s nature, `strcpy` performs no bounds checking. The array specified by the first argument will be overflowed if it isn't large enough to hold the string specified by the second argument.



# The `strncat` and `strncpy` Functions

Because the `strcat` and `strcpy` functions can potentially overwrite the bounds of an array, they make it possible to write unsafe code. As an alternative, you should use `strncat` and `strncpy` whenever possible.

The `strncat` function works like `strcat`, except it takes a third argument specifying the maximum number of characters from the second string to append to the first. Here is an example call to `strncat`:

```
strncat(string1, string2, 10);
```

When this statement executes, `strncat` will append no more than 10 characters from `string2` to `string1`. The following code shows an example of calculating the maximum number of characters that can be appended to an array:

```
1 int maxChars;
2 const int SIZE_1 = 17;
3 const int SIZE_2 = 18;
4
5 char string1[SIZE_1] = "Welcome ";
6 char string2[SIZE_2] = "to North Carolina";
7
8 cout << string1 << endl;
9 cout << string2 << endl;
10 maxChars = sizeof(string1) - (strlen(string1) + 1);
11 strncat(string1, string2, maxChars);
12 cout << string1 << endl;
```

The statement in line 10 calculates the number of empty elements in `string1`. It does this by subtracting the length of the string stored in the array plus 1 for the null terminator. This code will cause the following output:

```
Welcome
to North Carolina
Welcome to North
```

The `strncpy` function allows you to copy a specified number of characters from a string to a destination. Calling `strncpy` is similar to calling `strcpy`, except you pass a third argument specifying the maximum number of characters from the second string to copy to the first. Here is an example call to `strncpy`:

```
strncpy(string1, string2, 5);
```

When this statement executes, `strncpy` will copy no more than five characters from `string2` to `string1`. However, if the specified number of characters is less than or equal to the length of `string2`, a null terminator is not appended to `string1`. If the specified number of characters is greater than the length of `string2`, then `string1` is padded with null terminators, up to the specified number of characters. The following code shows an example using the `strncpy` function:

```
1 int maxChars;
2 const int SIZE = 11;
3
4 char string1[SIZE];
5 char string2[] = "I love C++ programming!";
6
7 maxChars = sizeof(string1) - 1;
8 strncpy(string1, string2, maxChars);
9 // Put the null terminator at the end.
10 string1[maxChars] = '\0';
11 cout << string1 << endl;
```

Notice a statement was written in line 10 to put the null terminator at the end of `string1`. This is because `maxChars` was less than the length of `string2`, and `strncpy` did not automatically place a null terminator there.

# The `strstr` Function

The `strstr` function searches for a string inside of a string. For instance, it could be used to search for the string “seven” inside the larger string “Four score and seven years ago.” The function’s first argument is the string to be searched, and the second argument is the string for which to look. If the function finds the second string inside the first, it returns the address of the occurrence of the second string within the first string. Otherwise, it returns `nullptr` (the address 0). Here is an example:

```
char arr[] = "Four score and seven years ago";
char *strPtr = nullptr;
cout << arr << endl;
strPtr = strstr(arr, "seven"); // search for "seven"
cout << strPtr << endl;
```

In this code, `strstr` will locate the string “seven” inside the string “Four score and seven years ago.” It will return the address of the first character in “seven” which will be stored in the pointer variable `strPtr`. If run as part of a complete program, this segment will display the following:

```
Four score and seven years ago
seven years ago
```



## **Note:**

The `nullptr` key word was introduced in C++ 11. If you are using a previous version of the C++ language, use the constant `NULL` instead.

The `strstr` function can be useful in any program that must locate data inside one or more strings.

**Program 10-6** [□](#), for example, stores a list of product numbers and descriptions in an array of C-strings. It allows the user to look up a product description by entering all or part of its product number.

## Program 10-6

```
1 // This program uses the strstr function to search an array.
2 #include <iostream>
3 #include <cstring> // For strstr
4 using namespace std;
5
6 int main()
7 {
8     // Constants for array lengths
9     const int NUM_PRODS = 5; // Number of products
10    const int LENGTH = 27; // String length
11
12    // Array of products
13    char products[NUM_PRODS][LENGTH] =
14        { "TV327 31-inch Television",
15          "CD257 CD Player",
16          "TA677 Answering Machine",
17          "CS109 Car Stereo",
18          "PC955 Personal Computer" };
19
20    char lookUp[LENGTH]; // To hold user's input
21    char *strPtr = nullptr; // To point to the found product
22    int index; // Loop counter
23
24    // Prompt the user for a product number.
25    cout << "\tProduct Database\n\n";
26    cout << "Enter a product number to search for: ";
27    cin.getline(lookUp, LENGTH);
28
29    // Search the array for a matching substring
30    for (index = 0; index < NUM_PRODS; index++)
31    {
32        strPtr = strstr(products[index], lookUp);
33        if (strPtr != nullptr)
34            break;
35    }
36
37    // If a matching substring was found, display the product info.
```

```

38     if (strPtr != nullptr)
39         cout << products[index] << endl;
40     else
41         cout << "No matching product was found.\n";
42
43     return 0;
44 }

```

### Program Output with Example Input Shown in Bold

```

Product Database
Enter a product to search for: CS Enter
CS109 Car Stereo

```

### Program Output with Different Example Input Shown in Bold

```

Product Database
Enter a product to search for: AB Enter
No matching product was found.

```

**Table 10-3** summarizes the string-handling functions discussed here, as well as the `strcmp` function that was discussed in **Chapter 4**. (All the functions listed require the `<cstring>` header file.)

#### Table 10-3 Some of the C-String Functions in `<cstring>`

In **Program 10-6**, the `for` loop in lines 30 through 35 steps through each C-string in the array calling the following statement:

```
strPtr = strstr(prods[index], lookUp);
```

The `strstr` function searches the string referenced by `prods[index]` for the name entered by the user, which is stored in `lookUp`. If `lookUp` is found inside `prods[index]`, the function returns its address. In that case, the following `if` statement causes the `for` loop to terminate:

```
if (strPtr != nullptr)
    break;
```

Outside the loop, the following `if else` statement in lines 38 through 41 determines whether the string entered by the user was found in the array. If not, it informs the user that no matching product was found. Otherwise, the product number and description are displayed.

```
if (strPtr == nullptr)
    cout << "No matching product was found.\n";
else
    cout << prods[index] << endl;
```

# The `strcmp` Function

Because C-strings are stored in `char` arrays, you cannot use the relational operators to compare two C-strings. To compare C-strings, you should use the library function `strcmp`. This function takes two C-strings as arguments and returns an integer that indicates how the two strings compare to each other. Here is the function's prototype:

```
int strcmp(char *string1, char *string2);
```

The function takes two C-strings as parameters (actually, pointers to C-strings) and returns an integer result. The value of the result is set accordingly:

- The result is *zero* if the two strings are *equal* on a character-by-character basis.
- The result is *negative* if `string1` comes *before* `string2` in alphabetical order.
- The result is *positive* if `string1` comes *after* `string2` in alphabetical order.

Here is an example of the use of `strcmp` to determine if two strings are equal:

```
if (strcmp(string1, string2) == 0)
    cout << "The strings are equal.\n";
else
    cout << "The strings are not equal.\n";
```

**Program 10-7**  shows a complete example.


## Program 10-7


```
1 // This program tests two C-strings for equality
2 // using the strcmp function.
3 #include <iostream>
4 #include <string>
5 using namespace std;
6
7 int main()
8 {
9     // Two arrays for two strings.
10    const int LENGTH = 40;
11    char firstString[LENGTH], secondString[LENGTH];
12
13    // Read two strings.
14    cout << "Enter a string: ";
15    cin.getline(firstString, LENGTH);
16    cout << "Enter another string: ";
17    cin.getline(secondString, LENGTH);
18
19    // Compare the strings for equality with strcmp.
20    if (strcmp(firstString, secondString) == 0)
21        cout << "You entered the same string twice.\n";
22    else
23        cout << "The strings are not the same.\n";
24
25    return 0;
26 }
```

### Program Output with Example Input Shown in Bold

```
Enter a string: Alfonso Enter
Enter another string: Alfonso Enter
You entered the same string twice.
```



The `strcmp` function is case sensitive when it compares strings. If the user enters “Dog” and “dog” in **Program 10-7** , it will report they are not the same. Most compilers provide nonstandard versions of `strcmp` that perform case-insensitive comparisons. For instance, some compilers provide a function named `stricmp` that works identically to `strcmp`, except the case of the characters is ignored.

**Program 10-8**  is a more practical example of how `strcmp` can be used. It asks the user to enter the part number of the MP3 player they wish to purchase. The part number contains digits, letters, and a hyphen, so it must be stored as a string. Once the user enters the part number, the program displays the price of the stereo.

## Program 10-8

```
1 // This program uses strcmp to compare the string entered
2 // by the user with the valid MP3 player part numbers.
3 #include <iostream>
4 #include <cstring>
5 #include <iomanip>
6 using namespace std;
7
8 int main()
9 {
10     // Price of parts.
11     const double A_PRICE = 99.0,
12                B_PRICE = 199.0;
13
14     // Character array for part number.
15     const int PART_LENGTH = 9;
16     char partNum[PART_LENGTH];
17
18     // Instruct the user to enter a part number.
19     cout << "The MP3 player part numbers are:\n"
20          << "\t16 Gigabyte, part number S147-29A\n"
21          << "\t32 Gigabyte, part number S147-29B\n"
22          << "Enter the part number of the MP3 player you\n"
23          << "wish to purchase: ";
24
25     // Read a part number of at most 8 characters.
26     cin >> partNum;
27
28     // Determine what user entered using strcmp
29     // and print its price.
30     cout << showpoint << fixed << setprecision(2);
31     if (strcmp(partNum, "S147-29A") == 0)
32         cout << "The price is $" << A_PRICE << endl;
33     else if (strcmp(partNum, "S147-29B") == 0)
34         cout << "The price is $" << B_PRICE << endl;
35     else
36         cout << partNum << " is not a valid part number.\n";
```

```
37     return 0;
38 }
```

### Program Output with Example Input Shown in Bold

```
The MP3 player part numbers are:
    16 Gigabyte, part number S147-29A
    32 Gigabyte, part number S147-29B
Enter the part number of the stereo you
wish to purchase: S147-29B Enter
The price is $199.00
```

## Using `!` with `strcmp`

Some programmers prefer to use the logical NOT operator with `strcmp` when testing strings for equality. Because 0 is considered logically false, the `!` operator converts that value to true. The expression `!strcmp(string1, string2)` returns `true` when both strings are the same, and false when they are different. The two following statements perform the same operation:

```
if (strcmp(firstString, secondString) == 0)
if (!strcmp(firstString, secondString))
```

# Sorting Strings

Programs are frequently written to print alphabetically sorted lists of items. For example, consider a department store computer system that keeps customers' names and addresses in a file. The names do not appear in the file alphabetically, but in the order the operator entered them. If a list were to be printed in this order, it would be very difficult to locate any specific name. The list would have to be sorted before it was printed.

Because the value returned by `strcmp` is based on the relative alphabetic order of the two strings being compared, it can be used in programs that sort strings. [Program 10-9](#) asks the user to enter two names, which are then printed in alphabetic order.

## Program 10-9

```
1 // This program uses the return value of strcmp to
2 // alphabetically sort two strings entered by the user.
3 #include <iostream>
4 #include <string>
5 using namespace std;
6
7 int main()
8 {
9     // Two arrays to hold two strings.
10    const int NAME_LENGTH = 30;
11    char name1[NAME_LENGTH], name2[NAME_LENGTH];
12
13    // Read two strings.
14    cout << "Enter a name (last name first): ";
15    cin.getline(name1, NAME_LENGTH);
16    cout << "Enter another name: ";
17    cin.getline(name2, NAME_LENGTH);
18
19    // Print the two strings in alphabetical order.
20    cout << "Here are the names sorted alphabetically:\n";
21    if (strcmp(name1, name2) < 0)
22        cout << name1 << endl << name2 << endl;
23    else if (strcmp(name1, name2) > 0)
24        cout << name2 << endl << name1 << endl;
25    else
26        cout << "You entered the same name twice!\n";
27
28    return 0;
29 }
```

**Program Output with Example Input Shown in Bold**


```
Enter a name (last name first): Smith, Richard Enter
```

```
Enter another name: Jones, John Enter
```

```
Here are the names sorted alphabetically:
```

```
Jones, John
```

```
Smith, Richard
```

**Table 10-3**  provides a summary of the C-string-handling functions we have discussed. All of the functions listed require the `<cstring>` header file.



10.6 Write a short description of each of the following functions:

```
strlen  
strcat  
strcpy  
strncat  
strncpy  
strcmp  
strstr
```

10.7 What will the following program segment display?

```
char dog[] = "Fido";  
cout << strlen(dog) << endl;
```

10.8 What will the following program segment display?

```
char string1[16] = "Have a ";  
char string2[9] = "nice day";  
strcat(string1, string2);  
cout << string1 << endl;  
cout << string2 << endl;
```

10.9 Write a statement that will copy the string "Beethoven" to the array `composer`.

10.10 When complete, the following program skeleton will search for the string "Windy" in the array `place`. If `place` contains "Windy" the program will display the message "Windy found." Otherwise, it will display "Windy not found."

```
#include <iostream>
// include any other necessary header files
using namespace std;
int main()
{
    char place[] = "The Windy City";
    // Complete the program. It should search the array place
    // for the string "Windy" and display the message "Windy
    // found" if it finds the string. Otherwise, it should
    // display the message "Windy not found."
    return 0;
}
```



# 10.5 String/Numeric Conversion Functions

## Concept:

The C++ library provides functions for converting C-strings and `string` objects to numeric data types and vice versa.

There is a great difference between a number that is stored as a string, and one stored as a numeric value. The string “`26792`” isn’t actually a number, but a series of ASCII codes representing the individual digits of the number. It uses 6 bytes of memory (including the null terminator). Because it isn’t an actual number, it’s not possible to perform mathematical operations with it, unless it is first converted to a numeric value.

Several functions exist in the C++ library for converting C-string representations of numbers into numeric values. [Table 10-4](#) shows some of these. Note all of these functions require the `<cstdlib>` header file.

**Table 10-4 C-String/Numeric Conversion Functions in `<cstdlib>`**



## Note:

If a C-string that cannot be converted to a numeric value is passed to any of the functions in [Table 10-4](#), the function's behavior is undefined by C++. Many compilers, however, will perform the conversion process until an invalid character is encountered. For example, `atoi("123x5")` might return the integer 123. It is possible that these functions will return 0 if they cannot successfully convert their argument.

# The `string` to Number Functions

**11** C++ 11 introduced several new functions that convert `string` objects to numeric values. [Table 10-5](#) lists the functions. To use any of the functions in [Table 10-5](#), you must `#include` the `<string>` header file.

**Table 10-5** `string` to Number Functions



## **Note:**

If a `string` that cannot be converted to a numeric value is passed to any of the functions in [Table 10-5](#), the function will throw an `invalid_argument` exception. If the `string` argument converts to a value that is out of range for the target data type, the function will throw an `out_of_range` exception.

The functions shown in [Table 10-5](#) can accept either a `string` object or a C-string as an argument. For example, each of the following code snippets use the `stoi` function to convert the string “99” to an `int`:

```
// Convert a string object to an int.
```

```
string str = "99";
```

```
int i = stoi(str);
```

```
// Convert a string literal to an int.
```

```
int i = stoi("99");
```

```
// Convert a C-String in a char array to an int.
```

```
char cstr[] = "99";
```

```
int i = stoi(cstr);
```

# The `to_string` Function

**11** C++ 11 introduces a function named `to_string` that converts a numeric value to a `string` object. There are nine overloaded versions of the `to_string` function listed in [Table 10-6](#). Note the `to_string` function requires the `<string>` header file to be included.

## Table 10-6 Overloaded Versions of the `to_string` Function

Each version of the function accepts an argument of a numeric data type and returns the value of that argument converted to a `string` object. Here is an example:


```
int number = 99;  
string output = to_string(number);
```

The first statement initializes the `number` variable (an `int`) to the value 99. In the second statement, the `number` variable is passed as an argument to the `to_string` function. The `to_string` function returns the value “99”, which is assigned to the `output` variable.

Here is another example:

```
double number = 3.14159;  
cout << to_string(number) << endl;
```

The first statement initializes the `number` variable (a `double`) to the value 3.14159. In the second statement, the `number` variable is passed as an argument to the `to_string` function, and the value “3.14159” is returned from the function and displayed on the screen.

Now let’s look at **Program 10-10** , which uses one of the C++ 11 `string`-to-number conversion functions, `stoi`. It allows the user to enter a series of values, or the letter `Q` or `q` to quit. The average of the numbers is then calculated and displayed.

## Program 10-10

```
1 // This program demonstrates the tolower and
stoi functions.
2 #include <iostream>
3 #include <cctype> // For tolower
4 #include <string>
5 using namespace std;
6
7 int main()
8 {
9     string input; // To hold user input
10    int total = 0; // Accumulator
11    int count = 0; // Loop counter
12    double average; // To hold the
average of numbers
13
14    // Get the first number.
15    cout << "This program will average a series
of numbers.\n";
16    cout << "Enter the first number or Q to
quit: ";
17    getline(cin, input);
18
19    // Process the number and subsequent
```

```

numbers.
20     while (tolower(input[0]) != 'q')
21     {
22         total += stoi(input);    // Keep a
running total
23         count++;                // Count the
numbers entered
24         // Get the next number.
25         cout << "Enter the next number or Q to
quit: ";
26         getline(cin, input);
27     }
28
29     // If any numbers were entered, display
their average.
30     if (count != 0)
31     {
32         average = static_cast<double>(total) /
count;
33         cout << "Average: " << average << endl;
34     }
35     return 0;
36     }

```

**Program Output with Example Input Shown in Bold**



```
This program will average a series of
numbers.
Enter the first number or Q to quit: 1
Enter
Enter the next number or Q to quit: 2 Enter
Enter the next number or Q to quit: 3 Enter
Enter the next number or Q to quit: 4 Enter
Enter the next number or Q to quit: 5 Enter
Enter the next number or Q to quit: q Enter
Average: 3
```

In line 20, the following `while` statement uses the `tolower` function to determine whether the first character entered by the user is “`q`” or “`Q`”.

```
while (tolower(input[0]) != 'q')
```

If the user hasn't entered 'Q' or 'q', the loop performs an iteration. The following statement, in line 22, uses `stoi` to convert `input` to an integer, and adds its value to `total`:

```
total += stoi(input); // Keep a running total
```


The counter is updated in line 23, then the user is asked for the next number. When all the numbers are entered, the user terminates the loop by entering 'Q' or 'q'. If one or more numbers are entered, their average is displayed.

The string-to-numeric conversion functions can also help with a common input problem. Recall from [Chapter 3](#) that using `cin >>` then calling `cin.get` causes problems because the `>>` operator leaves the newline character in the keyboard buffer. When the `cin.get` function executes, the first character it sees in the keyboard buffer is the newline character, so it reads no further.

The same problem exists when a program uses `cin >>` then calls `getline` to read a line of input. For example, look at the following code. (Assume `idNumber` is an `int` and `name` is a `string` object.)

```
1 // Get the user's ID number.
2 cout << "What is your ID number? ";
3 cin >> idNumber;
4
5 // Get the user's name.
6 cout << "What is your name? ";
7 getline(cin, name);
```

Let's say the user enters 25 and presses `Enter` when the `cin >>` statement in line 3 executes. The value 25 will be stored in `idNumber`, and the newline character will be left in the keyboard buffer. When the `getline` function is called in line 7, the first character it sees in the keyboard buffer is the newline character, so it reads no further. It will appear that the statement in line 7 was skipped.

One work-around that we have used in this book is to call `cin.ignore` to skip over the newline character just before calling `getline`. Another approach is to use `getline` to read *all* of a program's input, including numbers. When numeric input is needed, it is read into a `string` object as a string then converted to the appropriate numeric data type. Because you aren't mixing `cin >>` with `getline`, the problem of the remaining newline character doesn't exist. [Program 10-11](#)  shows an example.

## Program 10-11

```
1 // This program demonstrates how the getline
function can
2 // be used for all of a program's input.
3 #include <iostream>
4 #include <string>
5 #include <iomanip>
6 using namespace std;
7
8 int main()
9 {
10     string input;        // To hold a line of
input
11     string name;        // To hold a name
12     int idNumber;       // To hold an ID
number.
13     int age;            // To hold an age
14     double income;      // To hold income
15
16     // Get the user's ID number.
17     cout << "What is your ID number? ";
18     getline(cin, input);        // Read as
a string
19     idNumber = stoi(input);      // Convert
```

```
to int
20
21 // Get the user's name. No conversion
necessary.
22 cout << "What is your name? ";
23 getline(cin, name);
24
25 // Get the user's age.
26 cout << "How old are you? ";
27 getline(cin, input); // Read as
a string
28 age = stoi(input); // Convert
to int
29
30 // Get the user's income.
31 cout << "What is your annual income? ";
32 getline(cin, input); // Read as
a string
33 income = stod(input); // Convert
to double
34
35 // Show the resulting data.
36 cout << setprecision(2) << fixed <<
showpoint;
37 cout << "Your name is " << name
38 << ", you are " << age
39 << " years old, \nand you make $"
```

```
40         << income << " per year.\n";  
41  
42     return 0;  
43 }
```

## Program Output with Example Input Shown in Bold

```
What is your ID number? 1234 Enter  
What is your name? Janice Smith Enter  
How old are you? 25 Enter  
What is your annual income? 60000 Enter  
Your name is Janice Smith, you are 25 years  
old,  
and you make $60000.00 per year.
```



## Checkpoint

10.11 Write a short description of each of the following functions:

10.12 Write a statement that will convert the string “10” to an integer and store the result in the variable `num`.

10.13 Write a statement that will convert the string “100000” to a `long` and store the result in the variable `num`.

10.14 Write a statement that will convert the string “7.2389” to a `double` and store the result in the variable `num`.

10.15 Write a statement that will convert the integer 127 to a string, and assign the result to a `string` object named `str`.

## 10.6 Focus on Software Engineering: Writing Your Own C-String-Handling Functions

### Concept:

You can design your own specialized functions for manipulating strings.



### Writing a C-String-Handling Function

By being able to pass arrays as arguments, you can write your own functions for processing C-strings. For example, [Program 10-12](#) uses a function to copy a C-string from one array to another.



## Program 10-12

```
1 // This program uses a function to copy a C-string into an array.
2 #include <iostream>
3 using namespace std;
4
5 void stringCopy(char [], char []); // Function prototype
6
7 int main()
8 {
9     const int LENGTH = 30; // Size of the arrays
10    char first[LENGTH]; // To hold the user's input
11    char second[LENGTH]; // To hold the copy
12
13    // Get a string from the user and store in first.
14    cout << "Enter a string with no more than "
15    << (LENGTH - 1) << " characters:\n";
16    cin.getline(first, LENGTH);
17
18    // Copy the contents of first to second.
19    stringCopy(first, second);
20
21    // Display the copy.
22    cout << "The string you entered is:\n" << second << endl;
23    return 0;
24 }
25
26 //*****
27 // Definition of the stringCopy function. *
28 // This function copies the C-string in string1 to string2. *
29 //*****
30
31 void stringCopy(char string1[], char string2[])
32 {
33     int index = 0; // Loop counter
34
35     // Step through string1, copying each element to
36     // string2. Stop when the null character is encountered.
37     while (string1[index] != '\0')
```

```
38 {
39     string2[index] = string1[index];
40     index++;
41 }
42
43 // Place a null character in string2.
44 string2[index] = '\0';
45 }
```


### Program Output with Example Input Shown in Bold

```
Enter a string with no more than 29 characters:
Thank goodness it's Friday! Enter
The string you entered is:
Thank goodness it's Friday!
```

Notice the function `stringCopy` does not accept an argument indicating the size of the arrays. It simply copies the characters from `string1` into `string2` until it encounters a null terminator in `string1`. When the null terminator is found, the loop has reached the end of the C-string. The last statement in the function assigns a null terminator (the `'\0'` character) to the end of `string2`, so it is properly terminated.

### Warning!

Because the `stringCopy` function doesn't know the size of the second array, it's the programmer's responsibility to make sure the second array is large enough to hold the string in the first array.

**Program 10-13**  uses another C-string-handling function: `nameSlice`. The program asks the user to enter his or her first and last names, separated by a space. The function searches the string for the space and replaces it with a null terminator. In effect, this “cuts” the last name off of the string.

## Program 10-13

```
1 // This program uses the function nameSlice to cut the last
2 // name off of a string that contains the user's first and
3 // last names.
4 #include <iostream>
5 using namespace std;
6
7 void nameSlice(char []); // Function prototype
8
9 int main()
10 {
11     const int SIZE = 41; // Array size
12     char name[SIZE];     // To hold the user's name
13
14     cout << "Enter your first and last names, separated ";
15     cout << "by a space:\n";
16     cin.getline(name, SIZE);
17     nameSlice(name);
18     cout << "Your first name is: " << name << endl;
19     return 0;
20 }
21
22 //*****
23 // Definition of function nameSlice. This function accepts a *
24 // character array as its argument. It scans the array looking *
25 // for a space. When it finds one, it replaces it with a null *
26 // terminator. *
27 //*****
28
29 void nameSlice(char userName[])
30 {
31     int count = 0; // Loop counter
32
33     // Locate the first space, or the null terminator if there
34     // are no spaces.
35     while (userName[count] != ' ' && userName[count] != '\0')
36         count++;
37
```

```

38     // If a space was found, replace it with a null terminator.
39     if (userName[count] == ' ')
40         userName[count] = '\0';
41 }

```

### Program Output with Example Input Shown in Bold

```

Enter your first and last names, separated by a space:
Jimmy Jones Enter
Your first name is: Jimmy

```

The following loop in lines 35 and 36 starts at the first character in the array and scans the string searching for either a space or a null terminator:

```

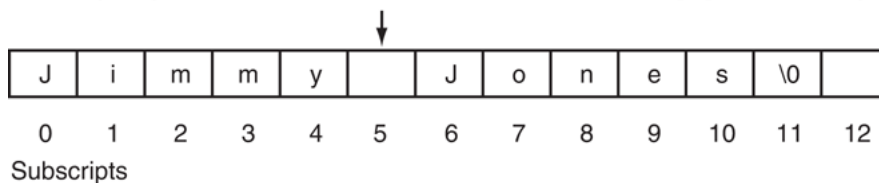
while (userName[count] != ' ' && userName[count] != '\0')
    count++;

```

If the character in `userName[count]` isn't a space or the null terminator, `count` is incremented, and the next character is examined. With the example input "`Jimmy Jones`," the loop finds the space separating "`Jimmy`" and "`Jones`" at `userName[5]`. When the loop stops, `count` is set to 5. This is illustrated in [Figure 10-3](#).

#### Figure 10-3 Scanning for a space in a string

The loop stops when `count` reaches 5 because `userName[5]` contains a space.





## Note:

The loop will also stop if it encounters a null terminator. This is so it will not go beyond the boundary of the array if the user didn't enter a space.

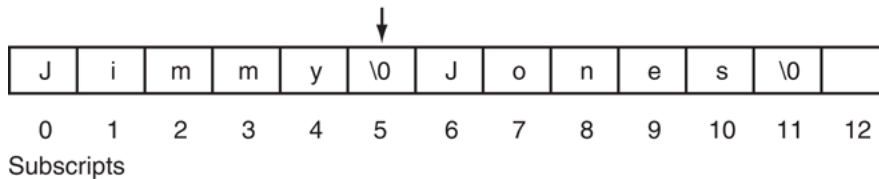
Once the loop has finished, `userName[count]` will either contain a space or a null terminator. If it contains a space, the following `if` statement (in lines 39 and 40) replaces it with a null terminator:

```
if (userName[count] == ' ')
    userName[count] = '\\0';
```

This is illustrated in [Figure 10-4](#).

### Figure 10-4 Replacing a space with a null terminator

The space is replaced with a null terminator. This now becomes the end of the string.



The new null terminator now becomes the end of the string.

# Using Pointers to Pass C-String Arguments

Pointers are extremely useful for writing functions that process C-strings. If the starting address of a string is passed into a pointer parameter variable, it can be assumed that all the characters, from that address up to the byte that holds the null terminator, are part of the string. (It isn't necessary to know the length of the array that holds the string.)

**Program 10-14**  demonstrates a function, `countChars`, that uses a pointer to count the number of times a specific character appears in a C-string.

## Program 10-14

```
1 // This program demonstrates a function, countChars, that counts
2 // the number of times a specific character appears in a string.
3 #include <iostream>
4 using namespace std;
5
6 int countChars(char *, char); // Function prototype
7
8 int main()
9 {
10     const int SIZE = 51; // Array size
11     char userString[SIZE]; // To hold a string
12     char letter; // The character to count
13
14     // Get a string from the user.
15     cout << "Enter a string (up to 50 characters): ";
16     cin.getline(userString, SIZE);
17
18     // Choose a character whose occurrences within the string will be counted.
19     cout << "Enter a character and I will tell you how many\n";
20     cout << "times it appears in the string: ";
21     cin >> letter;
22
23     // Display the number of times the character appears.
24     cout << letter << " appears ";
25     cout << countChars(userString, letter) << " times.\n";
26     return 0;
27 }
28
29 /*******
30 // Definition of countChars. The parameter strPtr is a pointer *
31 // that points to a string. The parameter Ch is a character that *
32 // the function searches for in the string. The function returns *
33 // the number of times the character appears in the string. *
34 /*******
35
36 int countChars(char *strPtr, char ch)
37 {
```

```

38     int times = 0; // Number of times ch appears in the string
39
40     // Step through the string counting occurrences of ch.
41     while (*strPtr != '\0')
42     {
43         if (*strPtr == ch) // If the current character equals ch...
44             times++;      // ... increment the counter
45         strPtr++;        // Go to the next char in the string.
46     }
47
48     return times;
49 }

```

### Program Output with Example Input Shown in Bold

```

Enter a string (up to 50 characters): Starting Out with C++ Enter
Enter a character and I will tell you how many
times it appears in the string: t Enter
t appears 4 times.

```

In the function `countChars`, `strPtr` points to the C-string that is to be searched, and `ch` contains the character for which to look. The `while` loop in lines 41 through 46 repeats as long as the character that `strPtr` points to is not the null terminator:

```
while (*strPtr != '\0')
```

Inside the loop, the `if` statement in line 43 compares the character that `strPtr` points to with the character in `ch`:

```
if (*strPtr == ch)
```

If the two are equal, the variable `times` is incremented in line 44. (`times` keeps a running total of the number of times the character appears.) The last statement in the loop is



```
strPtr++;
```

This statement increments the address in `strPtr`. This causes `strPtr` to point to the next character in the string. Then, the loop starts over. When `strPtr` finally reaches the null terminator, the loop terminates, and the function returns the value in `times`.

For another example, see the String Manipulation Case Study, available for download from the Computer Science Portal at [www.pearsonhighered.com/gaddis](http://www.pearsonhighered.com/gaddis).

## Checkpoint

10.16 What is the output of the following program?

```
#include <iostream>
using namespace std;
// Function Prototype
void mess(char []);
int main()
{
    char stuff[] = "Tom Talbert Tried Trains";
    cout << stuff << endl;
    mess(stuff);
    cout << stuff << endl;
    return 0;
}
// Definition of function mess
void mess(char str[])
{
    int step = 0;
    while (str[step] != '\0')
    {
        if (str[step] == 'T')
            str[step] = 'D';
        step++;
    }
}
```

## 10.7 More about the C++

# `string` Class

### Concept:

Standard C++ provides a special data type for storing and working with strings.

The `string` class is an abstract data type. This means it is not a built-in, primitive data type like `int` or `char`. Instead, it is a programmer-defined data type that accompanies the C++ language. It provides many capabilities that make storing and working with strings easy and intuitive.



More about the `string` Class

# Using the `string` Class

The first step in using the `string` class is to `#include` the `<string>` header file. This is accomplished with the following preprocessor directive:

```
#include <string>
```

Now you are ready to define a `string` object. Defining a `string` object is similar to defining a variable of a primitive type. For example, the following statement defines a `string` object named `movieTitle`:


```
string movieTitle;
```

You assign a string value to the `movieTitle` object with the assignment operator, as shown in the following statement:

```
movieTitle = "Wheels of Fury";
```

The contents of `movieTitle` are displayed on the screen with the `cout` object, as shown in the next statement:

```
cout << "My favorite movie is " << movieTitle << endl;
```

**Program 10-15**  is a complete program that demonstrates the statements shown above.

## Program 10-15

```
1 // This program demonstrates the string class.
2 #include <iostream>
3 #include <string> // Required for the
string class.
4 using namespace std;
5
6 int main()
7 {
8     string movieTitle;
9
10    movieTitle = "Wheels of Fury";
11    cout << "My favorite movie is " <<
movieTitle << endl;
12    return 0;
13 }
```

## Program Output

```
My favorite movie is Wheels of Fury
```

As you can see, working with `string` objects is similar to working with variables of other types. For example, **Program 10-16** [📄](#) demonstrates how you can use `cin` to read a value from the keyboard into a `string` object.

## Program 10-16

```
1 // This program demonstrates how cin can read
a string into
2 // a string class object.
3 #include <iostream>
4 #include <string>
5 using namespace std;
6
7 int main()
8 {
9     string name;
10
11     cout << "What is your name? ";
12     cin >> name;
13     cout << "Good morning " << name << endl;
14     return 0;
15 }
```

**Program Output with Example Input Shown in Bold**

```
What is your name? Peggy Enter  
Good morning Peggy
```

## Reading a Line of Input into a `string` Object

If you want to read a line of input (with spaces) into a `string` object, use the `getline()` function. Here is an example:

```
string name;  
cout << "What is your name? ";  
getline(cin, name);
```

The `getline()` function's first argument is the name of a stream object from which you wish to read the input. The function call above passes the `cin` object to `getline()`, so the function reads a line of input from the keyboard. The second argument is the name of a `string` object. This is where `getline()` stores the input that it reads.



# Comparing and Sorting `string` Objects

There is no need to use a function such as `strcmp` to compare `string` objects. You may use the `<`, `>`, `<=`, `>=`, `==`, and `!=` relational operators. For example, assume the following definitions exist in a program:

```
string set1 = "ABC";  
string set2 = "XYZ";
```

The object `set1` is considered less than the object `set2` because the characters “ABC” alphabetically precede the characters “XYZ.” So, the following `if` statement will cause the message “set1 is less than set2” to be displayed on the screen:

```
if (set1 < set2)  
    cout << "set1 is less than set2.\n";
```

Relational operators perform comparisons on `string` objects in a fashion similar to the way the `strcmp` function compares C-strings. One by one, each character in the first operand is compared with the

character in the corresponding position in the second operand. If all the characters in both strings match, the two strings are equal. Other relationships can be determined if two characters in corresponding positions do not match. The first operand is less than the second operand if the mismatched character in the first operand is less than its counterpart in the second operand. Likewise, the first operand is greater than the second operand if the mismatched character in the first operand is greater than its counterpart in the second operand.


For example, assume a program has the following definitions:

```
string name1 = "Mary";  
string name2 = "Mark";
```

The value in `name1`, "Mary," is greater than the value in `name2`, "Mark." This is because the "y" in "Mary" has a greater ASCII value than the "k" in "Mark."

`string` objects can also be compared to C-strings with relational operators. Assuming `str` is a `string` object, all of the following are valid relational expressions:

```
str > "Joseph"  
"Kimberly" < str  
str == "William"
```

**Program 10-17**  demonstrates `string` objects and relational operators.

## Program 10-17

```
1 // This program uses the == operator to
compare a string entered
2 // by the user with the valid part numbers.
3 #include <iostream>
4 #include <iomanip>
5 #include <string>
6 using namespace std;
7
8 int main()
9 {
10     const double APRICE = 249.0; // Price for
part A
11     const double BPRICE = 199.0; // Price for
part B
12     string partNum; // Part
number
13
14     cout << "The headphone part numbers are:\n";
15     cout << "\tNoise canceling, part number
S147-29A\n";
16     cout << "\tWireless, part number S147-
29B\n";
17     cout << "Enter the part number of the
```

```
desired headphones: ";
18     cin >> partNum;
19     cout << fixed << showpoint <<
setprecision(2);
20
21     if (partNum == "S147-29A")
22         cout << "The price is $" << APRICE << endl;
23     else if (partNum == "S147-29B")
24         cout << "The price is $" << BPRICE << endl;
25     else
26         cout << partNum << " is not a valid part
number.\n";
27     return 0;
28 }
```

**Program Output with Example Input Shown in Bold**

```
The headphone part numbers are:  
    Noise canceling, part number S147-  
29A  
    Wireless, part number S147-29B  
Enter the part number of the desired  
headphones: S147-29B Enter  
The price is $199.00
```

You may also use relational operators to sort `string` objects.

**Program 10-18**  demonstrates this.

## Program 10-18

```
1 // This program uses relational operators to
alphabetically
2 // sort two strings entered by the user.
3 #include <iostream>
4 #include <string>
5 using namespace std;
6
7 int main ()
8 {
9     string name1, name2;
10
11     // Get a name.
12     cout << "Enter a name (last name first):
";
13     getline(cin, name1);
14
15     // Get another name.
16     cout << "Enter another name: ";
17     getline(cin, name2);
18
19     // Display them in alphabetical order.
20     cout << "Here are the names sorted
alphabetically:\n";
```

```
21     if (name1 < name2)
22         cout << name1 << endl << name2 <<
endl;
23     else if (name1 > name2)
24         cout << name2 << endl << name1 <<
endl;
25     else
26         cout << "You entered the same name
twice!\n";
27     return 0;
28 }
```

### Program Output with Example Input Shown in Bold

```
Enter a name (last name first): Smith,
Richard Enter
Enter another name: Jones, John Enter
Here are the names sorted alphabetically:
Jones, John
Smith, Richard
```



# Other Ways to Define `string` Objects

There are a variety of ways to initialize a `string` object when you define it. [Table 10-7](#) shows several example definitions and describes each. [Program 10-19](#) demonstrates a `string` object initialized with the string “William Smith.”

## Table 10-7 Examples of `string` Object Definitions

## Program 10-19

```
1 // This program initializes a string object.
2 #include <iostream>
3 #include <string>
4 using namespace std;
5
6 int main()
7 {
8     string greeting;
9     string name("William Smith");
10
11     greeting = "Hello ";
12     cout << greeting << name << endl;
13     return 0;
14 }
```

## Program Output

```
Hello William Smith
```

Notice in [Program 10-19](#) the use of the `=` operator to assign a value to the `string` object (line 11). The `string` class supports several operators, which are described in [Table 10-8](#).

#### Table 10-8 `string` Class Operators

[Program 10-20](#) demonstrates some of the `string` operators.

## Program 10-20

```
1 // This program demonstrates the C++ string
class.
2 #include <iostream>
3 #include <string>
4 using namespace std;
5
6 int main ()
7 {
8     // Define three string objects.
9     string str1, str2, str3;
10
11     // Assign values to all three.
12     str1 = "ABC";
13     str2 = "DEF";
14     str3 = str1 + str2;
15
16     // Display all three.
17     cout << str1 << endl;
18     cout << str2 << endl;
19     cout << str3 << endl;
20
21     // Concatenate a string onto str3 and
display it.
```

```
22     str3 += "GHI";  
23     cout << str3 << endl;  
24     return 0;  
25 }
```

## Program Output

```
ABC  
DEF  
ABCDEF  
ABCDEFGHI
```

# Using `string` Class Member Functions

The `string` class also has member functions. For example, the `length` member function returns the length of the string stored in the object. The value is returned as an unsigned integer.

Assume the following `string` object definition exists in a program:

```
string town = "Charleston";
```

The following statement in the same program would assign the value 10 to the variable `x`.

```
x = town.length();
```


**Program 10-21**  further demonstrates the `length` member function.

## Program 10-21

```
1 // This program demonstrates a string
2 // object's length member function.
3 #include <iostream>
4 #include <string>
5 using namespace std;
6
7 int main ()
8 {
9     string town;
10
11     cout << "Where do you live? ";
12     cin >> town;
13     cout << "Your town's name has " <<
town.length() ;
14     cout << " characters\n";
15     return 0;
16 }
```

**Program Output with Example Input Shown in Bold**

```
Where do you live? Jacksonville Enter  
Your town's name has 12 characters
```

The `size` function also returns the length of the string. It is demonstrated in the `for` loop in [Program 10-22](#) .




## Program 10-22

```
1 // This program demonstrates the C++ string
class.
2 #include <iostream>
3 #include <string>
4 using namespace std;
5
6 int main()
7 {
8     // Define three string objects.
9     string str1, str2, str3;
10
11     // Assign values to all three.
12     str1 = "ABC";
13     str2 = "DEF";
14     str3 = str1 + str2;
15
16     // Use subscripts to display str3 one
character
17     // at a time.
18     for (int x = 0; x < str3.size(); x++)
19         cout << str3[x];
20     cout << endl;
21
```

```
22     // Compare str1 with str2.
23     if (str1 < str2)
24         cout << "str1 is less than str2\n";
25     else
26         cout << "str1 is not less than
str2\n";
27     return 0;
28 }
```

### Program Output

```
ABCDEF
str1 is less than str2
```

**Table 10-9**  lists many of the `string` class member functions and their overloaded variations. In the examples, assume `mystring` is the name of a `string` object.

### Table 10-9 `string` Class Member Functions



In the

## Spotlight:

### String Tokenizing

Sometimes a string will contain a series of words or other items of data separated by spaces or other characters. For example, look at the following string:

```
"peach raspberry strawberry vanilla"
```

This string contains the following four items of data: `peach`, `raspberry`, `strawberry`, and `vanilla`. In programming terms, items such as these are known as *tokens*. Notice a space appears between the items. The character that separates tokens is known as a *delimiter*. Here is another example:

```
"17;92;81;12;46;5"
```

This string contains the following tokens: `17`, `92`, `81`, `12`, `46`, and `5`. Notice a semicolon appears between each item. In this example, the semicolon is used as a delimiter. Some programming problems require you to read a string that contains a list of items then extract all of the tokens from the

string for processing. For example, look at the following string that contains a date:

```
"3-22-2018"
```

The tokens in this string are `3`, `22`, and `2018`, and the delimiter is the hyphen character. Perhaps a program needs to extract the month, day, and year from such a string. Another example is an operating system pathname, such as the following:

```
/home/rsullivan/data
```

The tokens in this string are `home`, `rsullivan`, and `data`, and the delimiter is the `'/'` character. Perhaps a program needs to extract all of the directory names from such a pathname. The process of breaking a string into tokens is known as *tokenizing*, or *splitting* a string.

The following function, `split`, shows an example of how we can split a string into tokens. The function has three parameters:

- `s`—the string that we want to split into tokens
- `delim`—the character that is used as a delimiter
- `tokens`—a `vector` that will hold the tokens once they are extracted

```
1 void split(const string& s, char delim,
vector<string>& tokens)
2 {
3     int tokenStart = 0; // Starting position of the
next token
4
5     // Find the first occurrence of the delimiter.
6     int delimPosition = s.find(delim);
7
8     // While we haven't run out of delimiters...
9     while (delimPosition != string::npos)
10    {
11        // Extract the token.
12        string tok = s.substr(tokenStart, delimPosition
- tokenStart);
13
14        // Push the token onto the tokens vector.
15        tokens.push_back(tok);
16
17        // Move delimPosition to the next character
position.
18        delimPosition++;
19
20        // Move tokenStart to delmiPosition.
21        tokenStart = delimPosition;
22
23        // Find the next occurrence of the delimiter.
```

```

24     delimPosition = s.find(delim, delimPosition);
25
26     // If no more delimiters, extract the last
token.
27     if (delimPosition == string::npos)
28     {
29         // Extract the token.
30         string tok = s.substr(tokenStart,
delimPosition - tokenStart);
31
32         // Push the token onto the vector.
33         tokens.push_back(tok);
34     }
35 }
36 }

```

Let's take a closer look at the code:

- The `tokenStart` variable defined in line 3 will be used to hold the starting position of the next token. This variable is initialized with 0, assuming the first token starts at position 0.
- In line 6, we call the `s.find()` function, passing `delim` as an argument. The function will return the position of the first occurrence of `delim` in `s`. That value is assigned to the `delimPosition` variable. Note if the `find()` member function does not find the specified delimiter, it will return

the special constant `string::npos` (which is defined as `-1`).

- The `while` loop that begins in line 9 iterates as long as `delimPosition` is not equal to `string::npos`.
- Inside the `while` loop, line 12 extracts the substring beginning at `tokenStart`, and continuing up to the delimiter. The substring, which is a token, is assigned to the `tok` object.
- In line 15, we push the `tok` object to the back of the `tokens` vector.
- Now we are ready to find the next token. Line 18 increments `delimPosition`, and line 21 sets `tokenStart` to the same value as `delimPosition`.
- Line 24 calls the `s.find()` function, passing `delim` and `delimPosition` as arguments. The function will return the position of the next occurrence of `delim`, appearing at or after `delimPosition`. That value is assigned to the `delimPosition` variable. If the specified delimiter is not found, the `find()` member function will return the constant `string::npos`. When that happens in this statement, it means we are processing the last token in the string.
- The `if` statement that starts in line 27 determines whether `delimPosition` is equal to `string::npos`. As previously stated, if this is true, it means we are processing the last token. If that is the case, line 30

extracts the token and assigns it to `tok`, and line 33 pushes `tok` to the back of the `tokens` vector.

**Program 10-23**  demonstrates the `split` function.



## Program 10-23

```
1  #include <iostream>
2  #include <string>
3  #include <vector>
4  using namespace std;
5
6  // Function prototype
7  void split(const string&, char,
vector<string>&);
8
9  int main()
10 {
11     // Strings to tokenize
12     string str1 = "one two three four";
13     string str2 = "10:20:30:40:50";
14     string str3 = "a/b/c/d/e/f";
15
16     // vector to hold the tokens.
17     vector<string> tokens;
18
19     // Tokenize str1, using ' ' as the
delimiter.
20     split(str1, ' ', tokens);
```

```
21     for (auto e : tokens)
22         cout << e << " ";
23     cout << endl;
24     tokens.clear();
25
26     // Tokenize str2, using ':' as the
delimiter.
27     split(str2, ':', tokens);
28     for (auto e : tokens)
29         cout << e << " ";
30     cout << endl;
31     tokens.clear();
32
33     // Tokenize str3, using '/' as the
delimiter.
34     split(str3, '/', tokens);
35     for (auto e : tokens)
36         cout << e << " ";
37     cout << endl;
38     return 0;
39 }
40
41 The split function is not shown here.
42
```

## Program Output

```
one two three four
```

```
10 20 30 40 50
```

```
a b c d e f
```

# 10.8 Focus on Problem Solving and Program Design: A Case Study

As a programmer for the Home Software Company, you are asked to develop a function named `dollarFormat` that inserts commas and a \$ sign at the appropriate locations in a `string` object containing an unformatted dollar amount. As an argument, the function should accept a reference to a `string` object. You may assume the `string` object contains a value such as 1084567.89. The function should modify the `string` object so it contains a formatted dollar amount, such as \$1,084,567.89.

The code for the `dollarFormat` function is as follows:

```

void dollarFormat(string &currency)
{
    int dp;

    dp = currency.find('.');    // Find decimal point

    if (dp > 3)                // Insert commas
    {
        for (int x = dp - 3; x > 0; x -= 3)
            currency.insert(x, ",");
    }

    currency.insert(0, "$");    // Insert dollar sign
}

```

The function defines an `int` variable named `dp`. This variable is used to hold the position of the unformatted number's decimal point. This is accomplished with the statement:

```
dp = currency.find('.');
```


The `string` class's `find` member function returns the position number in the string where the '.' character is found. An `if` statement determines if the number has more than three numbers preceding the decimal point:

```
if (dp > 3)
```

If the decimal point is at a position greater than 3, then the function inserts commas in the string with the following loop:

```
for (int x = dp - 3; x > 0; x -= 3)  
    currency.insert(x, ",");
```

Finally, a \$ symbol is inserted at position 0 (the first character in the `string`).

**Program 10-24**  demonstrates the function.

## Program 10-24

```
1 // This program lets the user enter a number.
The
2 // dollarFormat function formats the number as
3 // a dollar amount.
4 #include <iostream>
5 #include <string>
6 using namespace std;
7
8 // Function prototype
9 void dollarFormat(string &);
10
11 int main ()
12 {
13     string input;
14
15     // Get the dollar amount from the user.
16     cout << "Enter a dollar amount in the
form nnnnn.nn : ";
17     cin >> input;
18     dollarFormat(input);
19     cout << "Here is the amount
formatted:\n";
20     cout << input << endl;
```

```
21     return 0;
22 }
23
24
//*****
*****
25 // Definition of the dollarFormat function.
This function *
26 // accepts a string reference object, which is
assumed *
27 // to hold a number with a decimal point. The
function *
28 // formats the number as a dollar amount with
commas and *
29 // a $ symbol.
*
30
//*****
*****
31
32 void dollarFormat(string &currency)
33 {
34     int dp;
35
36     dp = currency.find('.'); // Find
decimal point
37     if (dp > 3) // Insert
```



```
commas
38     {
39         for (int x = dp - 3; x > 0; x -= 3)
40             currency.insert(x, ",");
41     }
42     currency.insert(0, "$");    // Insert
dollar sign
43 }
```

### Program Output with Example Input Shown in Bold

```
Enter a dollar amount in the form nnnnn.nn:
1084567.89 Enter
Here is the amount formatted:
$1,084,567.89
```

# Review Questions and Exercises

## Short Answer

1. What header file must you include in a program using character-testing functions such as `isalpha` and `isdigit`?
2. What header file must you include in a program using the character conversion functions `toupper` and `tolower`?
3. Assume `c` is a `char` variable. What value does `c` hold after each of the following statements executes?
4. Look at the following code. What value will be stored in `s` after the code executes?

```
char name[10];  
  
int s;  
  
strcpy(name, "Jimmy");  
  
s = strlen(name);
```

5. What header file must you include in a program using string functions such as `strlen` and `strcpy`?
6. What header file must you include in a program using string/numeric conversion functions such as `atoi` and `atof`?

7. What header file must you include in a program using `string` class objects?
8. How do you compare `string` class objects?

# Fill-in-the-Blank

9. The \_\_\_\_\_ function returns `true` if the character argument is uppercase.
10. The \_\_\_\_\_ function returns `true` if the character argument is a letter of the alphabet.
11. The \_\_\_\_\_ function returns `true` if the character argument is a digit.
12. The \_\_\_\_\_ function returns `true` if the character argument is a whitespace character.
13. The \_\_\_\_\_ function returns the uppercase equivalent of its character argument.
14. The \_\_\_\_\_ function returns the lowercase equivalent of its character argument.
15. The \_\_\_\_\_ file must be included in a program that uses character-testing functions.
16. The \_\_\_\_\_ function returns the length of a string.
17. To \_\_\_\_\_ two strings means to append one string to the other.
18. The \_\_\_\_\_ function concatenates two strings.
19. The \_\_\_\_\_ function copies one string to another.
20. The \_\_\_\_\_ function searches for a string inside of another one.
21. The \_\_\_\_\_ function compares two strings.
22. The \_\_\_\_\_ function copies, at most,  $n$  number of characters from one string to another.

23. The \_\_\_\_\_ function returns the value of a string converted to an integer.
24. The \_\_\_\_\_ function returns the value of a string converted to a long integer.
25. The \_\_\_\_\_ function returns the value of a string converted to a float.
26. The \_\_\_\_\_ function converts an integer to a string.

# Algorithm Workbench

27. The following `if` statement determines whether `choice` is equal to `'Y'` or `'y'`:

```
if (choice == 'Y' || choice == 'y')
```

Simplify this statement by using either the `toupper` or `tolower` function.

28. Assume `input` is a `char` array holding a C-string. Write code that counts the number of elements in the array that contain an alphabetic character.

29. Look at the following array definition:

```
char str[10];
```

Assume `name` is also a `char` array, and it holds a C-string.

Write code that copies the contents of `name` to `str` if the C-string in `name` is not too big to fit in `str`.

30. Look at the following statements:

```
char str[] = "237.89";
```

```
double value;
```

Write a statement that converts the string in `str` to a `double` and stores the result in `value`.

31. Write a function that accepts a pointer to a C-string as its argument. The function should count the number of times the character 'w' occurs in the argument and return that number.
32. Assume `str1` and `str2` are string class objects. Write code that displays "They are the same!" if the two objects contain the same string.

# True or False

33. T F Character-testing functions, such as `isupper`, accept strings as arguments and test each character in the string.
34. T F If `toupper`'s argument is already uppercase, it is returned as is, with no changes.
35. T F If `tolower`'s argument is already lowercase, it will be inadvertently converted to uppercase.
36. T F The `strlen` function returns the size of the array containing a string.
37. T F If the starting address of a C-string is passed into a pointer parameter, it can be assumed that all the characters, from that address up to the byte that holds the null terminator, are part of the string.
38. T F C-string-handling functions accept as arguments pointers to strings (array names or pointer variables), or literal strings.
39. T F The `strcat` function checks to make sure the first string is large enough to hold both strings before performing the concatenation.
40. T F The `strcpy` function will overwrite the contents of its first string argument.
41. T F The `strcpy` function performs no bounds checking on the first argument.
42. T F There is no difference between "847" and 847.

# Find the Errors

Each of the following programs or program segments has errors. Find as many as you can.

43. 

```
char str[] = "Stop";  
if (isupper(str) == "STOP")  
    exit(0);
```

44. 

```
char numeric[5];  
int x = 123;  
numeric = atoi(x);
```

45. 

```
char string1[] = "Billy";  
char string2[] = " Bob Jones";  
strcat(string1, string2);
```

46. 

```
char x = 'a', y = 'a';  
if (strcmp(x, y) == 0)  
    exit(0);
```



# Programming Challenges

## 1. String Length

Write a function that returns an integer and accepts a pointer to a C-string as an argument. The function should count the number of characters in the string and return that number. Demonstrate the function in a simple program that asks the user to input a string, passes it to the function, then displays the function's return value.



## Solving the Backward String Problem

## 2. Backward String

Write a function that accepts a pointer to a C-string as an argument and displays its contents backward. For instance, if the string argument is `"Gravity"` the function should display `"ytivarG"`. Demonstrate the function in a program that asks the user to input a string then passes it to the function.

## 3. Word Counter

Write a function that accepts a pointer to a C-string as an argument and returns the number of words contained in the string. For instance, if the string argument is “Four score and seven years ago” the function should return the number 6. Demonstrate the function in a program that asks the user to input a string then passes it to the function. The number of words in the string should be displayed on the screen.

*Optional Exercise:* Write an overloaded version of this function that accepts a `string` class object as its argument.

#### 4. **Average Number of Letters**

Modify the program you wrote for Programming Challenge 3 (Word Counter), so it also displays the average number of letters in each word.

#### 5. **Sentence Capitalizer**

Write a function that accepts a pointer to a C-string as an argument and capitalizes the first character of each sentence in the string. For instance, if the string argument is "`hello. my name is Joe. what is your name?`" the function should manipulate the string so that it contains "`Hello. My name is Joe. What is your name?`" Demonstrate the function in a program that asks the user to input a string then passes it to the function. The modified string should be displayed on the screen. *Optional Exercise:* Write an overloaded version of this function that accepts a `string` class object as its argument.

#### 6. **Vowels and Consonants**

Write a function that accepts a pointer to a C-string as its argument. The function should count the number of vowels appearing in the string and return that number.

Write another function that accepts a pointer to a C-string as its argument. This function should count the number of consonants appearing in the string and return that number. Demonstrate these two functions in a program that performs the following steps:

1. The user is asked to enter a string.
2. The program displays the following menu:
  - A. Count the number of vowels in the string
  - B. Count the number of consonants in the string
  - C. Count both the vowels and consonants in the string
  - D. Enter another string
  - E. Exit the program
3. The program performs the operation selected by the user and repeats until the user selects E to exit the program.

## 7. Name Arranger

Write a program that asks for the user's first, middle, and last names. The names should be stored in three different character arrays. The program should then store, in a fourth array, the name arranged in the following manner: the last name followed by a comma and a space, followed by the first name and a space, followed by the middle name. For example, if the user entered "`Carol Lynn Smith`", it should store "`Smith, Carol Lynn`" in the fourth array. Display the contents of the fourth array on the screen.

## 8. Sum of Digits in a String

Write a program that asks the user to enter a series of single-digit numbers with nothing separating them. Read the input as a C-string or a `string` object. The program should display the sum of all the single-digit numbers in the string. For example, if the user enters 2514, the program should display 12, which is the sum of 2, 5, 1, and 4. The program should also display the highest and lowest digits in the string.

### 9. Most Frequent Character

Write a function that accepts either a pointer to a C-string, or a `string` object, as its argument. The function should return the character that appears most frequently in the string. Demonstrate the function in a complete program.

### 10. `replaceSubstring` Function

Write a function named `replaceSubstring`. The function should accept three C-string or `string` object arguments. Let's call them *string1*, *string2*, and *string3*. It should search *string1* for all occurrences of *string2*. When it finds an occurrence of *string2*, it should replace it with *string3*. For example, suppose the three arguments have the following values:

With these three arguments, the function would return a `string` object with the value "that dog jumped over that fence." Demonstrate the function in a complete program.

### 11. Case Manipulator

Write a program with three functions: `upper`, `lower`, and `reverse`. The `upper` function should accept a pointer to a C-string as an argument. It should step through each character

in the string, converting it to uppercase. The `lower` function, too, should accept a pointer to a C-string as an argument. It should step through each character in the string, converting it to lowercase. Like `upper` and `lower`, `reverse` should also accept a pointer to a string. As it steps through the string, it should test each character to determine whether it is uppercase or lowercase. If a character is uppercase, it should be converted to lowercase. Likewise, if a character is lowercase, it should be converted to uppercase. Test the functions by asking for a string in function `main`, then passing it to them in the following order: `reverse`, `lower`, and `upper`.

## 12. Password Verifier

Imagine you are developing a software package that requires users to enter their own passwords. Your software requires that users' passwords meet the following criteria:

- The password should be at least six characters long.
- The password should contain at least one uppercase and at least one lowercase letter.
- The password should have at least one digit.

Write a program that asks for a password then verifies that it meets the stated criteria. If it doesn't, the program should display a message telling the user why.

## 13. Date Printer

Write a program that reads a string from the user containing a date in the form mm/dd/yyyy. It should print the date in the form March 12, 2018.

#### 14. **Word Separator**

Write a program that accepts as input a sentence in which all of the words are run together, but the first character of each word is uppercase. Convert the sentence to a string in which the words are separated by spaces and only the first word starts with an uppercase letter. For example, the string “StopAndSmellTheRoses.” would be converted to “Stop and smell the roses.”

#### 15. **Character Analysis**

If you have downloaded this book’s source code, you will find a file named `text.txt` in the **Chapter 10** folder. Write a program that reads the file’s contents and determines the following:

- The number of uppercase letters in the file
- The number of lowercase letters in the file
- The number of digits in the file

#### 16. **Pig Latin**

Write a program that reads a sentence as input and converts each word to “Pig Latin.” In one version, to convert a word to Pig Latin, you remove the first letter and place that letter at the end of the word. Then you append the string “ay” to the word. Here is an example:

#### 17. **Morse Code Converter**

Morse code is a code where each letter of the English alphabet, each digit, and various punctuation characters are represented by a series of dots and dashes. **Table 10-10** shows part of the code.

Write a program that asks the user to enter a string then converts that string to Morse code.

## 18. Phone Number List

Write a program that has an array of at least 10 `string` objects that hold people's names and phone numbers. You may make up your own strings, or use the following:

```
"Alejandra Cruz, 555-1223"  
"Joe Looney, 555-0097"  
"Geri Palmer, 555-8787"  
"Li Chen, 555-1212"  
"Holly Gaddis, 555-8878"  
"Sam Wiggins, 555-0998"  
"Bob Kain, 555-8712"  
"Tim Haynes, 555-7676"  
"Warren Gaddis, 555-9037"  
"Jean James, 555-4939"  
"Ron Palmer, 555-2783"
```

The program should ask the user to enter a name or partial name to search for in the array. Any entries in the array that match the string entered should be displayed. For example, if the user enters "`Palmer`" the program should display the following names from the list:

```
Geri Palmer, 555-8787  
Ron Palmer, 555-2783
```

## 19. Check Writer

Write a program that displays a simulated paycheck. The program should ask the user to enter the date, the payee's name, and the amount of the check (up to \$10,000). It should then display a simulated check with the dollar amount spelled out, as shown here:

One thousand nine hundred twenty and 85 cents

Be sure to format the numeric value of the check in fixed-point notation with two decimal places of precision. Be sure the decimal place always displays, even when the number is zero or has no fractional part. Use either C-strings or `string` class objects in this program.

*Input Validation: Do not accept negative dollar amounts, or amounts over \$10,000.*

## 20. Lottery Statistics

To play the PowerBall lottery, you buy a ticket that has five numbers in the range of 1–69, and a “PowerBall” number in the range of 1-26. (You can pick the numbers yourself, or you can let the ticket machine randomly pick them for you.) Then, on a specified date, a winning set of numbers are randomly selected by a machine. If your first five numbers match the first five winning numbers in any order, and your PowerBall number matches the winning PowerBall number, then you win the jackpot, which is a very large amount of money. If your numbers match only some of the winning numbers, you win a lesser amount, depending on how many of the winning numbers you have matched.



In the student sample programs for this book, you will find a file named `pbnumbers.txt`, containing the winning lottery numbers that were selected between February 3, 2010 and May 11, 2016 (the file contains 654 sets of winning numbers). Here is an example of the first few lines of the file's contents:

```
17 22 36 37 52 24
14 22 52 54 59 04
05 08 29 37 38 34
10 14 30 40 51 01
07 08 19 26 36 15
```

*and so on ...*

Each line in the file contains the set of six numbers that were selected on a given date. The numbers are separated by a space, and the last number in each line is the PowerBall number for that day. For example, the first line in the file shows the numbers for February 3, 2010, which are 17, 22, 36, 37, 52, and the PowerBall number 24.

Write one or more programs that work with this file to perform the following:

- Display the 10 most common numbers, ordered by frequency.
- Display the 10 least common numbers, ordered by frequency.
- Display the 10 most overdue numbers (numbers that haven't been drawn in a long time), ordered from most overdue to least overdue.

- Display the frequency of each number 1-69, and the frequency of each Powerball number 1-26.

**Table 10-10 Morse Code**

---

# Chapter 11 Structured Data

---

## Topics

**11.1 Abstract Data Types** 

**11.2 Structures** 

**11.3 Accessing Structure Members** 

**11.4 Initializing a Structure** 

**11.5 Arrays of Structures** 

**11.6 Focus on Software Engineering: Nested Structures** 

**11.7 Structures as Function Arguments** 

**11.8 Returning a Structure from a Function** 

**11.9 Pointers to Structures** 

**11.10 Focus on Software Engineering: When to Use ., When to Use ->, and When to Use \*** 

**11.11 Enumerated Data Types** 

# 11.1 Abstract Data Types

## **Concept:**

Abstract data types (ADTs) are data types created by the programmer. ADTs have their own range (or domain) of data and their own sets of operations that may be performed on them.

The term *abstract data type*, or ADT, is very important in computer science and is especially significant in object-oriented programming. This chapter introduces you to the structure, which is one of C++'s mechanisms for creating abstract data types.

# Abstraction

An *abstraction* is a general model of something. It is a definition that includes only the general characteristics of an object. For example, the term “dog” is an abstraction. It defines a general type of animal. The term captures the essence of what all dogs are without specifying the detailed characteristics of any particular type of dog. According to *Webster’s New Collegiate Dictionary*, a dog is a highly variable carnivorous domesticated mammal (*Canis familiaris*) probably descended from the common wolf.

In real life, however, there is no such thing as a mere “dog.” There are specific types of dogs, each with its own set of characteristics. There are poodles, cocker spaniels, Great Danes, rottweilers, and many other breeds. There are small dogs and large dogs. There are gentle dogs and ferocious dogs. They come in all shapes, sizes, and dispositions. A real-life dog is not abstract. It is concrete.

# Data Types

C++ has several *primitive data types*, or data types that are defined as a basic part of the language, as shown in [Table 11-1](#).

## Table 11-1 Primitive Data Types

A data type defines what values a variable may hold. Each data type listed in [Table 11-1](#) has its own range of values, such as  $-32,768$  to  $+32,767$  for `short`s, and so forth. Data types also define what values a variable may not hold. For example, integer variables may not be used to hold fractional numbers.

In addition to defining a range or domain of values that a variable may hold, data types also define the operations that may be performed on a value. All of the data types listed in [Table 11-1](#) allow the following mathematical and relational operators to be used with them:

```
+ - * / > < >= <= == !=
```

Only the integer data types, however, allow operations with the modulus operator (%). So, a data type defines what values an object may hold, and the operations that may be performed on the object.

The primitive data types are abstract in the sense that a data type and a variable of that data type are not the same thing. For example, consider the following variable definition:

```
int x = 1, y = 2, z = 3;
```

In the statement above, the integer variables `x`, `y`, and `z` are defined. They are three separate instances of the data type `int`. Each variable has its own characteristics (`x` is set to 1, `y` is set to 2, and `z` is set to 3). In this example, the data type `int` is the abstraction, and the variables `x`, `y`, and `z` are concrete occurrences.

# Abstract Data Types

An abstract data type (ADT) is a data type created by the programmer and is composed of one or more primitive data types. The programmer decides what values are acceptable for the data type, as well as what operations may be performed on the data type. In many cases, the programmer designs his or her own specialized operations.

For example, suppose a program is created to simulate a 12-hour clock. The program could contain three ADTs: `Hours`, `Minutes`, and `Seconds`. The range of values for the `Hours` data type would be the integers 1 through 12. The range of values for the `Minutes` and `Seconds` data types would be 0 through 59. If an `Hours` object is set to 12 and then incremented, it will then take on the value 1. Likewise, if a `Minutes` object or a `Seconds` object is set to 59 then incremented, it will take on the value 0.

Abstract data types often combine several values. In the clock program, the `Hours`, `Minutes`, and `Seconds` objects could be combined to form a single `Clock` object. In this chapter, you will learn how to combine variables of primitive data types to form your own data structures, or ADTs.



## 11.2 Structures

### Concept:

C++ allows you to group several variables together into a single item known as a structure.

So far, you've written programs that keep data in individual variables. If you need to group items together, C++ allows you to create arrays. The limitation of arrays, however, is that all the elements must be of the same data type. Sometimes a relationship exists between items of different types. For example, a payroll system might keep the variables shown in [Table 11-2](#). These variables hold data for a single employee.

**Table 11-2 Variables in a Payroll System**




### Creating a Structure

All of the variables listed in [Table 11-2](#) are related because they can hold data about the same employee. Their definition statements, though, do not make it clear that they belong together. To create a relationship between variables, C++ gives you the ability to package them together into a *structure*.

Before a structure can be used, it must be declared. Here is the general format of a structure declaration:

```
struct tag
{
    variable declaration;
    // ... more declarations
    //     may follow...
};
```

The *tag* is the name of the structure. As you will see later, it's used like a data type name. The variable declarations that appear inside the braces declare *members* of the structure. Here is an example of a structure declaration that holds the payroll data listed in [Table 11-2](#) :

```
struct PayRoll
{
    int empNumber;    // Employee number
    string name;     // Employee's name
    double hours;    // Hours worked
    double payRate;  // Hourly pay rate
    double grossPay; // Gross pay
};
```

This declaration declares a structure named `PayRoll`. The structure has five members: `empNumber`, `name`, `hours`, `payRate`, and `grossPay`.

### **Warning!**

Notice a semicolon is required after the closing brace of the structure declaration.

### **Note:**

In this text, we begin the names of structure tags with an uppercase letter. This visually differentiates these names from the names of variables.



## Note:

The structure declaration shown contains three `double` members, each declared on a separate line. The three could also have been declared on the same line, as

```
struct PayRoll
{
    int empNumber;
    string name;
    double hours, payRate, grossPay;
};
```

Many programmers prefer to place each member declaration on a separate line, however, for increased readability.

It's important to note the structure declaration in our example does not define a variable. It simply tells the compiler what a `PayRoll` structure is made of. In essence, it creates a new data type named `PayRoll`. You can define variables of this type with simple definition statements, just as you would with any other data type. For example, the following statement defines a variable named `deptHead`:

```
PayRoll deptHead;
```

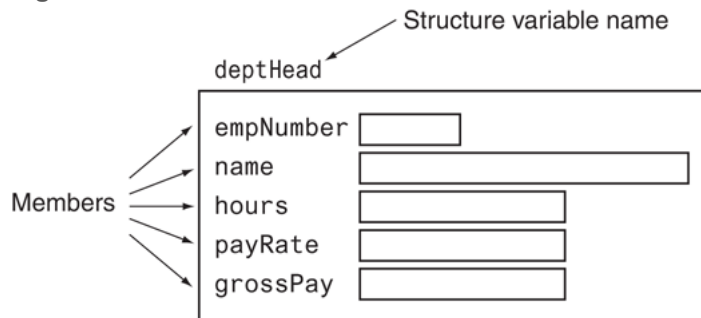
The data type of `deptHead` is the `PayRoll` structure. The structure tag, `PayRoll`, is listed before the variable name, just as the word `int` or `double` would be listed to define variables of those types.

Remember that structure variables are actually made up of other variables known as members. Because `deptHead` is a `PayRoll` structure, it contains the following members:

```
empNumber, an int
name, a string object
hours, a double
payRate, a double
grossPay, a double
```

Figure 11-1  illustrates this.

Figure 11-1 A structure and its members

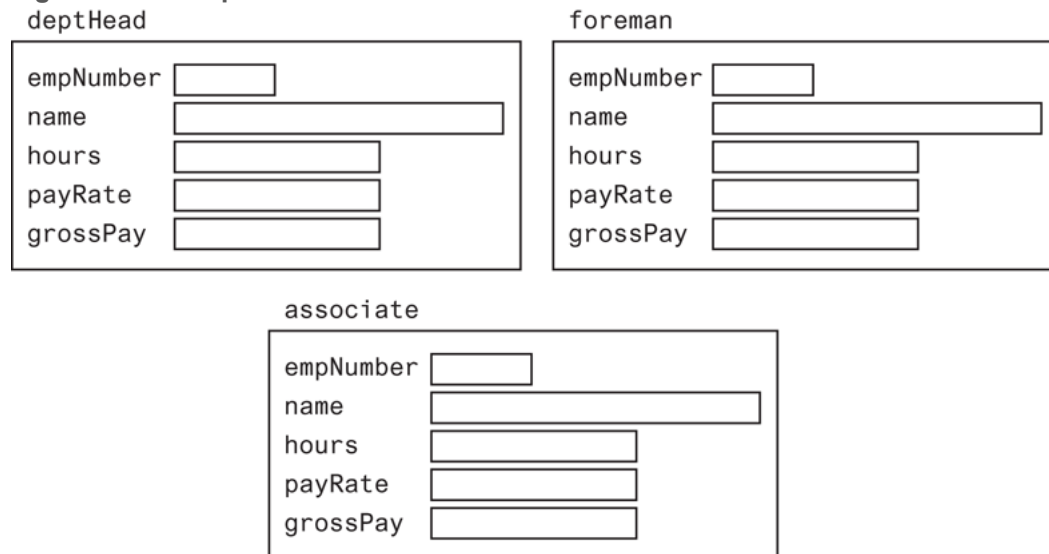


Just as it's possible to define multiple `int` or `double` variables, it's possible to define multiple structure variables in a program. The following statement defines three `PayRoll` variables: `deptHead`, `foreman`, and `associate`:

```
PayRoll deptHead, foreman, associate;
```

Figure 11-2  illustrates the existence of these three variables.

Figure 11-2 Multiple structure variables



Each of the variables defined in this example is a separate *instance* of the `PayRoll` structure and contains its own members. An instance of a structure is a variable that exists in memory. It contains within it all the members described in the structure declaration.

Although the structure variables in the example are separate, each contains members with the same name. (In the next section, you'll see how to access these members.) Here are some other examples of structure declarations and variable definitions:

```
struct Time          struct Date
{
    int hour;        int day;
    int minutes;     int month;
    int seconds;     int year;
};                  };
// Definition of the      // Definition of the structure
// structure variable now. // variable today.
Time now;              Date today;
```

In review, there are typically two steps to implementing structures in a program:

- Create the structure declaration. This establishes the tag (or name) of the structure and a list of items that are members.
- Define variables (or instances) of the structure and use them in the program to hold data.

# 11.3 Accessing Structure Members

## Concept:

The *dot operator* (.) allows you to access structure members in a program.

C++ provides the dot operator (a period) to access the individual members of a structure. Using our example of `deptHead` as a `PayRoll` structure variable, the following statement demonstrates how to access the `empNumber` member:

```
deptHead.empNumber = 475;
```

In this statement, the number 475 is assigned to the `empNumber` member of `deptHead`. The dot operator connects the name of the member variable with the name of the structure variable it belongs to. The following statements assign values to the `empNumber`

members of the `deptHead`, `foreman`, and `associate` structure variables:

```
deptHead.empNumber = 475;
foreman.empNumber = 897;
associate.empNumber = 729;
```

With the dot operator, you can use member variables just like regular variables. For example, these statements display the contents of `deptHead`'s members:

```
cout << deptHead.empNumber << endl;
cout << deptHead.name << endl;
cout << deptHead.hours << endl;
cout << deptHead.payRate << endl;
cout << deptHead.grossPay << endl;
```

**Program 11-1**  is a complete program that uses the `PayRoll` structure.

## Program 11-1

```
1 // This program demonstrates the use of
structures.
2 #include <iostream>
3 #include <string>
4 #include <iomanip>
5 using namespace std;
6
7 struct PayRoll
8 {
9     int empNumber;    // Employee number
10    string name;      // Employee's name
11    double hours;     // Hours worked
12    double payRate;   // Hourly payRate
13    double grossPay;  // Gross pay
14 };
15
16 int main()
17 {
18     PayRoll employee; // employee is a PayRoll
structure.
19
20     // Get the employee's number.
21     cout << "Enter the employee's number: ";
```



```
22     cin >> employee.empNumber;
23
24     // Get the employee's name.
25     cout << "Enter the employee's name: ";
26     cin.ignore(); // To skip the remaining
'\n' character
27     getline(cin, employee.name);
28
29     // Get the hours worked by the employee.
30     cout << "How many hours did the employee
work? ";
31     cin >> employee.hours;
32
33     // Get the employee's hourly pay rate.
34     cout << "What is the employee's hourly
payRate? ";
35     cin >> employee.payRate;
36
37     // Calculate the employee's gross pay.
38     employee.grossPay = employee.hours *
employee.payRate;
39
40     // Display the employee data.
41     cout << "Here is the employee's payroll
data:\n";
42     cout << "Name: " << employee.name << endl;
43     cout << "Number: " << employee.empNumber
```


```
<< endl;
44     cout << "Hours worked: " << employee.hours
<< endl;
45     cout << "Hourly payRate: " <<
employee.payRate << endl;
46     cout << fixed << showpoint <<
setprecision(2);
47     cout << "Gross Pay: $" <<
employee.grossPay << endl;
48     return 0;
49 }
```

**Program Output with Example Input Shown in Bold**

```
Enter the employee's number: 489 Enter
Enter the employee's name: Jill Smith Enter
How many hours did the employee work? 40
Enter
What is the employee's hourly pay rate? 20
Enter
Here is the employee's payroll data:
Name: Jill Smith
Number: 489
Hours worked: 40
Hourly pay rate: 20
Gross pay: $800.00
```



## Note:

**Program 11-1**  has the following call, in line 26, to `cin`'s `ignore` member function:

```
cin.ignore();
```

Recall that the `ignore` function causes `cin` to ignore the next character in the input buffer. This is necessary for the `getline` function to work properly in the program.



## Note:

The contents of a structure variable cannot be displayed by passing the entire variable to `cout`. For example, assuming `employee` is a `PayRoll` structure variable, the following statement will not work:

```
cout << employee << endl; // Will not work!
```

Instead, each member must be separately passed to `cout`

.

As you can see from [Program 11-1](#), structure members that are of a primitive data type can be used with `cin`, `cout`, mathematical statements, and any operation that can be performed with regular variables. The only difference is that the structure variable name and the dot operator must precede the name of a member. [Program 11-2](#) shows the member of a structure variable being passed to the `pow` function.

## Program 11-2

```
1 // This program stores data about a circle in
a structure.
2 #include <iostream>
3 #include <cmath> // For the pow function
4 #include <iomanip>
5 using namespace std;
6
7 // Constant for pi.
8 const double PI = 3.14159;
9
10 // Structure declaration
11 struct Circle
12 {
13     double radius; // A circle's radius
14     double diameter; // A circle's diameter
15     double area; // A circle's area
16 };
17
18 int main()
19 {
20     Circle c; // Define a structure
variable
21
```

```
22 // Get the circle's diameter.
23 cout << "Enter the diameter of a circle:
";
24 cin >> c.diameter;
25
26 // Calculate the circle's radius.
27 c.radius = c.diameter / 2;
28
29 // Calculate the circle's area.
30 c.area = PI * pow(c.radius, 2.0);
31
32 // Display the circle data.
33 cout << fixed << showpoint <<
setprecision(2);
34 cout << "The radius and area of the circle
are:\n";
35 cout << "Radius: " << c.radius << endl;
36 cout << "Area: " << c.area << endl;
37 return 0;
38 }
```

**Program Output with Example Input Shown in Bold**

```
Enter the diameter of a circle: 10 Enter  
The radius and area of the circle are:  
Radius: 5  
Area: 78.54
```

## Comparing Structure Variables

You cannot perform comparison operations directly on structure variables. For example, assume `circle1` and `circle2` are `Circle` structure variables. The following statement will cause an error:

```
if (circle1 == circle2) // Error!
```

In order to compare two structures, you must compare the individual members, as shown in the following code:

```
if (circle1.radius == circle2.radius &&  
    circle1.diameter == circle2.diameter &&  
    circle1.area == circle2.area)
```



## 11.4 Initializing a Structure

### Concept:

The members of a structure variable may be initialized with starting values when the structure variable is defined.

A structure variable may be initialized when it is defined, in a fashion similar to the initialization of an array. Assume the following structure declaration exists in a program:

```
struct CityInfo
{
    string cityName;
    string state;
    long population;
    int distance;
};
```

A variable may then be defined with an initialization list, as shown in the following:

```
CityInfo location = {"Asheville", "NC", 80000, 28};
```

This statement defines the variable `location`. The first value in the initialization list is assigned to the first declared member, the second value in the initialization list is assigned to the second member, and so on. The `location` variable is initialized in the following manner:

The string "Asheville" is assigned to `location.cityName`

The string "NC" is assigned to `location.state`

80000 is assigned to `location.population`

28 is assigned to `location.distance`

You do not have to provide initializers for all the members of a structure variable. For example, the following statement only initializes the `cityName` member of `location`:


```
CityInfo location = {"Tampa"};
```

The `state`, `population`, and `distance` members are left uninitialized. The following statement only initializes the `cityName` and `state` members, while leaving `population` and `distance` uninitialized:

```
CityInfo location = {"Atlanta", "GA"};
```

If you leave a structure member uninitialized, you must leave all the members that follow it uninitialized as well. C++ does not provide a way to skip members in a structure. For example, the following statement, which attempts to skip the initialization of the `population` member, is *not* legal:

```
CityInfo location = {"Knoxville", "TN", , 90}; // Illegal!
```

**Program 11-3**  demonstrates the use of partially initialized structure variables.

## Program 11-3

```
1 // This program demonstrates partially
  initialized
2 // structure variables.
3 #include <iostream>
4 #include <string>
5 #include <iomanip>
6 using namespace std;
7
8 struct EmployeePay
9 {
10     string name;           // Employee name
11     int empNum;           // Employee number
12     double payRate;       // Hourly pay rate
13     double hours;         // Hours worked
14     double grossPay;      // Gross pay
15 };
16
17 int main()
18 {
19     EmployeePay employee1 = {"Betty Ross",
141, 18.75};
20     EmployeePay employee2 = {"Jill Sandburg",
142, 17.50};
```

```
21
22     cout << fixed << showpoint <<
setprecision(2);
23
24     // Calculate pay for employee1
25     cout << "Name: " << employee1.name <<
endl;
26     cout << "Employee Number: " <<
employee1.empNum << endl;
27     cout << "Enter the hours worked by this
employee: ";
28     cin >> employee1.hours;
29     employee1.grossPay = employee1.hours *
employee1.payRate;
30     cout << "Gross Pay: " <<
employee1.grossPay << endl << endl;
31
32     // Calculate pay for employee2
33     cout << "Name: " << employee2.name <<
endl;
34     cout << "Employee Number: " <<
employee2.empNum << endl;
35     cout << "Enter the hours worked by this
employee: ";
36     cin >> employee2.hours;
37     employee2.grossPay = employee2.hours *
employee2.payRate;
```

```
38     cout << "Gross Pay: " <<
employee2.grossPay << endl;
39     return 0;
40 }
```

### Program Output with Example Input Shown in Bold

```
Name: Betty Ross
Employee Number: 141
Enter the hours worked by this employee: 40
Enter
Gross Pay: 750.00

Name: Jill Sandburg
Employee Number: 142
Enter the hours worked by this employee: 20
Enter
Gross Pay: 350.00
```

**11** Beginning with C++ 11, the = sign is optional when initializing a structure variable. For example, in C++ 11, we could define a `CityInfo` variable and initialize with the following statement:

```
CityInfo location {"Asheville", "NC", 80000, 28};
```



# Checkpoint

11.1 Write a structure declaration to hold the following data about a savings account:

Account Number ( `string` object)

Account Balance ( `double` )

Interest Rate ( `double` )

Average Monthly Balance ( `double` )

11.2 Write a definition statement for a variable of the structure you declared in Question 11.1. Initialize the members with the following data:

Account Number: ACZ42137-B12-7

Account Balance: \$4512.59

Interest Rate: 4%

Average Monthly Balance: \$4217.07

11.3 The following program skeleton, when complete, asks the user to enter these data about his or her favorite movie:

Name of movie

Name of the movie's director

Name of the movie's producer



The year the movie was released

Complete the following program by declaring the structure that holds this data, defining a structure variable, and writing the individual statements necessary.

```
#include <iostream>
using namespace std;
// Write the structure declaration here to hold the movie
data.
int main()
{
    // define the structure variable here.
    cout << "Enter the following data about your\n";
    cout << "favorite movie.\n";
    cout << "name: ";
    // Write a statement here that lets the user enter the
    // name of a favorite movie. Store the name in the
    // structure variable.
    cout << "Director: ";
    // Write a statement here that lets the user enter the
    // name of the movie's director. Store the name in the
    // structure variable.
    cout << "Producer: ";
    // Write a statement here that lets the user enter the
    // name of the movie's producer. Store the name in the
    // structure variable.
    cout << "Year of release: ";
    // Write a statement here that lets the user enter the
    // year the movie was released. Store the year in the
    // structure variable.
    cout << "Here is data on your favorite movie:\n";
    // Write statements here that display the data.
```

```
// just entered into the structure variable.  
return 0;  
}
```

## 11.5 Arrays of Structures

### **Concept:**

Arrays of structures can simplify some programming tasks.

In [Chapter 7](#), you saw that data can be stored in two or more arrays, with a relationship established between the arrays through their subscripts. Because structures can hold several items of varying data types, a single array of structures can be used in place of several arrays of regular variables.

An array of structures is defined like any other array. Assume the following structure declaration exists in a program:

```
struct BookInfo
{
    string title;
    string author;
    string publisher;
    double price;
};
```

The following statement defines an array, `bookList`, that has 20 elements. Each element is a `BookInfo` structure.


```
BookInfo bookList[20];
```

Each element of the array may be accessed through a subscript. For example, `bookList[0]` is the first structure in the array, `bookList[1]` is the second, and so forth. To access a member of any element, simply place the dot operator and member name after the subscript. For example, the following expression refers to the `title` member of `bookList[5]`:

```
bookList[5].title
```

The following loop steps through the array, displaying the data stored in each element:

```
for (int index = 0; index < 20; index++)  
{  
    cout << bookList[index].title << endl;  
    cout << bookList[index].author << endl;  
    cout << bookList[index].publisher << endl;  
    cout << bookList[index].price << endl << endl;  
}
```

**Program 11-4**  calculates and displays payroll data for three employees. It uses a single array of structures.

## Program 11-4

```
1 // This program uses an array of structures.
2 #include <iostream>
3 #include <iomanip>
4 using namespace std;
5
6 struct PayInfo
7 {
8     int hours;           // Hours worked
9     double payRate;     // Hourly pay rate
10 };
11
12 int main()
13 {
14     const int NUM_WORKERS = 3;    // Number
of workers
15     PayInfo workers[NUM_WORKERS]; // Array of
structures
16     int index;                   // Loop
counter
17
18     // Get employee pay data.
19     cout << "Enter the hours worked by " <<
NUM_WORKERS
```

```
20         << " employees and their hourly
rates.\n";
21
22     for (index = 0; index < NUM_WORKERS;
index++)
23     {
24         // Get the hours worked by an
employee.
25         cout << "Hours worked by employee #"
<< (index + 1);
26         cout << ": ";
27         cin >> workers[index].hours;
28
29         // Get the employee's hourly pay rate.
30         cout << "Hourly pay rate for employee
#";
31         cout << (index + 1) << ": ";
32         cin >> workers[index].payRate;
33         cout << endl;
34     }
35
36     // Display each employee's gross pay.
37     cout << "Here is the gross pay for each
employee:\n";
38     cout << fixed << showpoint <<
setprecision(2);
39     for (index = 0; index < NUM_WORKERS;
```



```
index++)  
40     {  
41         double gross;  
42         gross = workers[index].hours *  
workers[index].payRate;  
43         cout << "Employee #" << (index + 1);  
44         cout << ": $" << gross << endl;  
45     }  
46     return 0;  
47 }
```

**Program Output with Example Input Shown in Bold**

Enter the hours worked by 3 employees and their hourly rates.

Hours worked by employee #1: **10** Enter

Hourly pay rate for employee #1: **9.75** Enter

Hours worked by employee #2: **20** Enter

Hourly pay rate for employee #2: **10.00** Enter

Hours worked by employee #3: **40** Enter

Hourly pay rate for employee #3: **20.00** Enter

Here is the gross pay for each employee:

Employee #1: \$97.50

Employee #2: \$200.00

Employee #3: \$800.00

# Initializing a Structure Array

To initialize a structure array, simply provide an initialization list for one or more of the elements. For example, the array in [Program 11-4](#) could have been initialized as follows:

```
PayInfo workers[NUM_WORKERS] = {  
    {10, 9.75 },  
    {15, 8.62 },  
    {40, 15.65}  
};
```

As in all single-dimensional arrays, you can initialize all or part of the elements in an array of structures, as long as you do not skip elements.

# 11.6 Focus on Software Engineering: Nested Structures

**Concept:**

It's possible for a structure variable to be a member of another structure variable.

Sometimes it's helpful to nest structures inside other structures. For example, consider the following structure declarations:

```
struct Costs
{
    double wholesale;
    double retail;
};


struct Item
{
    string partNum;
    string description;
    Costs pricing;
};
```

The `Costs` structure has two members: `wholesale` and `retail`, both `doubles`. Notice the third member of the `Item` structure, `pricing`, is a `Costs` structure. Assume the variable `widget` is defined as follows:

```
Item widget;
```

The following statements show examples of accessing members of the `pricing` variable, which is inside `widget`:

```
widget.pricing.wholesale = 100.0;  
widget.pricing.retail = 150.0;
```

**Program 11-5**  gives a more elaborate illustration of nested structures.

## Program 11-5

```
1 // This program uses nested structures.
2 #include <iostream>
3 #include <string>
4 using namespace std;
5
6 // The Date structure holds data about a date.
7 struct Date
8 {
9     int month;
10    int day;
11    int year;
12 };
13
14 // The Place structure holds a physical
15 address.
16 struct Place
17 {
18     string address;
19     string city;
20     string state;
21     string zip;
22 }
```

```
23 // The EmployeeInfo structure holds an
employee's data.
24 struct EmployeeInfo
25 {
26     string name;
27     int employeeNumber;
28     Date birthDate;           // Nested
structure
29     Place residence;         // Nested
structure
30 };
31
32 int main()
33 {
34     // Define a structure variable to hold
info about the manager.
35     EmployeeInfo manager;
36
37     // Get the manager's name and employee
number
38     cout << "Enter the manager's name: ";
39     getline(cin, manager.name);
40     cout << "Enter the manager's employee
number: ";
41     cin >> manager.employeeNumber;
42
43     // Get the manager's birth date
```



```
44     cout << "Now enter the manager's date of
birth.\n";
45     cout << "Month (up to 2 digits): ";
46     cin >> manager.birthDate.month;
47     cout << "Day (up to 2 digits): ";
48     cin >> manager.birthDate.day;
49     cout << "Year: ";
50     cin >> manager.birthDate.year;
51     cin.ignore(); // Skip the remaining
newline character
52
53     // Get the manager's residence information
54     cout << "Enter the manager's street
address: ";
55     getline(cin, manager.residence.address);
56     cout << "City: ";
57     getline(cin, manager.residence.city);
58     cout << "State: ";
59     getline(cin, manager.residence.state);
60     cout << "ZIP Code: ";
61     getline(cin, manager.residence.zip);
62
63     // Display the information just entered
64     cout << "\nHere is the manager's
information:\n";
65     cout << manager.name << endl;
66     cout << "Employee number " <<
```

```
manager.employeeNumber << endl;
67     cout << "Date of birth: ";
68     cout << manager.birthDate.month << "-";
69     cout << manager.birthDate.day << "-";
70     cout << manager.birthDate.year << endl;
71     cout << "Place of residence:\n";
72     cout << manager.residence.address << endl;
73     cout << manager.residence.city << ", ";
74     cout << manager.residence.state << " ";
75     cout << manager.residence.zip << endl;
76     return 0;
77 }
```

**Program Output with Example Input Shown in Bold**

Enter the manager's name: **John Smith** Enter

Enter the manager's employee number: **789**

Enter

Now enter the manager's date of birth.

Month (up to 2 digits): **10** Enter

Day (up to 2 digits): **14** Enter

Year: **1970** Enter

Enter the manager's street address: **190 Disk Drive** Enter

City: **Redmond** Enter

State: **WA** Enter

ZIP Code: **98052** Enter

Here is the manager's information:

John Smith

Employee number 789

Date of birth: 10-14-1970

Place of residence:

190 Disk Drive

Redmond, WA 98052



For Questions 11.4–11.7 below, assume the `Product` structure is declared as follows:

```
struct Product
{
    string description; // Product description
    int partNum;       // Part number
    double cost;       // Product cost
};
```

11.4 Write a definition for an array of 100 `Product` structures.

Do not initialize the array.

11.5 Write a loop that will step through the entire array you defined in Question 11.4, setting all the product descriptions to an empty string, all part numbers to zero, and all costs to zero.

11.6 Write the statements that will store the following data in the first element of the array you defined in Question 11.4:

Description: Claw hammer

Part Number: 547

Part Cost: \$8.29

11.7 Write a loop that will display the contents of the entire array you created in Question 11.4.

11.8 Write a structure declaration named `Measurement`, with the following members:

`miles`, an integer

`meters`, a `long` integer

11.9 Write a structure declaration named `Destination`, with the following members:

`city`, a `string` object

`distance`, a `Measurement` structure (declared in Question 11.8)

Also define a variable of this structure type.

11.10 Write statements that store the following data in the variable you defined in Question 11.9:

City: Tupelo

Miles: 375

Meters: 603,375

## 11.7 Structures as Function Arguments

### Concept:

Structure variables may be passed as arguments to functions.



### Passing a Structure to a Function

Like other variables, the individual members of a structure variable may be used as function arguments. For example, assume the following structure declaration exists in a program:

```
struct Rectangle
{
    double length;
    double width;
    double area;
};
```

Let's say the following function definition exists in the same program:

```
double multiply(double x, double y)
{
    return x * y;
}
```

Assuming `box` is a variable of the `Rectangle` structure type, the following function call will pass `box.length` into `x` and `box.width` into `y`. The return value will be stored in `box.area`.

```
box.area = multiply(box.length, box.width);
```

Sometimes it's more convenient to pass an entire structure variable into a function instead of individual members. For example, the following function definition uses a `Rectangle` structure variable as its parameter:

```
void showRect(Rectangle r)
{
    cout << r.length << endl;
    cout << r.width << endl;
    cout << r.area << endl;
}
```

The following function call passes the `box` variable into `r`:

```
showRect(box);
```

Inside the function `showRect`, `r`'s members contain a copy of `box`'s members. This is illustrated in [Figure 11-3](#).

**Figure 11-3** Passing a structure variable to a function

```
showRect(box);
    |
    |
    v
void showRect(Rectangle r)
{
    cout << r.length << endl;
    cout << r.width << endl;
    cout << r.area << endl;
}
```

Once the function is called, `r.length` contains a copy of `box.length`, `r.width` contains a copy of `box.width`, and `r.area` contains a copy of `box.area`.

Structures, like all variables, are normally passed by value into a function. If a function is to access the members of the original argument, a reference variable may be used as the parameter. [Program 11-6](#) uses two functions that accept structures as arguments. Arguments are passed to the `getItem` function by reference, and to the `showItem` function by value.

## Program 11-6

```
1 // This program has functions that accept structure variables
2 // as arguments.
3 #include <iostream>
4 #include <string>
5 #include <iomanip>
6 using namespace std;
7
8 struct InventoryItem
9 {
10     int partNum;           // Part number
11     string description;    // Item description
12     int onHand;           // Units on hand
13     double price;        // Unit price
14 };
15
16 // Function Prototypes
17 void getItem(InventoryItem&); // Argument passed by reference
18 void showItem(InventoryItem); // Argument passed by value
19
20 int main()
21 {
22     InventoryItem part;
23
24     getItem(part);
25     showItem(part);
26     return 0;
27 }
28
29 /*******
30 // Definition of function getItem. This function uses
31 // a structure reference variable as its parameter. It asks
32 // the user for information to store in the structure.
33 /*******
34
35 void getItem(InventoryItem &p) // Uses a reference parameter
36 {
37     // Get the part number.
```



```

38     cout << "Enter the part number: ";
39     cin >> p.partNum;
40
41     // Get the part description.
42     cout << "Enter the part description: ";
43     cin.ignore(); // Ignore the remaining newline character
44     getline(cin, p.description);
45
46     // Get the quantity on hand.
47     cout << "Enter the quantity on hand: ";
48     cin >> p.onHand;
49
50     // Get the unit price.
51     cout << "Enter the unit price: ";
52     cin >> p.price;
53 }
54
55 //*****
56 // Definition of function showItem. This function accepts *
57 // an argument of the InventoryItem structure type. The *
58 // contents of the structure is displayed. *
59 //*****
60
61 void showItem(InventoryItem p)
62 {
63     cout << fixed << showpoint << setprecision(2);
64     cout << "Part Number: " << p.partNum << endl;
65     cout << "Description: " << p.description << endl;
66     cout << "Units On Hand: " << p.onHand << endl;
67     cout << "Price: $" << p.price << endl;
68 }

```

**Program Output with Example Input Shown in Bold**

```
Enter the part number: 800 Enter
Enter the part description: Screwdriver Enter
Enter the quantity on hand: 135 Enter
Enter the unit price: 1.25 Enter
Part Number: 800
Description: Screwdriver
Units on Hand: 135
Price: $1.25
```

Notice the `InventoryItem` structure declaration in [Program 11-6](#) appears before both the prototypes and the definitions of the `getItem` and `showItem` functions. This is because both functions use an `InventoryItem` structure variable as their parameter. The compiler must know what `InventoryItem` is before it encounters any definitions for variables of that type. Otherwise, an error will occur.

# Constant Reference Parameters

Sometimes structures can be quite large. Passing large structures by value can decrease a program's performance because a copy of the structure has to be created. When a structure is passed by reference, however, it isn't copied. A reference that points to the original argument is passed instead. So, it's often preferable to pass large objects such as structures by reference.

Of course, the disadvantage of passing an object by reference is that the function has access to the original argument. It can potentially alter the argument's value. This can be prevented, however, by passing the argument as a constant reference. The `showItem` function from [Program 11-6](#) is shown here, modified to use a constant reference parameter.

```
void showItem(const InventoryItem &p)
{
    cout << fixed << showpoint << setprecision(2);
    cout << "Part Number: " << p.partNum << endl;
    cout << "Description: " << p.description << endl;
    cout << "Units on Hand: " << p.onHand << endl;
    cout << "Price: $" << p.price << endl;
}
```

This version of the function is more efficient than the original version because the amount of time and memory consumed in the function call is reduced. Because the parameter is defined as a constant, the function cannot accidentally corrupt the value of the argument.


The prototype for this version of the function is as follows:

```
void showItem(const InventoryItem&);
```

# 11.8 Returning a Structure from a Function

## Concept:

A function may return a structure.

Just as functions can be written to return an `int`, `long`, `double`, or other data type, they can also be designed to return a structure. Recall the following structure declaration from [Program 11-2](#) :

```
struct Circle
{
    double radius;
    double diameter;
    double area;
};
```

A function, such as the following, could be written to return a variable of the `Circle` data type:

```
Circle getCircleData()
{
    Circle temp;           // Temporary Circle structure



    temp.radius = 10.0;   // Store the radius
    temp.diameter = 20.0; // Store the diameter
    temp.area = 314.159;  // Store the area
    return temp;         // Return the temporary structure
}
```

Notice the `getCircleData` function has a return data type of `Circle`. That means the function returns an entire `Circle` structure when it terminates. The return value can be assigned to any variable that is a `Circle` structure. The following statement, for example, assigns the function's return value to the `Circle` structure variable named `myCircle`:

```
myCircle = getCircleData();
```

After this statement executes, `myCircle.radius` will be set to 10.0, `myCircle.diameter` will be set to 20.0, and `myCircle.area` will be set to 314.159.

When a function returns a structure, it is always necessary for the function to have a local structure variable to hold the member values that are to be returned. In the `getCircleData` function, the values for `diameter`, `radius`, and `area` are stored in the local variable `temp`. The `temp` variable is then returned from the function.

**Program 11-7**  is a modification of **Program 11-2** . The function `getInfo` gets the circle's diameter from the user and calculates the circle's radius. The diameter and radius are stored in a local structure variable, `round`, which is returned from the function.

## Program 11-7

```
1 // This program uses a function to return a
  structure. This
2 // is a modification of Program 11-2.
3 #include <iostream>
4 #include <iomanip>
5 #include <cmath> // For the pow function
6 using namespace std;
7
8 // Constant for pi.
9 const double PI = 3.14159;
10
11 // Structure declaration
12 struct Circle
13 {
14     double radius; // A circle's radius
15     double diameter; // A circle's diameter
16     double area; // A circle's area
17 };
18
19 // Function prototype
20 Circle getInfo();
21
22 int main()
```

```

23  {
24      Circle c;          // Define a structure
variable
25
26      // Get data about the circle.
27      c = getInfo();
28
29      // Calculate the circle's area.
30      c.area = PI * pow(c.radius, 2.0);
31
32      // Display the circle data.
33      cout << "The radius and area of the circle
are:\n";
34      cout << fixed << setprecision(2);
35      cout << "Radius: " << c.radius << endl;
36      cout << "Area: " << c.area << endl;
37      return 0;
38  }
39
40
//*****
*****
41  // Definition of function getInfo. This
function uses a local *
42  // variable, tempCircle, which is a circle
structure. The user *
43  // enters the diameter of the circle, which is

```



```

stored in      *
44 // tempCircle.diameter. The function then
calculates the radius, *
45 // which is stored in tempCircle.radius.
tempCircle is then      *
46 // returned from the function.
*
47
/*****
*****
48
49 Circle getInfo()
50 {
51     Circle tempCircle; // Temporary structure
variable
52
53     // Store circle data in the temporary
variable.
54     cout << "Enter the diameter of a circle:
";
55     cin >> tempCircle.diameter;
56     tempCircle.radius = tempCircle.diameter /
2.0;
57
58     // Return the temporary variable.
59     return tempCircle;
60 }

```

## Program Output with Example Input Shown in Bold

```
Enter the diameter of a circle: 10 Enter  
The radius and area of the circle are:  
Radius: 5.00  
Area: 78.54
```



### Note:

In [Chapter 6](#), you learned that C++ only allows you to return a single value from a function. Structures, however, provide a way around this limitation. Even though a structure may have several members, a structure variable is a single value. By packaging multiple values inside a structure, you can return as many variables as you need from a function.

## 11.9 Pointers to Structures

### Concept:

You may take the address of a structure variable and create variables that are pointers to structures.

Defining a variable that is a pointer to a structure is as simple as defining any other pointer variable: The data type is followed by an asterisk and the name of the pointer variable. Here is an example:

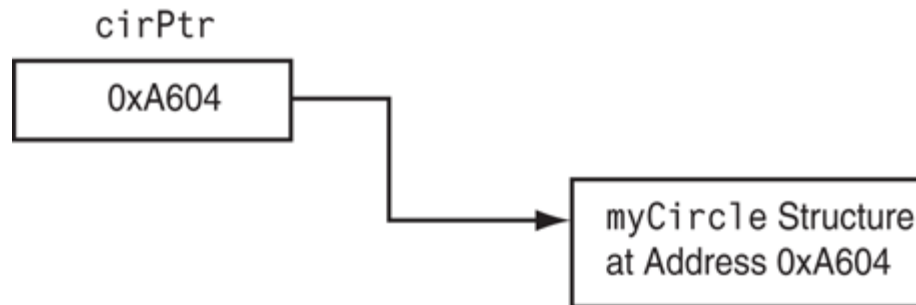
```
Circle *cirPtr = nullptr;
```

This statement defines `cirPtr` as a pointer to a `Circle` structure. Look at the following code:

```
Circle myCircle = { 10.0, 20.0, 314.159 };  
Circle *cirPtr = nullptr;  
cirPtr = &myCircle;
```

The first two lines define `myCircle`, a structure variable, and `cirPtr`, a pointer. The third line assigns the address of `myCircle` to `cirPtr`. After this line executes, `cirPtr` will point to the `myCircle` structure. This is illustrated in [Figure 11-4](#).

**Figure 11-4** A pointer to a structure



Indirectly accessing the members of a structure through a pointer can be clumsy, however, if the indirection operator is used. One might think the following statement would access the `radius` member of the structure pointed to by `cirPtr`, but it doesn't:

```
*cirPtr.radius = 10;
```

The dot operator has higher precedence than the indirection operator, so the indirection operator tries to dereference `cirPtr.radius`, not `cirPtr`. To dereference the `cirPtr` pointer, a set of parentheses must be used.

```
(*cirPtr).radius = 10;
```

Because of the awkwardness of this notation, C++ has a special operator for dereferencing structure pointers. It's called the *structure pointer operator*, and it consists of a hyphen (-) followed by the greater-than symbol (>). The previous statement, rewritten with the structure pointer operator, looks like this:


```
cirPtr->radius = 10;
```

The structure pointer operator takes the place of the dot operator in statements using pointers to structures. The operator automatically dereferences the structure pointer on its left. There is no need to enclose the pointer name in parentheses.



### Note:

The structure pointer operator is supposed to look like an arrow, thus visually indicating that a “pointer” is being used.

**Program 11-8**  shows that a pointer to a structure may be used as a function parameter, allowing the function to access the members of the original structure argument.

## Program 11-8

```
1 // This program demonstrates a function that
  uses a
2 // pointer to a structure variable as a
  parameter.
3 #include <iostream>
4 #include <string>
5 #include <iomanip>
6 using namespace std;
7
8 struct Student
9 {
10     string name;           // Student's name
11     int idNum;            // Student ID number
12     int creditHours;     // Credit hours
  enrolled
13     double gpa;          // Current GPA
14 };
15
16 void getData(Student *); // Function
  prototype
17
18 int main()
19 {
```

```

20     Student freshman;
21
22     // Get the student data.
23     cout << "Enter the following student
data:\n";
24     getData(&freshman);    // Pass the address
of freshman.
25     cout << "\nHere is the student data you
entered:\n";
26
27     // Now display the data stored in freshman
28     cout << setprecision(3);
29     cout << "Name: " << freshman.name << endl;
30     cout << "ID Number: " << freshman.idNum <<
endl;
31     cout << "Credit Hours: " <<
freshman.creditHours << endl;
32     cout << "GPA: " << freshman.gpa << endl;
33     return 0;
34 }
35
36
//*****
*****
37 // Definition of function getData. Uses a
pointer to a *
38 // Student structure variable. The user enters

```



```

student *
39 // information, which is stored in the
variable. *
40
//*****
*****
41
42 void getData(Student *s)
43 {
44     // Get the student name.
45     cout << "Student name: ";
46     getline(cin, s->name);
47
48     // Get the student ID number.
49     cout << "Student ID Number: ";
50     cin >> s->idNum;
51
52     // Get the credit hours enrolled.
53     cout << "Credit Hours Enrolled: ";
54     cin >> s->creditHours;
55
56     // Get the GPA.
57     cout << "Current GPA: ";
58     cin >> s->gpa;
59 }

```

**Program Output with Example Input Shown in Bold**

Enter the following student data:

Student Name: **Frank Smith** Enter

Student ID Number: **4876** Enter

Credit Hours Enrolled: **12** Enter

Current GPA: **3.45** Enter

Here is the student data you entered:

Name: Frank Smith

ID Number: 4876

Credit Hours: 12

GPA: 3.45

# Dynamically Allocating a Structure

You can also use a structure pointer and the `new` operator to dynamically allocate a structure. For example, the following code defines a `Circle` pointer named `cirPtr` and dynamically allocates a `Circle` structure. Values are then stored in the dynamically allocated structure's members.

```
Circle *cirPtr = nullptr; // Define a Circle pointer
cirPtr = new Circle;      // Dynamically allocate a Circle
                           structure
cirPtr->radius = 10;      // Store a value in the radius member
cirPtr->diameter = 20;   // Store a value in the diameter
                           member
cirPtr->area = 314.159;   // Store a value in the area member
```

You can also dynamically allocate an array of structures. The following code shows an array of five `Circle` structures being allocated:

```
Circle *circles = nullptr;
circles = new Circle[5];
for (int count = 0; count < 5; count++)
{
    cout << "Enter the radius for circle "
        << (count + 1) << ": ";
    cin >> circles[count].radius;
}
```

# 11.10 Focus on Software Engineering: When to Use ., When to Use ->, and When to Use \*

Sometimes structures contain pointers as members. For example, the following structure declaration has an `int` pointer member:

```
struct GradeInfo
{
    string name;           // Student names
    int *testScores;      // Dynamically allocated array
    float average;        // Test average
};
```

It is important to remember that the structure pointer operator (`->`) is used to dereference a pointer to a structure, not a pointer that is a member of a structure. If a program dereferences the `testScores` pointer in this structure, the indirection operator must be used. For example, assume that the following variable has been defined:

```
GradeInfo student1;
```

The following statement will display the value pointed to by the `testScores` member:

```
cout << *student1.testScores;
```

It is still possible to define a pointer to a structure that contains a pointer member. For instance, the following statement defines `stPtr` as a pointer to a `GradeInfo` structure:

```
GradeInfo *stPtr = nullptr;
```

Assuming `stPtr` points to a valid `GradeInfo` variable, the following statement will display the value pointed to by its `testScores` member:

```
cout << *stPtr->testScores;
```

In this statement, the `*` operator dereferences `stPtr->testScores`, while the `->` operator dereferences `stPtr`. It might help to

remember that the following expression:

```
stPtr->testScores
```

is equivalent to

```
(*stPtr).testScores
```

So, the expression

```
*stPtr->testScores
```

is the same as

```
*(*stPtr).testScores
```

The awkwardness of this last expression shows the necessity of the `->` operator. [Table 11-3](#) lists some expressions using the `*`, `->`, and `.` operators and describes what each references.

### Table 11-3 Structure Pointer Expressions



Assume the following structure declaration exists for Questions 11.11–11.15:

```
struct Rectangle
{
    int length;
    int width;
};
```

11.11 Write a function that accepts a `Rectangle` structure as its argument and displays the structure's contents on the screen.

11.12 Write a function that uses a `Rectangle` structure reference variable as its parameter and stores the user's input in the structure's members.

11.13 Write a function that returns a `Rectangle` structure. The function should store the user's input in the members of the structure before returning it.

11.14 Write the definition of a pointer to a `Rectangle` structure.

11.15 Assume `rptr` is a pointer to a `Rectangle` structure. Which of the expressions, A, B, or C, is equivalent to the following expression:



```
rptr->width
```

- A. `*rptr.width`
- B. `(*rptr).width`
- C. `rptr.(*width)`

# 11.11 Enumerated Data Types

## Concept:

An enumerated data type is a programmer-defined data type. It consists of values known as enumerators, which represent integer constants.

Using the `enum` key word, you can create your own data type and specify the values that belong to that type. Such a type is known as an *enumerated data type*. Here is an example of an enumerated data type declaration:

```
enum Day { MONDAY, TUESDAY, WEDNESDAY, THURSDAY, FRIDAY };
```

An enumerated type declaration begins with the key word `enum`, followed by the name of the type, followed by a list of identifiers inside braces, and is terminated with a semicolon. The example declaration creates an enumerated data type named `Day`. The identifiers `MONDAY`, `TUESDAY`, `WEDNESDAY`, `THURSDAY`, and `FRIDAY`, which are listed inside the braces, are known as *enumerators*. They

represent the values that belong to the `Day` data type. Here is the general format of an enumerated type declaration:

```
enum TypeName { One or more enumerators };
```

Note the enumerators are not enclosed in quotation marks; therefore, they are not strings. Enumerators must be legal C++ identifiers.

Once you have created an enumerated data type in your program, you can define variables of that type. For example, the following statement defines `workDay` as a variable of the `Day` type:

```
Day workDay;
```

Because `workDay` is a variable of the `Day` data type, we may assign any of the enumerators `MONDAY`, `TUESDAY`, `WEDNESDAY`, `THURSDAY`, or `FRIDAY` to it. For example, the following statement assigns the value `WEDNESDAY` to the `workDay` variable.

```
Day workDay = WEDNESDAY;
```

So just what are these enumerators `MONDAY`, `TUESDAY`, `WEDNESDAY`, `THURSDAY`, and `FRIDAY`? You can think of them as integer named constants. Internally, the compiler assigns integer values to the enumerators, beginning with 0. The enumerator `MONDAY` is stored in memory as the number 0, `TUESDAY` is stored in memory as the number 1, `WEDNESDAY` is stored in memory as the number 2, and so forth. To prove this, look at the following code.

```
cout << MONDAY << endl << TUESDAY << endl  
      << WEDNESDAY << endl << THURSDAY << endl  
      << FRIDAY << endl;
```

This statement will produce the following output:

0

1

2

3

4



## Note:

When making up names for enumerators, it is not required that they be written in all uppercase letters. For example, we could have written the enumerators of the `Days` type as `monday, tuesday,` and so on. Because they represent constant values, however, many programmers prefer to write them in all uppercase letters. This is strictly a preference of style.

# Assigning an Integer to an `enum` Variable

Even though the enumerators of an enumerated data type are stored in memory as integers, you cannot directly assign an integer value to an `enum` variable. For example, assuming that `workDay` is a variable of the `Day` data type previously described, the following assignment statement is illegal:

```
workDay = 3; // Error!
```

Compiling this statement will produce an error message such as “Cannot convert `int` to `Day`.” When assigning a value to an `enum` variable, you should use a valid enumerator. However, if circumstances require that you store an integer value in an `enum` variable, you can do so by casting the integer. Here is an example:

```
workDay = static_cast<Day>(3);
```

This statement will produce the same results as:

```
workDay = THURSDAY;
```

# Assigning an Enumerator to an `int` Variable

Although you cannot directly assign an integer value to an `enum` variable, you can directly assign an enumerator to an integer variable. For example, the following code will work just fine.

```
enum Day { MONDAY, TUESDAY, WEDNESDAY, THURSDAY, FRIDAY };  
int x;  
x = THURSDAY;  
cout << x << endl;
```

When this code runs, it will display 3. You can also assign a variable of an enumerated type to an integer variable, as shown here:

```
Day workDay = FRIDAY;  
int x = workDay;  
cout << x << endl;
```

When this code runs, it will display 4.



# Comparing Enumerator Values

Enumerator values can be compared using the relational operators. For example, using the `Day` data type we have been discussing, the following expression is `true`:


```
FRIDAY > MONDAY
```

The expression is `true` because the enumerator `FRIDAY` is stored in memory as 4 and the enumerator `MONDAY` is stored as 0. The following code will display the message “Friday is greater than Monday.”:

```
if (FRIDAY > MONDAY)
    cout << "Friday is greater than Monday. \n";
```

You can also compare enumerator values with integer values. For example, the following code will display the message “Monday is equal to zero.”:

```
if (MONDAY == 0)
    cout << "Monday is equal to zero.\n";
```

Let's look at a complete program that uses much of what we have learned so far. **Program 11-9**  uses the `Day` data type we have been discussing.

## Program 11-9

```
1 // This program demonstrates an enumerated
data type.
2 #include <iostream>
3 #include <iomanip>
4 using namespace std;
5
6 enum Day { MONDAY, TUESDAY, WEDNESDAY,
THURSDAY, FRIDAY };
7
8 int main()
9 {
10     const int NUM_DAYS = 5;    // The number
of days
11     double sales[NUM_DAYS];    // To hold
sales for each day
12     double total = 0.0;        // Accumulator
13     int index;                 // Loop
counter
14
15     // Get the sales for each day.
16     for (index = MONDAY; index <= FRIDAY;
index++)
17     {
```

```
18         cout << "Enter the sales for day "
19         << index << ": ";
20         cin >> sales[index];
21     }
22
23     // Calculate the total sales.
24     for (index = MONDAY; index <= FRIDAY;
index++)
25         total += sales[index];
26
27     // Display the total.
28     cout << "The total sales are $" <<
setprecision(2)
29         << fixed << total << endl;
30
31     return 0;
32 }
```

**Program Output with Example Input Shown in Bold**

```
Enter the sales for day 0: 1525.00 Enter
Enter the sales for day 1: 1896.50 Enter
Enter the sales for day 2: 1975.63 Enter
Enter the sales for day 3: 1678.33 Enter
Enter the sales for day 4: 1498.52 Enter
The total sales are $8573.98
```

# Anonymous Enumerated Types

Notice [Program 11-9](#) does not define a variable of the `Day` data type. Instead, it uses the `Day` data type's enumerators in the `for` loops. The counter variable `index` is initialized to `MONDAY` (which is 0), and the loop iterates as long as `index` is less than or equal to `FRIDAY` (which is 4). When you do not need to define variables of an enumerated type, you can actually make the type anonymous. An *anonymous enumerated type* is simply one that does not have a name. For example, in [Program 11-9](#) we could have declared the enumerated type as:

```
enum { MONDAY, TUESDAY, WEDNESDAY, THURSDAY, FRIDAY };
```

This declaration still creates the enumerators. We just can't use the data type to define variables, because the type does not have a name.

# Using Math Operators to Change the Value of an `enum` Variable

Even though enumerators are really integers, and `enum` variables really hold integer values, you can run into problems when trying to perform math operations with them. For example, look at the following code:

```
Day day1, day2; // Defines two Day variables.  
day1 = TUESDAY; // Assign TUESDAY to day1.  
day2 = day1 + 1; // ERROR! This will not work!
```


The third statement causes a problem because the expression `day1 + 1` results in the integer value 2. The assignment operator then attempts to assign the integer value 2 to the `enum` variable `day2`. Because C++ cannot implicitly convert an `int` to a `Day`, an error occurs. You can fix this by using a cast to explicitly convert the result to `Day`, as shown here:

```
day2 = static_cast<Day>(day1 + 1); // This works.
```

# Using an `enum` Variable to Step through an Array's Elements

Because enumerators are stored in memory as integers, you can use them as array subscripts. For example, look at the following code:

```
enum Day { MONDAY, TUESDAY, WEDNESDAY, THURSDAY, FRIDAY };  
  
const int NUM_DAYS = 5;  
  
double sales[NUM_DAYS];  
  
sales[MONDAY] = 1525.0;    // Stores 1525.0 in sales[0].  
sales[TUESDAY] = 1896.5;  // Stores 1896.5 in sales[1].  
sales[WEDNESDAY] = 1975.63; // Stores 1975.63 in sales[2].  
sales[THURSDAY] = 1678.33; // Stores 1678.33 in sales[3].  
sales[FRIDAY] = 1498.52;  // Stores 1498.52 in sales[4].
```

This code stores values in all five elements of the `sales` array. Because enumerator values can be used as array subscripts, you can use an `enum` variable in a loop to step through the elements of an array. However, using an `enum` variable for this purpose is not as straight-forward as using an `int` variable. This is because you cannot use the `++` or `--` operators directly on an `enum` variable. To understand what I mean, first look at the following code taken from [Program 11-9](#) :



```
for (index = MONDAY; index <= FRIDAY; index++)  
{  
    cout << "Enter the sales for day "  
        << index << ": ";  
    cin >> sales[index];  
}
```

In this code, `index` is an `int` variable used to step through each element of the array. It is reasonable to expect that we could use a `Day` variable instead, as shown in the following code:

```
Day workDay; // Define a Day variable  
// ERROR!!! This code will NOT work.  
for (workDay = MONDAY; workDay <= FRIDAY; workDay++)  
{  
    cout << "Enter the sales for day "  
        << workDay << ": ";  
    cin >> sales[workDay];  
}
```

Notice the `for` loop's update expression uses the `++` operator to increment `workDay`. Although this works fine with an `int` variable, the `++` operator cannot be used with an `enum` variable. Instead, you

must convert `workDay++` to an equivalent expression that will work. The expression `workDay++` attempts to do the same thing as:



```
workDay = workDay + 1; // Good idea, but still won't work.
```

However, this still will not work. We have to use a cast to explicitly convert the expression `workDay + 1` to the `Day` data type, like this:

```
workDay = static_cast<Day>(workDay + 1);
```

This is the expression that we must use in the `for` loop instead of `workDay++`. The corrected `for` loop looks like this:

```
for (workDay = MONDAY; workDay <= FRIDAY;
     workDay = static_cast<Day>(workDay + 1))
{
    cout << "Enter the sales for day "
         << workDay << ": ";
    cin >> sales[workDay];
}
```

**Program 11-10**  is a version of **Program 11-9**  that is modified to use a `Day` variable to step through the elements of the `sales` array.

## Program 11-10

```
1 // This program demonstrates an enumerated
data type.
2 #include <iostream>
3 #include <iomanip>
4 using namespace std;
5
6 enum Day { MONDAY, TUESDAY, WEDNESDAY,
THURSDAY, FRIDAY };
7
8 int main()
9 {
10     const int NUM_DAYS = 5;    // The number
of days
11     double sales[NUM_DAYS];    // To hold
sales for each day
12     double total = 0.0;        // Accumulator
13     Day workDay;               // Loop
counter
14
15     // Get the sales for each day.
16     for (workDay = MONDAY; workDay <= FRIDAY;
17         workDay =
static_cast<Day>(workDay + 1))
```

```

18     {
19         cout << "Enter the sales for day "
20             << workDay << ": ";
21         cin >> sales[workDay];
22     }
23
24     // Calculate the total sales.
25     for (workDay = MONDAY; workDay <= FRIDAY;
26         workDay =
static_cast<Day>(workDay + 1))
27         total += sales[workDay];
28
29     // Display the total.
30     cout << "The total sales are $" <<
setprecision(2)
31         << fixed << total << endl;
32
33     return 0;
34 }

```

**Program Output with Example Input Shown in Bold**

```
Enter the sales for day 0: 1525.00 Enter
Enter the sales for day 1: 1896.50 Enter
Enter the sales for day 2: 1975.63 Enter
Enter the sales for day 3: 1678.33 Enter
Enter the sales for day 4: 1498.52 Enter
The total sales are $8573.98
```


# Using Enumerators to Output Values

As you have already seen, sending an enumerator to `cout` causes the enumerator's integer value to be displayed. For example, assuming we are using the `Day` type previously described, the following statement displays 0:

```
cout << MONDAY << endl;
```

If you wish to use the enumerator to display a string such as "Monday," you'll have to write code that produces the desired string. For example, in the following code, assume `workDay` is a `Day` variable that has been initialized to some value. The `switch` statement displays the name of a day, based upon the value of the variable.

```
switch (workDay)
{
    case MONDAY      : cout << "Monday";
                    break;
    case TUESDAY     : cout << "Tuesday";
                    break;
    case WEDNESDAY   : cout << "Wednesday";
                    break;
    case THURSDAY    : cout << "Thursday";
                    break;
    case FRIDAY      : cout << "Friday";
}
}
```

**Program 11-11**  shows this type of code used in a function. Instead of asking the user to enter the sales for day 0, day 1, and so forth, it displays the names of the days.

## Program 11-11

```
1 // This program demonstrates an enumerated
data type.
2 #include <iostream>
3 #include <iomanip>
4 using namespace std;
5
6 enum Day { MONDAY, TUESDAY, WEDNESDAY,
THURSDAY, FRIDAY };
7
8 // Function prototype
9 void displayDayName(Day);
10
11 int main()
12 {
13     const int NUM_DAYS = 5;    // The number
of days
14     double sales[NUM_DAYS];    // To hold
sales for each day
15     double total = 0.0;        // Accumulator
16     Day workDay;               // Loop counter
17
18     // Get the sales for each day.
19     for (workDay = MONDAY; workDay <= FRIDAY;
```



```

20         workDay =
static_cast<Day>(workDay + 1))
21     {
22         cout << "Enter the sales for day ";
23         displayDayName(workDay);
24         cout << ": ";
25         cin >> sales[workDay];
26     }
27
28     // Calculate the total sales.
29     for (workDay = MONDAY; workDay <= FRIDAY;
30         workDay =
static_cast<Day>(workDay + 1))
31         total += sales[workDay];
32
33     // Display the total.
34     cout << "The total sales are $" <<
setprecision(2)
35         << fixed << total << endl;
36
37     return 0;
38 }
39
40
//*****
*****
41 // Definition of the displayDayName function

```

```

*
42 // This function accepts an argument of the
Day type and *
43 // displays the corresponding name of the day.
*
44
//*****
*****
45
46 void displayDayName(Day d)
47 {
48     switch(d)
49     {
50         case MONDAY : cout << "Monday";
51                     break;
52         case TUESDAY : cout << "Tuesday";
53                     break;
54         case WEDNESDAY : cout << "Wednesday";
55                     break;
56         case THURSDAY : cout << "Thursday";
57                     break;
58         case FRIDAY : cout << "Friday";
59     }
60 }

```


**Program Output with Example Input Shown in Bold**

```
Enter the sales for Monday: 1525.00 Enter
Enter the sales for Tuesday: 1896.50 Enter
Enter the sales for Wednesday: 1975.63 Enter
Enter the sales for Thursday: 1678.33 Enter
Enter the sales for Friday: 1498.52 Enter
The total sales are $8573.98
```

# Specifying Integer Values for Enumerators

By default, the enumerators in an enumerated data type are assigned the integer values 0, 1, 2, and so forth. If this is not appropriate, you can specify the values to be assigned, as in the following example:

```
enum Water { FREEZING = 32, BOILING = 212 };
```

In this example, the `FREEZING` enumerator is assigned the integer value 32, and the `BOILING` enumerator is assigned the integer value 212. [Program 11-12](#)  demonstrates how this enumerated type might be used.

## Program 11-12

```
1 // This program demonstrates an enumerated
data type.
2 #include <iostream>
3 #include <iomanip>
4 using namespace std;
5
6 int main()
7 {
8     enum Water { FREEZING = 32, BOILING = 212
};
9     int waterTemp; // To hold the water
temperature
10
11     cout << "Enter the current water
temperature: ";
12     cin >> waterTemp;
13     if (waterTemp <= FREEZING)
14         cout << "The water is frozen.\n";
15     else if (waterTemp >= BOILING)
16         cout << "The water is boiling.\n";
17     else
18         cout << "The water is not frozen or
boiling.\n";
```

```
19
20     return 0;
21 }
```

### **Program Output with Example Input Shown in Bold**

```
Enter the current water temperature: 10
Enter
The water is frozen.
```

### **Program Output with Example Input Shown in Bold**

```
Enter the current water temperature: 300
Enter
The water is boiling.
```

### **Program Output with Example Input Shown in Bold**

```
Enter the current water temperature: 92
Enter
The water is not frozen or boiling.
```

If you leave out the value assignment for one or more of the enumerators, it will be assigned a default value. Here is an example:

```
enum Colors { RED, ORANGE, YELLOW = 9, GREEN, BLUE };
```

In this example, the enumerator `RED` will be assigned the value 0, `ORANGE` will be assigned the value 1, `YELLOW` will be assigned the value 9, `GREEN` will be assigned the value 10, and `BLUE` will be assigned the value 11.

# Enumerators Must Be Unique within the Same Scope

Enumerators are identifiers just like variable names, named constants, and function names. As with all identifiers, they must be unique within the same scope. For example, an error will result if both of the following enumerated types are declared within the same scope. In the following example, the reason is that `ROOSEVELT` is declared twice.

```
enum Presidents { MCKINLEY, ROOSEVELT, TAFT };  
enum VicePresidents { ROOSEVELT, FAIRBANKS, SHERMAN }; //  
Error!
```

The following declarations will also cause an error if they appear within the same scope.

```
enum Status { OFF, ON };  
const int OFF = 0; // Error!
```



# Declaring the Type and Defining the Variables in One Statement

The following code uses two lines to declare an enumerated data type and define a variable of the type:

```
enum Car { PORSCHE, FERRARI, JAGUAR };  
Car sportsCar;
```

C++ allows you to declare an enumerated data type and define one or more variables of the type in the same statement. The previous code could be combined into the following statement:

```
enum Car { PORSCHE, FERRARI, JAGUAR } sportsCar;
```

The following statement declares the `Car` data type and defines two variables: `myCar` and `yourCar`.

```
enum Car { PORSCHE, FERRARI, JAGUAR } myCar, yourCar;
```

# Using Strongly Typed `enums` in C++ 11

**11** Earlier, we mentioned that you cannot have multiple enumerators with the same name, within the same scope. In C++ 11, you can use a new type of `enum`, known as a *strongly typed enum* (also known as an *enum class*), to get around this limitation. Here are two examples of a strongly typed `enum` declaration:

```
enum class Presidents { MCKINLEY, ROOSEVELT, TAFT };  
enum class VicePresidents { ROOSEVELT, FAIRBANKS, SHERMAN };
```

These statements declare two strongly typed `enums`: `Presidents` and `VicePresidents`. Notice they look like regular `enum` declarations, except the word `class` appears after `enum`. Although both `enum`s contain the same enumerator (`ROOSEVELT`), these declarations will compile without an error.

When you use a strongly typed enumerator, you must prefix the enumerator with the name of the `enum`, followed by the `::` operator. Here are two examples:

```
Presidents prez = Presidents::ROOSEVELT;  
VicePresidents vp = VicePresidents::ROOSEVELT;
```

The first statement defines a `Presidents` variable named `prez`, and initializes it with the `Presidents::ROOSEVELT` enumerator. The second statement defines a `VicePresidents` variable named `vp`, and initializes it with the `VicePresidents::ROOSEVELT` enumerator. Here is an example of an `if` statement that compares the `prez` variable with an enumerator:

```
if (prez == Presidents::ROOSEVELT)  
    cout << "Roosevelt is president!\n";
```

Strongly typed enumerators are stored as integers like regular enumerators. However, if you want to retrieve a strongly typed enumerator's underlying integer value, you must use a cast operator. Here is an example:

```
int x = static_cast<int>(Presidents::ROOSEVELT);
```

This statement assigns the underlying integer value of the `Presidents::ROOSEVELT` enumerator to the variable `x`. Here is another example:

```
cout << static_cast<int>(Presidents::TAFT) << endl  
      << static_cast<int>(Presidents::MCKINLEY) << endl;
```

This statement displays the integer values for the `Presidents::TAFT` and the `Presidents::MCKINLEY` enumerators.

When you declare a strongly typed `enum`, you can optionally specify any integer data type as the underlying type. You simply write a colon (:) after the enum name, followed by the desired data type. For example, the following statement declares an `enum` that uses the `char` data type for its enumerators:

```
enum class Day : char { MONDAY, TUESDAY, WEDNESDAY, THURSDAY,  
FRIDAY };
```

The following statement shows another example. This statement declares an `enum` named `Water` that uses `unsigned` as the data type of its enumerators. Additionally, values are assigned to the enumerators.

```
enum class Water : unsigned { FREEZING = 32, BOILING = 212 };
```



# Checkpoint

11.16 Look at the following declaration:

```
enum Flower { ROSE, DAISY, PETUNIA };
```

In memory, what value will be stored for the enumerator `ROSE`? For `DAISY`? For `PETUNIA`?

11.17 What will the following code display?

```
enum { HOBBIT, ELF = 7, DRAGON };  
cout << HOBBIT << " " << ELF << " " << DRAGON << endl;
```

11.18 Does the enumerated data type declared in Checkpoint Question 11.17 have a name, or is it anonymous?

11.19 What will the following code display?

```
enum Letters { Z, Y, X };  
if (Z > X)  
    cout << "Z is greater than X. \n";  
else  
    cout << "Z is not greater than X. \n";
```

11.20 Will the following code cause an error, or will it compile without any errors? If it causes an error, rewrite it so it compiles.

```
enum Color { RED, GREEN, BLUE };  
  
Color c;  
  
c = 0;
```

11.21 Will the following code cause an error, or will it compile without any errors? If it causes an error, rewrite it so it compiles.

```
enum Color { RED, GREEN, BLUE };  
  
Color c = RED;  
  
c++;
```



### Note:

For an additional example of this chapter's topics, see the High Adventure Travel Part 2 Case Study on the Computer Science Portal at [pearsonhighered.com/gaddis](https://pearsonhighered.com/gaddis).

# Review Questions and Exercises

## Short Answer

1. What is a primitive data type?
2. Does a structure declaration cause a structure variable to be created?
3. Both arrays and structures are capable of storing multiple values. What is the difference between an array and a structure?
4. Look at the following structure declaration:

```
struct Point
{
    int x;
    int y;
};
```

Write statements that

- A. define a `Point` structure variable named `center`.
- B. assign 12 to the `x` member of `center`.
- C. assign 7 to the `y` member of `center`.

D. display the contents of the `x` and `y` members of `center`.

5. Look at the following structure declaration:

```
struct FullName
{
    string lastName;
    string middleName;
    string firstName;
};
```

Write statements that

- A. define a `FullName` structure variable named `info`.
- B. assign your last, middle, and first name to the members of the `info` variable.
- C. display the contents of the members of the `info` variable.

6. Look at the following code:

```
struct PartData
{
    string partName;
    int idNumber;
};

PartData inventory[100];
```



Write a statement that displays the contents of the `partName` member of element 49 of the `inventory` array.

7. Look at the following code:

```
struct Town
{
    string townName;
    string countyName;
    double population;
    double elevation;
};

Town t = { "Canton", "Haywood", 9478 };
```

- A. What value is stored in `t.townName`?
- B. What value is stored in `t.countyName`?
- C. What value is stored in `t.population`?
- D. What value is stored in `t.elevation`?

8. Look at the following code:

```
structure Rectangle
{
    int length;
    int width;
};

Rectangle *r = nullptr;
```

Write statements that

- A. dynamically allocate a `Rectangle` structure variable and use `r` to point to it.
- B. assign 10 to the structure's `length` member and 14 to the structure's `width` member.

9. What will the following code display?

```
enum { POODLE, BOXER, TERRIER };  
  
cout << POODLE << " " << BOXER << " " << TERRIER << endl;
```

10. Look at the following declaration:

```
enum Person { BILL, JOHN, CLAIRE, BOB };  
  
Person p;
```

Indicate whether each of the following statements or expressions is valid or invalid.

- A. `p = BOB;`
- B. `p++;`
- C. `BILL > BOB`
- D. `p = 0;`
- E. `int x = BILL;`
- F. `p = static_cast<Person>(3);`
- G. `cout << CLAIRE << endl;`

# Fill-in-the-Blank

11. Before a structure variable can be created, the structure must be \_\_\_\_\_.
12. The \_\_\_\_\_ is the name of the structure type.
13. The variables declared inside a structure declaration are called \_\_\_\_\_.
14. A(n) \_\_\_\_\_ is required after the closing brace of a structure declaration.
15. In the definition of a structure variable, the \_\_\_\_\_ is placed before the variable name, just like the data type of a regular variable is placed before its name.
16. The \_\_\_\_\_ operator allows you to access structure members.

# Algorithm Workbench

17. The structure `Car` is declared as follows:

```
struct Car
{
    string carMake;
    string carModel;
    int yearModel;
    double cost;
};
```

Write a definition statement that defines a `Car` structure variable initialized with the following data:

Make: Ford

Model: Mustang

Year Model: 1968

Cost: \$20,000

18. Define an array of 25 of the `Car` structure variables (the structure is declared in Question 17).
19. Define an array of 35 of the `Car` structure variables. Initialize the first three elements with the following data:
20. Write a loop that will step through the array you defined in Question 19, displaying the contents of each element.

21. Declare a structure named `TempScale`, with the following members:

```
fahrenheit: a double
centigrade: a double
```

Next, declare a structure named `Reading`, with the following members:

```
windSpeed: an int
humidity: a double
temperature: a TempScale structure variable
```

Next, define a `Reading` structure variable.

22. Write statements that will store the following data in the variable you defined in Problem 21:

Wind Speed: 37 mph

Humidity: 32%

Fahrenheit temperature: 32 degrees

Centigrade temperature: 0 degrees

23. Write a function called `showReading`. It should accept a `Reading` structure variable (see Problem 21) as its argument. The function should display the contents of the variable on the screen.

24. Write a function called `findReading`. It should use a `Reading` structure reference variable (see Problem 21) as its

parameter. The function should ask the user to enter values for each member of the structure.

25. Write a function called `getReading`, which returns a `Reading` structure (see Problem 21). The function should ask the user to enter values for each member of a `Reading` structure, then return the structure.

26. Write a function called `recordReading`. It should use a `Reading` structure pointer variable (see Problem 21) as its parameter. The function should ask the user to enter values for each member of the structure pointed to by the parameter.

27. Rewrite the following statement using the structure pointer operator:

```
(*rptr).windSpeed = 50;
```

28. Look at the following statement:

```
enum Color { RED, ORANGE, GREEN, BLUE };
```

A. What is the name of the data type declared by this statement?

B. What are the enumerators for this type?

C. Write a statement that defines a variable of this type and initializes it with a valid value.

29. A pet store sells dogs, cats, birds, and hamsters. Write a declaration for an anonymous enumerated data type that can represent the types of pets the store sells.

# True or False

31. T F A semicolon is required after the closing brace of a structure declaration.
32. T F A structure declaration does not define a variable.
33. T F The contents of a structure variable can be displayed by passing the structure variable to the `cout` object.
34. T F Structure variables may not be initialized.
35. T F In a structure variable's initialization list, you do not have to provide initializers for all the members.
36. T F You may skip members in a structure's initialization list.
37. T F The following expression refers to element 5 in the array `carInfo: carInfo.model[5]`
38. T F An array of structures may be initialized.
39. T F A structure variable may not be a member of another structure.
40. T F A structure member variable may be passed to a function as an argument.
41. T F An entire structure may not be passed to a function as an argument.
42. T F A function may return a structure.
43. T F When a function returns a structure, it is always necessary for the function to have a local structure variable to hold the member values that are to be returned.
44. T F The indirection operator has higher precedence than the dot operator.

45. T F The structure pointer operator does not automatically dereference the structure pointer on its left.



# Find the Errors

Each of the following declarations, programs, and program segments has errors. Locate as many as you can.

45. 

```
struct
{
    int x;
    float y;
};
```

46. 

```
struct Values
{
    string name;
    int age;
}
```

47.

```
struct TwoVals
{
    int a, b;
};

int main ()
{
    TwoVals.a = 10;
    TwoVals.b = 20;
    return 0;
}
```

48.

```
#include <iostream>
using namespace std;
struct ThreeVals
{
    int a, b, c;
};

int main()
{
    ThreeVals vals = {1, 2, 3};
    cout << vals << endl;
    return 0;
}
```

49.

```
#include <iostream>
#include <string>
using namespace std;
struct names
{
    string first;
    string last;
};
int main ()
{
    names customer = "Smith", "Orley";
    cout << names.first << endl;
    cout << names.last << endl;
    return 0;
}
```

50.

```
struct FourVals
{
    int a, b, c, d;
};
int main ()
{
    FourVals nums = {1, 2, , 4};
    return 0;
}
```

51.

```
struct TwoVals
{
    int a;
    int b;
};

TwoVals getVals()
{
    TwoVals.a = TwoVals.b = 0;
}
```

52.

```
struct ThreeVals
{
    int a, b, c;
};

int main ()
{
    TwoVals s, *sptr = nullptr;
    sptr = &s;
    *sptr.a = 1;
    return 0;
}
```

# Programming Challenges

## 1. Movie Data

Write a program that uses a structure named `MovieData` to store the following information about a movie:

Title

Director

Year Released

Running Time (in minutes)

The program should create two `MovieData` variables, store values in their members, and pass each one, in turn, to a function that displays the information about the movie in a clearly formatted manner.

## 2. Movie Profit

Modify the program written for Programming Challenge 1 (Movie Data) to include two additional members that hold the movie's production costs and first-year revenues. Modify the function that displays the movie data to display the title, director, release year, running time, and first year's profit or loss.

## 3. Corporate Sales Data

Write a program that uses a structure to store the following data on a company division:

Division Name (such as East, West, North, or South)

First-Quarter Sales

Second-Quarter Sales

Third-Quarter Sales

Fourth-Quarter Sales

Total Annual Sales

Average Quarterly Sales

The program should use four variables of this structure. Each variable should represent one of the following corporate divisions: East, West, North, and South. The user should be asked for the four quarters' sales figures for each division. Each division's total and average sales should be calculated and stored in the appropriate member of each structure variable. These figures should then be displayed on the screen.

*Input Validation: Do not accept negative numbers for any sales figures.*

#### **4. Weather Statistics**



## **Solving the Weather Statistics Problem**

Write a program that uses a structure to store the following weather data for a particular month:

Total Rainfall

High Temperature

Low Temperature

Average Temperature

The program should have an array of 12 structures to hold weather data for an entire year. When the program runs, it should ask the user to enter data for each month. (The average temperature should be calculated.) Once the data are entered for all the months, the program should calculate and display the average monthly rainfall, the total rainfall for the year, the highest and lowest temperatures for the year (and the months they occurred in), and the average of all the monthly average temperatures.

*Input Validation: Only accept temperatures within the range between  $-100$  and  $+140$  degrees Fahrenheit.*

## 5. Weather Statistics Modification

Modify the program that you wrote for Programming Challenge 4 (weather statistics) so it defines an enumerated data type with enumerators for the months ( `JANUARY` , `FEBRUARY` , so on). The program should use the enumerated type to step through the elements of the array.

## 6. Soccer Scores

Write a program that stores the following data about a soccer player in a structure:

Player's Name

Player's Number

Points Scored by Player

The program should keep an array of 12 of these structures. Each element is for a different player on a team. When the program runs, it should ask the user to enter the data for each player. It should then show a table that lists each player's number, name, and points scored. The program should also calculate and display the total points earned by the team. The number and name of the player who has earned the most points should also be displayed.

*Input Validation: Do not accept negative values for players' numbers or points scored.*

## 7. Customer Accounts

Write a program that uses a structure to store the following data about a customer account:

Name



Address

City, State, and ZIP

Telephone Number

Account Balance

Date of Last Payment

The program should use an array of at least 10 structures. It should let the user enter data into the array, change the contents of any element, and display all the data stored in the array. The program should have a menu-driven user interface.

*Input Validation: When the data for a new account is entered, be sure the user enters data for all the fields. No negative account balances should be entered.*

#### **8. Search Function for Customer Accounts Program**

Add a function to Programming Challenge 7 (Customer Accounts) that allows the user to search the structure array for a particular customer's account. It should accept part of the customer's name as an argument then search for an account with a name that matches it. All accounts that match should be displayed. If no account matches, a message saying so should be displayed.

#### **9. Speakers' Bureau**

Write a program that keeps track of a speakers' bureau. The program should use a structure to store the following data about a speaker:

Name

Telephone Number

Speaking Topic

Fee Required

The program should use an array of at least 10 structures. It should let the user enter data into the array, change the contents of any element, and display all the data stored in the array. The program should have a menu-driven user interface. *Input Validation: When the data for a new speaker is entered, be sure the user enters data for all the fields. No negative amounts should be entered for a speaker's fee.*

**10. Search Function for the Speakers' Bureau Program**

Add a function to Programming Challenge 9 (Speakers' Bureau) that allows the user to search for a speaker on a particular topic. It should accept a key word as an argument then search the array for a structure with that key word in the Speaking Topic field. All structures that match should be displayed. If no structure matches, a message saying so should be displayed.

**11. Monthly Budget**

A student has established the following monthly budget:  
Write a program that has a `MonthlyBudget` structure designed to hold each of these expense categories. The program should pass the structure to a function that asks the user to enter the amounts spent in each budget category during a month. The program should then pass the structure to a function that displays a report indicating the amount over

or under in each category, as well as the amount over or under for the entire monthly budget.

## 12. Course Grade

Write a program that uses a structure to store the following data:

The program should keep a list of test scores for a group of students. It should ask the user how many test scores there are to be and how many students there are. It should then dynamically allocate an array of structures. Each structure's `Tests` member should point to a dynamically allocated array that will hold the test scores.

After the arrays have been dynamically allocated, the program should ask for the ID number and all the test scores for each student. The average test score should be calculated and stored in the `average` member of each structure. The course grade should be computed on the basis of the following grading scale:

The course grade should then be stored in the `Grade` member of each structure. Once all this data is calculated, a table should be displayed on the screen listing each student's name, ID number, average test score, and course grade.

*Input Validation: Be sure all the data for each student is entered. Do not accept negative numbers for any test score.*

## 13. Drink Machine Simulator

Write a program that simulates a soft drink machine. The program should use a structure that stores the following data:

Drink Name

Drink Cost

## Number of Drinks in Machine

The program should create an array of five structures. The elements should be initialized with the following data: Each time the program runs, it should enter a loop that performs the following steps: A list of drinks is displayed on the screen. The user should be allowed to either quit the program or pick a drink. If the user selects a drink, he or she will next enter the amount of money that is to be inserted into the drink machine. The program should display the amount of change that would be returned, and subtract one from the number of that drink left in the machine. If the user selects a drink that has sold out, a message should be displayed. The loop then repeats. When the user chooses to quit the program, it should display the total amount of money the machine earned.

*Input Validation: When the user enters an amount of money, do not accept negative values or values greater than \$1.00.*

## 14. Inventory Bins

Write a program that simulates inventory bins in a warehouse. Each bin holds a number of the same type of parts. The program should use a structure that keeps the following data:  
Description of the part kept in the bin

Number of parts in the bin

The program should have an array of 10 bins, initialized with the following data:

The program should have the following functions:

When the program runs, it should repeat a loop that performs the following steps: The user should see a list of what each bin holds and how many parts are in each bin. The user can choose to either quit the program or select a bin. When a bin is selected, the user can either add parts to it or remove parts from it. The loop then repeats, showing the updated bin data on the screen.

*Input Validation: No bin can hold more than 30 parts, so don't let the user add more than a bin can hold. Also, don't accept negative values for the number of parts being added or removed.*

---

# Chapter 12 Advanced File Operations

---

## Topics

12.1 File Operations [📄](#)

12.2 File Output Formatting [📄](#)

12.3 Passing File Stream Objects to Functions [📄](#)

12.4 More Detailed Error Testing [📄](#)

12.5 Member Functions for Reading and Writing Files [📄](#)

12.6 Focus on Software Engineering: Working with Multiple Files [📄](#)

12.7 Binary Files [📄](#)

12.8 Creating Records with Structures [📄](#)

12.9 Random-Access Files [📄](#)

12.10 Opening a File for Both Input and Output [📄](#)

## 12.1 File Operations

### Concept:

A file is a collection of data that is usually stored on a computer's disk. Data can be saved to files and then later reused.

Almost all real-world programs use files to store and retrieve data. Here are a few examples of familiar software packages that use files extensively:

- **Word Processors:** Word processing programs are used to write letters, memos, reports, and other documents. The documents are then saved in files so they can be edited and reprinted.
- **Database Management Systems:** DBMSs are used to create and maintain databases. Databases are files that contain large collections of data, such as payroll records, inventories, sales statistics, and customer records.
- **Spreadsheets:** Spreadsheet programs are used to work with numerical data. Numbers and mathematical formulas can be inserted into the rows and columns of the spreadsheet. The spreadsheet can then be saved to a file for later use.
- **Compilers:** Compilers translate the source code of a program, which is saved in a file, into an executable file. Throughout the previous chapters of this book you have created many C++ source files and compiled them to executable files.

[Chapter 5](#) provided enough information for you to write programs that perform simple file operations. This chapter covers more advanced file operations and focuses primarily on the `fstream` data type. As a review, [Table 12-1](#) compares the `ifstream`, `ofstream`, and `fstream` data types. All of these data types require the `<fstream>` header file.

**Table 12-1 File Stream Data Types**

# Using the `fstream` Data Type

You define an `fstream` object just as you define objects of other data types. The following statement defines an `fstream` object named `dataFile`:

```
fstream dataFile;
```

As with `ifstream` and `ofstream` objects, you use an `fstream` object's `open` function to open a file. An `fstream` object's `open` function requires two arguments, however. The first argument is a string containing the name of the file. The second argument is a file access flag that indicates the mode in which you wish to open the file. Here is an example:

```
dataFile.open("info.txt", ios::out);
```

The first argument in this function call is the name of the file, `info.txt`. The second argument is the file access flag `ios::out`. This tells C++ to open the file in output mode. Output mode allows data to be written to a file. The following statement uses the `ios::in` access flag to open a file in input mode, which allows data to be read from the file.

```
dataFile.open("info.txt", ios::in);
```

There are many file access flags, as listed in [Table 12-2](#).

## Table 12-2 File Access Flags

Several flags may be used together if they are connected with the `|` operator. For example, assume `dataFile` is an `fstream` object in the following statement:

```
dataFile.open("info.txt", ios::in | ios::out);
```

This statement opens the file `info.txt` in both input and output modes. This means data may be written to and read from the file.




**Note:**

When used by itself, the `ios::out` flag causes the file's contents to be deleted if the file already exists. When used with the `ios::in` flag, however, the file's existing contents are preserved. If the file does not already exist, it will be created.

The following statement opens the file in such a way that data will only be written to its end:

```
dataFile.open("info.txt", ios::out | ios::app);
```

By using different combinations of access flags, you can open files in many possible modes.

**Program 12-1**  uses an `fstream` object to open a file for output, then writes data to the file.

## Program 12-1

```
1 // This program uses an fstream object to write data to a file.
2 #include <iostream>
3 #include <fstream>
4 using namespace std;
5
6 int main()
7 {
8     fstream dataFile;
9
10    cout << "Opening file...\n";
11    dataFile.open("demofile.txt", ios::out); // Open for output
12    cout << "Now writing data to the file.\n";
13    dataFile << "Jones\n"; // Write line 1
14    dataFile << "Smith\n"; // Write line 2
15    dataFile << "Willis\n"; // Write line 3
16    dataFile << "Davis\n"; // Write line 4
17    dataFile.close(); // Close the file
18    cout << "Done.\n";
19    return 0;
20 }
```

### Program Output

```
Opening file...
Now writing data to the file.
Done.
```

### Output to File demofile.txt

```
Jones
Smith
Willis
Davis
```

The file output is shown for [Program 12-1](#) the way it would appear if the file contents were displayed on the screen. The `\n` characters cause each name to appear on a separate line. The actual file contents, however, appear as a stream of characters as shown in [Figure 12-1](#).

**Figure 12-1 File contents**

J	o	n	e	s	\n	S	m	i	t	h	\n	W	i	l
l	i	s	\n	D	a	v	i	s	\n	<EOF>				

As you can see from the figure, `\n` characters are written to the file along with all the other characters. The characters are added to the file sequentially, in the order they are written by the program. The very last character is an *end-of-file marker*. It is a character that marks the end of the file, and is automatically written when the file is closed. (The actual character used to mark the end of a file depends upon the operating system being used. It is always a nonprinting character. For example, some systems use control-Z, which is ASCII code 26.)

[Program 12-2](#) is a modification of [Program 12-1](#) that further illustrates the sequential nature of files. The file is opened, two names are written to it, and it is closed. The file is then reopened by the program in append mode (with the `ios::app` access flag). When a file is opened in append mode, its contents are preserved, and all subsequent output is appended to the file's end. Two more names are added to the file before it is closed and the program terminates.

## Program 12-2

```
1 // This program writes data to a file, closes the file,
2 // then reopens the file and appends more data.
3 #include <iostream>
4 #include <fstream>
5 using namespace std;
6
7 int main()
8 {
9     ofstream dataFile;
10
11     cout << "Opening file...\n";
12     // Open the file in output mode.
13     dataFile.open("demofile.txt", ios::out);
14     cout << "Now writing data to the file.\n";
15     dataFile << "Jones\n"; // Write line 1
16     dataFile << "Smith\n"; // Write line 2
17     cout << "Now closing the file.\n";
18     dataFile.close(); // Close the file
19
20     cout << "Opening the file again...\n";
21     // Open the file in append mode.
22     dataFile.open("demofile.txt", ios::out | ios::app);
23     cout << "Writing more data to the file.\n";
24     dataFile << "Willis\n"; // Write line 3
25     dataFile << "Davis\n"; // Write line 4
26     cout << "Now closing the file.\n";
27     dataFile.close(); // Close the file
28
29     cout << "Done.\n";
30     return 0;
31 }
```

**Output to File demofile.txt**

```
Jones
Smith
Willis
Davis
```

The first time the file is opened, the names are written as shown in [Figure 12-2](#).

**Figure 12-2 Original file contents**

J	o	n	e	s	\n	S	m	i	t	h	\n	<EOF>
---	---	---	---	---	----	---	---	---	---	---	----	-------

The file is closed, and an end-of-file character is automatically written. When the file is reopened, the new output is appended to the end of the file, as shown in [Figure 12-3](#).

**Figure 12-3 New data appended to the file**

J	o	n	e	s	\n	S	m	i	t	h	\n	W	i	l
l	i	s	\n	D	a	v	i	s	\n	<EOF>				



**Note:**

If the `ios::out` flag had been alone, without `ios::app` the second time the file was opened, the file's contents would have been deleted. If this had been the case, the names Jones and Smith would have been erased, and the file would only have contained the names Willis and Davis.

# File Open Modes with `ifstream` and `ofstream` Objects

The `ifstream` and `ofstream` data types each have a default mode in which they open files. This mode determines the operations that may be performed on the file and what happens if the file that is being opened already exists. [Table 12-3](#) describes each data type's default open mode.

## Table 12-3 Default Open Mode

You cannot change the fact that `ifstream` files may only be read from, and `ofstream` files may only be written to. You can, however, vary the way operations are carried out on these files by providing a file access flag as an optional second argument to the `open` function. The following code shows an example using an `ofstream` object:

```
ofstream outputFile;  
outputFile.open("values.txt", ios::out|ios::app);
```

The `ios::app` flag specifies that data written to the `values.txt` file should be appended to its existing contents.

# Checking for a File's Existence Before Opening It

Sometimes you want to determine whether a file already exists before opening it for output. You can do this by first attempting to open the file for input. If the file does not exist, the open operation will fail. In that case, you can create the file by opening it for output. The following code gives an example:

```
fstream dataFile;
dataFile.open("values.txt", ios::in);
if (dataFile.fail())
{
    // The file does not exist, so create it.
    dataFile.open("values.txt", ios::out);
    //
    // Continue to process the file...
    //
}
else // The file already exists.
{
    dataFile.close();
    cout << "The file values.txt already exists.\n";
}
```

# Opening a File with the File Stream Object Definition Statement

An alternative to using the `open` member function is to use the file stream object definition statement to open the file. Here is an example:

```
fstream dataFile("names.txt", ios::in | ios::out);
```

This statement defines an `fstream` object named `dataFile` and uses it to open the file `names.txt`. The file is opened in both input and output modes. This technique eliminates the need to call the `open` function when your program knows the name and access mode of the file at the time the object is defined. You may also use this technique with `ifstream` and `ofstream` objects, as shown in the following examples.

```
ifstream inputFile("info.txt");  
ofstream outputFile("addresses.txt");  
ofstream dataFile("customers.txt", ios::out | ios::app);
```

You may also test for errors after you have opened a file with this technique. The following code shows an example:

```
ifstream inputFile("SalesData.txt");  
if (!inputFile)  
    cout << "Error opening SalesData.txt.\n";
```



## Checkpoint

12.1 Which file access flag would you use if you want all output to be written to the end of an existing file?

12.2 How do you use more than one file access flag?

12.3 Assuming `diskInfo` is an `fstream` object, write a statement that opens the file `names.dat` for output.

12.4 Assuming `diskInfo` is an `fstream` object, write a statement that opens the file `customers.txt` for output, where all output will be written to the end of the file.

12.5 Assuming `diskInfo` is an `fstream` object, write a statement that opens the file `payable.txt` for both input and output.

12.6 Write a statement that defines an `fstream` object named `dataFile` and opens a file named `salesfigures.txt` for input. (*Note:* The file should be opened with the definition statement, not an `open` function call.)

## 12.2 File Output Formatting

### Concept:

File output may be formatted in the same way that screen output is formatted.

The same output formatting techniques that are used with `cout`, which are covered in [Chapter 3](#), may also be used with file stream objects. For example, the `setprecision` and `fixed` manipulators may be called to establish the number of digits of precision to which floating-point values are rounded. [Program 12-3](#) demonstrates this.

## Program 12-3

```
1 // This program uses the setprecision and fixed
2 // manipulators to format file output.
3 #include <iostream>
4 #include <iomanip>
5 #include <fstream>
6 using namespace std;
7
8 int main()
9 {
10     fstream dataFile;
11     double num = 17.816392;
12
13     dataFile.open("numfile.txt", ios::out); // Open in output mode
14
15     dataFile << fixed; // Format for fixed-point notation
16     dataFile << num << endl; // Write the number
17
18     dataFile << setprecision(4); // Format for 4 decimal places
19     dataFile << num << endl; // Write the number
20
21     dataFile << setprecision(3); // Format for 3 decimal places
22     dataFile << num << endl; // Write the number
23
24     dataFile << setprecision(2); // Format for 2 decimal places
25     dataFile << num << endl; // Write the number
26
27     dataFile << setprecision(1); // Format for 1 decimal place
28     dataFile << num << endl; // Write the number
29
30     cout << "Done.\n";
31     dataFile.close(); // Close the file
32     return 0;
33 }
```

**Contents of File numfile.txt**

```
17.816392
```

```
17.8164
```

```
17.816
```

```
17.82
```

```
17.8
```

Notice the file output is formatted just as `cout` would format screen output. [Program 12-4](#) shows the `setw` stream manipulator being used to format file output into columns.

## Program 12-4

```
1 // This program writes three rows of numbers to a file.
2 #include <iostream>
3 #include <fstream>
4 #include <iomanip>
5 using namespace std;
6
7 int main()
8 {
9     const int ROWS = 3;    // Rows to write
10    const int COLS = 3;    // Columns to write
11    int nums[ROWS][COLS] = { 2897, 5, 837,
12                            34, 7, 1623,
13                            390, 3456, 12 };
14    fstream outFile("table.txt", ios::out);
15
16    // Write the three rows of numbers with each
17    // number in a field of 8 character spaces.
18    for (int row = 0; row < ROWS; row++)
19    {
20        for (int col = 0; col < COLS; col++)
21        {
22            outFile << setw(8) << nums[row][col];
23        }
24        outFile << endl;
25    }
26    outFile.close();
27    cout << "Done.\n";
28    return 0;
29 }
```

### Contents of File table.txt



## 12.3 Passing File Stream Objects to Functions

### Concept:


File stream objects may be passed by reference to functions.

When writing actual programs, you'll want to create modularized code for handling file operations. File stream objects may be passed to functions, but they should always be passed by reference. The `openFile` function shown below uses an `fstream` reference object parameter:



**Passing File Stream Objects to Functions**

```
bool openFileIn(fstream &file, string name)
{
    bool status;
    file.open(name, ios::in);
    if (file.fail())
        status = false;
    else
        status = true;
    return status;
}
```

The internal state of file stream objects changes with most every operation. They should always be passed to functions by reference to ensure internal consistency. [Program 12-5](#)  shows an example of how file stream objects may be passed as arguments to functions.



## Program 12-5

```
1 // This program demonstrates how file stream
objects may
2 // be passed by reference to functions.
3 #include <iostream>
4 #include <fstream>
5 #include <string>
6 using namespace std;
7
8 // Function prototypes
9 bool openFileIn(fstream &, string);
10 void showContents(fstream &);
11
12 int main()
13 {
14     fstream dataFile;
15
16     if (openFileIn(dataFile, "demofile.txt"))
17     {
18         cout << "File opened successfully.\n";
19         cout << "Now reading data from the
file.\n\n";
20         showContents(dataFile);
21         dataFile.close();
```

```
22         cout << "\nDone.\n";
23     }
24     else
25         cout << "File open error!" << endl;
26
27     return 0;
28 }
29
30
31 //*****
32 // Definition of function openFileIn. Accepts
33 // a reference *
34 // to an fstream object as an argument. The
35 // file is opened *
36 // for input. The function returns true upon
37 // success, false *
38 // upon failure.
39 *
40
41 //*****
42
43 bool openFileIn(fstream &file, string name)
44 {
45     file.open(name, ios::in);
46     if (file.fail())
```

```
41         return false;
42     else
43         return true;
44 }
45
46
47 //*****
48 // Definition of function showContents.
49 // Accepts an fstream *
50 // reference as its argument. Uses a loop to
51 // read each name *
52 // from the file and displays it on the
53 // screen. *
54
55 //*****
56
57 void showContents(fstream &file)
58 {
59     string line;
60
61     while (file >> line)
62     {
63         cout << line << endl;
64     }
65 }
```

## Program Output

```
File opened successfully.  
Now reading data from the file.
```

```
Jones
```

```
Smith
```

```
Willis
```

```
Davis
```

```
Done.
```

## 12.4 More Detailed Error Testing

### Concept:

All stream objects have error state bits that indicate the condition of the stream.


All stream objects contain a set of bits that act as flags. These flags indicate the current state of the stream. [Table 12-4](#) lists these bits. These bits can be tested by the member functions listed in [Table 12-5](#). (You've already learned about the `fail()` function.) One of the functions listed in the table, `clear()`, can be used to set a status bit.

### Table 12-4 Stream Bits

### Table 12-5 Functions to Test the State of Stream Bits

The function `showState`, shown here, accepts a file stream reference as its argument. It shows the state of the file by displaying the return values of the `eof()`, `fail()`, `bad()`, and `good()` member functions.

```
void showState(fstream &file)
{
    cout << "File Status:\n";
    cout << " eof bit: " << file.eof() << endl;
    cout << " fail bit: " << file.fail() << endl;
    cout << " bad bit: " << file.bad() << endl;
    cout << " good bit: " << file.good() << endl;
    file.clear();      // Clear any bad bits
}
```

**Program 12-6**  uses the `showState` function to display `testFile`'s status after various operations. First, the file is created and the integer value 10 is stored in it. The file is then closed and reopened for input. The integer is read from the file, then a second read operation is performed. Because there is only one item in the file, the second read operation will result in an error.

## Program 12-6

```
1 // This program demonstrates the return value
of the stream
2 // object error testing member functions.
3 #include <iostream>
4 #include <fstream>
5 using namespace std;
6
7 // Function prototype
8 void showState(fstream &);
9
10 int main()
11 {
12     int num = 10;
13
14     // Open the file for output.
15     fstream testFile("stuff.dat", ios::out);
16     if (testFile.fail())
17     {
18         cout << "ERROR: Cannot open the
file.\n";
19         return 0;
20     }
21
```

```
22     // Write a value to the file.
23     cout << "Writing the value " << num << "
to the file.\n";
24     testFile << num;
25
26     // Show the bit states.
27     showState(testFile);
28
29     // Close the file.
30     testFile.close();
31
32     // Reopen the file for input.
33     testFile.open("stuff.dat", ios::in);
34     if (testFile.fail())
35     {
36         cout << "ERROR: Cannot open the
file.\n";
37         return 0;
38     }
39
40     // Read the only value from the file.
41     cout << "Reading from the file.\n";
42     testFile >> num;
43     cout << "The value " << num << " was
read.\n";
44
45     // Show the bit states.
```



```

46     showState(testFile);
47
48     // No more data in the file, but force an
invalid read operation.
49     cout << "Forcing a bad read operation.\n";
50     testFile >> num;
51
52     // Show the bit states.
53     showState(testFile);
54
55     // Close the file.
56     testFile.close();
57     return 0;
58 }
59
60
//*****
*****
61 // Definition of function showState. This
function uses *
62 // an ifstream reference as its parameter. The
return values of *
63 // the eof(), fail(), bad(), and good() member
functions are *
64 // displayed. The clear() function is called
before the function *
65 // returns.

```

```
*
66
//*****
*****
67
68 void showState(fstream &file)
69 {
70     cout << "File Status:\n";
71     cout << " eof bit: " << file.eof() <<
endl;
72     cout << " fail bit: " << file.fail() <<
endl;
73     cout << " bad bit: " << file.bad() <<
endl;
74     cout << " good bit: " << file.good() <<
endl;
75     file.clear(); // Clear any bad bits
76 }
```

## Program Output

Writing the value 10 to the file.

File Status:

eof bit: 0

fail bit: 0

bad bit: 0

good bit: 1

Reading from the file.

The value 10 was read.

File Status:

eof bit: 1

fail bit: 0

bad bit: 0

good bit: 1

Forcing a bad read operation.

File Status:

eof bit: 1

fail bit: 1

bad bit: 0

good bit: 0

## 12.5 Member Functions for Reading and Writing Files

### Concept:

File stream objects have member functions for more specialized file reading and writing.

If whitespace characters are part of the data in a file, a problem arises when the file is read by the `>>` operator. Because the operator considers whitespace characters as delimiters, it does not read them. For example, consider the file `murphy.txt`, which contains the following data:

- Jayne Murphy
- 47 Jones Circle
- Almond, NC 28702

**Figure 12-5** shows the way the data is recorded in the file.

**Figure 12-5 File contents**

J	a	y	n	e		M	u	r	p	h	y	\n	4	7
	J	o	n	e	s		C	i	r	c	l	e	\n	A
l	m	o	n	d	,		N	C			2	8	7	0
2	\n	<EOF>												

The problem that arises from the use of the `>>` operator is evident in the output of **Program 12-7**.

## Program 12-7

```
1 // This program demonstrates how the >> operator should not
2 // be used to read data that contain whitespace characters
3 // from a file.
4 #include <iostream>
5 #include <fstream>
6 #include <string>
7 using namespace std;
8
9 int main()
10 {
11     string input; // To hold file input
12     fstream nameFile; // File stream object
13
14     // Open the file in input mode.
15     nameFile.open("murphy.txt", ios::in);
16
17     // If the file was successfully opened, continue.
18     if (nameFile)
19     {
20         // Read the file contents.
21         while (nameFile >> input)
22         {
23             cout << input;
24         }
25
26         // Close the file.
27         nameFile.close();
28     }
29     else
30     {
31         cout << "ERROR: Cannot open file.\n";
32     }
33     return 0;
34 }
```

## Program Output

JayneMurphy47JonesCircleAlmond,NC28702

# The `getline` Function

The problem with [Program 12-7](#) can be solved by using the `getline` function. The function reads a “line” of data, including whitespace characters. Here is an example of the function call:

```
getline(dataFile, str, '\n');
```

The three arguments in this statement are explained as follows:

The statement is an instruction to read a line of characters from the file. The function will read until it encounters a `\n`. The line of characters will be stored in the `str` object.

[Program 12-8](#) is a modification of [Program 12-7](#). It uses the `getline` function to read whole lines of data from the file.

## Program 12-8

```
1 // This program uses the getline function to read a line of
2 // data from the file.
3 #include <iostream>
4 #include <fstream>
5 #include <string>
6 using namespace std;
7
8 int main()
9 {
10     string input; // To hold file input
11     fstream nameFile; // File stream object
12
13     // Open the file in input mode.
14     nameFile.open("murphy.txt", ios::in);
15
16     // If the file was successfully opened, continue.
17     if (nameFile)
18     {
19         // Read an item from the file.
20         getline(nameFile, input);
21
22         // While the last read operation
23         // was successful, continue.
24         while (nameFile)
25         {
26             // Display the last item read.
27             cout << input << endl;
28
29             // Read the next item.
30             getline(nameFile, input);
31         }
32
33         // Close the file.
34         nameFile.close();
35     }
36     else
37     {
```



```
38     cout << "ERROR: Cannot open file.\n";
39 }
40     return 0;
41 }
```

### Program Output

```
Jayne Murphy
47 Jones Circle
Almond, NC 28702
```

Because the third argument of the `getline` function was left out in [Program 12-8](#), its default value is `\n`. Sometimes you might want to specify another delimiter. For example, consider a file that contains multiple names and addresses, and that is internally formatted in the following manner:

### Contents of `names2.txt`

```
Jayne Murphy$47 Jones Circle$Almond, NC 28702\n$Bobbie Smith$
217 Halifax Drive$Canton, NC 28716\n$Bill Hammet$PO Box 121$
Springfield, NC 28357\n$
```

Think of this file as consisting of three records. A record is a complete set of data about a single item. Also, the records in the file above are made of three fields. The first field is the person's name. The second field is the person's street address or PO box number. The third field contains the person's city, state, and ZIP code. Notice each field ends with a `$` character, and each record ends with a `\n` character. [Program 12-9](#) demonstrates how a `getline` function can be used to detect the `$` characters.

## Program 12-9

```
1 // This file demonstrates the getline function with
2 // a specified delimiter.
3 #include <iostream>
4 #include <fstream>
5 #include <string>
6 using namespace std;
7
8 int main()
9 {
10     string input; // To hold file input
11
12     // Open the file for input.
13     fstream dataFile("names2.txt", ios::in);
14
15     // If the file was successfully opened, continue.
16     if (dataFile)
17     {
18         // Read an item using $ as a delimiter.
19         getline(dataFile, input, '$');
20
21         // While the last read operation
22         // was successful, continue.
23         while (dataFile)
24         {
25             // Display the last item read.
26             cout << input << endl;
27
28             // Read an item using $ as a delimiter.
29             getline(dataFile, input, '$');
30         }
31
32         // Close the file.
33         dataFile.close();
34     }
35     else
36     {
37         cout << "ERROR: Cannot open file.\n";
```

```
38     }  
39     return 0;  
40 }
```

#### Program Output

```
Jayne Murphy  
47 Jones Circle  
Almond, NC 28702  
  
Bobbie Smith  
217 Halifax Drive  
Canton, NC 28716  
  
Bill Hammet  
PO Box 121  
Springfield, NC 28357
```

Notice the `\n` characters, which mark the end of each record, are also part of the output. They cause an extra blank line to be printed on the screen, separating the records.



#### Note:

When using a printable character, such as `$`, to delimit data in a file, be sure to select a character that will not actually appear in the data itself. Since it's doubtful that anyone's name or address contains a `$` character, it's an acceptable delimiter. If the file contained dollar amounts, however, another delimiter would have been chosen.

## The `get` Member Function

The file stream object's `get` member function is also useful. It reads a single character from the file. Here is an example of its usage:


```
inFile.get(ch);
```

In this example, `ch` is a `char` variable. A character will be read from the file and stored in `ch`. **Program 12-10** [📄](#) shows the function used in a complete program. The user is asked for the name of a file. The file is opened and the `get` function is used in a loop to read the file's contents, one character at a time.

## Program 12-10

```
1 // This program asks the user for a file name. The file is
2 // opened and its contents are displayed on the screen.
3 #include <iostream>
4 #include <fstream>
5 #include <string>
6 using namespace std;
7
8 int main()
9 {
10     string fileName; // To hold the file name
11     char ch;         // To hold a character
12     fstream file;   // File stream object
13
14     // Get the file name
15     cout << "Enter a file name: ";
16     cin >> fileName;
17
18     // Open the file.
19     file.open(fileName, ios::in);
20
21     // If the file was successfully opened, continue.
22     if (file)
23     {
24         // Get a character from the file.
25         file.get(ch);
26
27         // While the last read operation was
28         // successful, continue.
29         while (file)
30         {
31             // Display the last character read.
32             cout << ch;
33
34             // Read the next character
35             file.get(ch);
36         }
37
```


```
38     // Close the file.
39     file.close();
40 }
41 else
42     cout << fileName << " could not be opened.\n";
43     return 0;
44 }
```

**Program 12-10**  will display the contents of any file. The `get` function even reads whitespaces, so all the characters will be shown exactly as they appear in the file.

## The `put` Member Function

The `put` member function writes a single character to the file. Here is an example of its usage:

```
outFile.put(ch);
```

In this statement, the variable `ch` is assumed to be a `char` variable. Its contents will be written to the file associated with the file stream object `outFile`. [Program 12-11](#)  demonstrates the `put` function.

## Program 12-11

```
1 // This program demonstrates the put member function.
2 #include <iostream>
3 #include <fstream>
4 using namespace std;
5
6 int main()
7 {
8     char ch; // To hold a character
9
10    // Open the file for output.
11    fstream dataFile("sentence.txt", ios::out);
12
13    cout << "Type a sentence and be sure to end it with a ";
14    cout << "period.\n";
15
16    // Get a sentence from the user one character at a time
17    // and write each character to the file.
18    cin.get(ch);
19    while (ch != '.')
20    {
21        dataFile.put(ch);
22        cin.get(ch);
23    }
24    dataFile.put(ch); // Write the period.
25
26    // Close the file.
27    dataFile.close();
28    return 0;
29 }
```

**Program Output with Example Input Shown in Bold**



Type a sentence and be sure to end it with a period.

**I am on my way to becoming a great programmer.** Enter

**Resulting Contents of the File** sentence.txt:

I am on my way to becoming a great programmer.



12.7 Assume the file input.txt contains the following characters:

R	u	n		S	p	o	t		r	u	n	\n	S	e
e		S	p	o	t		r	u	n	\n	<EOF>			

What will the following program display on the screen?

```
#include <iostream>
#include <fstream>
#include <string>
using namespace std;

int main()
{
    fstream inFile("input.txt", ios::in);
    string item;
    inFile >> item;
    while (inFile)
    {
        cout << item << endl;
        inFile >> item;
    }
    inFile.close();
    return 0;
}
```

12.8 Describe the difference between reading a file with the `>>` operator and the `getline` function.

12.9 What will be stored in the file out.txt after the following program runs?

```
#include <iostream>
#include <fstream>
#include <iomanip>
using namespace std;
int main()
{
    const int SIZE = 5;
    ofstream outFile("out.txt");
    double nums[SIZE] = {100.279, 1.719, 8.602, 7.777, 5.099};
    outFile << fixed << setprecision(2);
    for (int count = 0; count < 5; count++)
    {
        outFile << setw(8) << nums[count];
    }
    outFile.close();
    return 0;
}
```

# 12.6 Focus on Software Engineering: Working with Multiple Files

## **Concept:**

It's possible to have more than one file open at once in a program.



## **Working with Multiple Files**

Quite often you will need to have multiple files open at once. In many real-world applications, data about a single item are categorized and

written to several different files. For example, a payroll system might keep the following files:

When the system is writing paychecks, you can see that it will need to open each of the files listed above and read data from them. (Notice each file contains the employee number. This is how the program can locate a specific employee's data.)

In C++, you open multiple files by defining multiple file stream objects. For example, if you need to read from three files, you can define three file stream objects, such as:

```
ifstream file1, file2, file3;
```

Sometimes you will need to open one file for input and another file for output. For example, [Program 12-12](#) asks the user for a file name. The file is opened and read. Each character is converted to uppercase and written to a second file called out.txt. This type of program can be considered a *filter*. Filters read the input of one file, changing the data in some fashion, and write it out to a second file. The second file is a modified version of the first file.

## Program 12-12

```
1 // This program demonstrates reading from one
file and writing
2 // to a second file.
3 #include <iostream>
4 #include <fstream>
5 #include <string>
6 #include <cctype> // Needed for the toupper
function.
7 using namespace std;
8
9 int main()
10 {
11     string fileName; // To hold the file
name
12     char ch; // To hold a character
13     ifstream inFile; // Input file
14
15     // Open a file for output.
16     ofstream outFile("out.txt");
17
18     // Get the input file name.
19     cout << "Enter a file name: ";
20     cin >> fileName;
```

```
21
22     // Open the file for input.
23     inFile.open(filename);
24
25     // If the input file opened successfully,
continue.
26     if (inFile)
27     {
28         // Read a char from file 1.
29         inFile.get(ch);
30
31         // While the last read operation was
32         // successful, continue.
33         while (inFile)
34         {
35             // Write uppercase char to file 2.
36             outFile.put(toupper(ch));
37
38             // Read another char from file 1.
39             inFile.get(ch);
40         }
41
42         // Close the two files.
43         inFile.close();
44         outFile.close();
45         cout << "File conversion done.\n";
46     }
```

```
47     else
48         cout << "Cannot open " << fileName <<
endl;
49     return 0;
50 }
```

## Program Output with Example Input Shown in Bold

```
Enter a file name: hownow.txt Enter
File conversion done.
```

### **Contents of hownow.txt**

```
how now brown cow.
How Now?
```

### **Resulting Contents of out.txt**

```
HOW NOW BROWN COW.
HOW NOW?
```



## 12.7 Binary Files

### Concept:

Binary files contain data that is not necessarily stored as ASCII text.

All the files you've been working with so far have been text files. That means the data stored in the files has been formatted as ASCII text. Even a number, when stored in a file with the `<<` operator, is converted to text. For example, consider the following program segment:

```
ofstream file("num.dat");
short x = 1297;
file << x;
```

The last statement writes the contents of `x` to the file. When the number is written, however, it is stored as the characters `'1'`, `'2'`, `'9'`, and `'7'`. This is illustrated in [Figure 12-6](#).

**Figure 12-6 File contents**

'1'	'2'	'9'	'7'	<EOF>
-----	-----	-----	-----	-------

1297 expressed in ASCII

49	50	57	55	<EOF>
----	----	----	----	-------

The number 1297 isn't stored in memory (in the variable `x`) in the fashion depicted in the figure above, however. It is formatted as a binary number, occupying 2 bytes on a typical system. [Figure 12-7](#) shows how the number is represented in memory, using binary or hexadecimal.

**Figure 12-7 The value 1297 stored as a `short int`**

1297 as a short integer, in binary

00000101	00010001
----------	----------

1297 as a short integer, in hexadecimal

05	11
----	----

The representation of the number shown in [Figure 12-7](#) is the way the “raw” data is stored in memory. Data can be stored in a file in its pure, binary format. The first step is to open the file in binary mode. This is accomplished by using the `ios::binary` flag. Here is an example:

```
file.open("stuff.dat", ios::out | ios::binary);
```

Notice the `ios::out` and `ios::binary` flags are joined in the statement with the `|` operator. This causes the file to be opened in both output and binary modes.



**Note:**

By default, files are opened in text mode.

# The `write` and `read` Member Functions

The file stream object's `write` member function is used to write binary data to a file. The general format of the `write` member function is

```
fileObject.write(address, size);
```

Let's look at the parts of this function call format:

- `fileObject` is the name of a file stream object.
- `address` is the starting address of the section of memory that is to be written to the file. This argument is expected to be the address of a `char` (or a pointer to a `char`).
- `size` is the number of bytes of memory to write. This argument must be an integer value.

For example, the following code uses a file stream object named `file` to write a character to a binary file:

```
char letter = 'A';  
file.write(&letter, sizeof(letter));
```

The first argument passed to the `write` function is the address of the `letter` variable. This tells the `write` function where the data that is to be written to the file is located. The second argument is the size of the `letter` variable, which is returned from the `sizeof` operator. This tells the `write` function the number of bytes of data to write to the file. Because the sizes of data types can vary among systems, it is best to use the `sizeof` operator to determine the number of bytes to write. After this function call executes, the contents of the `letter` variable will be written to the binary file associated with the `file` object.

The following code shows another example. This code writes an entire `char` array to a binary file.

```
char data[] = {'A', 'B', 'C', 'D'};  
file.write(data, sizeof(data));
```

In this code, the first argument is the name of the `data` array. By passing the name of the array, we are passing a pointer to the beginning of the array. Because `data` is an array of `char` values, the name of

the array is a pointer to a `char`. The second argument passes the name of the array to the `sizeof` operator. When the name of an array is passed to the `sizeof` operator, the operator returns the number of bytes allocated to the array. After this function call executes, the contents of the `data` array will be written to the binary file associated with the `file` object.

The `read` member function is used to read binary data from a file into memory. The general format of the `read` member function is

```
fileObject.read(address, size);
```

Here are the parts of this function call format:

- `fileObject` is the name of a file stream object.
- `address` is the starting address of the section of memory where the data being read from the file is to be stored. This is expected to be the address of a `char` (or a pointer to a `char`).
- `size` is the number of bytes of memory to read from the file. This argument must be an integer value.

For example, suppose we want to read a single character from a binary file and store that character in the `letter` variable. The following code uses a file stream object named `file` to do just that:

```
char letter;  
file.read(&letter, sizeof(letter));
```

The first argument passed to the `read` function is the address of the `letter` variable. This tells the `read` function where to store the value that is read from the file. The second argument is the size of the `letter` variable. This tells the `read` function the number of bytes to read from the file. After this function executes, the `letter` variable will contain a character that was read from the file.

The following code shows another example. This code reads enough data from a binary file to fill an entire `char` array.

```
char data[4];  
file.read(data, sizeof(data));
```

In this code, the first argument is the address of the `data` array. The second argument is the number of bytes allocated to the array. On a system that uses 1-byte characters, this function will read 4 bytes from the file and store them in the `data` array.

**Program 12-13**  demonstrates writing a `char` array to a file then reading the data from the file back into memory.

## Program 12-13

```
1 // This program uses the write and read functions.
2 #include <iostream>
3 #include <fstream>
4 using namespace std;
5
6 int main()
7 {
8     const int SIZE = 4;
9     char data[SIZE] = {'A', 'B', 'C', 'D'};
10    fstream file;
11
12    // Open the file for output in binary mode.
13    file.open("test.dat", ios::out | ios::binary);
14
15    // Write the contents of the array to the file.
16    cout << "Writing the characters to the file.\n";
17    file.write(data, sizeof(data));
18
19    // Close the file.
20    file.close();
21
22    // Open the file for input in binary mode.
23    file.open("test.dat", ios::in | ios::binary);
24
25    // Read the contents of the file into the array.
26    cout << "Now reading the data back into memory.\n";
27    file.read(data, sizeof(data));
28
29    // Display the contents of the array.
30    for (int count = 0; count < SIZE; count++)
31        cout << data[count] << " ";
32    cout << endl;
33
34    // Close the file.
35    file.close();
```

```
36     return 0;  
37 }
```

### Program Output

```
Writing the characters to the file.  
Now reading the data back into memory.  
A B C D
```

# Writing Data other than `char` to Binary Files

Because the `write` and `read` member functions expect their first argument to be a pointer to a `char`, you must use a type cast when writing and reading items that are of other data types. To convert a pointer from one type to another, you should use the `reinterpret_cast` type cast. The general format of the type cast is

```
reinterpret_cast<dataType>(value)
```

where *dataType* is the data type that you are converting to, and *value* is the value that you are converting. For example, the following code uses the type cast to store the address of an `int` in a `char` pointer variable:

```
int x = 65;
char *ptr = nullptr;
ptr = reinterpret_cast<char *>(&x);
```

The following code shows how to use the type cast to pass the address of an integer as the first argument to the `write` member function:

```
int x = 27;
file.write(reinterpret_cast<char *>(&x), sizeof(x));
```

After the function executes, the contents of the variable `x` will be written to the binary file associated with the `file` object. The following code shows an `int` array being written to a binary file:

```
const int SIZE = 10;
int numbers[SIZE] = {1, 2, 3, 4, 5, 6, 7, 8, 9, 10};
file.write(reinterpret_cast<char *>(numbers), sizeof(numbers));
```

After this function call executes, the contents of the `numbers` array will be written to the binary file. The following code shows values being read from the file and stored into the `numbers` array:



```
const int SIZE = 10;
int numbers[SIZE];
file.read(reinterpret_cast<char *>(numbers), sizeof(numbers));
```

**Program 12-14**  demonstrates writing an `int` array to a file then reading the data from the file back into memory.

## Program 12-14

```
1 // This program uses the write and read functions.
2 #include <iostream>
3 #include <fstream>
4 using namespace std;
5
6 int main()
7 {
8     const int SIZE = 10;
9     fstream file;
10    int numbers[SIZE] = {1, 2, 3, 4, 5, 6, 7, 8, 9, 10};
11
12    // Open the file for output in binary mode.
13    file.open("numbers.dat", ios::out | ios::binary);
14
15    // Write the contents of the array to the file.
16    cout << "Writing the data to the file.\n";
17    file.write(reinterpret_cast<char *>(numbers), sizeof(numbers));
18
19    // Close the file.
20    file.close();
21
22    // Open the file for input in binary mode.
23    file.open("numbers.dat", ios::in | ios::binary);
24
25    // Read the contents of the file into the array.
26    cout << "Now reading the data back into memory.\n";
27    file.read(reinterpret_cast<char *>(numbers), sizeof(numbers));
28
29    // Display the contents of the array.
30    for (int count = 0; count < SIZE; count++)
31        cout << numbers[count] << " ";
32    cout << endl;
33
34    // Close the file.
35    file.close();
```

```
36     return 0;  
37 }
```

### Program Output

```
Writing the data to the file.  
Now reading the data back into memory.  
1 2 3 4 5 6 7 8 9 10
```

## 12.8 Creating Records with Structures

**Concept:**

Structures may be used to store fixed-length records to a file.

Earlier in this chapter, the concept of fields and records was introduced. A field is an individual piece of data pertaining to a single item. A record is made up of fields and is a complete set of data about a single item. For example, a set of fields might be a person's name, age, address, and phone number. Together, all those fields that pertain to one person make up a record.

In C++, structures provide a convenient way to organize data into fields and records. For example, the following code could be used to create a record containing data about a person:

```
const int NAME_SIZE = 51, ADDR_SIZE = 51, PHONE_SIZE = 14;
```


```
struct Info  
{  
    char name[NAME_SIZE];  
    int age;  
    char address1[ADDR_SIZE];  
    char address2[ADDR_SIZE];  
    char phone[PHONE_SIZE];  
};
```

Besides providing an organizational structure for data, structures also package data into a single unit. For example, assume the structure variable `person` is defined as

```
Info person;
```

Once the members (or fields) of `person` are filled with data, the entire variable may be written to a file using the `write` function:

```
file.write(reinterpret_cast<char *>(&person), sizeof(person));
```

The first argument is the address of the `person` variable. The `reinterpret_cast` operator is used to convert the address to a `char` pointer. The second argument is the `sizeof` operator with `person` as its `argument`. This returns the number of bytes used by the `person` structure. **Program 12-15**  demonstrates this technique.



### Note:

Because structures can contain a mixture of data types, you should always use the `ios::binary` mode when opening a file to store them.

## Program 12-15

```
1 // This program uses a structure variable to
store a record to a file.
2 #include <iostream>
3 #include <fstream>
4 using namespace std;
5
6 // Array sizes
7 const int NAME_SIZE = 51, ADDR_SIZE = 51,
PHONE_SIZE = 14;
8
9 // Declare a structure for the record.
10 struct Info
11 {
12     char name[NAME_SIZE];
13     int age;
14     char address1[ADDR_SIZE];
15     char address2[ADDR_SIZE];
16     char phone[PHONE_SIZE];
17 };
18
19 int main()
20 {
21     Info person; // To hold info about a
```

```
person
22     char again;    // To hold Y or N
23
24     // Open a file for binary output.
25     ofstream people("people.dat", ios::out |
ios::binary);
26
27     do
28     {
29         // Get data about a person.
30         cout << "Enter the following data
about a "
31             << "person:\n";
32         cout << "Name: ";
33         cin.getline(person.name, NAME_SIZE);
34         cout << "Age: ";
35         cin >> person.age;
36         cin.ignore(); // Skip over the
remaining newline.
37         cout << "Address line 1: ";
38         cin.getline(person.address1,
ADDR_SIZE);
39         cout << "Address line 2: ";
40         cin.getline(person.address2,
ADDR_SIZE);
41         cout << "Phone: ";
42         cin.getline(person.phone, PHONE_SIZE);
```



```
43
44         // Write the contents of the person
structure to the file.
45         people.write(reinterpret_cast<char *>
(&person),
46                 sizeof(person));
47
48         // Determine whether the user wants to
write another record.
49         cout << "Do you want to enter another
record? ";
50         cin >> again;
51         cin.ignore(); // Skip over the
remaining newline.
52     } while (again == 'Y' || again == 'y');
53
54     // Close the file.
55     people.close();
56     return 0;
57 }
```

**Program Output with Example Input Shown in Bold**

```
Enter the following data about a person:
```

```
Name: Charlie Baxter Enter
```

```
Age: 42 Enter
```

```
Address line 1: 67 Kennedy Blvd. Enter
```

```
Address line 2: Perth, SC 38754 Enter
```

```
Phone: (803)555-1234 Enter
```

```
Do you want to enter another record? Y
```

```
Enter
```

```
Enter the following data about a person:
```

```
Name: Merideth Murney Enter
```

```
Age: 22 Enter
```



```
Address line 1: 487 Lindsay Lane Enter
```

```
Address line 2: Hazelwood, NC 28737 Enter
```

```
Phone: (828)555-9999 Enter
```

```
Do you want to enter another record? N
```

```
Enter
```

**Program 12-15**  allows you to build a file by filling the members of the `person` variable, then writing the variable to the file. **Program 12-16**  opens the file and reads each record into the `person` variable, then displays the data on the screen.


## Program 12-16

```
1 // This program uses a structure variable to
read a record from a file.
2 #include <iostream>
3 #include <fstream>
4 using namespace std;
5
6 const int NAME_SIZE = 51, ADDR_SIZE = 51,
PHONE_SIZE = 14;
7
8 // Declare a structure for the record.
9 struct Info
10 {
11     char name[NAME_SIZE];
12     int age;
13     char address1[ADDR_SIZE];
14     char address2[ADDR_SIZE];
15     char phone[PHONE_SIZE];
16 };
17
18 int main()
19 {
20     Info person; // To hold info about a
person
```

```
21     char again;        // To hold Y or N
22     fstream people;   // File stream object
23
24     // Open the file for input in binary mode.
25     people.open("people.dat", ios::in |
ios::binary);
26
27     // Test for errors.
28     if (!people)
29     {
30         cout << "Error opening file. Program
aborting.\n";
31         return 0;
32     }
33
34
35     cout << "Here are the people in the
file:\n\n";
36     // Read the first record from the file.
37     people.read(reinterpret_cast<char *>
(&person),
38                 sizeof(person));
39
40     // While not at the end of the file,
display
41     // the records.
42     while (!people.eof())
```

```
43     {
44         // Display the record.
45         cout << "Name: ";
46         cout << person.name << endl;
47         cout << "Age: ";
48         cout << person.age << endl;
49         cout << "Address line 1: ";
50         cout << person.address1 << endl;
51         cout << "Address line 2: ";
52         cout << person.address2 << endl;
53         cout << "Phone: ";
54         cout << person.phone << endl;
55
56         // Wait for the user to press the
Enter key.
57         cout << "\nPress the Enter key to see
the next record.\n";
58         cin.get(again);
59
60         // Read the next record from the file.
61         people.read(reinterpret_cast<char *>
(&person),
62                     sizeof(person));
63     }
64
65     cout << "That's all the data in the
file!\n";
```

```
66     people.close();  
67     return 0;  
68 }
```

**Program Output (Using the same file created by  
Program 12-15  as input)**

Here are the people in the file:

Name: Charlie Baxter

Age: 42

Address line 1: 67 Kennedy Blvd.

Address line 2: Perth, SC 38754

Phone: (803)555-1234

Press the Enter key to see the next record.

Name: Merideth Murney

Age: 22

Address line 1: 487 Lindsay Lane

Address line 2: Hazelwood, NC 28737

Phone: (828)555-9999

Press the Enter key to see the next record.

That's all the data in the file!



## Note:

Structures containing pointers cannot be correctly stored to disk using the techniques of this section. This is because if the structure is read into memory on a subsequent run of the program, it cannot be guaranteed that all program variables will be at the same memory locations. Because `string` class objects contain implicit pointers, they cannot be a part of a structure that has to be stored.



## 12.9 Random-Access Files

### Concept:

Random access means nonsequentially accessing data in a file.

All of the programs created so far in this chapter have performed *sequential file access*. When a file is opened, the position where reading and/or writing will occur is at the file's beginning (unless the `ios::app` mode is used, which causes data to be written to the end of the file). If the file is opened for output, bytes are written to it one after the other. If the file is opened for input, data is read beginning at the first byte. As the reading or writing continues, the file stream object's read/write position advances sequentially through the file's contents.

The problem with sequential file access is that in order to read a specific byte from the file, all the bytes that precede it must be read first. For instance, if a program needs data stored at the hundredth byte of a file, it will have to read the first 99 bytes to reach it. If you've ever listened to a cassette tape player, you understand sequential access. To listen to a song at the end of the tape, you have to listen to all the songs that come before it, or fast-forward over them. There is no way to immediately jump to that particular song.

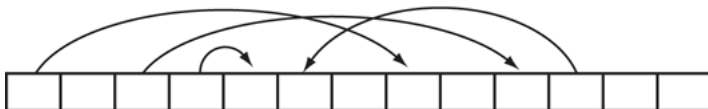
Although sequential file access is useful in many circumstances, it can slow a program down tremendously. If the file is very large, locating data buried deep inside it can take a long time. Alternatively, C++ allows a program to perform *random file access*. In random file access, a program may immediately jump to any byte in the file without first reading the preceding bytes. The difference between sequential and random file access is like the difference between a cassette tape and a compact disc. When listening to a CD, there is no need to listen to or fast forward over unwanted songs. You simply jump to the track that you want to listen to. This is illustrated in [Figure 12-8](#).

**Figure 12-8** Sequential versus random access

Sequential access



Random access



# The `seekp` and `seekg` Member Functions

File stream objects have two member functions that are used to move the read/write position to any byte in the file. They are `seekp` and `seekg`. The `seekp` function is used with files opened for output, and `seekg` is used with files opened for input. (It makes sense if you remember that “p” stands for “put” and “g” stands for “get.” `seekp` is used with files into which you put data, and `seekg` is used with files from which you get data out.)

Here is an example of `seekp`'s usage:

```
file.seekp(20L, ios::beg);
```

The first argument is a `long` integer representing an offset into the file. This is the number of the byte to which you wish to move. In this example, `20L` is used. (Remember, the L suffix forces the compiler to treat the number as a long integer.) This statement moves the file's write position to byte number 20. (All numbering starts at 0, so byte number 20 is actually the twenty-first byte.)

The second argument is called the mode, and it designates where to calculate the offset *from*. The flag `ios::beg` means the offset is calculated from the beginning of the file. Alternatively, the offset can be calculated from the end of the file or the current position in the file. [Table 12-6](#) lists the flags for all three of the random-access modes.

## Table 12-6 Offset Modes

[Table 12-7](#) shows examples of `seekp` and `seekg` using the various mode flags.

## Table 12-7 Mode Examples

Notice some of the examples in [Table 12-7](#) use a negative offset. Negative offsets result in the read or write position being moved backward in the file, while positive offsets result in a forward movement.

Assume the file `letters.txt` contains the following data:

```
abcdefghijklmnopqrstuvwxy
```




[Program 12-17](#) uses the `seekg` function to jump around to different locations in the file, retrieving a character after each stop.

## Program 12-17

```
1 // This program demonstrates the seekg function.
2 #include <iostream>
3 #include <fstream>
4 using namespace std;
5
6 int main()
7 {
8     char ch; // To hold a character
9
10    // Open the file for input.
11    fstream file("letters.txt", ios::in);
12
13    // Move to byte 5 from the beginning of the file
14    // (the 6th byte) and read the character there.
15    file.seekg(5L, ios::beg);
16    file.get(ch);
17    cout << "Byte 5 from beginning: " << ch << endl;
18
19    // Move to the 10th byte from the end of the file
20    // and read the character there.
21    file.seekg(-10L, ios::end);
22    file.get(ch);
23    cout << "10th byte from end: " << ch << endl;
24
25    // Move to byte 3 from the current position
26    // (the 4th byte) and read the character there.
27    file.seekg(3L, ios::cur);
28    file.get(ch);
29    cout << "Byte 3 from current: " << ch << endl;
30
31    file.close();
32    return 0;
33 }
```

## Program Screen Output

```
Byte 5 from beginning: f
10th byte from end: q
Byte 3 from current: u
```

**Program 12-18**  shows a more robust example of the `seekg` function. It opens the `people.dat` file created by **Program 12-15** . The file contains two records. **Program 12-18**  displays record 1 (the second record) first, then displays record 0.

The program has two important functions other than `main`. The first, `byteNum`, takes a record number as its argument and returns that record's starting byte. It calculates the record's starting byte by multiplying the record number by the size of the `Info` structure. This returns the offset of that record from the beginning of the file. The second function, `showRec`, accepts an `Info` structure as its argument and displays its contents on the screen.

## Program 12-18

```
1 // This program randomly reads a record of data from a file.
2 #include <iostream>
3 #include <fstream>
4 using namespace std;
5
6 const int NAME_SIZE = 51, ADDR_SIZE = 51, PHONE_SIZE = 14;
7
8 // Declare a structure for the record.
9 struct Info
10 {
11     char name[NAME_SIZE];
12     int age;
13     char address1[ADDR_SIZE];
14     char address2[ADDR_SIZE];
15     char phone[PHONE_SIZE];
16 };
17
18 // Function Prototypes
19 long byteNum(int);
20 void showRec(Info);
21
22 int main()
23 {
24     Info person; // To hold info about a person
25     fstream people; // File stream object
26
27     // Open the file for input in binary mode.
28     people.open("people.dat", ios::in | ios::binary);
29
30     // Test for errors.
31     if (!people)
32     {
33         cout << "Error opening file. Program aborting.\n";
34         return 0;
35     }
36
37     // Read and display record 1 (the second record).
```

```

38     cout << "Here is record 1:\n";
39     people.seekg(byteNum(1), ios::beg);
40     people.read(reinterpret_cast<char *>(&person), sizeof(person));
41     showRec(person);
42
43     // Read and display record 0 (the first record).
44     cout << "\nHere is record 0:\n";
45     people.seekg(byteNum(0), ios::beg);
46     people.read(reinterpret_cast<char *>(&person), sizeof(person));
47     showRec(person);
48
49     // Close the file.
50     people.close();
51     return 0;
52 }
53
54 //*****
55 // Definition of function byteNum. Accepts an integer as *
56 // its argument. Returns the byte number in the file of the *
57 // record whose number is passed as the argument. *
58 //*****
59
60 long byteNum(int recNum)
61 {
62     return sizeof(Info) * recNum;
63 }
64
65 //*****
66 // Definition of function showRec. Accepts an Info structure *
67 // as its argument, and displays the structure's contents. *
68 //*****
69
70 void showRec(Info record)
71 {
72     cout << "Name: ";
73     cout << record.name << endl;
74     cout << "Age: ";
75     cout << record.age << endl;
76     cout << "Address line 1: ";
77     cout << record.address1 << endl;
78     cout << "Address line 2: ";

```

```
79     cout << record.address2 << endl;
80     cout << "Phone: ";
81     cout << record.phone << endl;
82 }
```

### Program Output (Using the same file created by Program 12–15 as input)

```
Here is record 1:
Name: Merideth Murney
Age: 22
Address line 1: 487 Lindsay Lane
Address line 2: Hazelwood, NC 28737
Phone: (828)555-9999

Here is record 0:
Name: Charlie Baxter
Age: 42
Address line 1: 67 Kennedy Blvd.
Address line 2: Perth, SC 38754
Phone: (803)555-1234
```



### **Warning!**

If a program has read to the end of a file, you must call the file stream object's `clear` member function before calling `seekg` or `seekp`. This clears the file stream object's `eof` flag. Otherwise, the `seekg` or `seekp` function will not work.

## The `tellp` and `tellg` Member Functions

File stream objects have two more member functions that may be used for random file access: `tellp` and `tellg`. Their purpose is to return, as a long integer, the current byte number of a file's read and write position. As you can guess, `tellp` returns the write position and `tellg` returns the read position. Assuming `pos` is a long integer, here is an example of the functions' usage:

```
pos = outFile.tellp();
pos = inFile.tellg();
```

One application of these functions is to determine the number of bytes that a file contains. The following example demonstrates how to do this using the `tellg` function:

```
file.seekg(0L, ios::end);
numBytes = file.tellg();
cout << "The file has " << numBytes << " bytes.\n";
```

First, the `seekg` member function is used to move the read position to the last byte in the file. Then, the `tellg` function is used to get the current byte number of the read position.

**Program 12-19** [📄](#) demonstrates the `tellg` function. It opens the `letters.txt` file, which was also used in **Program 12-17** [📄](#). The file contains the following characters:

```
abcdefghijklmnopqrstuvwxy
```



## Program 12-19

```
1 // This program demonstrates the tellg function.
2 #include <iostream>
3 #include <fstream>
4 using namespace std;
5
6 int main()
7 {
8     long offset;    // To hold an offset amount
9     long numBytes; // To hold the file size
10    char ch;        // To hold a character
11    char again;    // To hold Y or N
12
13    // Open the file for input.
14    fstream file("letters.txt", ios::in);
15
16    // Determine the number of bytes in the file.
17    file.seekg(0L, ios::end);
18    numBytes = file.tellg();
19    cout << "The file has " << numBytes << " bytes.\n";
20
21    // Go back to the beginning of the file.
22    file.seekg(0L, ios::beg);
23
24    // Let the user move around within the file.
25    do
26    {
27        // Display the current read position.
28        cout << "Currently at position " << file.tellg() << endl;
29
30        // Get a byte number from the user.
31        cout << "Enter an offset from the beginning of the file: ";
32        cin >> offset;
33
34        // Move the read position to that byte, read the
35        // character there, and display it.
36        if (offset >= numBytes) // Past the end of the file?
37            cout << "Cannot read past the end of the file.\n";
```

```

38     else
39     {
40         file.seekg(offset, ios::beg);
41         file.get(ch);
42         cout << "Character read: " << ch << endl;
43     }
44
45     // Does the user want to try this again?
46     cout << "Do it again? ";
47     cin >> again;
48 } while (again == 'Y' || again == 'y');
49
50 // Close the file.
51 file.close();
52 return 0;
53 }

```

### Program Output with Example Input Shown in Bold

```

The file has 26 bytes.
Currently at position 0
Enter an offset from the beginning of the file: 5 Enter
Character read: f
Do it again? y Enter
Currently at position 6
Enter an offset from the beginning of the file: 0 Enter
Character read: a
Do it again? y Enter
Currently at position 1
Enter an offset from the beginning of the file: 26 Enter
Cannot read past the end of the file.
Do it again? n Enter

```

## Rewinding a Sequential-Access File with `seekg`

Sometimes when processing a sequential file, it is necessary for a program to read the contents of the file more than one time. For example, suppose a program searches a file for an item specified by the user. The program must open the file, read its contents, and determine if the specified item is in the file. If the user needs to search the file again for another item, the program must read the file's contents again.

One simple approach for reading a file's contents more than once is to close and reopen the file, as shown in the following code example:

```
dataFile.open("file.txt", ios::in); // Open the file.
//
// Read and process the file's contents.
//
dataFile.close(); // Close the file.
dataFile.open("file.txt", ios::in); // Open the file again.
//
// Read and process the file's contents again.
//
dataFile.close(); // Close the file.
```

Each time the file is reopened, its read position is located at the beginning of the file. The read position is the byte in the file that will be read with the next read operation.

Another approach is to “rewind” the file. This means moving the read position to the beginning of the file without closing and reopening it. This is accomplished with the file stream object's `seekg` member function to move the read position back to the beginning of the file. The following example code demonstrates this.

```
dataFile.open("file.txt", ios::in); // Open the file.
//
// Read and process the file's contents.
//
dataFile.clear(); // Clear the eof flag.
dataFile.seekg(0L, ios::beg); // Rewind the read position.
//
// Read and process the file's contents again.
//
dataFile.close(); // Close the file.
```

Notice prior to calling the `seekg` member function, the `clear` member function is called. As previously mentioned, this clears the file object's `eof` flag and is necessary only if the program has read to the end of the file. This approach eliminates the need to close and reopen the file each time the file's contents are processed.

# 12.10 Opening a File for Both Input and Output

## Concept:

You may perform input and output on an `fstream` file without closing it and reopening it.

Sometimes you'll need to perform both input and output on a file without closing and reopening it. For example, consider a program that allows you to search for a record in a file then make changes to it. A read operation is necessary to copy the data from the file to memory. After the desired changes have been made to the data in memory, a write operation is necessary to replace the old data in the file with the new data in memory.

Such operations are possible with `fstream` objects. The `ios::in` and `ios::out` file access flags may be joined with the `|` operator, as shown in the following statement:

```
fstream file("data.dat", ios::in | ios::out)
```

The same operation may be accomplished with the `open` member function.


```
file.open("data.dat", ios::in | ios::out);
```

You may also specify the `ios::binary` flag if binary data is to be written to the file. Here is an example:

```
file.open("data.dat", ios::in | ios::out | ios::binary);
```

When an `fstream` file is opened with both the `ios::in` and `ios::out` flags, the file's current contents are preserved, and the read/write position is initially placed at the beginning of the file. If the file does not exist, it is created.

**Programs 12-20** [📄](#), **12-21** [📄](#), and **12-22** [📄](#) demonstrate many of the techniques we have discussed. **Program 12-20** [📄](#) sets up a file with five blank inventory records. Each record is a structure with members for holding a part description, quantity on hand, and price. **Program 12-21** [📄](#) displays the contents of the file on the screen.

**Program 12-22**  opens the file in both input and output modes and allows the user to change the contents of a specific record.

## Program 12-20




```
1 // This program sets up a file of blank
inventory records.
2 #include <iostream>
3 #include <fstream>
4 using namespace std;
5
6 // Constants
7 const int DESC_SIZE = 31; // Description
size
8 const int NUM_RECORDS = 5; // Number of
records
9
10 // Declaration of InventoryItem structure
11 struct InventoryItem
12 {
13     char desc[DESC_SIZE];
14     int qty;
15     double price;
16 };
17
18 int main()
19 {
20     // Create an empty InventoryItem
```



```
structure.  
21     InventoryItem record = { "", 0, 0.0 };  
22  
23     // Open the file for binary output.  
24     fstream inventory("Inventory.dat",  
ios::out | ios::binary);  
25  
26     // Write the blank records  
27     for (int count = 0; count < NUM_RECORDS;  
count++)  
28     {  
29         cout << "Now writing record " << count  
<< endl;  
30         inventory.write(reinterpret_cast<char  
*>(&record),  
31                             sizeof(record));  
32     }  
33  
34     // Close the file.  
35     inventory.close();  
36     return 0;  
37 }
```

## Program Output

```
Now writing record 0  
Now writing record 1  
Now writing record 2  
Now writing record 3  
Now writing record 4
```

**Program 12-21**  simply displays the contents of the inventory file on the screen. It can be used to verify that **Program 12-20**  successfully created the blank records, and that **Program 12-22**  correctly modified the designated record.

## Program 12-21

```
1 // This program displays the contents of the
inventory file.
2 #include <iostream>
3 #include <fstream>
4 using namespace std;
5
6 const int DESC_SIZE = 31; // Description size
7
8 // Declaration of InventoryItem structure
9 struct InventoryItem
10 {
11     char desc[DESC_SIZE];
12     int qty;
13     double price;
14 };
15
16 int main()
17 {
18     InventoryItem record; // To hold an
inventory record
19
20     // Open the file for binary input.
21     fstream inventory("Inventory.dat", ios::in
```

```
| ios::binary);  
22  
23     // Now read and display the records  
24     inventory.read(reinterpret_cast<char *>  
    (&record),  
25                     sizeof(record));  
26     while (!inventory.eof())  
27     {  
28         cout << "Description: ";  
29         cout << record.desc << endl;  
30         cout << "Quantity: ";  
31         cout << record.qty << endl;  
32         cout << "Price: ";  
33         cout << record.price << endl << endl;  
34         inventory.read(reinterpret_cast<char  
*>(&record),  
35                     sizeof(record));  
36     }  
37  
38     // Close the file.  
39     inventory.close();  
40     return 0;  
41 }
```

Here is the screen output of [Program 12-21](#) if it is run immediately after [Program 12-20](#) sets up the file of blank records.

## Program 12-21

### Program Output

```
Description:
```

```
Quantity: 0
```

```
Price: 0.0
```

```
Description:
```

```
Quantity: 0
```

```
Price: 0.0
```

```
Description:
```

```
Quantity: 0
```

```
Price: 0.0
```

```
Description:
```


```
Quantity: 0
```

```
Price: 0.0
```

```
Description:
```

```
Quantity: 0
```

```
Price: 0.0
```

**Program 12-22**  allows the user to change the contents of an individual record in the inventory file.

## Program 12-22

```
1 // This program allows the user to edit a
specific record.
2 #include <iostream>
3 #include <fstream>
4 using namespace std;
5
6 const int DESC_SIZE = 31; // Description size
7
8 // Declaration of InventoryItem structure
9 struct InventoryItem
10 {
11     char desc[DESC_SIZE];
12     int qty;
13     double price;
14 };
15
16 int main()
17 {
18     InventoryItem record; // To hold an
inventory record
19     long recNum; // To hold a record
number
20
```

```
21     // Open the file in binary mode for input
and output
22     fstream inventory("Inventory.dat",
23                       ios::in | ios::out |
ios::binary);
24
25     // Get the record number of the desired
record.
26     cout << "Which record do you want to edit?
";
27     cin >> recNum;
28
29     // Move to the record and read it.
30     inventory.seekg(recNum * sizeof(record),
ios::beg);
31     inventory.read(reinterpret_cast<char *>
(&record),
32                   sizeof(record));
33
34     // Display the record contents.
35     cout << "Description: ";
36     cout << record.desc << endl;
37     cout << "Quantity: ";
38     cout << record.qty << endl;
39     cout << "Price: ";
40     cout << record.price << endl;
41
```



```

42     // Get the new record data.
43     cout << "Enter the new data:\n";
44     cout << "Description: ";
45     cin.ignore();
46     cin.getline(record.desc, DESC_SIZE);
47     cout << "Quantity: ";
48     cin >> record.qty;
49     cout << "Price: ";
50     cin >> record.price;
51
52     // Move back to the beginning of this
record's position.
53     inventory.seekp(recNum * sizeof(record),
ios::beg);
54
55     // Write the new record over the current
record.
56     inventory.write(reinterpret_cast<char *>
(&record),
57                     sizeof(record));
58
59     // Close the file.
60     inventory.close();
61     return 0;
62 }

```

**Program Output with Example Input Shown in Bold**

Which record do you want to edit? **2** Enter

Description:

Quantity: 0

Price: 0.0

Enter the new data:

Description: **Wrench** Enter

Quantity: **10** Enter

Price: **4.67** Enter



# Checkpoint

12.10 Describe the difference between the `seekg` and the `seekp` functions.

12.11 Describe the difference between the `tellg` and the `tellp` functions.

12.12 Describe the meaning of the following file access flags:

```
ios::beg
ios::end
ios::cur
```

12.13 What is the number of the first byte in a file?

12.14 Briefly describe what each of the following statements does:

```
file.seekp(100L, ios::beg);
file.seekp(-10L, ios::end);
file.seekg(-25L, ios::cur);
file.seekg(30L, ios::cur);
```

12.15 Describe the mode that each of the following statements causes a file to be opened in:

```
file.open("info.dat", ios::in | ios::out);  
file.open("info.dat", ios::in | ios::app);  
file.open("info.dat", ios::in | ios::out | ios::ate);  
file.open("info.dat", ios::in | ios::out | ios::binary);
```

For another example of this chapter's topics, see the High Adventure Travel Part 3 Case Study, available on the Computer Science Portal at [www.pearsonhighered.com/gaddis](http://www.pearsonhighered.com/gaddis).

# Review Questions and Exercises

## Short Answer

1. What capability does the `fstream` data type provide that the `ifstream` and `ofstream` data types do not?
2. Which file access flag do you use to open a file when you want all output written to the end of the file's existing contents?
3. Assume the file `data.txt` already exists, and the following statement executes. What happens to the file?  

```
fstream file("data.txt", ios::out);
```
4. How do you combine multiple file access flags when opening a file?
5. Should file stream objects be passed to functions by value or by reference? Why?
6. Under what circumstances is a file stream object's `ios::hardfail` bit set? What member function reports the state of this bit?
7. Under what circumstances is a file stream object's `ios::eofbit` bit set? What member function reports the state of this bit?

8. Under what circumstances is a file stream object's `ios::badbit` bit set? What member function reports the state of this bit?
9. How do you read the contents of a text file that contains whitespace characters as part of its data?
10. What arguments do you pass to a file stream object's `write` member function?
11. What arguments do you pass to a file stream object's `read` member function?
12. What type cast do you use to convert a pointer from one type to another?
13. What is the difference between the `seekg` and `seekp` member functions?
14. How do you get the byte number of a file's current read position? How do you get the byte number of a file's current write position?
15. If a program has read to the end of a file, what must you do before using either the `seekg` or `seekp` member function?
16. How do you determine the number of bytes that a file contains?
17. How do you rewind a sequential-access file?

# Fill-in-the-Blank

18. The \_\_\_\_\_ file stream data type is for output files, input files, or files that perform both input and output.
19. If a file fails to open, the file stream object will be set to \_\_\_\_\_.
20. The same formatting techniques used with \_\_\_\_\_ may also be used when writing data to a file.
21. The \_\_\_\_\_ function reads a line of text from a file.
22. The \_\_\_\_\_ member function reads a single character from a file.
23. The \_\_\_\_\_ member function writes a single character to a file.
24. \_\_\_\_\_ files contain data that is unformatted and not necessarily stored as ASCII text.
25. \_\_\_\_\_ files contain data formatted as \_\_\_\_\_.
26. A(n) \_\_\_\_\_ is a complete set of data about a single item and is made up of \_\_\_\_\_.
27. In C++, \_\_\_\_\_ provide a convenient way to organize data into fields and records.
28. The \_\_\_\_\_ member function writes “raw” binary data to a file.
29. The \_\_\_\_\_ member function reads “raw” binary data from a file.
30. The \_\_\_\_\_ operator is necessary if you pass anything other than a pointer-to-char as the first argument of the two functions mentioned in Questions 26 and 27.

31. In \_\_\_\_\_ file access, the contents of the file are read in the order they appear in the file, from the file's start to its end.
32. In \_\_\_\_\_ file access, the contents of a file may be read in any order.
33. The \_\_\_\_\_ member function moves a file's read position to a specified byte in the file.
34. The \_\_\_\_\_ member function moves a file's write position to a specified byte in the file.
35. The \_\_\_\_\_ member function returns a file's current read position.
36. The \_\_\_\_\_ member function returns a file's current write position.
37. The \_\_\_\_\_ mode flag causes an offset to be calculated from the beginning of a file.
38. The \_\_\_\_\_ mode flag causes an offset to be calculated from the end of a file.
39. The \_\_\_\_\_ mode flag causes an offset to be calculated from the current position in the file.
40. A negative offset causes the file's read or write position to be moved \_\_\_\_\_ in the file from the position specified by the mode.



# Algorithm Workbench

41. Write a statement that defines a file stream object named `places`. The object will be used for both output and input.
42. Write two statements that use a file stream object named `people` to open a file named `people.dat`. (Show how to open the file with a member function and at the definition of the file stream object.) The file should be opened for output.
43. Write two statements that use a file stream object named `pets` to open a file named `pets.dat`. (Show how to open the file with a member function and at the definition of the file stream object.) The file should be opened for input.
44. Write two statements that use a file stream object named `places` to open a file named `places.dat`. (Show how to open the file with a member function and at the definition of the file stream object.) The file should be opened for both input and output.
45. Write a program segment that defines a file stream object named `employees`. The file should be opened for both input and output (in binary mode). If the file fails to open, the program segment should display an error message.
46. Write code that opens the file `data.txt` for both input and output, but first determines if the file exists. If the file does not exist, the code should create it, then open it for both input and output.
47. Write code that determines the number of bytes contained in the file associated with the file stream object `dataFile`.

48. The `infoFile` file stream object is used to sequentially access data. The program has already read to the end of the file. Write code that rewinds the file.

# True or False

49. T F Different operating systems have different rules for naming files.
50. T F `fstream` objects are only capable of performing file output operations.
51. T F `ofstream` objects, by default, delete the contents of a file if it already exists when opened.
52. T F `ifstream` objects, by default, create a file if it doesn't exist when opened.
53. T F Several file access flags may be joined by using the `|` operator.
54. T F A file may be opened in the definition of the file stream object.
55. T F If a file is opened in the definition of the file stream object, no mode flags may be specified.
56. T F A file stream object's `fail` member function may be used to determine if the file was successfully opened.
57. T F The same output formatting techniques used with `cout` may also be used with file stream objects.
58. T F The `>>` operator expects data to be delimited by whitespace characters.
59. T F The `getline` member function can be used to read text that contains whitespaces.
60. T F It is not possible to have more than one file open at once in a program.

61. T F Binary files contain unformatted data, not necessarily stored as text.
62. T F Binary is the default mode in which files are opened.
63. T F The `tellp` member function tells a file stream object which byte to move its write position to.
64. T F It is possible to open a file for both input and output.

# Find the Error

Each of the following programs or program segments has errors.  
Find as many as you can.

65. 

```
fstream file(ios::in | ios::out);  
file.open("info.dat");  
if (!file)  
{  
    cout << "Could not open file.\n";  
}
```

66. 

```
ofstream file;  
file.open("info.dat", ios::in);  
if (file)  
{  
    cout << "Could not open file.\n";  
}
```

67.

```
fstream file("info.dat");  
if (!file)  
{  
    cout << "Could not open file.\n";  
}
```

68.

```
fstream dataFile("info.dat", ios:in | ios:binary);  
int x = 5;  
dataFile << x;
```

69.

```
fstream dataFile("info.dat", ios:in);  
char stuff[81];  
dataFile.get(stuff);
```

70.

```
fstream dataFile("info.dat", ios:in);  
char stuff[81] = "abcdefghijklmnopqrstuvwxyz";  
dataFile.put(stuff);
```

71. `fstream dataFile("info.dat", ios:out);`  
`struct Date`  
`{`  
 `int month;`  
 `int day;`  
 `int year;`  
`};`  
`Date dt = { 4, 2, 98 };`  
`dataFile.write(&dt, sizeof(int));`

72. `fstream inFile("info.dat", ios:in);`  
`int x;`  
`inFile.seekp(5);`  
`inFile >> x;`

# Programming Challenges

## 1. File Head Program

Write a program that asks the user for the name of a file. The program should display the first ten lines of the file on the screen (the “head” of the file). If the file has fewer than ten lines, the entire file should be displayed, with a message indicating the entire file has been displayed.



### Note:

Using an editor, you should create a simple text file that can be used to test this program.

## 2. File Display Program

Write a program that asks the user for the name of a file. The program should display the contents of the file on the screen. If the file’s contents won’t fit on a single screen, the program should display 24 lines of output at a time, then pause. Each time the program pauses, it should wait for the user to strike a key before the next 24 lines are displayed.





## Note:

Using an editor, you should create a simple text file that can be used to test this program.

### 3. Punch Line

Write a program that reads and prints a joke and its punch line from two different files. The first file contains a joke, but not its punch line. The second file has the punch line as its last line, preceded by “garbage.” The `main` function of your program should open the two files then call two functions, passing each one the file it needs. The first function should read and display each line in the file it is passed (the joke file). The second function should display only the last line of the file it is passed (the punch line file). It should find this line by seeking to the end of the file and then backing up to the beginning of the last line. Data to test your program can be found in the `joke.txt` and `punchline.txt` files.

### 4. Tail Program

Write a program that asks the user for the name of a file. The program should display the last ten lines of the file on the screen (the “tail” of the file). If the file has fewer than ten lines, the entire file should be displayed, with a message indicating the entire file has been displayed.



## Note:

Using an editor, you should create a simple text file that can be used to test this program.

### 5. Line Numbers

(This assignment could be done as a modification of the program in Programming Challenge 2.) Write a program that asks the user for the name of a file. The program should display the contents of the file on the screen. Each line of screen output should be preceded with a line number, followed by a colon. The line numbering should start at 1.

Here is an example:

```
1:George Rolland
```

```
2:127 Academy Street
```

```
3:Brasstown, NC 28706
```

If the file's contents won't fit on a single screen, the program should display 24 lines of output at a time, and then pause. Each time the program pauses, it should wait for the user to strike a key before the next 24 lines are displayed.



### **Note:**

Using an editor, you should create a simple text file that can be used to test this program.

## **6. String Search**

Write a program that asks the user for a file name and a string for which to search. The program should search the file for every occurrence of a specified string. When the string is found, the line that contains it should be displayed. After all the occurrences have been located, the program should report the number of times the string appeared in the file.



### **Note:**

Using an editor, you should create a simple text file that can be used to test this program.

## **7. Sentence Filter**

Write a program that asks the user for two file names. The first file will be opened for input, and the second file will be opened for output. (It will be assumed the first file contains sentences that end with a period.) The program will read the contents of the first file and change all the letters to lowercase except the first letter of each sentence, which should be made

uppercase. The revised contents should be stored in the second file.



### Note:

Using an editor, you should create a simple text file that can be used to test this program.

## 8. Array/File Functions

Write a function named `arrayToFile`. The function should accept three arguments: the name of a file, a pointer to an `int` array, and the size of the array. The function should open the specified file in binary mode, write the contents of the array to the file, and then close the file.

Write another function named `fileToArray`. This function should accept three arguments: the name of a file, a pointer to an `int` array, and the size of the array. The function should open the specified file in binary mode, read its contents into the array, and then close the file.

Write a complete program that demonstrates these functions by using the `arrayToFile` function to write an array to a file, then using the `fileToArray` function to read the data from the same file. After the data are read from the file into the array, display the array's contents on the screen.

## 9. File Encryption Filter

File encryption is the science of writing the contents of a file in a secret code. Your encryption program should work like a

filter, reading the contents of one file, modifying the data into a code, then writing the coded contents out to a second file. The second file will be a version of the first file, but written in a secret code.



## **Solving the File Encryption Filter Problem**

Although there are complex encryption techniques, you should come up with a simple one of your own. For example, you could read the first file one character at a time, and add 10 to the ASCII code of each character before it is written to the second file.

### **10. File Decryption Filter**

Write a program that decrypts the file produced by the program in Programming Challenge 9. The decryption program should read the contents of the coded file, restore the data to its original state, and write it to another file.

### **11. Corporate Sales Data Output**

Write a program that uses a structure to store the following data on a company division:

- Division Name (such as East, West, North, or South)
- Quarter (1, 2, 3, or 4)
- Quarterly Sales

The user should be asked for the four quarters' sales figures for the East, West, North, and South divisions. The data for each quarter for each division should be written to a file.

*Input Validation: Do not accept negative numbers for any sales figures.*

## 12. Corporate Sales Data Input

Write a program that reads the data in the file created by the program in Programming Challenge 11. The program should calculate and display the following figures:

- Total corporate sales for each quarter
- Total yearly sales for each division
- Total yearly corporate sales
- Average quarterly sales for the divisions
- The highest and lowest quarters for the corporation

## 13. Inventory Program

Write a program that uses a structure to store the following inventory data in a file:

- Item Description
- Quantity on Hand
- Wholesale Cost
- Retail Cost
- Date Added to Inventory

The program should have a menu that allows the user to perform the following tasks:

- Add new records to the file
- Display any record in the file
- Change any record in the file


*Input Validation: The program should not accept quantities, or wholesale or retail costs, less than 0. The program should not accept dates that the programmer determines are unreasonable.*

#### 14. **Inventory Screen Report**

Write a program that reads the data in the file created by the program in Programming Challenge 13. The program should calculate and display the following data:

- The total wholesale value of the inventory
- The total retail value of the inventory
- The total quantity of all items in the inventory

#### 15. **Average Number of Words**

If you have downloaded this book's source code, you will find a file named text.txt in the **Chapter 12**  folder. The text that is in the file is stored as one sentence per line. Write a program that reads the file's contents and calculates the average number of words per sentence.

# Group Project

## 16. Customer Accounts

This program should be designed and written by a team of students. Here are some suggestions:

- One student should design function `main`, which will call other program functions. The remainder of the functions will be designed by other members of the team.
- The requirements of the program should be analyzed so that each student is given about the same workload.

Write a program that uses a structure to store the following data about a customer account:

- Name
- Address
- City, State, and ZIP
- Telephone Number
- Account Balance
- Date of Last Payment

The structure should be used to store customer account records in a file. The program should have a menu that lets the user perform the following operations:

- Enter new records into the file
- Search for a particular customer's record and display it
- Search for a particular customer's record and delete it



- Search for a particular customer's record and change it
- Display the contents of the entire file

*Input Validation: When the data for a new account is entered, be sure the user enters data for all the fields. No negative account balances should be entered.*

---

# Chapter 13 Introduction to Classes

---

## Topics

13.1 Procedural and Object-Oriented Programming [📄](#)

13.2 Introduction to Classes [📄](#)

13.3 Defining an Instance of a Class [📄](#)

13.4 Why Have Private Members? [📄](#)

13.5 Focus on Software Engineering: Separating Class Specification from Implementation [📄](#)

13.6 Inline Member Functions [📄](#)

13.7 Constructors [📄](#)

13.8 Passing Arguments to Constructors [📄](#)

13.9 Destructors [📄](#)

13.10 Overloading Constructors [📄](#)

**13.11 Private Member Functions** 

**13.12 Arrays of Objects** 

**13.13 Focus on Problem Solving and Program Design: An OOP Case Study** 

**13.14 Focus on Object-Oriented Programming: Simulating Dice with Objects** 

**13.15 Focus on Object-Oriented Design: The Unified Modeling Language (UML)** 

**13.16 Focus on Object-Oriented Design: Finding the Classes and Their Responsibilities** 

# 13.1 Procedural and Object-Oriented Programming

## Concept:

Procedural programming is a method of writing software. It is a programming practice centered on the procedures or actions that take place in a program. Object-oriented programming is centered around the object. Objects are created from abstract data types that encapsulate data and functions together.

There are two common programming methods in practice today: procedural programming and object-oriented programming (or OOP). Up to this chapter, you have learned to write procedural programs.

In a procedural program, you typically have data stored in a collection of variables and/or structures, coupled with a set of functions that perform operations on the data. The data and the functions are separate entities. For example, in a program that works with the geometry of a rectangle you might have the variables in [Table 13-1](#).

### Table 13-1 Variables Related to a Rectangle

In addition to the variables listed in [Table 13-1](#), you might also have the functions listed in [Table 13-2](#).

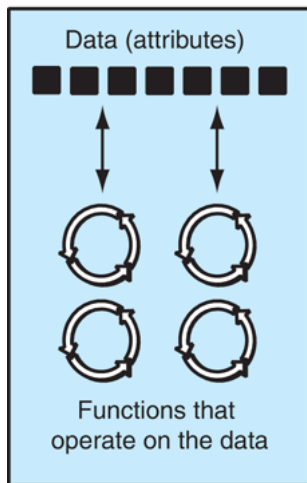
### Table 13-2 Functions Related to a Rectangle

Usually the variables and data structures in a procedural program are passed to the functions that perform the desired operations. As you might imagine, the focus of procedural programming is on creating the functions that operate on the program's data.

Procedural programming has worked well for software developers for many years. However, as programs become larger and more complex, the separation of a program's data and the code that operates on the data can lead to problems. For example, the data in a procedural program are stored in variables, as well as more complex structures that are created from variables. The procedures that operate on the data must be designed with those variables and data structures in mind. But what happens if the format of the data is altered? Quite often, a program's specifications change, resulting in redesigned data structures. When the structure of the data changes, the code that operates on the data must also change to accept the new format. This results in additional work for programmers and a greater opportunity for bugs to appear in the code.

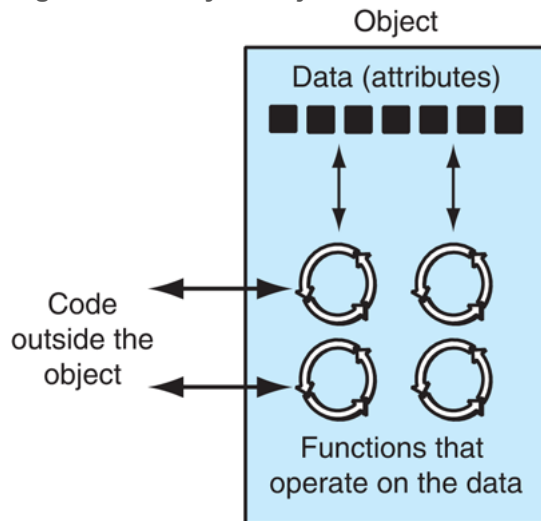
This problem has helped influence the shift from procedural programming to object-oriented programming (OOP). Whereas procedural programming is centered on creating procedures or functions, object-oriented programming is centered on creating objects. An *object* is a software entity that contains both data and procedures. The data contained in an object are known as the object's *attributes*. The procedures an object performs are called *member functions*. The object is, conceptually, a self-contained unit consisting of attributes (data) and procedures (functions). This is illustrated in [Figure 13-1](#).

**Figure 13-1 An object contains data and procedures**  
Object



OOP addresses the problems that can result from the separation of code and data through encapsulation and data hiding. *Encapsulation* refers to the combining of data and code into a single object. *Data hiding* refers to an object's ability to hide its data from code that is outside the object. Only the object's member functions may directly access and make changes to the object's data. An object typically hides its data, but allows outside code to access its member functions. As shown in [Figure 13-2](#), the object's member functions provide programming statements outside the object with indirect access to the object's data.

Figure 13-2 Only an object's member functions may access the object's data



**Note:**

In other programming languages, the procedures an object performs are often called *methods*.

When an object's internal data are hidden from outside code, and access to that data is restricted to the object's member functions, the data are protected from accidental corruption. In addition, the programming code outside the object does not need to know about the format or internal structure of the object's data. The code only needs to interact with the object's functions. When a programmer changes the structure of an object's internal data, he or she also modifies the object's member functions so they may properly operate on the data. The way in which outside code interacts with the member functions, however, does not change.

An everyday example of object-oriented technology is the automobile. It has a rather simple interface that consists of an ignition switch, steering wheel, gas pedal, brake pedal, and a gear shift. Vehicles with manual transmissions also provide a clutch pedal. If you want to drive an automobile (to become its user), you only have to learn to operate these elements of its interface. To start the motor, you simply turn the key in the ignition switch. What happens internally is irrelevant to the user. If you want to steer the auto to the left, you rotate the steering wheel left. The movements of all the linkages connecting the steering wheel to the front tires occur transparently.

Because automobiles have simple user interfaces, they can be driven by people who have no mechanical knowledge. This is good for the makers of automobiles because it means more people are likely to become customers. It's good for the users of automobiles because they can learn just a few simple procedures and operate almost any vehicle.

These are also valid concerns in software development. A real-world program is rarely written by only one person. Even the programs you have created so far weren't written entirely by you. If you incorporated C++ library functions, or objects like `cin` and `cout`, you used code written by someone else. In the world of professional software development, programmers commonly work in teams, buy and sell their code, and collaborate on projects. With OOP, programmers can create objects with powerful engines tucked away "under the hood," protected by simple interfaces that safeguard the object's algorithms.

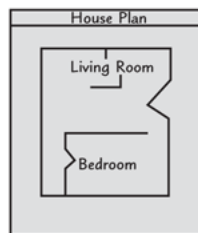
## Object Reusability

In addition to solving the problems of code/data separation, the use of OOP has also been encouraged by the trend of *object reusability*. An object is not a stand-alone program, but is used by programs that need its service. For example, Sharon is a programmer who has developed an object for rendering 3D images. She is a math whiz and knows a lot about computer graphics, so her object is coded to perform all the necessary 3D mathematical operations and handle the computer's video hardware. Tom, who is writing a program for an architectural firm, needs his application to display 3D images of buildings. Because he is working under a tight deadline and does not possess a great deal of knowledge about computer graphics, he can use Sharon's object to perform the 3D rendering (for a small fee, of course!).

# Classes and Objects

Now let's discuss how objects are created in software. Before an object can be created, it must be designed by a programmer. The programmer determines the attributes and functions that are necessary then creates a class. A *class* is code that specifies the attributes and member functions that a particular type of object may have. Think of a class as a "blueprint" from which objects may be created. It serves a similar purpose as the blueprint for a house. The blueprint itself is not a house, but is a detailed description of a house. When we use the blueprint to build an actual house, we could say we are building an instance of the house described by the blueprint. If we so desire, we can build several identical houses from the same blueprint. Each house is a separate instance of the house described by the blueprint. This idea is illustrated in [Figure 13-3](#).

**Figure 13-3 A blueprint describes a house**  
Blueprint that describes a house.



Instances of the house described by the blueprint.



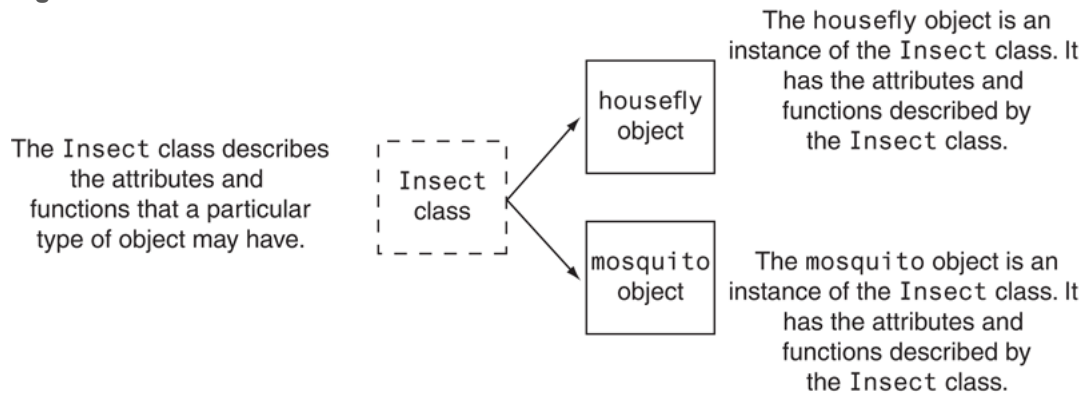
So, a class is not an object, but it is a description of an object. When the program is running, it uses the class to create, in memory, as many objects of a specific type as needed. Each object that is created from a class is called an *instance* of the class.

For example, Jessica is an entomologist (someone who studies insects), and she also enjoys writing computer programs. She designs a program to catalog different types of insects. As part of the program, she creates a class named `Insect`, which specifies attributes and member functions for holding and manipulating data common to all types of insects. The `Insect` class is not an object, but a specification that objects may be created from. Next, she writes programming statements that create a `housefly` object, which is an instance of the `Insect` class. The `housefly` object is an entity that occupies computer memory and stores data about a housefly. It has the attributes and member functions



specified by the `Insect` class. Then she writes programming statements that create a `mosquito` object. The `mosquito` object is also an instance of the `Insect` class. It has its own area in memory and stores data about a mosquito. Although the `housefly` and `mosquito` objects are two separate entities in the computer's memory, they were both created from the `Insect` class. This means that each of the objects has the attributes and member functions described by the `Insect` class. This is illustrated in [Figure 13-4](#).

**Figure 13-4 Instances of a class**



At the beginning of this section, we discussed how a procedural program that works with rectangles might have variables to hold the rectangle's width and length and separate functions to do things like store values in the variables and make calculations. The program would pass the variables to the functions as needed. In an object-oriented program, we would create a `Rectangle` class, which would encapsulate the data (width and length) and the functions that work with the data. [Figure 13-5](#) shows a representation of such a class.

**Figure 13-5 A class encapsulates data and functions**

<p><b>Member Variables</b></p> <pre>double width; double length;</pre>
<p><b>Member Functions</b></p> <pre>void setWidth(double w) { ... function code ...}  void setLength(double len) { ... function code ...}  double getWidth() { ... function code ...}  double getLength() { ... function code ...}  double getArea() { ... function code ...}</pre>

In the object-oriented approach, the variables and functions are all members of the `Rectangle` class. When we need to work with a rectangle in our program, we create a `Rectangle` object, which is an instance of the `Rectangle` class. When we need to perform an operation on the `Rectangle` object's data, we use that object to call the appropriate member function. For example, if we need to get the area of the rectangle, we use the object to call the `getArea` member function. The `getArea` member function would be designed to calculate the area of that object's rectangle and return the value.

# Using a Class You Already Know

Before we go any further, let's review the basics of a class that you have already learned something about: the `string` class. First, recall that you must have the following `#include` directive in any program that uses the `string` class:

```
#include <string>
```

This is necessary because the `string` class is declared in the `<string>` header file. Next, you can define a `string` object with a statement such as

```
string cityName;
```

This creates a `string` object named `cityName`. The `cityName` object is an instance of the `string` class.

Once a `string` object has been created, you can store data in it. Because the `string` class is designed to work with the assignment operator, you can assign a string literal to a `string` object. Here is an example:

```
cityName = "Charleston";
```

After this statement executes, the string `"Charleston"` will be stored in the `cityName` object. `"Charleston"` will become the object's data.

The `string` class specifies numerous member functions that perform operations on the data that a `string` object holds. For example, it has a member function named `length`, which returns the length of the string stored in a `string` object. The following code demonstrates:

```
string cityName;           // Create a string object named cityName
int strSize;              // To hold the length of a string
cityName = "Charleston";  // Assign "Charleston" to cityName
strSize = cityName.length(); // Store the string length in strSize
```

The last statement calls the `length` member function, which returns the length of a string. The expression `cityName.length()` returns the length of the string stored in the `cityName` object. After this statement executes, the `strSize` variable will contain the value 10, which is the length of the string `"Charleston"`.

The `string` class also specifies a member function named `append`, which appends an additional string onto the string already stored in an object. The following code demonstrates this:

```
string cityName;  
cityName = "Charleston";  
cityName.append(" South Carolina");
```

In the second line, the string `"Charleston"` is assigned to the `cityName` object. In the third line, the `append` member function is called and `" South Carolina"` is passed as an argument. The argument is appended to the string that is already stored in `cityName`. After this statement executes, the `cityName` object will contain the string `"Charleston South Carolina"`.

## 13.2 Introduction to Classes

### **Concept:**

In C++, the class is the construct primarily used to create objects.



### **Writing a Class**

A *class* is similar to a structure. It is a data type defined by the programmer, consisting of variables and functions. Here is the general format of a class declaration:

```
class ClassName
{
    declaration;
    // ... more declarations
    // may follow...
};
```

The declaration statements inside a class declaration are for the variables and functions that are members of that class. For example, the following code declares a class named `Rectangle` with two member variables: `width` and `length`.

```
class Rectangle
{
    double width;
    double length;
}; // Don't forget the semicolon.
```

There is a problem with this class, however. Unlike structures, the members of a class are *private* by default. Private class members cannot be accessed by programming statements outside the class. So, no statements outside this `Rectangle` class can access the `width` and `length` members.

Recall from our earlier discussion on object-oriented programming that an object can perform data hiding, which means that critical data stored inside the object are protected from code outside the object. In C++, a class's private members are hidden and can be accessed only by functions that are members of the same class. A class's *public* members may be accessed by code outside the class.

# Access Specifiers

C++ provides the key words `private` and `public`, which you may use in class declarations. These key words are known as *access specifiers* because they specify how class members may be accessed. The following is the general format of a class declaration that uses the `private` and `public` access specifiers:

```
class ClassName
{
    private:
        // Declarations of private
        // members appear here.
    public:
        // Declarations of public
        // members appear here.
};
```

Notice the access specifiers are followed by a colon (:) then followed by one or more member declarations. In this general format, the `private` access specifier is used first. All of the declarations that follow it, up to the `public` access specifier, are for private members. Then, all of the declarations that follow the `public` access specifier are for public members.



# Public Member Functions

To allow access to a class's private member variables, you create public member functions that work with the private member variables. For example, consider the `Rectangle` class. To allow access to a `Rectangle` object's `width` and `length` member variables, we will add the member functions listed in [Table 13-3](#).

## Table 13-3 The `Rectangle` Class's Member Functions

For the moment, we will not actually define the functions described in [Table 13-3](#). We leave that for later. For now, we will only include declarations, or prototypes, for the functions in the class declaration.

```
class Rectangle
{
    private:
        double width;
        double length;
    public:
        void setWidth(double);
        void setLength(double);
        double getWidth() const;
        double getLength() const;
        double getArea() const;
};
```

In this declaration, the member variables `width` and `length` are declared as `private`, which means they can be accessed only by the class's member functions. The member functions, however, are declared as `public`, which means they can be called from statements outside the class. If code outside the class needs to store a width or a length in a `Rectangle` object, it must do so by calling the object's `setWidth` or `setLength` member functions. Likewise, if code outside the class needs to retrieve a width or length stored in a `Rectangle` object, it must do so with the object's `getWidth` or `getLength` member functions. These public functions provide an interface for code outside the class to use `Rectangle` objects.



### **Note:**

Even though the default access of a class is private, it's still a good idea to use the `private` key word to explicitly declare private members. This clearly documents the access specification of all the members of the class.

# Using `const` with Member Functions

Notice the key word `const` appears in the declarations of the `getWidth`, `getLength`, and `getArea` member functions, as shown here:

```
double getWidth() const;  
double getLength() const;  
double getArea() const;
```

When the key word `const` appears after the parentheses in a member function declaration, it specifies that the function will not change any data stored in the calling object. If you inadvertently write code in the function that changes the calling object's data, the compiler will generate an error. As you will see momentarily, the `const` key word must also appear in the function header.

# Placement of `public` and `private` Members

There is no rule requiring you to declare private members before public members. The `Rectangle` class could be declared as follows:

```
class Rectangle
{
    public:
        void setWidth(double);
        void setLength(double);
        double getWidth() const;
        double getLength() const;
        double getArea() const;

    private:
        double width;
        double length;
};
```

In addition, it is not required that all members of the same access specification be declared in the same place. Here is yet another declaration of the `Rectangle` class.

```
class Rectangle
{
    private:
        double width;

    public:
        void setWidth(double);
        void setLength(double);
        double getWidth() const;
        double getLength() const;
        double getArea() const;

    private:
        double length;
};
```

Although C++ gives you freedom in arranging class member declarations, you should adopt a consistent standard. Most programmers choose to group member declarations of the same access specification together.



**Note:**

Notice in our example the first character of the class name is written in uppercase. This is not required, but serves as a visual reminder that the class name is not a variable name.

# Defining Member Functions

The `Rectangle` class declaration contains declarations or prototypes for five member functions: `setWidth`, `setLength`, `getWidth`, `getLength`, and `getArea`. The definitions of these functions are written outside the class declaration.



```

//*****
*
// setWidth assigns its argument to the private member width.  *
//*****

void Rectangle::setWidth(double w)
{
    width = w;
}

//*****
**
// setLength assigns its argument to the private member length.
*
//*****
**

void Rectangle::setLength(double len)
{
    length = len;
}

//*****

// getWidth returns the value in the private member width.  *
//*****

double Rectangle::getWidth() const
{
    return width;
}

//*****

// getLength returns the value in the private member length.  *

```

```

//*****
double Rectangle::getLength() const
{
    return length;
}
//*****
// getArea returns the product of width times length. *
//*****
double Rectangle::getArea() const
{
    return width * length;
}

```

In each function definition, the following precedes the name of each function:

```
Rectangle::
```

The two colons are called the *scope resolution operator*. When `Rectangle::` appears before the name of a function in a function header, it identifies the function as a member of the `Rectangle` class.

Here is the general format of the function header of any member function defined outside the declaration of a class:

```
ReturnType ClassName::functionName(ParameterList)
```

In the general format, *ReturnType* is the function's return type. *ClassName* is the name of the class of which the function is a member. *functionName* is the name of the member function. *ParameterList* is an optional list of parameter variable declarations.



## ***Warning!***

Remember, the class name and scope resolution operator extends the name of the function. They must appear after the return type and immediately before the function name in the function header. The following would be incorrect:

```
Rectangle::double getArea() //Incorrect!
```

In addition, if you leave the class name and scope resolution operator out of a member function's header, the function will not become a member of the class.

```
double getArea() // Not a member of the Rectangle class!
```

# Accessors and Mutators

As mentioned earlier, it is a common practice to make all of a class's member variables private, and to provide public member functions for accessing and changing them. This ensures that the object owning the member variables is in control of all changes being made to them. A member function that gets a value from a class's member variable but does not change it is known as an *accessor*. A member function that assigns a value to a member variable is known as a *mutator*. In the `Rectangle` class, the member functions `getLength` and `getWidth` are accessors, and the member functions `setLength` and `setWidth` are mutators.

Some programmers refer to mutators as *setter functions* because they set the value of an attribute, and accessors as *getter functions* because they get the value of an attribute.

# Using `const` with Accessors

Notice the key word `const` appears in the headers of the `getWidth`, `getLength`, and `getArea` member functions, as shown here:

```
double Rectangle::getWidth() const
double Rectangle::getLength() const
double Rectangle::getArea() const
```

Recall that these functions were also declared in the class with the `const` key word. When you mark a member function as `const`, the `const` key word must appear in both the declaration and the function header.

In essence, when you mark a member function as `const`, you are telling the compiler that the calling object is a constant. The compiler will generate an error if you inadvertently write code in the function that changes the calling object's data. Because this decreases the chances of having bugs in your code, it is a good practice to mark all accessor functions as `const`.

# The Importance of Data Hiding

As a beginning student, you might be wondering why you would want to hide the data that is inside the classes you create. As you learn to program, you will be the user of your own classes, so it might seem that you are putting forth a great effort to hide data from yourself. If you write software in industry, however, the classes that you create will be used as components in large software systems; programmers other than yourself will use your classes. By hiding a class's data and allowing it to be accessed through only the class's member functions, you can better ensure that the class will operate as you intended.

## 13.3 Defining an Instance of a Class

### Concept:

Class objects must be defined after the class is declared.

Like structure variables, class objects are not created in memory until they are defined. This is because a class declaration by itself does not create an object, but is merely the description of an object. We can use it to create one or more objects, which are instances of the class.



### Defining an Instance of a Class

Class objects are created with simple definition statements, just like variables. Here is the general format of a simple object definition statement:

```
ClassName objectName;
```

In the general format, *ClassName* is the name of a class, and *objectName* is the name we are giving the object.

For example, the following statement defines `box` as an object of the `Rectangle` class:

```
Rectangle box;
```

Defining a class object is called the *instantiation* of a class. In this statement, `box` is an *instance* of the `Rectangle` class.



# Accessing an Object's Members

The `box` object we previously defined is an instance of the `Rectangle` class. Suppose we want to change the value in the `box` object's `width` variable. To do so, we must use the `box` object to call the `setWidth` member function, as shown here:

```
box.setWidth(12.7);
```

Just as you use the dot operator to access a structure's members, you use the dot operator to call a class's member functions. This statement uses the `box` object to call the `setWidth` member function, passing 12.7 as an argument. As a result, the `box` object's `width` variable will be set to 12.7. Here are other examples of statements that use the `box` object to call member functions:


```
box.setLength(4.8);    // Set box's length to 4.8.
x = box.getWidth();   // Assign box's width to x.
cout << box.getLength(); // Display box's length.
cout << box.getArea();  // Display box's area.
```



## **Note:**

Notice inside the `Rectangle` class's member functions, the dot operator is not used to access any of the class's member variables. When an object is used to call a member function, the member function has direct access to that object's member variables.

# A Class Demonstration Program

**Program 13-1**  is a complete program that demonstrates the `Rectangle` class.

## Program 13-1

```
1 // This program demonstrates a simple class.
2 #include <iostream>
3 using namespace std;
4
5 // Rectangle class declaration.
6 class Rectangle
7 {
8     private:
9         double width;
10        double length;
11    public:
12        void setWidth(double);
13        void setLength(double);
14        double getWidth() const;
15        double getLength() const;
16        double getArea() const;
17 };
18
19 //*****
20 // setWidth assigns a value to the width member. *
21 //*****
22
23 void Rectangle::setWidth(double w)
24 {
25     width = w;
26 }
27
28 //*****
29 // setLength assigns a value to the length member. *
30 //*****
31
32 void Rectangle::setLength(double len)
33 {
34     length = len;
35 }
36
37 //*****
```

```

38 // getWidth returns the value in the width member. *
39 //*****
40
41 double Rectangle::getWidth() const
42 {
43     return width;
44 }
45
46 //*****
47 // getLength returns the value in the length member. *
48 //*****
49
50 double Rectangle::getLength() const
51 {
52     return length;
53 }
54
55 //*****
56 // getArea returns the product of width times length. *
57 //*****
58
59 double Rectangle::getArea() const
60 {
61     return width * length;
62 }
63
64 //*****
65 // Function main *
66 //*****
67
68 int main()
69 {
70     Rectangle box; // Define an instance of the Rectangle class
71     double rectWidth; // Local variable for width
72     double rectLength; // Local variable for length
73
74     // Get the rectangle's width and length from the user.
75     cout << "This program will calculate the area of a\n";
76     cout << "rectangle. What is the width? ";
77     cin >> rectWidth;
78     cout << "What is the length? ";

```

```

79     cin >> rectLength;
80
81     // Store the width and length of the rectangle
82     // in the box object.
83     box.setWidth(rectWidth);
84     box.setLength(rectLength);
85
86     // Display the rectangle's data.
87     cout << "Here is the rectangle's data:\n";
88     cout << "Width: " << box.getWidth() << endl;
89     cout << "Length: " << box.getLength() << endl;
90     cout << "Area: " << box.getArea() << endl;
91     return 0;
92 }

```

### Program Output with Example Input Shown in Bold

```

This program will calculate the area of a
rectangle. What is the width? 10 Enter
What is the length? 5 Enter
Here is the rectangle's data:
Width: 10
Length: 5
Area: 50

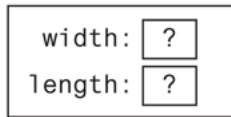
```

The `Rectangle` class declaration, along with the class's member functions, appears in lines 6 through 62. Inside the `main` function, in line 70, the following statement creates a `Rectangle` object named `box`:

```
Rectangle box;
```

The `box` object is illustrated in [Figure 13-6](#). Notice the `width` and `length` member variables do not yet hold meaningful values. An object's member variables are not automatically initialized to 0. When an object's member variable is first created, it holds whatever random value happens to exist at the variable's memory location. We commonly refer to such a random value as "garbage."

**Figure 13-6 State of the `box` object**  
The `box` object when first created

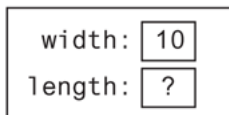


In lines 75 through 79, the program prompts the user to enter the width and length of a rectangle. The width that is entered is stored in the `rectWidth` variable, and the length that is entered is stored in the `rectLength` variable. In line 83 the following statement uses the `box` object to call the `setWidth` member function, passing the value of the `rectWidth` variable as an argument:

```
box.setWidth(rectWidth);
```

This sets `box`'s `width` member variable to the value in `rectWidth`. Assuming `rectWidth` holds the value 10, [Figure 13-7](#) shows the state of the `box` object after this statement executes.

**Figure 13-7 State of the `box` object**  
The `box` object with `width` set to 10

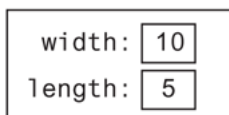


In line 84, the following statement uses the `box` object to call the `setLength` member function, passing the value of the `rectLength` variable as an argument:

```
box.setLength(rectLength);
```

This sets `box`'s `length` member variable to the value in `rectLength`. Assuming `rectLength` holds the value 5, [Figure 13-8](#) shows the state of the `box` object after this statement executes.

**Figure 13-8 State of the `box` object**  
The `box` object with `width` set to 10  
and `length` set to 5



Lines 88, 89, and 90 use the `box` object to call the `getWidth`, `getLength`, and `getArea` member functions, displaying their return values on the screen.



**Note:**

Figures 13-6 through 13-8 show the state of the box object at various times during the execution of the program. An object's *state* is simply the data that is stored in the object's attributes at any given moment.

Program 13-1 creates only one `Rectangle` object. It is possible to create many instances of the same class, each with its own data. For example, Program 13-2 creates three `Rectangle` objects, named `kitchen`, `bedroom`, and `den`. Note lines 6 through 62 have been left out of the listing because they contain the `Rectangle` class declaration and the definitions for the class's member functions. These lines are identical to those same lines in Program 13-1.

## Program 13-2

```
1 // This program creates three instances of the Rectangle class.
2 #include <iostream>
3 using namespace std;
4
5 // Rectangle class declaration.
6
7     Lines 6 through 62 have been left out.
8
9
10
11
12
13
14
15
16
17
18
19
20
21
22
23
24
25
26
27
28
29
30
31
32
33
34
35
36
37
38
39
40
41
42
43
44
45
46
47
48
49
50
51
52
53
54
55
56
57
58
59
60
61
62
63
64 /** *****
65  * Function main
66 /** *****
67
68 int main()
69 {
70     double number; // To hold a number
71     double totalArea; // The total area
72     Rectangle kitchen; // To hold kitchen dimensions
73     Rectangle bedroom; // To hold bedroom dimensions
74     Rectangle den; // To hold den dimensions
75
76     // Get the kitchen dimensions.
77     cout << "What is the kitchen's length? ";
78     cin >> number; // Get the length
79     kitchen.setLength(number); // Store in kitchen object
80     cout << "What is the kitchen's width? ";
81     cin >> number; // Get the width
82     kitchen.setWidth(number); // Store in kitchen object
83
84     // Get the bedroom dimensions.
85     cout << "What is the bedroom's length? ";
86     cin >> number; // Get the length
87     bedroom.setLength(number); // Store in bedroom object
88     cout << "What is the bedroom's width? ";
89     cin >> number; // Get the width
90     bedroom.setWidth(number); // Store in bedroom object
91
92     // Get the den dimensions.
93     cout << "What is the den's length? ";
```



```

94     cin >> number;                // Get the length
95     den.setLength(number);        // Store in den object
96     cout << "What is the den's width? ";
97     cin >> number;                // Get the width
98     den.setWidth(number);        // Store in den object
99
100    // Calculate the total area of the three rooms.
101    totalArea = kitchen.getArea() + bedroom.getArea() +
102             den.getArea();
103
104    // Display the total area of the three rooms.
105    cout << "The total area of the three rooms is "
106         << totalArea << endl;
107
108    return 0;
109 }

```

### Program Output with Example Input Shown in Bold

```

What is the kitchen's length? 10 Enter
What is the kitchen's width? 14 Enter
What is the bedroom's length? 15 Enter
What is the bedroom's width? 12 Enter
What is the den's length? 20 Enter
What is the den's width? 30 Enter
The total area of the three rooms is 920


```

In lines 72, 73, and 74, the following code defines three `Rectangle` variables. This creates three objects, each an instance of the `Rectangle` class:

```

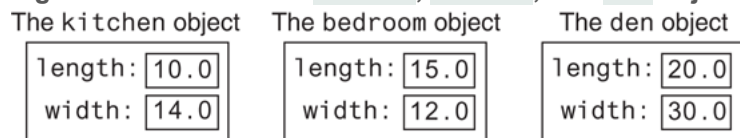
Rectangle kitchen; // To hold kitchen dimensions
Rectangle bedroom; // To hold bedroom dimensions
Rectangle den;     // To hold den dimensions

```

In the example output, the user enters 10 and 14 as the length and width of the kitchen, 15 and 12 as the length and width of the bedroom, and 20 and 30 as the length and width of the den. [Figure 13-9](#) 

shows the states of the objects after these values are stored in them.

**Figure 13-9 State of the `kitchen`, `bedroom`, and `den` objects**



Notice from [Figure 13-9](#) each instance of the `Rectangle` class has its own `length` and `width` variables. Every instance of a class has its own set of member variables that can hold their own values. The class's member functions can perform operations on specific instances of the class. For example, look at the following statement in line 79 of [Program 13-2](#):

```
kitchen.setLength(number);
```

This statement calls the `setLength` member function, which stores a value in the `kitchen` object's `length` variable. Now look at the following statement in line 87:

```
bedroom.setLength(number);
```

This statement also calls the `setLength` member function, but this time it stores a value in the `bedroom` object's `length` variable. Likewise, the following statement in line 95 calls the `setLength` member function to store a value in the `den` object's `length` variable:

```
den.setLength(number);
```

The `setLength` member function stores a value in a specific instance of the `Rectangle` class. All of the other `Rectangle` class member functions work in a similar way. They access one or more member variables of a specific `Rectangle` object.

# Avoiding Stale Data

In the `Rectangle` class, the `getLength` and `getWidth` member functions return the values stored in member variables, but the `getArea` member function returns the result of a calculation. You might be wondering why the area of the rectangle is not stored in a member variable, like the length and the width. The area is not stored in a member variable because it could potentially become stale. When the value of an item is dependent on other data and that item is not updated when the other data are changed, it is said that the item has become *stale*. If the area of the rectangle were stored in a member variable, the value of the member variable would become incorrect as soon as either the `length` or `width` member variables changed.

When designing a class, you should take care not to store in a member variable calculated data that could potentially become stale. Instead, provide a member function that returns the result of the calculation.

# Pointers to Objects

You can also define pointers to class objects. For example, the following statement defines a pointer variable named `rectPtr`:

```
Rectangle *rectPtr = nullptr;
```

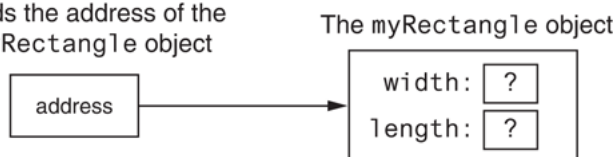
The `rectPtr` variable is not an object, but it can hold the address of a `Rectangle` object. The following code shows an example:

```
Rectangle myRectangle;           // A Rectangle object
Rectangle *rectPtr = nullptr;    // A Rectangle pointer
rectPtr = &myRectangle;         // rectPtr now points to myRectangle
```

The first statement creates a `Rectangle` object named `myRectangle`. The second statement creates a `Rectangle` pointer named `rectPtr`. The third statement stores the address of the `myRectangle` object in the `rectPtr` pointer. This is illustrated in [Figure 13-10](#).

**Figure 13-10** `rectPtr` points to the `myRectangle` object

The `rectPtr` pointer variable holds the address of the `myRectangle` object



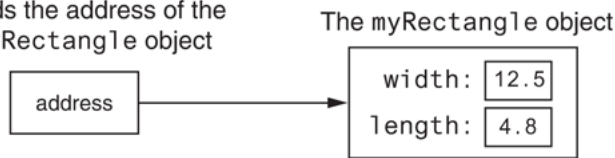
The `rectPtr` pointer can then be used to call member functions by using the `->` operator. The following statements show examples:

```
rectPtr->setWidth(12.5);
rectPtr->setLength(4.8);
```

The first statement calls the `setWidth` member function, passing 12.5 as an argument. Because `rectPtr` points to the `myRectangle` object, this will cause 12.5 to be stored in the `myRectangle` object's `width` variable. The second statement calls the `setLength` member function, passing 4.8 as an argument. This will cause 4.8 to be stored in the `myRectangle` object's `length` variable. [Figure 13-11](#) shows the state of the `myRectangle` object after these statements have executed.

**Figure 13-11** State of the `myRectangle` object

The `rectPtr` pointer variable holds the address of the `myRectangle` object



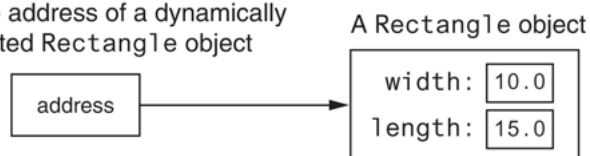
Class object pointers can be used to dynamically allocate objects. The following code shows an example:

```
1 // Define a Rectangle pointer.
2 Rectangle *rectPtr = nullptr;
3
4 // Dynamically allocate a Rectangle object.
5 rectPtr = new Rectangle;
6
7 // Store values in the object's width and length.
8 rectPtr->setWidth(10.0);
9 rectPtr->setLength(15.0);
10
11 // Delete the object from memory.
12 delete rectPtr;
13 rectPtr = nullptr;
```

Line 2 defines `rectPtr` as a `Rectangle` pointer. Line 5 uses the `new` operator to dynamically allocate a `Rectangle` object and assign its address to `rectPtr`. Lines 8 and 9 store values in the dynamically allocated object's `width` and `length` variables. [Figure 13-12](#) shows the state of the dynamically allocated object after these statements have executed.

**Figure 13-12** `rectPtr` points to a dynamically allocated `Rectangle` object

The `rectPtr` pointer variable holds the address of a dynamically allocated `Rectangle` object



Line 12 deletes the object from memory, and line 13 stores the address 0 in `rectPtr`. Recall from [Chapter 9](#) that this prevents code from inadvertently using the pointer to access the area of memory that has been freed. It also prevents errors from occurring if `delete` is accidentally called on the pointer again.

**Program 13-3** is a modification of **Program 13-2**. In this program, `kitchen`, `bedroom`, and `den` are `Rectangle` pointers. They are used to dynamically allocate `Rectangle` objects. The output is the same as **Program 13-2**.

## Program 13-3

```
1 // This program creates three instances of the Rectangle class.
2 #include <iostream>
3 using namespace std;
4
5 // Rectangle class declaration.
6     Lines 6 through 62 have been left out.
7
8
9
10
11
12
13
14
15
16
17
18
19
20
21
22
23
24
25
26
27
28
29
30
31
32
33
34
35
36
37
38
39
40
41
42
43
44
45
46
47
48
49
50
51
52
53
54
55
56
57
58
59
60
61
62
63
64 //*****
65 // Function main *
66 //*****
67
68 int main()
69 {
70     double number;           // To hold a number
71     double totalArea;       // The total area
72     Rectangle *kitchen = nullptr; // To point to kitchen dimensions
73     Rectangle *bedroom = nullptr; // To point to bedroom dimensions
74     Rectangle *den = nullptr; // To point to den dimensions
75
76     // Dynamically allocate the objects.
77     kitchen = new Rectangle;
78     bedroom = new Rectangle;
79     den = new Rectangle;
80
81     // Get the kitchen dimensions.
82     cout << "What is the kitchen's length? ";
83     cin >> number;           // Get the length
84     kitchen->setLength(number); // Store in kitchen object
85     cout << "What is the kitchen's width? ";
86     cin >> number;           // Get the width
87     kitchen->setWidth(number); // Store in kitchen object
88
89     // Get the bedroom dimensions.
90     cout << "What is the bedroom's length? ";
91     cin >> number;           // Get the length
92     bedroom->setLength(number); // Store in bedroom object
93     cout << "What is the bedroom's width? ";
```

```
94     cin >> number;                // Get the width
95     bedroom->setWidth(number);     // Store in bedroom object
96
97     // Get the den dimensions.
98     cout << "What is the den's length? ";
99     cin >> number;                // Get the length
100    den->setLength(number);         // Store in den object
101    cout << "What is the den's width? ";
102    cin >> number;                // Get the width
103    den->setWidth(number);         // Store in den object
104
105    // Calculate the total area of the three rooms.
106    totalArea = kitchen->getArea() + bedroom->getArea() +
107                den->getArea();
108
109    // Display the total area of the three rooms.
110    cout << "The total area of the three rooms is "
111            << totalArea << endl;
112
113    // Delete the objects from memory.
114    delete kitchen;
115    delete bedroom;
116    delete den;
117    kitchen = nullptr;           // Make kitchen a null pointer.
118    bedroom = nullptr;           // Make bedroom a null pointer.
119    den = nullptr;               // Make den a null pointer.
120
121    return 0;
122 }
```



# Using Smart Pointers to Allocate Objects

**11** [Chapter 9](#) discussed the smart pointer data type `unique_ptr`, which was introduced in C++ 11. Recall from [Chapter 9](#) that you can use a `unique_ptr` to dynamically allocate memory, and not worry about deleting the memory when you are finished using it. A `unique_ptr` automatically deletes a chunk of dynamically allocated memory when the memory is no longer being used. This helps to prevent memory leaks from occurring.

To use the `unique_ptr` data type, you must `#include` the `<memory>` header file with the following directive:

```
#include <memory>
```

Here is an example of the syntax for defining a `unique_ptr` that points to a dynamically allocated `Rectangle` object:

```
unique_ptr<Rectangle> rectanglePtr(new Rectangle);
```

This statement defines a `unique_ptr` named `rectanglePtr` that points to a dynamically allocated `Rectangle` object. Here are some details about the statement:

- The notation `<Rectangle>` that appears immediately after `unique_ptr` indicates that the pointer can point to a `Rectangle`.
- The name of the pointer is `rectanglePtr`.
- The expression `new Rectangle` that appears inside the parentheses allocates a chunk of memory to hold a `Rectangle`. The address of the chunk of memory will be assigned to the `rectanglePtr` pointer.

Once you have defined a `unique_ptr`, you can use it in the same way as a regular pointer. This is demonstrated in [Program 13-4](#). This is a revised version of [Program 13-3](#), modified to use `unique_ptr`s instead of regular pointers. The output is the same as [Programs 13-2](#) and [13-3](#).

## Program 13-4

```
1 // This program uses smart pointers to allocate three
2 // instances of the Rectangle class.
3 #include <iostream>
4 #include <memory>
5 using namespace std;
6
7 // Rectangle class declaration.
8 Lines 8 through 64 have been left out.
9
10
11
12
13
14
15
16
17
18
19
20
21
22
23
24
25
26
27
28
29
30
31
32
33
34
35
36
37
38
39
40
41
42
43
44
45
46
47
48
49
50
51
52
53
54
55
56
57
58
59
60
61
62
63
64
65
66 /** *****
67 // Function main *****
68 /** *****
69
70 int main()
71 {
72     double number; // To hold a number
73     double totalArea; // The total area
74
75     // Dynamically allocate the objects.
76     unique_ptr<Rectangle> kitchen(new Rectangle);
77     unique_ptr<Rectangle> bedroom(new Rectangle);
78     unique_ptr<Rectangle> den(new Rectangle);
79
80     // Get the kitchen dimensions.
81     cout << "What is the kitchen's length? ";
82     cin >> number; // Get the length
83     kitchen->setLength(number); // Store in kitchen object
84     cout << "What is the kitchen's width? ";
85     cin >> number; // Get the width
86     kitchen->setWidth(number); // Store in kitchen object
87
88     // Get the bedroom dimensions.
89     cout << "What is the bedroom's length? ";
90     cin >> number; // Get the length
91     bedroom->setLength(number); // Store in bedroom object
92     cout << "What is the bedroom's width? ";
93     cin >> number; // Get the width
```

```

94     bedroom->setWidth(number);           // Store in bedroom object
95
96     // Get the den dimensions.
97     cout << "What is the den's length? ";
98     cin >> number;                       // Get the length
99     den->setLength(number);             // Store in den object
100    cout << "What is the den's width? ";
101    cin >> number;                       // Get the width
102    den->setWidth(number);              // Store in den object
103
104    // Calculate the total area of the three rooms.
105    totalArea = kitchen->getArea() + bedroom->getArea() +
106                den->getArea();
107
108    // Display the total area of the three rooms.
109    cout << "The total area of the three rooms is "
110         << totalArea << endl;
111
112    return 0;
113 }

```

In line 4, we have a `#include` directive for the `<memory>` header file. Lines 76 through 78 define three `unique_ptr`s, named `kitchen`, `bedroom`, and `den`. Each of these points to a dynamically allocated `Rectangle`. Notice there are no `delete` statements at the end of the `main` function to free the dynamically allocated memory. It is unnecessary to delete the dynamically allocated `Rectangle` objects because the smart pointer will automatically delete them as the function comes to an end.

## Checkpoint

13.1 True or False: You must declare all private members of a class before the public members.

13.2 Assume `RetailItem` is the name of a class, and the class has a `void` member function named `setPrice`, which accepts a `double` argument. Which of the following shows the correct use of the scope resolution operator in the member function definition?

- A. `RetailItem::void setPrice(double p)`
- B. `void RetailItem::setPrice(double p)`

13.3 An object's private member variables are accessed from outside the object by which of the following?

- A. public member functions
- B. any function
- C. the dot operator
- D. the scope resolution operator

13.4 Assume `RetailItem` is the name of a class, and the class has a `void` member function named `setPrice`, which accepts a `double` argument. If `soap` is an instance of the `RetailItem` class, which of the following statements properly uses the `soap` object to call the `setPrice` member function?

- A. `RetailItem::setPrice(1.49);`
- B. `soap::setPrice(1.49);`
- C. `soap.setPrice(1.49);`
- D. `soap:setPrice(1.49);`

13.5 Complete the following code skeleton to declare a class named `Date`. The class should contain variables and functions to store and retrieve a date in the form 4/2/2018.

```
class Date
{
    private:
    public:
}
```

## 13.4 Why Have Private Members?

### Concept:

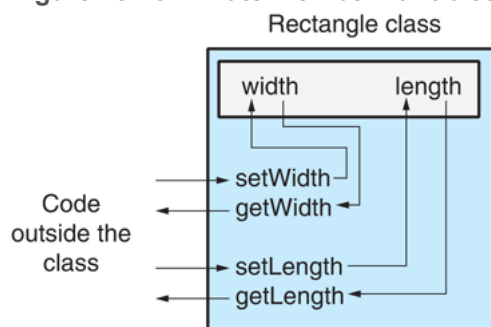
In object-oriented programming, an object should protect its important data by making it private and providing a public interface to access that data.

You might be questioning the rationale behind making the member variables in the `Rectangle` class private. You might also be questioning why member functions were defined for such simple tasks as setting variables and getting their contents. After all, if the member variables were declared as `public`, the member functions wouldn't be needed.

As mentioned earlier in this chapter, classes usually have variables and functions that are meant only to be used internally. They are not intended to be accessed by statements outside the class. This protects critical data from being accidentally modified or used in a way that might adversely affect the state of the object. When a member variable is declared as `private`, the only way for an application to store values in the variable is through a public member function. Likewise, the only way for an application to retrieve the contents of a private member variable is through a public member function. In essence, the public members become an interface to the object. They are the only members that may be accessed by any application that uses the object.

In the `Rectangle` class, the `width` and `length` member variables hold critical data. Therefore they are declared as `private`, and an interface is constructed with public member functions. If a program creates a `Rectangle` object, the program must use the `setWidth` and `getWidth` member functions to access the object's `width` member. To access the object's `length` member, the program must use the `setLength` and `getLength` member functions. This idea is illustrated in [Figure 13-13](#).

**Figure 13-13 Private member variables may be accessed only by member functions**



The public member functions can be written to filter out invalid data. For example, look at the following version of the `setWidth` member function:

```
void Rectangle::setWidth(double w)
{
    if (w >= 0)
        width = w;
    else
    {
        cout << "Invalid width\n";
        exit(EXIT_FAILURE);
    }
}
```

Notice this version of the function doesn't just assign the parameter value to the `width` variable. It first tests the parameter to make sure it is 0 or greater. If a negative number was passed to the function, an error message is displayed, then the standard library function `exit` is called to abort the program. The `setLength` function could be written in a similar way:

```
void Rectangle::setLength(double len)
{
    if (len >= 0)
        length = len;
    else
    {
        cout << "Invalid length\n";
        exit(EXIT_FAILURE);
    }
}
```

The point being made here is that mutator functions can do much more than simply store values in attributes. They can also validate those values to ensure that only acceptable data is stored in the object's attributes. Keep in mind, however, that calling the `exit` function, as we have done in these examples, is not the best way to deal with invalid data. In reality, you would not design a class to abort the entire program just because invalid data were passed to a mutator function. In [Chapter 15](#), we will discuss exceptions, which provide a much better way for classes to handle errors. Until we discuss exceptions, however, we will keep our code simple by using only rudimentary data validation techniques.

## 13.5 Focus on Software Engineering: Separating Class Specification from Implementation

### Concept:

Usually class declarations are stored in their own header files. Member function definitions are stored in their own .cpp files.

In the programs we've looked at so far, the class declaration, member function definitions, and application program are all stored in one file. A more conventional way of designing C++ programs is to store class declarations and member function definitions in their own separate files. Typically, program components are stored in the following fashion:

- Class declarations are stored in their own header files. A header file that contains a class declaration is called a *class specification* file. The name of the class specification file is usually the same as the name of the class, with a .h extension. For example, the `Rectangle` class would be declared in the file `Rectangle.h`.
- The member function definitions for a class are stored in a separate `.cpp` file called the *class implementation* file. The file usually has the same name as the class, with the .cpp extension. For example, the `Rectangle` class's member functions would be defined in the file `Rectangle.cpp`.
- Any program that uses the class should `#include` the class's header file. The class's .cpp file (which contains the member function definitions) should be compiled and linked with the `main` program. This process can be automated with a `project` or `make` utility. Integrated development environments such as Visual Studio also provide the means to create the multi-file projects.

Let's see how we could rewrite [Program 13-1](#) using this design approach. First, the `Rectangle` class declaration would be stored in the following `Rectangle.h` file. (This file can be found in the Student Source Code Folder [Chapter 13](#)\Rectangle Version 1.)

## Contents of `Rectangle.h` (Version 1)

```
1 // Specification file for the Rectangle class.
2 #ifndef RECTANGLE_H
3 #define RECTANGLE_H
4
5 // Rectangle class declaration.
6
7 class Rectangle
8 {
9     private:
10         double width;
11         double length;
12     public:
13         void setWidth(double);
14         void setLength(double);
15         double getWidth() const;
16         double getLength() const;
17         double getArea() const;
18 };
19
20 #endif
```

This is the specification file for the `Rectangle` class. It contains only the declaration of the `Rectangle` class. It does not contain any member function definitions. When we write other programs that use the `Rectangle` class, we can have an `#include` directive that includes this file. That way, we won't have to write the class declaration in every program that uses the `Rectangle` class.

This file also introduces two new preprocessor directives: `#ifndef` and `#endif`. The `#ifndef` directive that appears in line 2 is called an *include guard*. It prevents the header file from accidentally being included more than once. When your main program file has an `#include` directive for a header file, there is always the possibility that the header file will have an `#include` directive for a second header file. If your main program file also has an `#include` directive for the second header file, then the preprocessor will include the second header file twice. Unless an include guard has been written into the second header file, an error will occur because the compiler will process the declarations in the second header file twice. Let's see how an include guard works.



The word `ifndef` stands for “if not defined.” It is used to determine whether a specific constant has not been defined with a `#define` directive. When the `Rectangle.h` file is being compiled, the `ifndef` directive checks for the existence of a constant named `RECTANGLE_H`. If the constant has not been defined, it is immediately defined in line 3, and the rest of the file is included. If the constant has been defined, it means the file has already been included. In that case, everything between the `ifndef` and `endif` directives is skipped. This is illustrated in [Figure 13-14](#).

**Figure 13-14** How an include guard works

```
#ifndef RECTANGLE_H
#define RECTANGLE_H
class Rectangle
{
    // Member declarations
    // appear here.
};
#endif
```

This directive tells the preprocessor to see if a constant named `RECTANGLE_H` has *not* been previously created with a `#define` directive.

If the `RECTANGLE_H` constant has *not* been defined, these lines are included in the program. Otherwise, these lines are not included in the program.

```
#ifndef RECTANGLE_H
#define RECTANGLE_H
class Rectangle
{
    // Member declarations
    // appear here.
};
#endif
```

The first included line defines the `RECTANGLE_H` constant. If this file is included again, the include guard will skip its contents.

Next, we need an implementation file that contains the class’s member function definitions. The implementation file for the `Rectangle` class is `Rectangle.cpp`. (This file can be found in the Student Source Code Folder [Chapter 13](#) \Rectangle Version 1.)

## Contents of `Rectangle.cpp` (Version 1)

```
1 // Implementation file for the Rectangle class.
2 #include "Rectangle.h" // Needed for the Rectangle class
3 #include <iostream> // Needed for cout
4 #include <cstdlib> // Needed for the exit function
5 using namespace std;
6
7 //*****
8 // setWidth sets the value of the member variable width. *
9 //*****
10
11 void Rectangle::setWidth(double w)
12 {
13     if (w >= 0)
14         width = w;
15     else
16     {
17         cout << "Invalid width\n";
18         exit(EXIT_FAILURE);
19     }
20 }
21
22 //*****
23 // setLength sets the value of the member variable length. *
24 //*****
25
26 void Rectangle::setLength(double len)
27 {
28     if (len >= 0)
29         length = len;
30     else
31     {
32         cout << "Invalid length\n";
33         exit(EXIT_FAILURE);
34     }
35 }
36
37 //*****
```

```

38 // getWidth returns the value in the member variable width. *
39 //*****
40
41 double Rectangle::getWidth() const
42 {
43     return width;
44 }
45
46 //*****
47 // getLength returns the value in the member variable length. *
48 //*****
49
50 double Rectangle::getLength() const
51 {
52     return length;
53 }
54
55 //*****
56 // getArea returns the product of width times length. *
57 //*****
58
59 double Rectangle::getArea() const
60 {
61     return width * length;
62 }

```

Look at line 2, which has the following `#include` directive:

```
#include "Rectangle.h"
```

This directive includes the `Rectangle.h` file, which contains the `Rectangle` class declaration. Notice the name of the header file is enclosed in double-quote characters ( " ") instead of angled brackets (< >). When you are including a C++ system header file, such as `iostream`, you enclose the name of the file in angled brackets. This indicates the file is located in the compiler's *include file directory*. The include file directory is the directory or folder where all of the standard C++ header files are located. When you are including a header file that you have written, such as a class specification file, you enclose the name of the file in double-quote marks. This indicates the file is located in the current project directory.

Any file that uses the `Rectangle` class must have an `#include` directive for the `Rectangle.h` file. We need to include `Rectangle.h` in the class specification file because the functions in this file belong to the `Rectangle` class. Before the compiler can process a function with `Rectangle::` in its name, it must have already processed the `Rectangle` class declaration.

Now that we have the `Rectangle` class stored in its own specification and implementation files, we can see how to use them in a program. [Program 13-5](#) shows a modified version of [Program 13-1](#). This version of the program does not contain the `Rectangle` class declaration, or the definitions of any of the class's member functions. Instead, it is designed to be compiled and linked with the class specification and implementation files. (This file can be found in the Student Source Code Folder [Chapter 13](#)\Rectangle Version 1.)

## Program 13-5

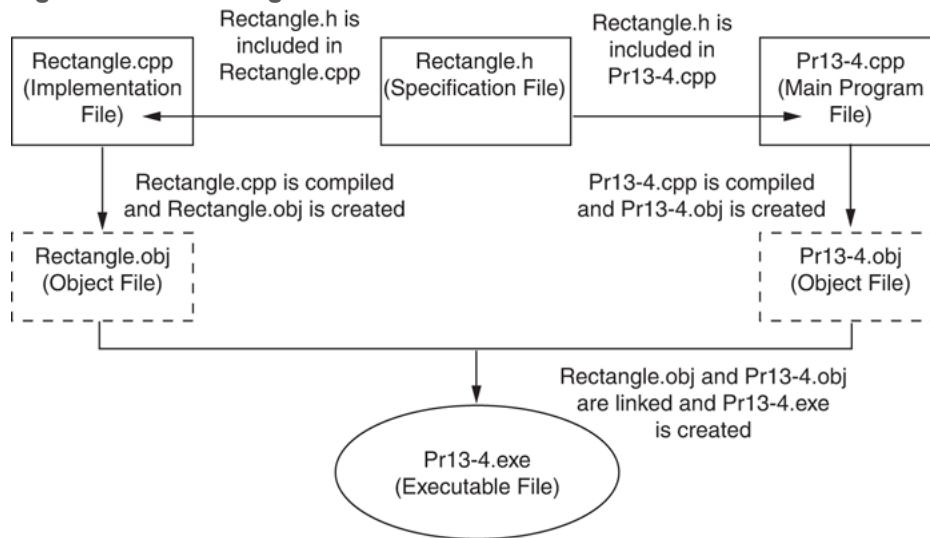
```
1 // This program uses the Rectangle class, which is declared in
2 // the Rectangle.h file. The member Rectangle class's member
3 // functions are defined in the Rectangle.cpp file. This program
4 // should be compiled with those files in a project.
5 #include <iostream>
6 #include "Rectangle.h" // Needed for Rectangle class
7 using namespace std;
8
9 int main()
10 {
11     Rectangle box; // Define an instance of the Rectangle class
12     double rectWidth; // Local variable for width
13     double rectLength; // Local variable for length
14
15     // Get the rectangle's width and length from the user.
16     cout << "This program will calculate the area of a\n";
17     cout << "rectangle. What is the width? ";
18     cin >> rectWidth;
19     cout << "What is the length? ";
20     cin >> rectLength;
21
22     // Store the width and length of the rectangle
23     // in the box object.
24     box.setWidth(rectWidth);
25     box.setLength(rectLength);
26
27     // Display the rectangle's data.
28     cout << "Here is the rectangle's data:\n";
29     cout << "Width: " << box.getWidth() << endl;
30     cout << "Length: " << box.getLength() << endl;
31     cout << "Area: " << box.getArea() << endl;
32     return 0;
33 }
```

Notice [Program 13-5](#) has an `#include` directive for the `Rectangle.h` file in line 6. This causes the declaration for the `Rectangle` class to be included in the file. To create an executable program from this file, the following steps must be taken:

- The implementation file, `Rectangle.cpp`, must be compiled. `Rectangle.cpp` is not a complete program, so you cannot create an executable file from it alone. Instead, you compile `Rectangle.cpp` to an object file that contains the compiled code for the `Rectangle` class. This file would typically be named `Rectangle.obj`.
- The main program file, `Pr13-4.cpp`, must be compiled. This file is not a complete program either because it does not contain any of the implementation code for the `Rectangle` class. So, you compile this file to an object file such as `Pr13-4.obj`.
- The object files, `Pr13-4.obj` and `Rectangle.obj`, are linked together to create an executable file, which would be named something like `Pr13-4.exe`.

This process is illustrated in [Figure 13-15](#).

**Figure 13-15 Creating an executable file**



The exact details on how these steps take place are different for each C++ development system. Fortunately, most systems perform all of these steps automatically for you. For example, in Microsoft Visual Studio you create a project, then you simply add all of the files to the project. When you compile the project, the steps are taken care of for you and an executable file is generated.

Separating a class into a specification file and an implementation file provides a great deal of flexibility. First, if you wish to give your class to another programmer, you don't have to share all of your source code with that programmer. You can give him or her the specification file and the compiled object file for the class's implementation. The other programmer simply inserts the necessary `#include` directive into his or her program, compiles it, and links it with your class's object file. This prevents the other

programmer, who might not know all the details of your code, from making changes that will introduce bugs.

Separating a class into specification and implementation files also makes things easier when the class's member functions must be modified. It is only necessary to modify the implementation file and recompile it to a new object file. Programs that use the class don't have to be completely recompiled, just linked with the new object file.

## 13.6 Inline Member Functions

### Concept:

When the body of a member function is written inside a class declaration, it is declared inline.

When the body of a member function is small, it is usually more convenient to place the function's definition, instead of its prototype, in the class declaration. For example, in the `Rectangle` class the member functions `getWidth`, `getLength`, and `getArea` each have only one statement. The `Rectangle` class could be revised as shown in the following listing. (This file can be found in the Student Source Code Folder [Chapter 13](#) \Rectangle Version 2.)



## Contents of `Rectangle.h` (Version 2)

```
1 // Specification file for the Rectangle class
2 // This version uses some inline member
  functions.
3 #ifndef RECTANGLE_H
4 #define RECTANGLE_H
5
6 class Rectangle
7 {
8     private:
9         double width;
10        double length;
11    public:
12        void setWidth(double);
13        void setLength(double);
14
15        double getWidth() const
16            { return width; }
17
18        double getLength() const
19            { return length; }
20
21        double getArea() const
22            { return width * length; }
```

```
23     };  
24 #endif
```

When a member function is defined in the declaration of a class, it is called an *inline function*. Notice because the function definitions are part of the class, there is no need to use the scope resolution operator and class name in the function header.

Notice the `getWidth`, `getLength`, and `getArea` functions are declared inline, but the `setWidth` and `setLength` functions are not. They are still defined outside the class declaration. The following listing shows the implementation file for the revised `Rectangle` class. (This file can be found in the Student Source Code Folder **Chapter 13** \Rectangle Version 2.)

## Contents of `Rectangle.cpp` (Version 2)

```
1 // Implementation file for the Rectangle
class.
2 // In this version of the class, the getWidth,
getWidth,
3 // and getArea functions are written inline in
Rectangle.h.
4 #include "Rectangle.h" // Needed for the
Rectangle class
5 #include <iostream> // Needed for cout
6 #include <cstdlib> // Needed for the
exit function
7 using namespace std;
8
9
//*****
*****
10 // setWidth sets the value of the member
variable width. *
11
//*****
*****
12
13 void Rectangle::setWidth(double w)
```

```
14 {
15     if (w >= 0)
16         width = w;
17     else
18     {
19         cout << "Invalid width\n";
20         exit(EXIT_FAILURE);
21     }
22 }
23
24
25 //*****
26
27 // setLength sets the value of the member
28 // variable length. *
29
30 //*****
31
32 void Rectangle::setLength(double len)
33 {
34     if (len >= 0)
35         length = len;
36     else
37     {
38         cout << "Invalid length\n";
39         exit(EXIT_FAILURE);
40     }
41 }
```

```
36     }
```

```
37 }
```

# Inline Functions and Performance

A lot goes on “behind the scenes” each time a function is called. A number of special items, such as the function’s return address in the program and the values of arguments, are stored in a section of memory called the *stack*. In addition, local variables are created and a location is reserved for the function’s return value. All this overhead, which sets the stage for a function call, takes precious CPU time. Although the time needed is minuscule, it can add up if a function is called many times, as in a loop.

Inline functions are compiled differently than other functions. In the executable code, inline functions aren’t “called” in the conventional sense. In a process known as *inline expansion*, the compiler replaces the call to an inline function with the code of the function itself. This means the overhead needed for a conventional function call isn’t necessary for an inline function and can result in improved performance.\* Because the inline function’s code can appear multiple times in the executable program, however, the size of the program can increase.†

\* Because inline functions cause code to increase in size, they can decrease performance on systems that use paging.

† Writing a function inline is a request to the compiler. The compiler will ignore the request if inline expansion is not possible or practical.



## Checkpoint

13.6 Why would you declare a class's member variables `private`?

13.7 When a class's member variables are declared `private`, how does code outside the class store values in, or retrieve values from, the member variables?

13.8 What is a class specification file? What is a class implementation file?

13.9 What is the purpose of an include guard?

13.10 Assume the following class components exist in a program:

`BasePay` class declaration

`BasePay` member function definitions

`Overtime` class declaration

`Overtime` member function definitions

In what files would you store each of these components?

13.11 What is an inline member function?

## 13.7 Constructors

### **Concept:**

A constructor is a member function that is automatically called when a class object is created.


A constructor is a member function that has the same name as the class. It is automatically called when the object is created in memory, or instantiated. It is helpful to think of constructors as initialization routines. They are very useful for initializing member variables or performing other setup operations.

To illustrate how constructors work, look at the following `Demo` class:



```
class Demo
{
    public:
    Demo(); // Constructor
};

Demo::Demo ()
{
    cout << "Welcome to the constructor!\n";
}
```

The class `Demo` only has one member: a function also named `Demo`. This function is the constructor. When an instance of this class is defined, the function `Demo` is automatically called. This is illustrated in [Program 13-6](#) .

## Program 13-6

```
1 // This program demonstrates a constructor.
2 #include <iostream>
3 using namespace std;
4
5 // Demo class declaration.
6
7 class Demo
8 {
9 public:
10     Demo(); // Constructor
11 };
12
13 Demo::Demo ()
14 {
15     cout << "Welcome to the constructor!\n";
16 }
17
18 //*****
19 // Function main. *
20 //*****
21
22 int main()
23 {
```

```
24     Demo demoObject; // Define a Demo object;
25
26     cout << "This program demonstrates an
object\n";
27     cout << "with a constructor.\n";
28     return 0;
29 }
```


## Program Output

```
Welcome to the constructor!
This program demonstrates an object
with a constructor.
```

Notice the constructor's function header looks different than that of a regular member function. There is no return type—not even `void`. This is because constructors are not executed by explicit function calls and cannot return a value. The function header of a constructor's external definition takes the following form:

```
ClassName::ClassName(ParameterList)
```

In the general format, *ClassName* is the name of the class, and *ParameterList* is an optional list of parameter variable declarations.

In **Program 13-6** , `demoObject`'s constructor executes automatically when the object is defined. Because the object is defined before the `cout` statements in function `main`, the constructor displays its message first. Suppose we had defined the `Demo` object between two `cout` statements, as shown here:

```
cout << "This is displayed before the object is created.\n";  
Demo demoObject;    // Define a Demo object.  
cout << "\nThis is displayed after the object is created.\n";
```

This code would produce the following output:

```
This is displayed before the object is created.  
Welcome to the constructor!  
This is displayed after the object is created.
```

This simple `Demo` example illustrates when a constructor executes. More importantly, you should understand why a class should have a constructor. A constructor's purpose is to initialize an object's attributes. Because the constructor executes as soon as the object is created, it can initialize the object's data members to valid values

before those members are used by other code. It is a good practice to always write a constructor for every class.

For example, the `Rectangle` class we looked at earlier could benefit from having a constructor. A program could define a `Rectangle` object then use that object to call the `getArea` function before any values were stored in `width` and `length`. Because the `width` and `length` member variables are not initialized, the function would return garbage. The following code shows a better version of the `Rectangle` class, equipped with a constructor. The constructor initializes both `width` and `length` to 0.0. (These files can be found in the Student Source Code Folder [Chapter 13](#) \Rectangle Version 3.)

## Contents of `Rectangle.h` (Version 3)

```
1 // Specification file for the Rectangle class
2 // This version has a constructor.
3 #ifndef RECTANGLE_H
4 #define RECTANGLE_H
5
6 class Rectangle
7 {
8     private:
9         double width;
10        double length;
11    public:
12        Rectangle(); //
13
14    Constructor
15
16        void setWidth(double);
17        void setLength(double);
18
19        double getWidth() const
20        { return width; }
21
22        double getLength() const
23        { return length; }
24
25        double getArea() const
```

```
23         { return width * length; }  
24     };  
25 #endif
```

## Contents of `Rectangle.cpp` (Version 3)

```
1 // Implementation file for the Rectangle
class.
2 // This version has a constructor.
3 #include "Rectangle.h" // Needed for the
Rectangle class
4 #include <iostream> // Needed for cout
5 #include <cstdlib> // Needed for the exit
function
6 using namespace std;
7
8
//*****
*****
9 // The constructor initializes width and
length to 0.0. *
10
//*****
*****
11
12 Rectangle::Rectangle()
13 {
14     width = 0.0;
15     length = 0.0;
```



```
16 }
17
18
//*****
*****
19 // setWidth sets the value of the member
variable width. *
20
//*****
*****
21
22 void Rectangle::setWidth(double w)
23 {
24     if (w >= 0)
25         width = w;
26     else
27     {
28         cout << "Invalid width\n";
29         exit(EXIT_FAILURE);
30     }
31 }
32
33
//*****
*****
34 // setLength sets the value of the member
variable length. *
```

```

35
//*****
*****
36
37 void Rectangle::setLength(double len)
38 {
39     if (len >= 0)
40         length = len;
41     else
42     {
43         cout << "Invalid length\n";
44         exit(EXIT_FAILURE);
45     }
46 }

```

**Program 13-7**  demonstrates this new version of the class. It creates a `Rectangle` object then displays the values returned by the `getWidth`, `getLength`, and `getArea` member functions. (This file can be found in the Student Source Code Folder **Chapter 13**  \Rectangle Version 3.)

## Program 13-7

```
1 // This program uses the Rectangle class's
  constructor.
2 #include <iostream>
3 #include "Rectangle.h" // Needed for Rectangle
  class
4 using namespace std;
5
6 int main()
7 {
8     Rectangle box; // Define an instance of
  the Rectangle class
9
10    // Display the rectangle's data.
11    cout << "Here is the rectangle's data:\n";
12    cout << "Width: " << box.getWidth() <<
  endl;
13    cout << "Length: " << box.getLength() <<
  endl;
14    cout << "Area: " << box.getArea() << endl;
15    return 0;
16 }
```

## Program Output

```
Here is the rectangle's data:
```

```
Width: 0
```

```
Length: 0
```

```
Area: 0
```

# Using Member Initialization Lists

The constructor in the previously shown `Rectangle` class uses assignment statements to store initial values in the `width` and `length` member variables, as shown here:

```
Rectangle::Rectangle()  
{  
    width = 0.0;  
    length = 0.0;  
}
```

You can use an alternative technique, known as a *member initialization list*, to initialize the members of a class. Here is an example of the `Rectangle` class's constructor, rewritten to use a member initialization list instead of assignment statements:

```
Rectangle::Rectangle() :  
    width(0.0), length(0.0)  
{  
}
```

In this version of the constructor, a colon appears at the end of the function header, followed by the member initialization list. The

member initialization list shows each member variable's name, followed by an initial value enclosed in parentheses. The member variables are separated by commas in the list. This version of the constructor initializes the `width` and `length` member variables with the value 0.0.

Notice in this version of the constructor, the constructor's body is empty. Because the initialization of the member variables is handled by the initialization list, there is nothing to do in the body of the constructor.

Many programmers prefer to use member initialization lists instead of assignment statements inside of the body of the constructor because, in some situations, it allows the compiler to generate more efficient code.



**Note:**

When a constructor has a member initialization list, the initializations take place before any statements in the body of the constructor execute.

## 11 In-Place Member Initialization

Prior to C++ 11, you could not initialize a member variable in its declaration statement. You had to use the class constructor to either assign initial values to the class's members or use a member initialization list in the constructor. In C++ 11, you can initialize a member variable in its declaration statement, just as you can with a regular variable. This is known as *in-place initialization*. Here is an example:

```
class Rectangle
{
private:
    double width = 0.0;
    double length = 0.0;
public:
    Public member functions appear here...
};
```

# The Default Constructor

All of the examples we have looked at in this section demonstrate default constructors. A *default constructor* is a constructor that takes no arguments. Like regular functions, constructors may accept arguments, have default arguments, be declared inline, and be overloaded. We will see examples of these as we progress through the chapter.

If you write a class with no constructor whatsoever, when the class is compiled, C++ will automatically write a default constructor that does nothing. For example, the first version of the `Rectangle` class had no constructor; so, when the class was compiled, C++ generated the following constructor:

```
Rectangle::Rectangle()  
{ }
```



# Default Constructors and Dynamically Allocated Objects

Earlier we discussed how class objects may be dynamically allocated in memory. For example, assume the following pointer is defined in a program:

```
Rectangle *rectPtr = nullptr;
```

This statement defines `rectPtr` as a `Rectangle` pointer. It can hold the address of any `Rectangle` object. But because this statement does not actually create a `Rectangle` object, the constructor does not execute. Suppose we use the pointer in a statement that dynamically allocates a `Rectangle` object, as shown in the following code:


```
rectPtr = new Rectangle;
```

This statement creates a `Rectangle` object. When the `Rectangle` object is created by the `new` operator, its default constructor is automatically executed.

# 13.8 Passing Arguments to Constructors

## Concept:

A constructor can have parameters and can accept arguments when an object is created.

Constructors may accept arguments in the same way as other functions. When a class has a constructor that accepts arguments, you can pass initialization values to the constructor when you create an object. For example, the following code shows yet another version of the `Rectangle` class. This version has a constructor that accepts arguments for the rectangle's width and length. (These files can be found in the Student Source Code Folder **Chapter 13**  `Rectangle Version 4.`)

## Contents of `Rectangle.h` (Version 4)

```
1 // Specification file for the Rectangle class
2 // This version has a constructor.
3 #ifndef RECTANGLE_H
4 #define RECTANGLE_H
5
6 class Rectangle
7 {
8     private:
9         double width;
10        double length;
11    public:
12        Rectangle(double, double); //
13
14    Constructor
15
16        void setWidth(double);
17        void setLength(double);
18
19        double getWidth() const
20            { return width; }
21
22        double getLength() const
23            { return length; }
24
25        double getArea() const
```

```
23         { return width * length; }  
24     };  
25 #endif
```

## Contents of `Rectangle.cpp` (Version 4)

```
1 // Implementation file for the Rectangle
class.
2 // This version has a constructor that accepts
arguments.
3 #include "Rectangle.h" // Needed for the
Rectangle class
4 #include <iostream> // Needed for cout
5 #include <cstdlib> // Needed for the
exit function
6 using namespace std;
7
8
//*****
*****
9 // The constructor accepts arguments for width
and length. *
10
//*****
*****
11
12 Rectangle::Rectangle(double w, double len)
13 {
14     width = w;
```

```
15     length = len;
16 }
17
18
//*****
*****
19 // setWidth sets the value of the member
variable width. *
20
//*****
*****
21
22 void Rectangle::setWidth(double w)
23 {
24     if (w >= 0)
25         width = w;
26     else
27     {
28         cout << "Invalid width\n";
29         exit(EXIT_FAILURE);
30     }
31 }
32
33
//*****
*****
34 // setLength sets the value of the member
```

```

variable length. *
35
//*****
*****
36
37 void Rectangle::setLength(double len)
38 {
39     if (len >= 0)
40         length = len;
41     else
42     {
43         cout << "Invalid length\n";
44         exit(EXIT_FAILURE);
45     }
46 }

```

The constructor, which appears in lines 12 through 16 of Rectangle.cpp, accepts two arguments, which are passed into the `w` and `len` parameters. The parameters are assigned to the `width` and `length` member variables. Because the constructor is automatically called when a `Rectangle` object is created, the arguments are passed to the constructor as part of the object definition. Here is an example:

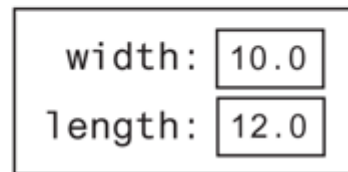
```
Rectangle box(10.0, 12.0);
```

This statement defines `box` as an instance of the `Rectangle` class. The constructor is called with the value 10.0 passed into the `w` parameter and 12.0 passed into the `len` parameter. As a result, the object's `width` member variable will be assigned 10.0 and the `length` member variable will be assigned 12.0. This is illustrated in [Figure 13-16](#).

### Figure 13-16 Arguments passed to a constructor

The box object is initialized with `width` set to 10.0 and `length` set to 12.0

```
Rectangle box(10.0, 12.0);
```



[Program 13-8](#) demonstrates the class. (This file can be found in the Student Source Code Folder [Chapter 13](#)\Rectangle Version 4.)



## Program 13-8


```
1 // This program calls the Rectangle class
  constructor.
2 #include <iostream>
3 #include <iomanip>
4 #include "Rectangle.h"
5 using namespace std;
6
7 int main()
8 {
9     double houseWidth, // To hold the room
width
10     houseLength; // To hold the room
length
11
12     // Get the width of the house.
13     cout << "In feet, how wide is your house?
";
14     cin >> houseWidth;
15
16     // Get the length of the house.
17     cout << "In feet, how long is your house?
";
18     cin >> houseLength;
```

```
19
20     // Create a Rectangle object.
21     Rectangle house(houseWidth, houseLength);
22
23     // Display the house's width, length, and
area.
24     cout << setprecision(2) << fixed;
25     cout << "The house is " <<
house.getWidth()
26         << " feet wide.\n";
27     cout << "The house is " <<
house.getLength()
28         << " feet long.\n";
29     cout << "The house is " << house.getArea()
30         << " square feet in area.\n";
31     return 0;
32 }
```

**Program Output with Example Input Shown in Bold**

```
In feet, how wide is your house? 30 Enter
In feet, how long is your house? 60 Enter
The house is 30.00 feet wide.
The house is 60.00 feet long.
The house is 1800.00 square feet in area.
```



The statement in line 21 creates a `Rectangle` object, passing the values in `houseWidth` and `houseLength` as arguments.

The following code shows another example: the `Sale` class. This class might be used in a retail environment where sales transactions take place. An object of the `Sale` class represents the sale of an item. (This file can be found in the Student Source Code Folder **Chapter 13**  `Sale Version 1.`)

## Contents of `Sale.h` (Version 1)

```
1 // Specification file for the Sale class.
2 #ifndef SALE_H
3 #define SALE_H
4
5 class Sale
6 {
7     private:
8         double itemCost;    // Cost of the item
9         double taxRate;    // Sales tax rate
10    public:
11        Sale(double cost, double rate)
12            { itemCost = cost;
13              taxRate = rate; }
14
15        double getItemCost() const
16            { return itemCost; }
17
18        double getTaxRate() const
19            { return taxRate; }
20
21        double getTax() const
22            { return (itemCost * taxRate); }
23
```

```
24     double getTotal() const
25     { return (itemCost + getTax()); }
26 };
27 #endif
```

The `itemCost` member variable, declared in line 8, holds the selling price of the item. The `taxRate` member variable, declared in line 9, holds the sales tax rate. The constructor appears in lines 11 and 13. Notice the constructor is written inline. It accepts two arguments, the item cost and the sales tax rate. These arguments are used to initialize the `itemCost` and `taxRate` member variables. The `getItemCost` member function, in lines 15 and 16, returns the value in `itemCost`, and the `getTaxRate` member function, in lines 18 and 19, returns the value in `taxRate`. The `getTax` member function, in lines 21 and 22, calculates and returns the amount of sales tax for the purchase. The `getTotal` member function, in lines 24 and 25, calculates and returns the total of the sale. The total is the item cost plus the sales tax. **Program 13-9**  demonstrates the class. (This file can be found in the Student Source Code Folder **Chapter 13**  \Sale Version 1.)

## Program 13-9

```
1 // This program demonstrates passing an
argument to a constructor.
2 #include <iostream>
3 #include <iomanip>
4 #include "Sale.h"
5 using namespace std;
6
7 int main()
8 {
9     const double TAX_RATE = 0.06; // 6 percent
sales tax rate
10    double cost; // To hold
the item cost
11
12    // Get the cost of the item.
13    cout << "Enter the cost of the item: ";
14    cin >> cost;
15
16    // Create a Sale object for this
transaction.
17    Sale itemSale(cost, TAX_RATE);
18
19    // Set numeric output formatting.
```

```
20     cout << fixed << showpoint <<
setprecision(2);
21
22     // Display the sales tax and total.
23     cout << "The amount of sales tax is $"
24           << itemSale.getTax() << endl;
25     cout << "The total of the sale is $";
26     cout << itemSale.getTotal() << endl;
27     return 0;
28 }
```

### Program Output with Example Input Shown in Bold

```
Enter the cost of the item: 10.00 Enter
The amount of sales tax is $0.60
The total of the sale is $10.60
```

In the example run of the program, the user enters 10.00 as the cost of the item. This value is stored in the local variable `cost`. In line 17, the `itemSale` object is created. The values of the `cost` variable and the `TAX_RATE` constant are passed as arguments to the constructor. As a result, the object's `cost` member variable is initialized with the

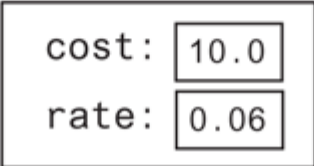
value 10.0, and the `rate` member variable is initialized with the value 0.06. This is illustrated in [Figure 13-17](#).

**Figure 13-17 Arguments passed to the constructor**

The local variable `cost` is set to 10.0.      The constant `TAX_RATE` is set to 0.06.

```
Sale itemSale(cost, TAX_RATE);
```

The `itemSale` object is initialized with the `cost` member set to 10.0 and the `rate` member set to 0.06





# Using Default Arguments with Constructors

Like other functions, constructors may have default arguments. Recall from [Chapter 6](#) that default arguments are passed to parameters automatically if no argument is provided in the function call. The default value is listed in the parameter list of the function's declaration or the function header. The following code shows a modified version of the `Sale` class. This version's constructor uses a default argument for the tax rate. (This file can be found in the Student Source Code Folder [Chapter 13](#)\Sale Version 2.)

## Contents of `sale.h` (Version 2)

```
1 // This version of the Sale class uses a
default argument
2 // in the constructor.
3 #ifndef SALE_H
4 #define SALE_H
5
6 class Sale
7 {
8     private:
9         double itemCost; // Cost of the item
10        double taxRate; // Sales tax rate
11    public:
12        Sale(double cost, double rate = 0.05)
13            { itemCost = cost;
14              taxRate = rate; }
15
16        double getItemCost() const
17            { return itemCost; }
18
19        double getTaxRate() const
20            { return taxRate; }
21
22        double getTax() const
```

```
23     { return (itemCost * taxRate); }
24
25     double getTotal() const
26     { return (itemCost + getTax()); }
27 };
28 #endif
```

If an object of this `Sale` class is defined with only one argument (for the `cost` parameter) passed to the constructor, the default argument 0.05 will be provided for the `rate` parameter. This is demonstrated in [Program 13-10](#). (This file can be found in the Student Source Code Folder [Chapter 13](#)\Sale Version 2.)

## Program 13-10

```
1 // This program uses a constructor's default
argument.
2 #include <iostream>
3 #include <iomanip>
4 #include "Sale.h"
5 using namespace std;
6
7 int main()
8 {
9     double cost; // To hold the item cost
10
11     // Get the cost of the item.
12     cout << "Enter the cost of the item: ";
13     cin >> cost;
14
15     // Create a Sale object for this
transaction.
16     // Specify the item cost, but use the
default
17     // tax rate of 5 percent.
18     Sale itemSale(cost);
19
20     // Set numeric output formatting.
```

```
21     cout << fixed << showpoint <<
setprecision(2);
22
23     // Display the sales tax and total.
24     cout << "The amount of sales tax is $"
25         << itemSale.getTax() << endl;
26     cout << "The total of the sale is $";
27     cout << itemSale.getTotal() << endl;
28     return 0;
29 }
```

### Program Output with Example Input Shown in Bold

```
Enter the cost of the item: 10.00 Enter
The amount of sales tax is $0.50
The total of the sale is $10.50
```

# More about the Default Constructor

It was mentioned earlier that when a constructor doesn't accept arguments, it is known as the default constructor. If a constructor has default arguments for all its parameters, it can be called with no explicit arguments. It then becomes the default constructor. For example, suppose the constructor for the `Sale` class had been written as the following:

```
Sale(double cost = 0.0, double rate = 0.05)
{
    itemCost = cost;
    taxRate = rate;
}
```

This constructor has default arguments for each of its parameters. As a result, the constructor can be called with no arguments, as shown here:

```
Sale itemSale;
```

This statement defines a `Sale` object. No arguments were passed to the constructor, so the default arguments for both parameters are

used. Because this constructor can be called with no arguments, it is the default constructor.

## *Classes with No Default Constructor*

When all of a class's constructors require arguments, then the class does not have a default constructor. In such a case, you must pass the required arguments to the constructor when creating an object. Otherwise, a compiler error will result.


## 13.9 Destructors

### Concept:

A destructor is a member function that is automatically called when an object is destroyed.

Destructors are member functions with the same name as the class, preceded by a tilde character (~). For example, the destructor for the `Rectangle` class would be named `~Rectangle`.

Destructors are automatically called when an object is destroyed. In the same way that constructors set things up when an object is created, destructors perform shutdown procedures when the object goes out of existence. For example, a common use of destructors is to free memory that was dynamically allocated by the class object.

**Program 13-11**  shows a simple class with a constructor and a destructor. It illustrates when, during the program's execution, each is called.



## Program 13-11

```
1 // This program demonstrates a destructor.
2 #include <iostream>
3 using namespace std;
4
5 class Demo
6 {
7 public:
8     Demo(); // Constructor
9     ~Demo(); // Destructor
10 };
11
12 Demo::Demo()
13 {
14     cout << "Welcome to the constructor!\n";
15 }
16
17 Demo::~~Demo()
18 {
19     cout << "The destructor is now
20 running.\n";
21 }
22
```

```

//*****
23 // Function main.
*
24
//*****
25
26 int main()
27 {
28     Demo demoObject; // Define a demo object;
29
30     cout << "This program demonstrates an
object\n";
31     cout << "with a constructor and
destructor.\n";
32     return 0;
33 }

```

## Program Output

```

Welcome to the constructor!
This program demonstrates an object
with a constructor and destructor.
The destructor is now running.

```

The following code shows a more realistic example of a class with a destructor. The `ContactInfo` class holds the following data about a contact:

- The contact's name
- The contact's phone number

The constructor accepts arguments for both items. The name and phone number are passed as a pointer to a C-string. Rather than storing the name and phone number in a `char` array with a fixed size, the constructor gets the length of the C-string and dynamically allocates just enough memory to hold it. The destructor frees the allocated memory when the object is destroyed. (This file can be found in the Student Source Code Folder [Chapter 13](#) \ContactInfo Version 1.)

## Contents of `ContactInfo.h` (Version 1)



```
1 // Specification file for the Contact class.
2 #ifndef CONTACTINFO_H
3 #define CONTACTINFO_H
4 #include <cstring> // Needed for strlen and
strcpy
5
6 // ContactInfo class declaration.
7 class ContactInfo
8 {
9 private:
10     char *name; // The name
11     char *phone; // The phone number
12 public:
13     // Constructor
14     ContactInfo(char *n, char *p)
15     { // Allocate just enough memory for the
name and phone number.
16         name = new char[strlen(n) + 1];
17         phone = new char[strlen(p) + 1];
18
19         // Copy the name and phone number to
the allocated memory.
20         strcpy(name, n);
```

```

21     strcpy(phone, p); }
22
23     // Destructor
24     ~ContactInfo()
25     { delete [] name;
26       delete [] phone; }
27
28     const char *getName() const
29     { return name; }
30
31     const char *getPhoneNumber() const
32     { return phone; }
33 };
34 #endif

```

Notice the return type of the `getName` and `getPhoneNumber` functions in lines 28 through 32 is `const char *`. This means each function returns a pointer to a constant `char`. This is a security measure. It prevents any code that calls the functions from changing the string that the pointer points to.

**Program 13-12**  demonstrates the class. (This file can be found in the Student Source Code Folder **Chapter 13**  \ContactInfo Version 1.)

## Program 13-12

```
1 // This program demonstrates a class with a
  destructor.
2 #include <iostream>
3 #include "ContactInfo.h"
4 using namespace std;
5
6 int main()
7 {
8     // Define a ContactInfo object with the
  following data:
9     // Name: Kristen Lee, Phone Number: 555-
  2021
10    ContactInfo entry("Kristen Lee", "555-
  2021");
11
12    // Display the object's data.
13    cout << "Name: " << entry.getName() <<
  endl;
14    cout << "Phone Number: " <<
  entry.getPhoneNumber() << endl;
15    return 0;
16 }
```

## Program Output

```
Name: Kristen Lee  
Phone Number: 555-2021
```

In addition to the fact that destructors are automatically called when an object is destroyed, the following points should be mentioned:

- Like constructors, destructors have no return type.
- Destructors cannot accept arguments, so they never have a parameter list.

# Destructors and Dynamically Allocated Class Objects

If a class object has been dynamically allocated by the `new` operator, its memory should be released when the object is no longer needed. For example, in the following code `objectPtr` is a pointer to a dynamically allocated `ContactInfo` class object:

```
// Define a ContactInfo pointer.  
ContactInfo *objectPtr = nullptr;  
  
// Dynamically create a ContactInfo object.  
objectPtr = new ContactInfo("Kristen Lee", "555-2021");
```

The following statement shows the `delete` operator being used to destroy the dynamically created object:

```
delete objectPtr;
```

When the object pointed to by `objectPtr` is destroyed, its destructor is automatically called.





## **Note:**

If you have used a smart pointer such as `unique_ptr` (introduced in C++ 11) to allocate an object, the object will automatically be deleted, and its destructor will be called when the smart pointer goes out of scope. It is not necessary to use `delete` with a `unique_ptr`.



## Checkpoint

13.12 Briefly describe the purpose of a constructor.

13.13 Briefly describe the purpose of a destructor.

13.14 A member function that is never declared with a return data type, but that may have arguments is which of the following?

- A. The constructor
- B. The destructor
- C. Both the constructor and the destructor
- D. Neither the constructor nor the destructor

13.15 A member function that is never declared with a return data type and can never have arguments is which of the following?

- A. The constructor
- B. The destructor
- C. Both the constructor and the destructor
- D. Neither the constructor nor the destructor

13.16 Destructor function names always start with

\_\_\_\_\_.

- A. A number
- B. Tilde character ( ~ )
- C. A data type name
- D. None of the above

13.17 A constructor that requires no arguments is called

\_\_\_\_\_.

- A. A default constructor
- B. An overloaded constructor
- C. A null constructor
- D. None of the above

13.18 True or False: Constructors are never declared with a return data type.

13.19 True or False: Destructors are never declared with a return type.

13.20 True or False: Destructors may take any number of arguments.

## 13.10 Overloading Constructors

### Concept:

A class can have more than one constructor.

Recall from [Chapter 6](#) that when two or more functions share the same name, the function is said to be overloaded. Multiple functions with the same name may exist in a C++ program, as long as their parameter lists are different.

A class's member functions may be overloaded, including the constructor. One constructor might take an `int` argument, for example, while another constructor takes a `double`. There could even be a third constructor taking two integers. As long as each constructor takes a different list of parameters, the compiler can tell them apart. For example, the `string` class has several overloaded constructors. The following statement creates a `string` object with no arguments passed to the constructor:

```
string str;
```

This executes the `string` class's default constructor, which stores an empty string in the object. Another way to create a `string` object is to pass a string literal as an argument to the constructor, as shown here:

```
string str("Hello");
```

This executes an overloaded constructor, which stores the string "Hello" in the object.

Let's look at an example of how you can create overloaded constructors. The `InventoryItem` class holds the following data about an item that is stored in inventory:

- Item's description (a `string` object)
- Item's cost (a `double`)
- Number of units in inventory (an `int`)

The following code shows the class. To simplify the code, all the member functions are written inline. (This file can be found in the Student Source Code Folder [Chapter 13](#) \InventoryItem.)

## Contents of `InventoryItem.h`

```
1 // This class has overloaded constructors.
2 #ifndef INVENTORYITEM_H
3 #define INVENTORYITEM_H
4 #include <string>
5 using namespace std;
6
7 class InventoryItem
8 {
9     private:
10         string description; // The item
11         double cost; // The item cost
12         int units; // Number of units on
13         hand
14     public:
15         // Constructor #1 (default constructor)
16         InventoryItem()
17         { // Initialize description, cost, and
18         units.
19             description = "";
20             cost = 0.0;
21             units = 0; }
```

```
21 // Constructor #2
22 InventoryItem(string desc)
23 { // Assign the value to description.
24     description = desc;
25
26     // Initialize cost and units.
27     cost = 0.0;
28     units = 0; }
29
30 // Constructor #3
31 InventoryItem(string desc, double c, int u)
32 { // Assign values to description, cost,
33 and units.
34     description = desc;
35     cost = c;
36     units = u; }
37
38 // Mutator functions
39 void setDescription(string d)
40 { description = d; }
41
42 void setCost(double c)
43 { cost = c; }
44
45 void setUnits(int u)
46 { units = u; }
```



```
47     // Accessor functions
48     string getDescription() const
49     { return description; }
50
51     double getCost() const
52     { return cost; }
53
54     int getUnits() const
55     { return units; }
56 };
57 #endif
```

The first constructor appears in lines 15 through 19. It takes no arguments, so it is the default constructor. It initializes the `description` variable to an empty string. The `cost` and `units` variables are initialized to 0.

The second constructor appears in lines 22 through 28. This constructor accepts only one argument, the item description. The `cost` and `units` variables are initialized to 0.

The third constructor appears in lines 31 through 35. This constructor accepts arguments for the description, cost, and units.



The mutator functions set values for `description`, `cost`, and `units`. **Program 13-13**  demonstrates the class. (This file can be found in the Student Source Code Folder **Chapter 13**  `InventoryItem`.)

## Program 13-13

```
1 // This program demonstrates a class with
overloaded constructors.
2 #include <iostream>
3 #include <iomanip>
4 #include "InventoryItem.h"
5
6 int main()
7 {
8     // Create an InventoryItem object with
constructor #1.
9     InventoryItem item1;
10    item1.setDescription("Hammer"); // Set
the description
11    item1.setCost(6.95); // Set
the cost
12    item1.setUnits(12); // Set
the units
13
14    // Create an InventoryItem object with
constructor #2.
15    InventoryItem item2("Pliers");
16
17    // Create an InventoryItem object with
```

```
constructor #3.  
18     InventoryItem item3("Wrench", 8.75, 20);  
19  
20     cout << "The following items are in  
inventory:\n";  
21     cout << setprecision(2) << fixed <<  
showpoint;  
22  
23     // Display the data for item 1.  
24     cout << "Description: " <<  
item1.getDescription() << endl;  
25     cout << "Cost: $" << item1.getCost() <<  
endl;  
26     cout << "Units on Hand: " <<  
item1.getUnits() << endl << endl;  
27  
28     // Display the data for item 2.  
29     cout << "Description: " <<  
item2.getDescription() << endl;  
30     cout << "Cost: $" << item2.getCost() <<  
endl;  
31     cout << "Units on Hand: " <<  
item2.getUnits() << endl << endl;  
32  
33     // Display the data for item 3.  
34     cout << "Description: " <<  
item3.getDescription() << endl;
```

```
35     cout << "Cost: $" << item3.getCost() <<
endl;
36     cout << "Units on Hand: " <<
item3.getUnits() << endl;
37     return 0;
38 }
```

## Program Output

```
The following items are in inventory:
Description: Hammer
Cost: $6.95
Units on Hand: 12

Description: Pliers
Cost: $0.00
Units on Hand: 0

Description: Wrench
Cost: $8.75
Units on Hand: 20
```

# 11 Constructor Delegation

Often, a class will have multiple constructors that perform a similar set of steps, or some of the same steps. For example, look at the following `Contact` class:

```

class Contact
{
private:
    string name;
    string email;
    string phone;
public:
    // Constructor #1 (default)
    Contact()
    { name = "";
      email = "";
      phone = "";
    }
    // Constructor #2
    Contact(string n, string e, string p)
    { name = n;
      email = e;
      phone = p;
    }
    Other member functions follow...
};

```

In this class, both constructors perform a similar operation: They assign values to the `name`, `email`, and `phone` member variables. The default constructor assigns empty strings to the members, and

the parameterized constructor assigns specified values to the members.

In C++ 11, it is possible for one constructor to call another constructor in the same class. This is known as *constructor delegation*. The following code shows how we can use constructor delegation in the `Contact` class:

```
class Contact
{
private:
    string name;
    string email;
    string phone;
public:
    // Constructor #1 (default)
    Contact() : Contact("", "", "")
    { }

    // Constructor #2
    Contact(string n, string e, string p)
    { name = n;
      email = e;
      phone = p;
    }

    Other member functions follow...
};
```

In this version of the class, the default constructor calls constructor #2. Notice that a colon appears at the end of the default constructor's header, followed by a call to constructor #2 with three empty strings listed inside the parentheses. Any time the `Contact` class's default constructor is called, it calls constructor #2, passing the empty strings as arguments. As a result, the empty strings are assigned to the object's `name`, `email`, and `phone` member variables.



# Only One Default Constructor and One Destructor

When an object is defined without an argument list for its constructor, the compiler automatically calls the default constructor. For this reason, a class may have only one default constructor. If there were more than one constructor that could be called without an argument, the compiler would not know which one to call by default.

Remember, a constructor whose parameters all have a default argument is considered a default constructor. It would be an error to create a constructor that accepts no parameters along with another constructor that has default arguments for all its parameters. In such a case, the compiler would not be able to resolve which constructor to execute.

Classes may also only have one destructor. Because destructors take no arguments, the compiler has no way to distinguish different destructors.

# Other Overloaded Member Functions

Member functions other than constructors can also be overloaded. This can be useful because sometimes you need several different ways to perform the same operation. For example, in the `InventoryItem` class we could have overloaded the `setCost` function as shown here:

```
void setCost(double c)
{
    cost = c;
}

void setCost(string c)
{
    cost = stod(c);
}
```

The first version of the function accepts a `double` argument and assigns it to `cost`. The second version of the function accepts a `string` object. This could be used where you have the cost of the item stored in a `string` object. The function calls the `stod` function to convert the string to a `double` and assigns its value to `cost`.

## 13.11 Private Member Functions

### Concept:

A private member function may only be called from a function that is a member of the same class.

Sometimes a class will contain one or more member functions that are necessary for internal processing, but should not be called by code outside the class. For example, a class might have a member function that performs a calculation only when a value is stored in a particular member variable and should not be performed at any other time. That function should not be directly accessible by code outside the class because it might get called at the wrong time. In this case, the member function should be declared `private`. When a member function is declared `private`, it may only be called internally.

For example, consider the following version of the `ContactInfo` class. (This file can be found in the Student Source Code Folder [Chapter 13](#) `ContactInfo Version 2.`)

## Contents of `ContactInfo.h` (Version 2)

```
1 // Contact class specification file (version
2)
3 #ifndef CONTACTINFO_H
4 #define CONTACTINFO_H
5
6 // ContactInfo class declaration.
7 class ContactInfo
8 {
9     private:
10         char *name; // The contact's name
11         char *phone; // The contact's phone number
12
13         // Private member function: initName
14         // This function initializes the name
15         // attribute.
16         void initName(char *n)
17         { name = new char[strlen(n) + 1];
18           strcpy(name, n); }
19
20         // Private member function: initPhone
21         // This function initializes the phone
```

```
attribute.  
21     void initPhone(char *p)  
22     { phone = new char[strlen(p) + 1];  
23       strcpy(phone, p); }  
24 public:  
25     // Constructor  
26     ContactInfo(char *n, char *p)  
27     { // Initialize the name attribute.  
28       initName(n);  
29  
30       // Initialize the phone attribute.  
31       initPhone(n); }  
32  
33     // Destructor  
34     ~ContactInfo()  
35     { delete [] name;  
36       delete [] phone; }  
37  
38     const char *getName() const  
39     { return name; }  
40  
41     const char *getPhoneNumber() const  
42     { return phone; }  
43 };  
44 #endif
```

## 13.12 Arrays of Objects

### Concept:

You may define and work with arrays of class objects.

As with any other data type in C++, you can define arrays of class objects. An array of `InventoryItem` objects could be created to represent a business's inventory records. Here is an example of such a definition:

```
const int ARRAY_SIZE = 40;  
InventoryItem inventory[ARRAY_SIZE];
```

This statement defines an array of 40 `InventoryItem` objects. The name of the array is `inventory`, and the default constructor is called for each object in the array.

If you wish to define an array of objects and call a constructor that requires arguments, you must specify the arguments for each object individually in an initializer list. Here is an example:

```
InventoryItem inventory[] = {"Hammer", "Wrench", "Pliers"};
```

The compiler treats each item in the initializer list as an argument for an array element's constructor. Recall that the second constructor in the `InventoryItem` class declaration takes the item description as an argument. So, this statement defines an array of three objects and calls that constructor for each object. The constructor for `inventory[0]` is called with "Hammer" as its argument, the constructor for `inventory[1]` is called with "Wrench" as its argument, and the constructor for `inventory[2]` is called with "Pliers" as its argument.



### **Warning!**

If the class does not have a default constructor you must provide an initializer for each object in the array.

If a constructor requires more than one argument, the initializer must take the form of a function call. For example, look at the following definition statement:

```
InventoryItem inventory[] = { InventoryItem("Hammer", 6.95,  
12),  
                                InventoryItem("Wrench", 8.75, 20),  
                                InventoryItem("Pliers", 3.75, 10)  
};
```

This statement calls the third constructor in the `InventoryItem` class declaration for each object in the `inventory` array.

It isn't necessary to call the same constructor for each object in an array. For example, look at the following statement:

```
InventoryItem inventory[] = { "Hammer",  
                                InventoryItem("Wrench", 8.75, 20),  
                                "Pliers" };
```

This statement calls the second constructor for `inventory[0]` and `inventory[2]`, and calls the third constructor for `inventory[1]`.

If you do not provide an initializer for all of the objects in an array, the default constructor will be called for each object that does not have an initializer. For example, the following statement defines an array of three objects, but only provides initializers for the first two. The default constructor is called for the third object.



```
const int SIZE = 3;

InventoryItem inventory [SIZE] = { "Hammer",
                                   InventoryItem("Wrench", 8.75,
20) };
```

In summary, if you use an initializer list for class object arrays, there are three things to remember:

- If there is no default constructor you must furnish an initializer for each object in the array.
- If there are fewer initializers in the list than objects in the array, the default constructor will be called for all the remaining objects.
- If a constructor requires more than one argument, the initializer takes the form of a constructor function call.

# Accessing Members of Objects in an Array

Objects in an array are accessed with subscripts, just like any other data type in an array. For example, to call the `setUnits` member function of `inventory[2]`, the following statement could be used:

```
inventory[2].setUnits(30);
```

This statement sets the `units` variable of `inventory[2]` to the value 30. [Program 13-14](#) shows an array of `InventoryItem` objects being used in a complete program. (This file is stored in the Student Source Code Folder [Chapter 13](#)\InventoryItem.)

## Program 13-14

```
1 // This program demonstrates an array of class
objects.
2 #include <iostream>
3 #include <iomanip>
4 #include "InventoryItem.h"
5 using namespace std;
6
7 int main()
8 {
9     const int NUM_ITEMS = 5;
10    InventoryItem inventory[NUM_ITEMS] = {
11        InventoryItem("Hammer",
12        6.95, 12),
13        InventoryItem("Wrench",
14        8.75, 20),
15        InventoryItem("Pliers",
16        3.75, 10),
17        InventoryItem("Ratchet",
18        7.95, 14),
19        InventoryItem("Screwdriver",
20        2.50, 22) };
21
22    cout << setw(14) <<"Inventory Item"
```

```
18         << setw(8) << "Cost" << setw(8)
19         << setw(16) << "Units on Hand\n";
20     cout << "-----
---\n";
21
22     for (int i = 0; i < NUM_ITEMS; i++)
23     {
24         cout << setw(14) <<
inventory[i].getDescription();
25         cout << setw(8) <<
inventory[i].getCost();
26         cout << setw(7) <<
inventory[i].getUnits() << endl;
27     }
28
29     return 0;
30 }
```

## Program Output

Inventory Item	Cost	Units on Hand
----------------	------	---------------

-----

Hammer	6.95	12
Wrench	8.75	20
Pliers	3.75	10
Ratchet	7.95	14
Screwdriver	2.5	22



### 13.21 What will the following program display on the screen?

```
#include <iostream>
using namespace std;
class Tank
{
private:
    int gallons;
public:
    Tank()
        { gallons = 50; }
    Tank(int gal)
        { gallons = gal; }
    int getGallons()
        { return gallons; }
};
int main()
{
    Tank storage[3] = { 10, 20 };
    for (int index = 0; index < 3; index++)
        cout << storage[index].getGallons() << endl;
    return 0;
}
```

### 13.22 What will the following program display on the screen?

```
#include <iostream>
using namespace std;

class Package
{
private:
    int value;
public:
    Package()
        { value = 7; cout << value << endl; }
    Package(int v)
        { value = v; cout << value << endl; }
    ~Package()
        { cout << value << endl; }
};

int main()
{
    Package obj1(4);
    Package obj2;
    Package obj3(2);
    return 0;
}
```

13.23 In your answer for Checkpoint 13.22, indicate for each line of output whether the line is displayed by constructor #1,

constructor #2, or the destructor.

13.24 Why would a member function be declared private?

13.25 Define an array of three `InventoryItem` objects.

13.26 Complete the following program so it defines an array of `Yard` objects. The program should use a loop to ask the user for the length and width of each `Yard`.

```
#include <iostream>
using namespace std;
class Yard
{
private:
    int length, width;
public:
    Yard()
        { length = 0; width = 0; }
    setLength(int len)
        { length = len; }
    setWidth(int w)
        { width = w; }
};
int main()
{
    // Finish this program
}
```




# 13.13 Focus on Problem Solving and Program Design: An OOP Case Study

You are a programmer for the Home Software Company. You have been assigned to develop a class that models the basic workings of a bank account. The class should perform the following tasks:

- Save the account balance.
- Save the number of transactions performed on the account.
- Allow deposits to be made to the account.
- Allow withdrawals to be taken from the account.
- Calculate interest for the period.
- Report the current account balance at any time.
- Report the current number of transactions at any time.

## Private Member Variables

**Table 13-4**  lists the private member variables needed by the class.

### Table 13-4 Private Member Variables

# Public Member Functions

**Table 13-5**  lists the public member functions needed by the class.

## Table 13-5 Public Member Functions

# The Class Declaration

The following listing shows the class declaration:

## Contents of `Account.h`

```
1 // Specification file for the Account class.
2 #ifndef ACCOUNT_H
3 #define ACCOUNT_H
4
5 class Account
6 {
7     private:
8         double balance;           // Account balance
9         double interestRate;     // Interest rate
10        for the period
11        double interest;         // Interest earned
12        for the period
13        int transactions;        // Number of
14        transactions
15    public:
16        Account(double iRate = 0.045, double bal =
17        0)
18        { balance = bal;
19          interestRate = iRate;
20          interest = 0;
21          transactions = 0; }
22
23        void setInterestRate(double iRate)
```

```
20     { interestRate = iRate; }
21
22     void makeDeposit(double amount)
23     { balance += amount; transactions++; }
24
25     void withdraw(double amount); // Defined in
Account.cpp
26
27     void calcInterest()
28     { interest = balance * interestRate;
balance += interest; }
29
30     double getInterestRate() const
31     { return interestRate; }
32
33     double getBalance() const
34     { return balance; }
35
36     double getInterest() const
37     { return interest; }
38
39     int getTransactions() const
40     { return transactions; }
41 };
42 #endif
```



# The `withdraw` Member Function

The only member function not written `inline` in the class declaration is `withdraw`. The purpose of that function is to subtract the amount of a withdrawal from the `balance` member. If the amount to be withdrawn is greater than the current balance, however, no withdrawal is made. The function returns true if the withdrawal is made, or false if there is not enough in the account.

## Contents of `Account.cpp`

```
1 // Implementation file for the Account class.
2 #include "Account.h"
3
4 bool Account::withdraw(double amount)
5 {
6     if (balance < amount)
7         return false; // Not enough in the
account
8     else
9     {
10         balance -= amount;
11         transactions++;
12         return true;
13     }
14 }
```




# The Class's Interface

The `balance`, `interestRate`, `interest`, and `transactions` member variables are private, so they are hidden from the world outside the class. The reason is that a programmer with direct access to these variables might unknowingly commit any of the following errors:

- A deposit or withdrawal might be made without the `transactions` member being incremented.
- A withdrawal might be made for more than is in the account. This will cause the `balance` member to have a negative value.
- The interest rate might be calculated and the `balance` member adjusted, but the amount of interest might not get recorded in the `interest` member.
- The wrong interest rate might be used.

Because of the potential for these errors, the class contains public member functions that ensure the proper steps are taken when the account is manipulated.

# Implementing the Class

**Program 13-15**  shows an implementation of the `Account` class. It presents a menu for displaying a savings account's balance, number of transactions, and interest earned. It also allows the user to deposit an amount into the account, make a withdrawal from the account, and calculate the interest earned for the current period.

## Program 13-15

```
1 // This program demonstrates the Account
class.
2 #include <iostream>
3 #include <cctype>
4 #include <iomanip>
5 #include "Account.h"
6 using namespace std;
7
8 // Function prototypes
9 void displayMenu();
10 void makeDeposit(Account &);
11 void withdraw(Account &);
12
13 int main()
14 {
15     Account savings; // Savings account
object
16     char choice; // Menu selection
17
18     // Set numeric output formatting.
19     cout << fixed << showpoint <<
setprecision(2);
20
```

```
21     do
22     {
23         // Display the menu and get a valid
selection.
24         displayMenu();
25         cin >> choice;
26         while (toupper(choice) < 'A' ||
toupper(choice) > 'G')
27         {
28             cout << "Please make a choice in
the range "
29                 << "of A through G:";
30             cin >> choice;
31         }
32
33         // Process the user's menu selection.
34         switch(choice)
35         {
36             case 'a':
37                 case 'A': cout << "The current
balance is $";
38                     cout << savings.getBalance()
<< endl;
39                     break;
40             case 'b':
41                 case 'B': cout << "There have been ";
42                     cout <<
```

```
savings.getTransactions()
43         << " transactions.\n";
44         break;
45     case 'c':
46         case 'C': cout << "Interest earned
for this period: $";
47         cout <<
savings.getInterest() << endl;
48         break;
49     case 'd':
50         case 'D': makeDeposit(savings);
51         break;
52     case 'e':
53         case 'E': withdraw(savings);
54         break;
55     case 'f':
56         case 'F': savings.calcInterest();
57         cout << "Interest
added.\n";
58     }
59     } while (toupper(choice) != 'G');
60
61     return 0;
62 }
63
64
//*****
```

```

*****
65 // Definition of function displayMenu. This
function *
66 // displays the user's menu on the screen.
*
67
//*****
*****
68
69 void displayMenu()
70 {
71     cout << "\n          MENU\n";
72     cout << "-----
-----\n";
73     cout << "A) Display the account
balance\n";
74     cout << "B) Display the number of
transactions\n";
75     cout << "C) Display interest earned for
this period\n";
76     cout << "D) Make a deposit\n";
77     cout << "E) Make a withdrawal\n";
78     cout << "F) Add interest for this
period\n";
79     cout << "G) Exit the program\n\n";
80     cout << "Enter your choice: ";
81 }

```

```
82
83
//*****
*****
84 // Definition of function makeDeposit. This
function accepts *
85 // a reference to an Account object. The user
is prompted for *
86 // the dollar amount of the deposit, and the
makeDeposit *
87 // member of the Account object is then
called. *
88
//*****
*****
89
90 void makeDeposit(Account &acct)
91 {
92     double dollars;
93
94     cout << "Enter the amount of the deposit:
";
95     cin >> dollars;
96     cin.ignore();
97     acct.makeDeposit(dollars);
98 }
99
```

```
100
//*****
*****
101 // Definition of function withdraw. This
function accepts *
102 // a reference to an Account object. The user
is prompted for *
103 // the dollar amount of the withdrawal, and
the withdraw *
104 // member of the Account object is then
called. *
105
//*****
*****
106
107 void withdraw(Account &acct)
108 {
109     double dollars;
110
111     cout << "Enter the amount of the
withdrawal: ";
112     cin >> dollars;
113     cin.ignore();
114     if (!acct.withdraw(dollars))
115         cout << "ERROR: Withdrawal amount
too large.\n\n";
116 }
```



## Program Output with Example Input Shown in Bold

MENU

---

- A) Display the account balance
- B) Display the number of transactions
- C) Display interest earned for this period
- D) Make a deposit
- E) Make a withdrawal
- F) Add interest for this period
- G) Exit the program

Enter your choice: **d** Enter

Enter the amount of the deposit: **500** Enter

MENU

---

- A) Display the account balance
- B) Display the number of transactions
- C) Display interest earned for this period
- D) Make a deposit
- E) Make a withdrawal
- F) Add interest for this period
- G) Exit the program

Enter your choice: **a** Enter

The current balance is \$500.00

MENU

- 
- A) Display the account balance
  - B) Display the number of transactions
  - C) Display interest earned for this period
  - D) Make a deposit
  - E) Make a withdrawal
  - F) Add interest for this period
  - G) Exit the program

Enter your choice: **e** Enter

Enter the amount of the withdrawal: **700**

Enter

ERROR: Withdrawal amount too large.

MENU

- 
- A) Display the account balance
  - B) Display the number of transactions
  - C) Display interest earned for this period
  - D) Make a deposit
  - E) Make a withdrawal
  - F) Add interest for this period
  - G) Exit the program

Enter your choice: **e** Enter

Enter the amount of the withdrawal: **200**

Enter

MENU

- 
- A) Display the account balance
  - B) Display the number of transactions
  - C) Display interest earned for this period
  - D) Make a deposit
  - E) Make a withdrawal
  - F) Add interest for this period
  - G) Exit the program

Enter your choice: **f** Enter  
Interest added.

MENU

- 
- A) Display the account balance
  - B) Display the number of transactions
  - C) Display interest earned for this period
  - D) Make a deposit
  - E) Make a withdrawal
  - F) Add interest for this period
  - G) Exit the program

Enter your choice: **a** Enter  
The current balance is \$313.50

MENU

# 13.14 Focus on Object-Oriented Programming: Simulating Dice with Objects

Dice traditionally have six sides, representing the values 1 to 6. Some games, however, use specialized dice that have a different number of sides. For example, the fantasy role-playing game *Dungeons and Dragons*® uses dice with four, six, eight, ten, twelve, and twenty sides.

Suppose you are writing a program that needs to roll simulated dice with various numbers of sides. A simple approach would be to write a `Die` class with a constructor that accepts the number of sides as an argument. The class would also have appropriate methods for rolling the die and getting the die's value. An example of such a class follows. (These files can be found in the Student Source Code Folder [Chapter 13](#) \Dice.)

## Contents of `Die.h`

```
1 // Specification file for the Die class
2 #ifndef DIE_H
3 #define DIE_H
4
5 class Die
6 {
7     private:
8         int sides; // Number of sides
9         int value; // The die's value
10
11     public:
12         Die(int = 6); // Constructor
13         void roll(); // Rolls the die
14         int getSides(); // Returns the number of
15 sides
16         int getValue(); // Returns the die's
17 value
18 };
19 #endif
```

## Contents of `Die.cpp`

```
1 // Implementation file for the Die class
2 #include <cstdlib> // For rand and srand
3 #include <ctime> // For the time function
4 #include "Die.h"
5 using namespace std;
6
7
8 //*****
9 // The constructor accepts an argument for the
10 number *
11 // of sides for the die, and performs a roll.
12 *
13 //*****
14
15 Die::Die(int numSides)
16 {
17 // Get the system time.
18 unsigned seed = time(0);
19
20 // Seed the random number generator.
21 srand(seed);
```

```

18
19     // Set the number of sides.
20     sides = numSides;
21
22     // Perform an initial roll.
23     roll();
24 }
25
26
//*****
*****
27 // The roll member function simulates the
rolling of *
28 // the die.
*
29
//*****
*****
30 void Die::roll()
31 {
32     // Constant for the minimum die value
33     const int MIN_VALUE = 1; // Minimum die
value
34
35     // Get a random value for the die.
36     value = (rand() % (sides - MIN_VALUE + 1)) +
MIN_VALUE;


```



```
37 }
38
39
//*****
*****
40 // The getSides member function returns the
number of *
41 // for this die.
*
42
//*****
*****
43 int Die::getSides()
44 {
45     return sides;
46 }
47
48
//*****
*****
49 // The getValue member function returns the
die's value. *
50
//*****
*****
51 int Die::getValue()
52 {
```

```
53     return value;  
54 }
```

Here is a synopsis of the class members:

The code in **Program 13-16**  demonstrates the class. It creates two instances of the `Die` class: one with six sides, and the other with twelve sides. It then simulates five rolls of the dice.

## Program 13-16

```
1 // This program simulates the rolling of dice.
2 #include <iostream>
3 #include "Die.h"
4 using namespace std;
5
6 int main()
7 {
8     const int DIE1_SIDES = 6;    // Number of
sides for die #1
9     const int DIE2_SIDES = 12;  // Number of
sides for die #2
10    const int MAX_ROLLS = 5;    // Number of
times to roll
11
12    // Create two instances of the Die class.
13    Die die1(DIE1_SIDES);
14    Die die2(DIE2_SIDES);
15
16    // Display the initial state of the dice.
17    cout << "This simulates the rolling of a "
18         << die1.getSides() << " sided die and
a "
19         << die2.getSides() << " sided
```

```
die.\n";
20
21     cout << "Initial value of the dice:\n";
22     cout << die1.getValue() << " "
23         << die2.getValue() << endl;
24
25     // Roll the dice five times.
26     cout << "Rolling the dice " << MAX_ROLLS
27         << " times.\n";
28     for (int count = 0; count < MAX_ROLLS;
count++)
29     {
30         // Roll the dice.
31         die1.roll();
32         die2.roll();
33
34         // Display the values of the dice.
35         cout << die1.getValue() << " "
36             << die2.getValue() << endl;
37     }
38     return 0;
39 }
```

## Program Output

```
This simulates the rolling of a 6 sided die  
and a 12 sided die.
```

```
Initial value of the dice:
```

```
1 7
```

```
Rolling the dice 5 times.
```

```
6 2
```

```
3 5
```

```
4 2
```

```
5 11
```

```
4 7
```

Let's take a closer look at the program:

## 13.15 Focus on Object-Oriented Design: The Unified Modeling Language (UML)

### Concept:

The Unified Modeling Language provides a standard method for graphically depicting an object-oriented system.

When designing a class, it is often helpful to draw a UML diagram. *UML* stands for *Unified Modeling Language*. The UML provides a set of standard diagrams for graphically depicting object-oriented systems. **Figure 13-18** shows the general layout of a UML diagram for a class. Notice the diagram is a box that is divided into three sections. The top section is where you write the name of the class. The middle section holds a list of the class's member variables. The bottom section holds a list of the class's member functions.

**Figure 13-18** General layout of a UML diagram



Earlier in this chapter, you studied a `Rectangle` class that could be used in a program that works with rectangles. The first version of the `Rectangle` class that you studied had the following member variables:

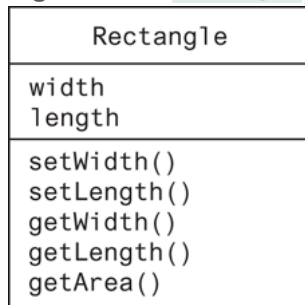
- `width`
- `length`

The class also had the following member functions:

- `setWidth`
- `setLength`
- `getWidth`
- `getLength`
- `getArea`

From this information alone we can construct a simple UML diagram for the class, as shown in [Figure 13-19](#).

**Figure 13-19** `Rectangle` class

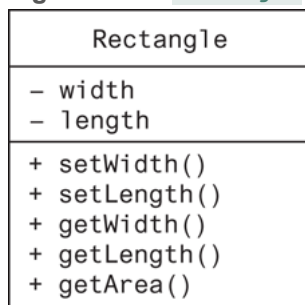


The UML diagram in [Figure 13-19](#) tells us the name of the class, the names of the member variables, and the names of the member functions. The UML diagram in [Figure 13-19](#) does not convey many of the class details, however, such as access specification, member variable data types, parameter data types, and function return types. The UML provides optional notation for these types of details.

## Showing Access Specification in UML Diagrams

The UML diagram in [Figure 13-19](#) lists all of the members of the `Rectangle` class, but does not indicate which members are private and which are public. In a UML diagram you may optionally place a `-` character before a member name to indicate that it is private, or a `+` character to indicate that it is public. [Figure 13-20](#) shows the UML diagram modified to include this notation.

**Figure 13-20** `Rectangle` class with access specification



# Data Type and Parameter Notation in UML Diagrams

The Unified Modeling Language also provides notation that you may use to indicate the data types of member variables, member functions, and parameters. To indicate the data type of a member variable, place a colon followed by the name of the data type after the name of the variable. For example, the `width` variable in the `Rectangle` class is a `double`. It could be listed as follows in the UML diagram:

```
- width : double
```



## Note:

In UML notation the variable name is listed first, then the data type. This is the opposite of C++ syntax, which requires the data type to appear first.

The return type of a member function can be listed in the same manner: After the function's name, place a colon followed by the return type. The `Rectangle` class's `getLength` function returns a `double`, so it could be listed as follows in the UML diagram:

```
+ getLength() : double
```

Parameter variables and their data types may be listed inside a member function's parentheses. For example, the `Rectangle` class's `setLength` function has a `double` parameter named `len`, so it could be listed as follows in the UML diagram:

```
+ setLength(len : double) : void
```

**Figure 13-21**  shows a UML diagram for the `Rectangle` class with parameter and data type notation.



Figure 13-21 `Rectangle` class with access specification and return types

Rectangle
- width : double - length : double
+ setWidth(w : double) : void + setLength(len : double) : void + getWidth() : double + getLength() : double + getArea() : double

## Showing Constructors and Destructors in a UML Diagram

There is more than one accepted way of showing a class constructor in a UML diagram. In this book, we will show a constructor just as any other function, except we will list no return type. For example, [Figure 13-22](#) shows a UML diagram for the `InventoryItem` class we looked at previously in this chapter.

Figure 13-22 `InventoryItem` class

InventoryItem
- description : string - cost : double - units : int
+ InventoryItem() : + InventoryItem(desc : string) : + InventoryItem(desc : string, c : double, u : int) : + setDescription(d : string) : void + setCost(c : double) : void + setUnits(u : int) : void + getDescription() : string + getCost() : double + getUnits() : int

## 13.16 Focus on Object-Oriented Design: Finding the Classes and Their Responsibilities

### **Concept:**

One of the first steps in creating an object-oriented application is determining the classes that are necessary and their responsibilities within the application.

So far, you have learned the basics of writing a class, creating an object from the class, and using the object to perform operations. This knowledge is necessary to create an object-oriented application, but it is not the first step in designing the application. The first step is to analyze the problem you are trying to solve and determine the classes you will need. In this section, we will discuss a simple technique for finding the classes in a problem and determining their responsibilities.

### Finding the Classes

When developing an object-oriented application, one of your first tasks is to identify the classes you will need to create. Typically, your goal is to identify the different types of real-world objects that are present in the problem, then create classes for those types of objects within your application.

Over the years, software professionals have developed numerous techniques for finding the classes in a given problem. One simple and popular technique involves the following steps:

1. Get a written description of the problem domain.
2. Identify all the nouns (including pronouns and noun phrases) in the description. Each of these is a potential class.
3. Refine the list to include only the classes that are relevant to the problem.

Let's take a closer look at each of these steps.

# Write a Description of the Problem Domain

The *problem domain* is the set of real-world objects, parties, and major events related to the problem. If you adequately understand the nature of the problem you are trying to solve, you can write a description of the problem domain yourself. If you do not thoroughly understand the nature of the problem, you should have an expert write the description for you.

For example, suppose we are programming an application that the manager of Joe's Automotive Shop will use to print service quotes for customers. Here is a description that an expert, perhaps Joe himself, might have written:

Joe's Automotive Shop services foreign cars, and specializes in servicing cars made by Mercedes, Porsche, and BMW. When a customer brings a car to the shop, the manager gets the customer's name, address, and telephone number. The manager then determines the make, model, and year of the car and gives the customer a service quote. The service quote shows the estimated parts charges, estimated labor charges, sales tax, and total estimated charges.

The problem domain description should include any of the following:

- Physical objects such as vehicles, machines, or products
- Any role played by a person, such as manager, employee, customer, teacher, student, and so on.
- The results of a business event, such as a customer order, or in this case, a service quote
- Recordkeeping items, such as customer histories and payroll records

# Identify All of the Nouns

The next step is to identify all of the nouns and noun phrases. (If the description contains pronouns, include them as well.) Here's another look at the previous problem domain description. This time, the nouns and noun phrases appear in bold.

**Joe's Automotive Shop** services **foreign cars**, and specializes in servicing **cars** made by **Mercedes**, **Porsche**, and **BMW**. When a **customer** brings a **car** to the **shop**, the **manager** gets the **customer's name**, **address**, and **telephone number**. The **manager** then determines the **make**, **model**, and **year** of the **car**, and gives the **customer** a **service quote**. The **service quote** shows the **estimated parts charges**, **estimated labor charges**, **sales tax**, and **total estimated charges**.

Notice some of the nouns are repeated. The following list shows all of the nouns without duplicating any of them:

address

BMW

car

cars

customer

estimated labor charges

estimated parts charges

foreign cars

Joe's Automotive Shop

make

manager

Mercedes

model

name

Porsche

sales tax

service quote

shop

telephone number

total estimated charges

year

# Refine the List of Nouns

The nouns that appear in the problem description are merely candidates to become classes. It might not be necessary to make classes for them all. The next step is to refine the list to include only the classes that are necessary to solve the particular problem at hand. We will look at the common reasons that a noun can be eliminated from the list of potential classes.

1. Some of the nouns really mean the same thing.

In this example, the following sets of nouns refer to the same thing:

- **cars** and **foreign cars**

These both refer to the general concept of a car.

- **Joe's Automotive Shop** and **shop**

Both of these refer to the company "Joe's Automotive Shop."

We can settle on a single class for each of these. In this example we will arbitrarily eliminate **foreign cars** from the list, and use the word **cars**. Likewise, we will eliminate **Joe's Automotive Shop** from the list and use the word **shop**. The updated list of potential classes is:

2. **Some nouns might represent items we do not need to be concerned with in order to solve the problem.**

A quick review of the problem description reminds us of what our application should do: print a service quote. In this example, we can eliminate two unnecessary classes from the list:

- We can cross **shop** off the list because our application only needs to be concerned with individual service quotes. It doesn't need to work with or determine any company-wide information. If the problem description asked us to keep a total of all the service quotes, then it would make sense to have a class for the shop.
- We will not need a class for the **manager** because the problem statement does not direct us to process any information about the manager. If there were multiple shop managers, and the problem description had asked us to record which manager generated each service quote, then it would make sense to have a class for the manager.

The updated list of potential classes at this point is:

3. **Some of the nouns might represent objects, not classes.**

We can eliminate Mercedes, Porsche, and BMW as classes because, in this example, they all represent specific cars and can be considered instances of a cars class. Also, we can eliminate the word car from the list. In the description, it refers to a specific car brought to the shop by a customer. Therefore, it would also represent an instance of a cars class. At this point the updated list of potential classes is:



### **Note:**

Some object-oriented designers take note of whether a noun is plural or singular. Sometimes a plural noun will indicate a class, and a singular noun will indicate an object.

4. Some of the nouns might represent simple values that can be stored in a variable, and do not require a class.

Remember, a class contains attributes and member functions. Attributes are related items that are stored within an object of the class, and define the object's state. Member functions are actions or behaviors that may be performed by an object of the class. If a noun represents a type of item that would not have any identifiable attributes or member functions, then it can probably be eliminated from the list. To help determine whether a noun represents an item that would have attributes and member functions, ask the following questions about it:

- Would you use a group of related values to represent the item's state?
- Are there any obvious actions to be performed by the item?

If the answers to both of these questions are no, then the noun probably represents a value that can be stored in a simple variable. If we apply this test to each of the nouns that remain in our list, we can conclude that the following are probably not classes: **address, estimated labor charges, estimated parts charges, make, model, name, sales tax, telephone number, total estimated charges, and year**. These are all simple string or numeric values that can be stored in variables. Here is the updated list of potential classes:

As you can see from the list, we have eliminated everything except cars, customer, and service quote. This means that in our application, we will need classes to represent cars, customers, and service quotes. Ultimately, we will write a `Car` class, a `Customer` class, and a `ServiceQuote` class.

# Identifying a Class's Responsibilities

Once the classes have been identified, the next task is to identify each class's responsibilities. A class's *responsibilities* are

- the things that the class is responsible for knowing.
- the actions that the class is responsible for doing.

When you have identified the things that a class is responsible for knowing, then you have identified the class's attributes. Likewise, when you have identified the actions that a class is responsible for doing, you have identified its member functions.

It is often helpful to ask the questions "In the context of this problem, what must the class know? What must the class do?" The first place to look for the answers is in the description of the problem domain. Many of the things a class must know and do will be mentioned. Some class responsibilities, however, might not be directly mentioned in the problem domain, so brainstorming is often required. Let's apply this methodology to the classes we previously identified from our problem domain.



## The `Customer` class

In the context of our problem domain, what must the `Customer` class know? The description directly mentions the following items, which are all attributes of a customer:

- the customer's name
- the customer's address
- the customer's telephone number

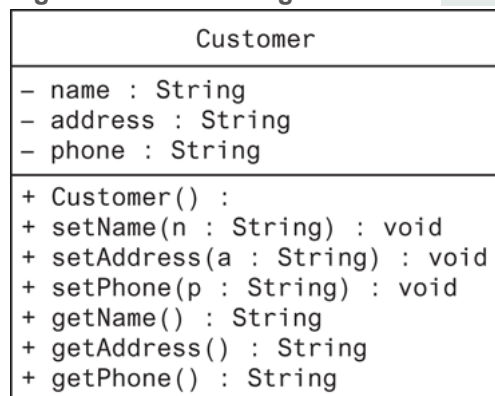
These are all values that can be represented as strings and stored in the class's member variables. The `Customer` class can potentially know many other things. One mistake that can be made at this point is to identify too many things that an object is responsible for knowing. In some applications, a `Customer` class might know the customer's e-mail address. This particular problem domain does not mention that the customer's e-mail address is used for any purpose, so we should not include it as a responsibility.

Now let's identify the class's member functions. In the context of our problem domain, what must the `Customer` class do? The only obvious actions are to

- create an object of the `Customer` class.
- set and get the customer's name.
- set and get the customer's address.
- set and get the customer's telephone number.

From this list, we can see that the `Customer` class will have a constructor, as well as accessor and mutator functions for each of its attributes. [Figure 13-23](#) shows a UML diagram for the `Customer` class.

**Figure 13-23** UML diagram for the `Customer` class



## The `Car` Class

In the context of our problem domain, what must an object of the `Car` class know? The following items are all attributes of a car and are mentioned in the problem domain:

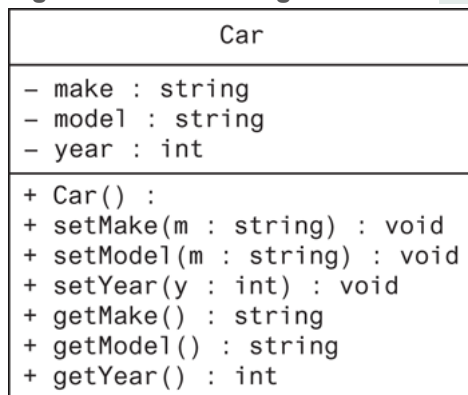
- the car's make
- the car's model
- the car's year

Now let's identify the class's member functions. In the context of our problem domain, what must the `Car` class do? Once again, the only obvious actions are the standard set of member functions that we will find in most classes (constructors, accessors, and mutators). Specifically, the actions are:

- create an object of the `Car` class
- set and get the car's make
- set and get the car's model
- set and get the car's year

**Figure 13-24** shows a UML diagram for the `Car` class at this point.

**Figure 13-24 UML diagram for the `Car` class**



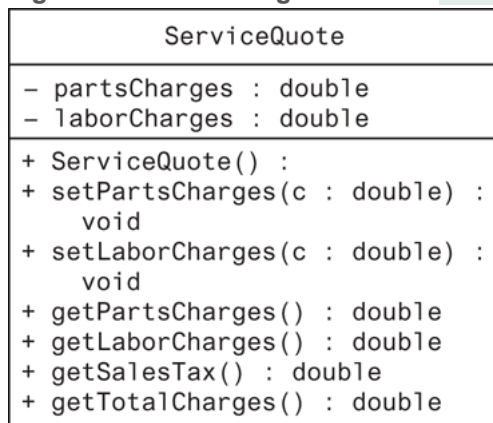
## The `ServiceQuote` Class

In the context of our problem domain, what must an object of the `ServiceQuote` class know? The problem domain mentions the following items:

- the estimated parts charges
- the estimated labor charges
- the sales tax
- the total estimated charges

Careful thought and a little brainstorming will reveal that two of these items are the results of calculations: sales tax, and total estimated charges. These items are dependent on the values of the estimated parts and labor charges. In order to avoid the risk of holding stale data, we will not store these values in member variables. Rather, we will provide member functions that calculate these values and return them. The other member functions we will need for this class are a constructor and the accessors and mutators for the estimated parts charges and estimated labor charges attributes. [Figure 13-25](#) shows a UML diagram for the `ServiceQuote` class.

**Figure 13-25 UML diagram for the `ServiceQuote` class**



# This Is Only the Beginning

You should look at the process that we have discussed in this section as merely a starting point. It's important to realize that designing an object-oriented application is an iterative process. It may take you several attempts to identify all of the classes that you will need and determine all of their responsibilities. As the design process unfolds, you will gain a deeper understanding of the problem, and consequently you will see ways to improve the design.

## *Checkpoint*

13.27 What is a problem domain?

13.28 When designing an object-oriented application, who should write a description of the problem domain?

13.29 How do you identify the potential classes in a problem domain description?

13.30 What are a class's responsibilities?

13.31 What two questions should you ask to determine a class's responsibilities?

13.32 Will all of a class's actions always be directly mentioned in the problem domain description?

13.33 Look at the following description of a problem domain:

A doctor sees patients in her practice. When a patient comes to the practice, the doctor performs one or more procedures on the patient. Each procedure that the doctor performs has a description and a standard fee. As the patient leaves the practice, he or she receives a statement from the office manager. The statement shows the patient's name and address, as well as the procedures that were performed, and the total charge for the procedures.

Assume you are writing an application to generate a statement that can be printed and given to the patient.

- A. Identify all of the potential classes in this problem domain.
- B. Refine the list to include only the necessary class or classes for this problem.
- C. Identify the responsibilities of the class or classes that you identified in step B.

# Review Questions and Exercises

## Short Answer

1. What is the difference between a class and an instance of the class?
2. What is the difference between the following `Person` structure and `Person` class?

```
struct Person
{
    string name;
    int age;
};

class Person
{
    string name;
    int age;
};
```

3. What is the default access specification of class members?
4. Look at the following function header for a member function:

```
void Circle::getRadius()
```

What is the name of the function?

Of, what class is the function a member?

5. A contractor uses a blueprint to build a set of identical houses. Are classes analogous to the blueprint or the houses?
6. What is a mutator function? What is an accessor function?
7. Is it a good idea to make member variables private? Why or why not?
8. Can you think of a good reason to avoid writing statements in a class member function that use `cout` or `cin`?
9. Under what circumstances should a member function be private?
10. What is a constructor? What is a destructor?
11. What is a default constructor? Is it possible to have more than one default constructor?
12. Is it possible to have more than one constructor? Is it possible to have more than one destructor?
13. If a class object is dynamically allocated in memory, does its constructor execute? If so, when?
14. When defining an array of class objects, how do you pass arguments to the constructor for each object in the array?
15. What are a class's responsibilities?
16. How do you identify the classes in a problem domain description?

# Fill-in-the-Blank

17. The two common programming methods in practice today are \_\_\_\_\_ and \_\_\_\_\_.
18. \_\_\_\_\_ programming is centered around functions or procedures.
19. \_\_\_\_\_ programming is centered around objects.
20. \_\_\_\_\_ is an object's ability to contain and manipulate its own data.
21. In C++, the \_\_\_\_\_ is the construct primarily used to create objects.
22. A class is very similar to a(n) \_\_\_\_\_.
23. A(n) \_\_\_\_\_ is a key word inside a class declaration that establishes a member's accessibility.
24. The default access specification of class members is \_\_\_\_\_.
25. The default access specification of a `struct` in C++ is \_\_\_\_\_.
26. Defining a class object is often called the \_\_\_\_\_ of a class.
27. Members of a class object may be accessed through a pointer to the object by using the \_\_\_\_\_ operator.
28. If you were writing the declaration of a class named `Canine`, what would you name the file it was stored in? \_\_\_\_\_
29. If you were writing the external definitions of the `Canine` class's member functions, you would save them in a file named \_\_\_\_\_.

30. When a member function's body is written inside a class declaration, the function is \_\_\_\_\_.
31. A(n) \_\_\_\_\_ is automatically called when an object is created.
32. A(n) \_\_\_\_\_ is a member function with the same name as the class.
33. \_\_\_\_\_ are useful for performing initialization or setup routines in a class object.
34. Constructors cannot have a(n) \_\_\_\_\_ type.
35. A(n) \_\_\_\_\_ constructor is one that requires no arguments.
36. A(n) \_\_\_\_\_ is a member function that is automatically called when an object is destroyed.
37. A destructor has the same name as the class, but is preceded by a(n) \_\_\_\_\_ character.
38. Like constructors, destructors cannot have a(n) \_\_\_\_\_ type.
39. A constructor whose arguments all have default values is a(n) \_\_\_\_\_ constructor.
40. A class may have more than one constructor, as long as each has a different \_\_\_\_\_.
41. A class may only have one default \_\_\_\_\_ and one \_\_\_\_\_.
42. A(n) \_\_\_\_\_ may be used to pass arguments to the constructors of elements in an object array.



# Algorithm Workbench

43. Write a class declaration named `Circle` with a private member variable named `radius`. Write set and get functions to access the `radius` variable, and a function named `getArea` that returns the area of the circle. The area is calculated as

```
3.14159 * radius * radius
```

44. Add a default constructor to the `Circle` class in Question 43. The constructor should initialize the `radius` member to 0.
45. Add an overloaded constructor to the `Circle` class in Question 44. The constructor should accept an argument and assign its value to the `radius` member variable.
46. Write a statement that defines an array of five objects of the `Circle` class in Question 45. Let the default constructor execute for each element of the array.
47. Write a statement that defines an array of five objects of the `Circle` class in Question 45. Pass the following arguments to the elements' constructor: 12, 7, 9, 14, and 8.
48. Write a `for` loop that displays the radius and area of the circles represented by the array you defined in Question 47.
49. If the items on the following list appeared in a problem domain description, which would be potential classes?
50. Look at the following description of a problem domain:

The bank offers the following types of accounts to its customers: savings accounts, checking accounts, and money market accounts. Customers are allowed to deposit money into an account (thereby increasing its balance), withdraw money from an account (thereby decreasing its balance), and earn interest on the account. Each account has an interest rate.

Assume you are writing an application that will calculate the amount of interest earned for a bank account.

- A. Identify the potential classes in this problem domain.
- B. Refine the list to include only the necessary class or classes for this problem.
- C. Identify the responsibilities of the class or classes.

# True or False

51. T F Private members must be declared before public members.
52. T F Class members are private by default.
53. T F Members of a `struct` are private by default.
54. T F Classes and structures in C++ are very similar.
55. T F All private members of a class must be declared together.
56. T F All public members of a class must be declared together.
57. T F It is legal to define a pointer to a class object.
58. T F You can use the `new` operator to dynamically allocate an instance of a class.
59. T F A private member function may be called from a statement outside the class, as long as the statement is in the same program as the class declaration.
60. T F Constructors do not have to have the same name as the class.
61. T F Constructors may not have a return type.
62. T F Constructors cannot take arguments.
63. T F Destructors cannot take arguments.
64. T F Destructors may return a value.
65. T F Constructors may have default arguments.
66. T F Member functions may be overloaded.
67. T F Constructors may not be overloaded.
68. T F A class may not have a constructor with no parameter list, and a constructor whose arguments all have default values.
69. T F A class may only have one destructor.

70. T F When an array of objects is defined, the constructor is only called for the first element.
71. T F To find the classes needed for an object-oriented application, you identify all of the verbs in a description of the problem domain.
72. T F A class's responsibilities are the things the class is responsible for knowing, and actions the class must perform.

# Find the Errors

Each of the following class declarations or programs contain errors.  
Find as many as possible.

```
73. class Circle:
    {
    private
        double centerX;
        double centerY;
        double radius;
    public
        setCenter(double, double);
        setRadius(double);
    }
```

74.

```
#include <iostream>
using namespace std;

Class Moon;
{
Private;
    double earthWeight;
    double moonWeight;
Public;
    moonWeight(double ew);
    { earthWeight = ew; moonWeight = earthWeight / 6; }
    double getMoonWeight();
    { return moonWeight; }
}

int main()
{
    double earth;
    cout >> "What is your weight? ";
    cin << earth;
    Moon lunar(earth);
    cout << "On the moon you would weigh "
        <<lunar.getMoonWeight() << endl;
    return 0;
}
```

75.

```
#include <iostream>

using namespace std;

class DumbBell;

{
    int weight;
public:
    void setWeight(int);
};

void setWeight(int w)
{
    weight = w;
}

int main()
{
    DumbBell bar;

    DumbBell(200);

    cout << "The weight is " << bar.weight << endl;

    return 0;
}
```

76.

```
class Change
{
public:
    int pennies;
    int nickels;
    int dimes;
    int quarters;
    Change()
        { pennies = nickels = dimes = quarters = 0; }
    Change(int p = 100, int n = 50, d = 50, q = 25);
};

void Change::Change(int p, int n, d, q)
{
    pennies = p;
    nickels = n;
    dimes = d;
    quarters = q;
}
```



# Programming Challenges

## 1. Date

Design a class called `Date`. The class should store a date in three integers: `month`, `day`, and `year`. There should be member functions to print the date in the following forms:  
12/25/2018

December 25, 2018

25 December 2018

Demonstrate the class by writing a complete program implementing it.

*Input Validation: Do not accept values for the day greater than 31 or less than 1. Do not accept values for the month greater than 12 or less than 1.*



Solving the `Employee` Class Problem

## 2. `Employee` Class

Write a class named `Employee` that has the following member variables:

- `name` —a string that holds the employee's name
- `idNumber` —a n `int` variable that holds the employee's ID number
- `department` —a string that holds the name of the department where the employee works
- `position` —a string that holds the employee's job title

The class should have the following constructors:

- A constructor that accepts the following values as arguments and assigns them to the appropriate member variables: employee's name, employee's ID number, department, and position.
- A constructor that accepts the following values as arguments and assigns them to the appropriate member variables: employee's name and ID number. The `department` and `position` fields should be assigned an empty string (`""`).
- A default constructor that assigns empty strings (`""`) to the `name`, `department`, and `position` member variables, and 0 to the `idNumber` member variable.

Write appropriate mutator functions that store values in these member variables and accessor functions that return the values in these member variables. Once you have written the

class, write a separate program that creates three `Employee` objects to hold the following data:

The program should store this data in the three objects and then display the data for each employee on the screen.

### 3. `Car` Class

Write a class named `Car` that has the following member variables:

- `yearModel`—an `int` that holds the car's year model
- `make`—a string that holds the make of the car
- `speed`—an `int` that holds the car's current speed

In addition, the class should have the following constructor and other member functions:

- **Constructor**—The constructor should accept the car's year model and make as arguments. These values should be assigned to the object's `yearModel` and `make` member variables. The constructor should also assign 0 to the `speed` member variables.
- **Accessor**—appropriate accessor functions to get the values stored in an object's `yearModel`, `make`, and `speed` member variables
- `accelerate`—The `accelerate` function should add 5 to the `speed` member variable each time it is called.
- `brake`—The `brake` function should subtract 5 from the `speed` member variable each time it is called.

Demonstrate the class in a program that creates a `Car` object, then calls the `accelerate` function five times. After each call to the `accelerate` function, get the current speed of the car and display it. Then, call the `brake` function five times. After each call to the `brake` function, get the current speed of the car and display it.

#### 4. Patient Charges

Write a class named `Patient` that has member variables for the following data:

- First name, middle name, last name
- Address, city, state, and ZIP code
- Phone number
- Name and phone number of emergency contact

The `Patient` class should have a constructor that accepts an argument for each member variable. The `Patient` class should also have accessor and mutator functions for each member variable.

Next, write a class named `Procedure` that represents a medical procedure that has been performed on a patient. The `Procedure` class should have member variables for the following data:

- Name of the procedure
- Date of the procedure
- Name of the practitioner who performed the procedure
- Charges for the procedure

The `Procedure` class should have a constructor that accepts an argument for each member variable. The `Procedure` class should also have accessor and mutator functions for each member variable.

Next, write a program that creates an instance of the `Patient` class, initialized with sample data. Then, create three instances of the `Procedure` class, initialized with the following data:

The program should display the patient's information, information about all three of the procedures, and the total charges of the three procedures.

#### 5. `RetailItem` Class

Write a class named `RetailItem` that holds data about an item in a retail store. The class should have the following member variables:

- `description`—a string that holds a brief description of the item
- `unitsOnHand`—an `int` that holds the number of units currently in inventory
- `price`—a `double` that holds the item's retail price

Write a constructor that accepts arguments for each member variable, appropriate mutator functions that store values in these member variables, and accessor functions that return the values in these member variables. Once you have written the class, write a separate program that creates three `RetailItem` objects and stores the following data in them:

## 6. Inventory Class

Design an `Inventory` class that can hold information and calculate data for items in a retail store's inventory. The class should have the following *private* member variables:

The class should have the following *public* member functions:  
Demonstrate the class in a driver program.

*Input Validation: Do not accept negative values for item number, quantity, or cost.*

## 7. TestScores Class

Design a `TestScores` class that has member variables to hold three test scores. The class should have a constructor, accessor, and mutator functions for the test score fields and a member function that returns the average of the test scores. Demonstrate the class by writing a separate program that creates an instance of the class. The program should ask the user to enter three test scores, which are stored in the `TestScores` object. Then the program should display the average of the scores, as reported by the `TestScores` object.

## 8. Circle Class

Write a `Circle` class that has the following member variables:

- `radius`—a `double`
- `pi`—a `double` initialized with the value 3.14159

The class should have the following member functions:

- Default Constructor—a default constructor that sets `radius` to 0.0

- Constructor—accepts the radius of the circle as an argument
- `setRadius`—a mutator function for the radius variable
- `getRadius`—an accessor function for the radius variable
- `getArea`—returns the area of the circle, which is calculated as

```
area = pi * radius * radius
```

- `getDiameter`—returns the diameter of the circle, which is calculated as

```
diameter = radius * 2
```

- `getCircumference`—returns the circumference of the circle, which is calculated as

```
circumference = 2 * pi * radius
```

Write a program that demonstrates the `Circle` class by asking the user for the circle's radius, creating a `Circle` object, then reporting the circle's area, diameter, and circumference.

## 9. Population

In a population, the birth rate and death rate are calculated as follows:

$$\text{Birth Rate} = \text{Number of Births} \div \text{Population}$$
$$\text{Death Rate} = \text{Number of Deaths} \div \text{Population}$$

For example, in a population of 100,000 that has 8,000 births and 6,000 deaths per year, the birth rate and death rate are:

$$\text{Birth Rate} = 8,000 \div 100,000 = 0.08$$
$$\text{Death Rate} = 6,000 \div 100,000 = 0.06$$

Design a `Population` class that stores a population, number of births, and number of deaths for a period of time. Member functions should return the birth rate and death rate.

Implement the class in a program.

*Input Validation: Do not accept population figures less than 1, or birth or death numbers less than 0.*

#### 10. **Number Array Class**

Design a class that has an array of floating-point numbers.

The constructor should accept an integer argument and dynamically allocate the array to hold that many numbers.

The destructor should free the memory held by the array. In

addition, there should be member functions to perform the following operations:

- Store a number in any element of the array
- Retrieve a number from any element of the array
- Return the highest value stored in the array
- Return the lowest value stored in the array
- Return the average of all the numbers stored in the array



Demonstrate the class in a program.

## 11. Payroll Class

Design a `PayRoll` class that has data members for an employee's hourly pay rate, number of hours worked, and total pay for the week. Write a program with an array of seven `PayRoll` objects. The program should ask the user for the number of hours each employee has worked, and will then display the amount of gross pay each has earned.

*Input Validation: Do not accept values greater than 60 for the number of hours worked.*

## 12. Coin Toss Simulator

Write a class named `Coin`. The `Coin` class should have the following member variable:

- A `string` named `sideUp`. The `sideUp` member variable will hold either "heads" or "tails" indicating the side of the coin that is facing up.

The `Coin` class should have the following member functions:

- A default constructor that randomly determines the side of the coin that is facing up ("heads" or "tails") and initializes the `sideUp` member variable accordingly.
- A `void` member function named `toss` that simulates the tossing of the coin. When the `toss` member function is called, it randomly determines the side of the coin that is facing up ("heads" or "tails") and sets the `sideUp` member variable accordingly.

- A member function named `getSideUp` that returns the value of the `sideUp` member variable.

Write a program that demonstrates the `Coin` class. The program should create an instance of the class and display the side that is initially facing up. Then, use a loop to toss the coin 20 times. Each time the coin is tossed, display the side that is facing up. The program should keep count of the number of times heads is facing up and the number of times tails is facing up, and display those values after the loop finishes.

### 13. Tossing Coins for a Dollar

For this assignment, you will create a game program using the `Coin` class from Programming Challenge 12 (Coin Toss Simulator). The program should have three instances of the `Coin` class: one representing a quarter, one representing a dime, and one representing a nickel.

When the game begins, your starting balance is \$0. During each round of the game, the program will toss the simulated coins. When a coin is tossed, the value of the coin is added to your balance if it lands heads-up. For example, if the quarter lands heads-up, 25 cents is added to your balance. Nothing is added to your balance for coins that land tails-up. The game is over when your balance reaches \$1 or more. If your balance is exactly \$1, you win the game. You lose if your balance exceeds \$1.

### 14. Fishing Game Simulation

For this assignment, you will write a program that simulates a fishing game. In this game, a six-sided die is rolled to determine what the user has caught. Each possible item is worth a certain number of fishing points. The points will not be displayed until the user has finished fishing, then a message is displayed congratulating the user depending on the number of fishing points gained.

Here are some suggestions for the game's design:

- Each round of the game is performed as an iteration of a loop that repeats as long as the player wants to fish for more items.
- At the beginning of each round, the program will ask the user whether he or she wants to continue fishing.
- The program simulates the rolling of a six-sided die (use the `Die` class that was demonstrated in this chapter).
- Each item that can be caught is represented by a number generated from the die. For example, 1 for "a huge fish," 2 for "an old shoe," 3 for "a little fish," and so on.
- Each item the user catches is worth a different amount of points.
- The loop keeps a running total of the user's fishing points.
- After the loop has finished, the total number of fishing points is displayed, along with a message that varies depending on the number of points earned.

## 15. Mortgage Payment

Design a class that will determine the monthly payment on a home mortgage. The monthly payment with interest compounded monthly can be calculated as follows:

$$\text{Payment} = \frac{\text{Loan} \times \frac{\text{Rate}}{12} \times \text{Term}}{\text{Term} - 1}$$

where

$$\text{Term} = \left(1 + \frac{\text{Rate}}{12}\right)^{12 \times \text{Years}}$$

Payment = the monthly payment

Loan = the dollar amount of the loan

Rate = the annual interest rate

Years = the number of years of the loan

The class should have member functions for setting the loan amount, interest rate, and number of years of the loan. It should also have member functions for returning the monthly payment amount and the total amount paid to the bank at the end of the loan period. Implement the class in a complete program.

*Input Validation: Do not accept negative numbers for any of the loan values.*

## 16. Freezing and Boiling Points

The following table lists the freezing and boiling points of several substances.

Design a class that stores a temperature in a `temperature` member variable and has the appropriate accessor and mutator functions. In addition to appropriate constructors, the class should have the following member functions:

- `isEthylFreezing`—This function should return the `bool` value `true` if the temperature stored in the `temperature` field is at or below the freezing point of ethyl alcohol. Otherwise, the function should return `false`.
- `isEthylBoiling`—This function should return the `bool` value `true` if the temperature stored in the `temperature` field is at or above the boiling point of ethyl alcohol. Otherwise, the function should return `false`.
- `isOxygenFreezing`—This function should return the `bool` value `true` if the temperature stored in the `temperature` field is at or below the freezing point of oxygen. Otherwise, the function should return `false`.
- `isOxygenBoiling`—This function should return the `bool` value `true` if the temperature stored in the `temperature` field is at or above the boiling point of oxygen. Otherwise, the function should return `false`.
- `isWaterFreezing`—This function should return the `bool` value `true` if the temperature stored in the `temperature` field is at or below the freezing point of water. Otherwise, the function should return `false`.
- `isWaterBoiling`—This function should return the `bool` value `true` if the temperature stored in the `temperature` field is at or above the boiling point of water. Otherwise, the function should return `false`.

Write a program that demonstrates the class. The program should ask the user to enter a temperature, then display a list

of the substances that will freeze at that temperature, and those that will boil at that temperature. For example, if the temperature is  $-20$  the class should report that water will freeze and oxygen will boil at that temperature.

## 17. Cash Register

Design a `CashRegister` class that can be used with the `InventoryItem` class discussed in this chapter. The `CashRegister` class should perform the following:

1. Ask the user for the item and quantity being purchased.
2. Get the item's cost from the `InventoryItem` object.
3. Add a 30 percent profit to the cost to get the item's unit price.
4. Multiply the unit price times the quantity being purchased to get the purchase subtotal.
5. Compute a 6 percent sales tax on the subtotal to get the purchase total.
6. Display the purchase subtotal, tax, and total on the screen.
7. Subtract the quantity being purchased from the `onHand` variable of the `InventoryItem` class object.

Implement both classes in a complete program. Feel free to modify the `InventoryItem` class in any way necessary.

*Input Validation: Do not accept a negative value for the quantity of items being purchased.*

## 18. A Game of 21

For this assignment, you will write a program that lets the user play against the computer in a variation of the popular

blackjack card game. In this variation of the game, two six-sided dice are used instead of cards. The dice are rolled, and the player tries to beat the computer's hidden total without going over 21.

Here are some suggestions for the game's design:

- Each round of the game is performed as an iteration of a loop that repeats as long as the player agrees to roll the dice, and the player's total does not exceed 21.
- At the beginning of each round, the program will ask the users whether they want to roll the dice to accumulate points.
- During each round, the program simulates the rolling of two six-sided dice. It rolls the dice first for the computer, then it asks the user if he or she wants to roll. (Use the `Die` class demonstrated in this chapter to simulate the dice).
- The loop keeps a running total of both the computer and the user's points.
- The computer's total should remain hidden until the loop has finished.
- After the loop has finished, the computer's total is revealed, and the player with the most points without going over 21 wins.

## 19. Trivia Game

In this programming challenge, you will create a simple trivia game for two players. The program will work like this:

- Starting with player 1, each player gets a turn at answering five trivia questions. (There are a total of 10 questions.)

When a question is displayed, four possible answers are also displayed. Only one of the answers is correct, and if the player selects the correct answer, he or she earns a point.

- After answers have been selected for all of the questions, the program displays the number of points earned by each player and declares the player with the highest number of points the winner.

In this program, you will design a `Question` class to hold the data for a trivia question. The `Question` class should have member variables for the following data:

- A trivia question
- Possible answer #1
- Possible answer #2
- Possible answer #3
- Possible answer #4
- The number of the correct answer (1, 2, 3, or 4)

The `Question` class should have appropriate constructor(s), accessor, and mutator functions.

The program should create an array of 10 `Question` objects, one for each trivia question. Make up your own trivia questions on the subject or subjects of your choice for the objects.



# Group Project

## 20. Patient Fees

1. This program should be designed and written by a team of students. Here are some suggestions:
  - One or more students may work on a single class.
  - The requirements of the program should be analyzed so that each student is given about the same workload.
  - The parameters and return types of each function and class member function should be decided in advance.
  - The program will be best implemented as a multi-file program.
2. You are to write a program that computes a patient's bill for a hospital stay. The different components of the program are
  - The `PatientAccount` class
  - The `Surgery` class
  - The `Pharmacy` class
  - The `main` program

- The `PatientAccount` class will keep a total of the patient's charges. It will also keep track of the number of days spent in the hospital. The group must decide on the hospital's daily rate.
- The `Surgery` class will have stored within it the charges for at least five types of surgery. It can update the charges variable of the `PatientAccount` class.
- The `Pharmacy` class will have stored within it the price of at least five types of medication. It can update the charges variable of the `PatientAccount` class.
- The student who designs the main program will design a menu that allows the user to enter a type of surgery and a type of medication, and check the patient out of the hospital. When the patient checks out, the total charges should be displayed.

---

# Chapter 14 More about Classes

---

## Topics

**14.1 Instance and Static Members** 

**14.2 Friends of Classes** 

**14.3 Memberwise Assignment** 

**14.4 Copy Constructors** 

**14.5 Operator Overloading** 

**14.6 Object Conversion** 

**14.7 Aggregation** 

**14.8 Focus on Object-Oriented Design: Class Collaborations** 

**14.9 Focus on Object-Oriented Programming: Simulating the Game of Cho-Han** 

**14.10 Rvalue References and Move Semantics** 

# 14.1 Instance and Static Members

## **Concept:**

Each instance of a class has its own copies of the class's instance variables. If a member variable is declared `static`, however, all instances of that class have access to that variable. If a member function is declared `static`, it may be called without any instances of the class being defined.

# Instance Variables

Each class object (an instance of a class) has its own copy of the class's member variables. An object's member variables are separate and distinct from the member variables of other objects of the same class. For example, recall that the `Rectangle` class discussed in [Chapter 13](#) has two member variables: `width` and `length`. Suppose we define two objects of the `Rectangle` class and set their `width` and `length` member variables as shown in the following code.

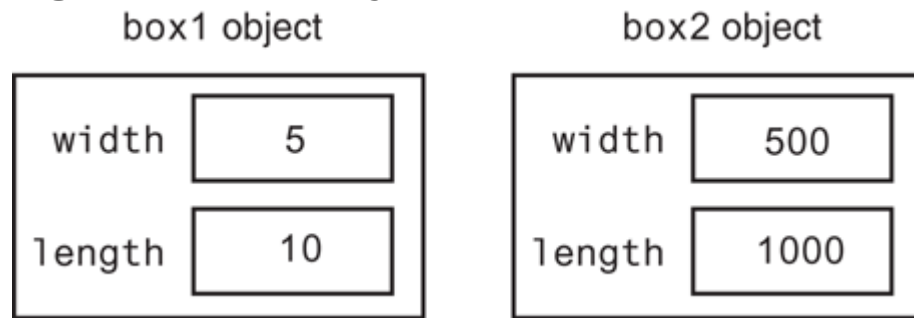
```
Rectangle box1, box2;

// Set the width and length for box1.
box1.setWidth(5);
box1.setLength(10);

// Set the width and length for box2.
box2.setWidth(500);
box2.setLength(1000);
```

This code creates `box1` and `box2`, which are two distinct objects. Each has its own `width` and `length` member variables, as illustrated in [Figure 14-1](#).

**Figure 14-1 Two objects**



When the `getWidth` member function is called, it returns the value stored in the calling object's `width` member variable. For example, the following statement displays `5 500`.

```
cout << box1.getWidth() << " " << box2.getWidth() << endl;
```

In object-oriented programming, member variables such as the `Rectangle` class's `width` and `length` members are known as *instance variables*. They are called instance variables because each instance of the class has its own copies of the variables.

# Static Members

It is possible to create a member variable or member function that does not belong to any instance of a class. Such members are known as *static member variables* and *static member functions*.

When a value is stored in a static member variable, it is not stored in an instance of the class. In fact, an instance of the class doesn't even have to exist in order for values to be stored in the class's static member variables. Likewise, static member functions do not operate on instance variables. Instead, they can operate only on static member variables. You can think of static member variables and static member functions as belonging to the class instead of to an instance of the class. In this section, we will take a closer look at static members. First, we will examine static member variables.

# Static Member Variables

When a member variable is declared with the key word `static`, there will be only one copy of the member variable in memory, regardless of the number of instances of the class that might exist. A single copy of a class's static member variable is shared by all instances of the class. For example, the following `Tree` class uses a static member variable to keep count of the number of instances of the class that are created.



## Contents of `Tree.h`

```
1 // Tree class
2 class Tree
3 {
4     private:
5         static int objectCount; // Static
member variable.
6     public:
7         // Constructor
8         Tree()
9             { objectCount++; }
10
11         // Accessor function for objectCount
12         int getObjectCount() const
13             { return objectCount; }
14 };
15
16 // Definition of the static member variable,
written
```

```
17 // outside the class.  
18 int Tree::objectCount = 0;
```

First, notice in line 5 the declaration of the static member variable named `objectCount`: A static member variable is created by placing the key word `static` before the variable's data type. Also notice in line 18, we have written a definition statement for the `objectCount` variable, and that the statement is outside the class declaration. This external definition statement causes the variable to be created in memory, and is required. In line 18, we have explicitly initialized the `objectCount` variable with the value 0. We could have left out the initialization because C++ automatically stores 0 in all uninitialized static member variables. It is a good practice to initialize the variable anyway, so it is clear to anyone reading the code that the variable starts out with the value 0.

Next, look at the constructor in lines 8 and 9. In line 9, the `++` operator is used to increment `objectCount`. Each time an instance of the `Tree` class is created, the constructor will be called, and the `objectCount` member variable will be incremented. As a result, the `objectCount` member variable will contain the number of instances of the `Tree` class that have been created. The `getObjectCount` function, in lines 12 and 13, returns the value in `objectCount`.

**Program 14-1**  demonstrates this class.

## Program 14-1

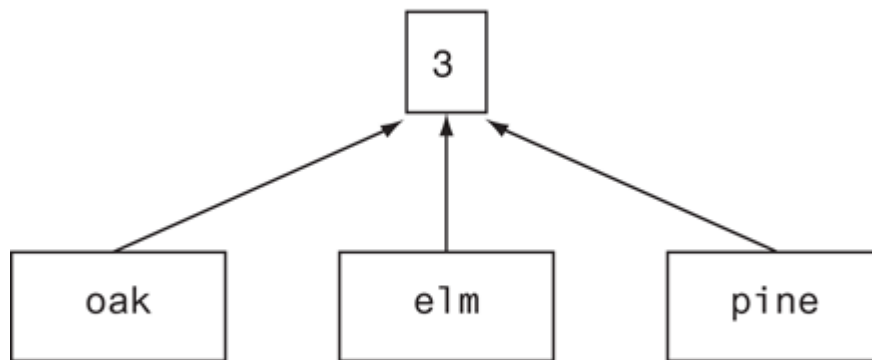
```
1 // This program demonstrates a static member
variable.
2 #include <iostream>
3 #include "Tree.h"
4 using namespace std;
5
6 int main()
7 {
8     // Define three Tree objects.
9     Tree oak;
10    Tree elm;
11    Tree pine;
12
13    // Display the number of Tree objects we
have.
14    cout << "We have " <<
pine.getObjectCount()
15    << " trees in our program!\n";
16    return 0;
17 }
```

## Program Output

```
We have 3 trees in our program!
```

The program creates three instances of the `Tree` class, stored in the variables `oak`, `elm`, and `pine`. Although there are three instances of the class, there is only one copy of the static `objectCount` variable. This is illustrated in [Figure 14-2](#).

**Figure 14-2 A static variable**  
objectCount variable  
(static)





Instances of the Tree class

In line 14, the program calls the `getObjectCount` member function to retrieve the number of instances that have been created. Although the program uses the `pine` object to call the member function, the same value would be returned if any of the objects had been used.

For example, all three of the following `cout` statements would display the same thing:

```
cout << "We have " << oak.getObjectCount() << " trees\n";  
cout << "We have " << elm.getObjectCount() << " trees\n";  
cout << "We have " << pine.getObjectCount() << " trees\n";
```

A more practical use of a static member variable is demonstrated in **Program 14-2** . The `Budget` class is used to gather the budget requests for all the divisions of a company. The class uses a static member, `corpBudget`, to hold the amount of the overall corporate budget. When the member function `addBudget` is called, its argument is added to the current contents of `corpBudget`. By the time the program is finished, `corpBudget` will contain the total of all the values placed there by all the `Budget` class objects. (These files can be found in the Student Source Code Folder **Chapter 14**  \Budget Version 1.)

## Contents of `Budget.h` (Version 1)

```
1  #ifndef BUDGET_H
2  #define BUDGET_H
3
4  // Budget class declaration
5  class Budget
6  {
7  private:
8      static double corpBudget; // Static
member
9      double divisionBudget; // Instance
member
10 public:
11     Budget()
12         { divisionBudget = 0; }
13
14     void addBudget(double b)
15         { divisionBudget += b;
16           corpBudget += b; }
17
18     double getDivisionBudget() const
19         { return divisionBudget; }
20
21     double getCorpBudget() const
```

```
22     { return corpBudget; }
23 };
24
25 // Definition of static member variable
corpBudget
26 double Budget::corpBudget = 0;
27
28 #endif
```

## Program 14-2

```
1 // This program demonstrates a static class
member variable.
2 #include <iostream>
3 #include <iomanip>
4 #include "Budget.h"
5 using namespace std;
6
7 int main()
8 {
9     int count; // Loop
counter
10    const int NUM_DIVISIONS = 4; //
Number of divisions
11    Budget divisions[NUM_DIVISIONS]; // Array
of Budget objects
12
13    // Get the budget requests for each
division.
14    for (count = 0; count < NUM_DIVISIONS;
count++)
15    {
16        double budgetAmount;
17        cout << "Enter the budget request for
```



```
division ";
18         cout << (count + 1) << ": ";
19         cin >> budgetAmount;
20
21     divisions[count].addBudget(budgetAmount);
22
23     // Display the budget requests and the
    corporate budget.
24     cout << fixed << showpoint <<
    setprecision(2);
25     cout << "\nHere are the division budget
    requests:\n";
26     for (count = 0; count < NUM_DIVISIONS;
    count++)
27     {
28         cout << "\tDivision " << (count + 1)
    << "\t$ ";
29         cout <<
    divisions[count].getDivisionBudget() << endl;
30     }
31     cout << "\tTotal Budget Requests:\t$ ";
32     cout << divisions[0].getCorpBudget() <<
    endl;
33
34     return 0;
35 }
```

## Program Output with Example Input Shown in Bold

Enter the budget request for division 1:

**100000** Enter

Enter the budget request for division 2:

**200000** Enter

Enter the budget request for division 3:

**300000** Enter

Enter the budget request for division 4:

**400000** Enter

Here are the division budget requests:

Division 1      \$ 100000.00

Division 2      \$ 200000.00

Division 3      \$ 300000.00

Division 4      \$ 400000.00

Total Budget Requests:    \$ 1000000.00




# Static Member Functions

You declare a static member function by placing the `static` keyword in the function's prototype. Here is the general form:

```
static ReturnType FunctionName (ParameterTypeList);
```

A function that is a static member of a class cannot access any nonstatic member data in its class. With this limitation in mind, you might wonder what purpose static member functions serve. The following two points are important for understanding their usefulness:

1. Even though static member variables are declared in a class, they are actually defined outside the class declaration. The lifetime of a class's static member variable is the lifetime of the program. This means that a class's static member variables come into existence before any instances of the class are created.
2. A class's static member functions can be called before any instances of the class are created. This means that a class's static member functions can access the class's static member variables *before* any instances of the class are defined in memory. This gives you the ability to create very specialized setup routines for class objects.

**Program 14-3** , a modification of **Program 14-2** , demonstrates this feature. It asks the user to enter the main office's budget request before any division requests are entered. The `Budget` class has been modified to include a static member function named `mainOffice`. This function adds its argument to the static `corpBudget` variable, and is called before any instances of the `Budget` class are defined. (These files can be found in the Student Source Code Folder **Chapter 14**  \Budget Version 2.)

## Contents of `Budget.h` (Version 2)

```
1  #ifndef BUDGET_H
2  #define BUDGET_H
3
4  // Budget class declaration
5  class Budget
6  {
7  private:
8      static double corpBudget; // Static
member variable
9      double divisionBudget; // Instance
member variable
10 public:
11     Budget()
12         { divisionBudget = 0; }
13
14     void addBudget(double b)
15         { divisionBudget += b;
16           corpBudget += b; }
17
18     double getDivisionBudget() const
19         { return divisionBudget; }
20
21     double getCorpBudget() const
```

```
22         { return corpBudget; }
23
24     static void mainOffice(double); // Static
member function
25 };
26
27 #endif
```

## Contents of `Budget.cpp`

```
1  #include "Budget.h"
2
3  // Definition of corpBudget static member
variable
4  double Budget::corpBudget = 0;
5
6
//*****
*****
7  // Definition of static member function
mainOffice. *
8  // This function adds the main office's budget
request to *
9  // the corpBudget variable.
*
10
//*****
*****
11
12 void Budget::mainOffice(double moffice)
13 {
```

```
14     corpBudget += moffice;  
15 }
```



## Program 14-3

```
1 // This program demonstrates a static member
function.
2 #include <iostream>
3 #include <iomanip>
4 #include "Budget.h"
5 using namespace std;
6
7 int main()
8 {
9     int count; // Loop
counter
10    double mainOfficeRequest; // Main
office budget request
11    const int NUM_DIVISIONS = 4; // Number
of divisions
12
13    // Get the main office's budget request.
14    // Note that no instances of the Budget
class have been defined.
15    cout << "Enter the main office's budget
request: ";
16    cin >> mainOfficeRequest;
17    Budget::mainOffice(mainOfficeRequest);
```

```
18
19     Budget divisions[NUM_DIVISIONS]; // An
array of Budget objects.
20
21     // Get the budget requests for each
division.
22     for (count = 0; count < NUM_DIVISIONS;
count++)
23     {
24         double budgetAmount;
25         cout << "Enter the budget request for
division ";
26         cout << (count + 1) << ": ";
27         cin >> budgetAmount;
28
divisions[count].addBudget(budgetAmount);
29     }
30
31     // Display the budget requests and the
corporate budget.
32     cout << fixed << showpoint <<
setprecision(2);
33     cout << "\nHere are the division budget
requests:\n";
34     for (count = 0; count < NUM_DIVISIONS;
count++)
35     {
```

```
36         cout << "\tDivision " << (count + 1)
<< "\t$ ";
37         cout <<
divisions[count].getDivisionBudget() << endl;
38     }
39     cout << "\tTotal Budget Requests:\t$ ";
40     cout << divisions[0].getCorpBudget() <<
endl;
41
42     return 0;
43 }
```

**Program Output with Example Input Shown in Bold**

```
Enter the main office's budget request:
100000 Enter
Enter the budget request for division 1:
100000 Enter
Enter the budget request for division 2:
200000 Enter
Enter the budget request for division 3:
300000 Enter
Enter the budget request for division 4:
400000 Enter
```

```
Here are the division budget requests:
```

```
Division 1      $ 100000.00
Division 2      $ 200000.00
Division 3      $ 300000.00
Division 4      $ 400000.00
Total Requests (including main office):
$ 1100000.00
```

Notice in line 17 the statement that calls the static function

```
mainOffice:
```

```
Budget::mainOffice(amount);
```

Calls to static member functions do not use the regular notation of connecting the function name to an object name with the dot operator. Instead, static member functions are called by connecting the function name to the class name with the scope resolution operator.



***Note:***

If an instance of a class with a static member function exists, the static member function can be called with the class object name and the dot operator, just like any other member function.

## 14.2 Friends of Classes


### **Concept:**

A friend is a function or class that is not a member of a class, but has access to the private members of the class.

Private members are hidden from all parts of the program outside the class, and accessing them requires a call to a public member function. Sometimes you will want to create an exception to that rule. A *friend* function is a function that is not part of a class, but that has access to the class's private members. In other words, a friend function is treated as if it were a member of the class. A friend function can be a regular stand-alone function, or it can be a member of another class. (In fact, an entire class can be declared a friend of another class.)

In order for a function or class to become a friend of another class, it must be declared as such by the class granting it access. Classes keep a “list” of their friends, and only the external functions or classes whose names appear in the list are granted access. A function is declared a friend by placing the key word `friend` in front of a prototype of the function. Here is the general format:

```
friend Return Type FunctionName (ParameterTypeList)
```

In the following declaration of the `Budget` class, the `addBudget` function of another class, `AuxiliaryOffice` has been declared a friend. (This file can be found in the Student Source Code Folder **Chapter 14**  Budget Version 3.)

## Contents of `Budget.h` (Version 3)

```
1  #ifndef BUDGET_H
2  #define BUDGET_H
3  #include "Auxil.h"
4
5  // Budget class declaration
6  class Budget
7  {
8  private:
9      static double corpBudget; // Static
member variable
10     double divisionBudget; // Instance
member variable
11 public:
12     Budget()
13         { divisionBudget = 0; }
14
15     void addBudget(double b)
16         { divisionBudget += b;
17           corpBudget += b; }
18
19     double getDivisionBudget() const
20         { return divisionBudget; }
21
```



```

22     double getCorpBudget() const
23     { return corpBudget; }
24
25     // Static member function
26     static void mainOffice(double);
27
28     // Friend function
29     friend void
AuxiliaryOffice::addBudget(double, Budget &);
30 };
31
32 #endif

```

Let's assume another class, `AuxiliaryOffice`, represents a division's auxiliary office, perhaps in another country. The auxiliary office makes a separate budget request, which must be added to the overall corporate budget. The friend declaration of the `AuxiliaryOffice::addBudget` function tells the compiler that the function is to be granted access to `Budget`'s private members. Notice the function takes two arguments: a `double` and a reference object of the `Budget` class. The `Budget` class object that is to be modified by the function is passed to it, by reference, as an argument. The following code shows the declaration of the `AuxiliaryOffice` class. (This file can be found in the Student Source Code Folder [Chapter 14](#) \Budget Version 3.)

## Contents of `Auxil.h`

```
1  #ifndef AUXIL_H
2  #define AUXIL_H
3
4  class Budget; // Forward declaration of Budget
class
5
6  // Aux class declaration
7
8  class AuxiliaryOffice
9  {
10 private:
11     double auxBudget;
12 public:
13     AuxiliaryOffice()
14         { auxBudget = 0; }
15
16     double getDivisionBudget() const
17         { return auxBudget; }
18
19     void addBudget(double, Budget &);
20 };
```

```
21
```

```
22 #endif
```

## Contents of `Auxil.cpp`

```
1  #include "Auxil.h"
2  #include "Budget.h"
3
4
//*****
*****
5  // Definition of member function mainOffice.
*
6  // This function is declared a friend by the
Budget class.  *
7  // It adds the value of argument b to the
static corpBudget  *
8  // member variable of the Budget class.
*
9
//*****
*****
10
11 void AuxiliaryOffice::addBudget(double b,
Budget &div)
12 {
13     auxBudget += b;
```

```
14     div.corpBudget += b;  
15 }
```

Notice the `Auxil.h` file contains the following statement in line 4:

```
class Budget; // Forward declaration of Budget class
```

This is a *forward declaration* of the `Budget` class. It simply tells the compiler that a class named `Budget` will be declared later in the program. This is necessary because the compiler will process the `Auxil.h` file before it processes the `Budget` class declaration. When it is processing the `Auxil.h` file, it will see the following function declaration in line 19:

```
void addBudget(double, Budget &);
```

The `addBudget` function's second parameter is a `Budget` reference variable. At this point, the compiler has not processed the `Budget` class declaration, so, without the forward declaration, it wouldn't know what a `Budget` reference variable is.

The following code shows the definition of the `addBudget` function.  
(This file can be found in the Student Source Code Folder **Chapter 14** \Budget Version 3.)

## Contents of `Auxil.cpp`

```
1  #include "Auxil.h"
2  #include "Budget.h"
3
4
//*****
*****
5  // Definition of member function mainOffice.
*
6  // This function is declared a friend by the
Budget class.  *
7  // It adds the value of argument b to the
static corpBudget  *
8  // member variable of the Budget class.
*
9
//*****
*****
10
11 void AuxiliaryOffice::addBudget(double b,
Budget &div)
12 {
13     auxBudget += b;
```

```
14     div.corpBudget += b;  
15 }
```

The parameter `div`, a reference to a `Budget` class object, is used in line 14. This statement adds the parameter `b` to `div.corpBudget`.

**Program 14-4**  demonstrates the classes.



## Program 14-4

```
1 // This program demonstrates a static member
function.
2 #include <iostream>
3 #include <iomanip>
4 #include "Budget.h"
5 using namespace std;
6
7 int main()
8 {
9     int count; // Loop
counter
10    double mainOfficeRequest; // Main
office budget request
11    const int NUM_DIVISIONS = 4; // Number of
divisions
12
13    // Get the main office's budget request.
14    cout << "Enter the main office's budget
request: ";
15    cin >> mainOfficeRequest;
16    Budget::mainOffice(mainOfficeRequest);
17
18    Budget divisions[NUM_DIVISIONS]; // Array
```

```
of Budget objects
19     AuxiliaryOffice auxOffices[4];    // Array
of AuxiliaryOffice
20
21     // Get the budget requests for each
division
22     // and their auxiliary offices.
23     for (count = 0; count < NUM_DIVISIONS;
count++)
24     {
25         double budgetAmount; // To hold input
26
27         // Get the request for the division
office.
28         cout << "Enter the budget request for
division ";
29         cout << (count + 1) << ": ";
30         cin >> budgetAmount;
31
divisions[count].addBudget(budgetAmount);
32
33         // Get the request for the auxiliary
office.
34         cout << "Enter the budget request for
that division's\n";
35         cout << "auxiliary office: ";
36         cin >> budgetAmount;
```

```
37
auxOffices[count].addBudget(budgetAmount,
divisions[count]);
38     }
39
40     // Display the budget requests and the
corporate budget.
41     cout << fixed << showpoint <<
setprecision(2);
42     cout << "\nHere are the division budget
requests:\n";
43     for (count = 0; count < NUM_DIVISIONS;
count++)
44     {
45         cout << "\tDivision " << (count + 1) <<
"\t\t$";
46         cout <<
divisions[count].getDivisionBudget() << endl;
47         cout << "\tAuxiliary office:\t$";
48         cout <<
auxOffices[count].getDivisionBudget() << endl <<
endl;
49     }
50     cout << "Total Budget Requests:\t$ ";
51     cout << divisions[0].getCorpBudget() <<
endl;
```

```
52     return 0;  
53 }
```

**Program Output with Example Input Shown in Bold**

Enter the main office's budget request:

**100000** Enter

Enter the budget request for division 1:

**100000** Enter

Enter the budget request for that division's  
auxiliary office: **50000** Enter

Enter the budget request for division 2:

**200000** Enter

Enter the budget request for that division's  
auxiliary office: **40000** Enter

Enter the budget request for division 3:

**300000** Enter

Enter the budget request for that division's  
auxiliary office: **70000** Enter

Enter the budget request for division 4:

**400000** Enter

Enter the budget request for that division's  
auxiliary office: **65000** Enter

Here are the division budget requests:

Division 1	\$100000.00
Auxiliary office:	\$50000.00
Division 2	\$200000.00
Auxiliary office:	\$40000.00
Division 3	\$300000.00
Auxiliary office:	\$70000.00
Division 4	\$400000.00

```
Auxiliary office:          $65000.00
Total Budget Requests:    $ 1325000.00
```

As mentioned before, it is possible to make an entire class a friend of another class. The `Budget` class could make the `AuxiliaryOffice` class its friend with the following declaration:

```
friend class AuxiliaryOffice;
```

This may not be a good idea, however. Every member function of `AuxiliaryOffice` (including ones that may be added later) would have access to the private members of `Budget`. The best practice is to declare as friends only those functions that must have access to the private members of the class.



# Checkpoint

14.1 What is the difference between an instance member variable and a static member variable?

14.2 Static member variables are declared inside the class declaration. Where do you write the definition statement for a static member variable?

14.3 Does a static member variable come into existence in memory before, at the same time as, or after any instances of its class?

14.4 What limitation does a static member function have?

14.5 What action is possible with a static member function that isn't possible with an instance member function?

14.6 If class `X` declares function `f` as a friend, does function `f` become a member of class `X`?

14.7 Class `Y` is a friend of class `X`, which means the member functions of class `Y` have access to the private members of class `X`. Does the friend key word appear in class `Y`'s declaration or in class `X`'s declaration?

## 14.3 Memberwise Assignment

### Concept:

The = operator may be used to assign one object's data to another object, or to initialize one object with another object's data. By default, each member of one object is copied to its counterpart in the other object.

Like other variables (except arrays), objects may be assigned to one another using the = operator. As an example, consider [Program 14-5](#), which uses the `Rectangle` class (version 4) we discussed in [Chapter 13](#). Recall that the `Rectangle` class has two member variables: `width` and `length`. The constructor accepts two arguments: one for `width`, and one for `length`.



## Program 14-5

```
1 // This program demonstrates memberwise
assignment.
2 #include <iostream>
3 #include "Rectangle.h"
4 using namespace std;
5
6 int main()
7 {
8     // Define two Rectangle objects.
9     Rectangle box1(10.0, 10.0); // width =
10.0, length = 10.0
10    Rectangle box2 (20.0, 20.0); // width =
20.0, length = 20.0
11
12    // Display each object's width and length.
13    cout << "box1's width and length: " <<
box1.getWidth()
14        << " " << box1.getLength() << endl;
15    cout << "box2's width and length: " <<
box2.getWidth()
16        << " " << box2.getLength() << endl <<
endl;
17
```

```
18     // Assign the members of box1 to box2.
19     box2 = box1;
20
21     // Display each object's width and length
again.
22     cout << "box1's width and length: " <<
box1.getWidth()
23         << " " << box1.getLength() << endl;
24     cout << "box2's width and length: " <<
box2.getWidth()
25         << " " << box2.getLength() << endl;
26
27     return 0;
28 }
```

## Program Output

```
box1's width and length: 10 10
box2's width and length: 20 20

box1's width and length: 10 10
box2's width and length: 10 10
```

The following statement, which appears in line 19, copies the `width` and `length` member variables of `box1` directly into the `width` and `length` member variables of `box2`:

```
box2 = box1;
```

Memberwise assignment also occurs when one object is initialized with another object's values. Remember the difference between assignment and initialization: assignment occurs between two objects that already exist, and initialization happens to an object being created. Consider the following code:

```
// Define box1.  
Rectangle box1(100.0, 50.0);  
  
// Define box2, initialize with box1's values  
Rectangle box2 = box1;
```

The last statement defines a `Rectangle` object, `box2`, and initializes it to the values stored in `box1`. Because memberwise assignment takes place, the `box2` object will contain the exact same values as the `box1` object.

## 14.4 Copy Constructors

### **Concept:**

A copy constructor is a special constructor that is called whenever a new object is created and initialized with another object's data.

Sometimes the default memberwise assignment behavior in C++ is perfectly acceptable. There are many situations, however, where memberwise assignment cannot be used. For example, consider the following class. (This file can be found in the Student Source Code Folder [Chapter 14](#) \StudentTestScores Version 1.)

## Contents of `StudentTestScores.h` (Version 1)

```
1  #ifndef STUDENTTESTSCORES_H
2  #define STUDENTTESTSCORES_H
3  #include <string>
4  using namespace std;
5
6  const double DEFAULT_SCORE = 0.0;
7
8  class StudentTestScores
9  {
10 private:
11     string studentName; // The student's name
12     double *testScores; // Points to array of
test scores
13     int numTestScores; // Number of test
scores
14
15     // Private member function to create an
16     // array of test scores.
17     void createTestScoresArray(int size)
18     { numTestScores = size;
19       testScores = new double[size];
20       for (int i = 0; i < size; i++)
```

```
21         testScores[i] = DEFAULT_SCORE;}
22
23     public:
24         // Constructor
25         StudentTestScores(string name, int
numScores)
26         { studentName = name;
27           createTestScoresArray(numScores); }
28
29         // Destructor
30         ~StudentTestScores()
31         { delete [] testScores; }
32
33         // The setTestScore function sets a
specific
34         // test score's value.
35         void setTestScore(double score, int index)
36         { testScores[index] = score; }
37
38         // Set the student's name.
39         void setStudentName(string name)
40         { studentName = name; }
41
42         // Get the student's name.
43         string getStudentName() const
44         { return studentName; }
45
```

```

46     // Get the number of test scores.
47     int getNumTestScores() const
48     { return numTestScores; }
49
50     // Get a specific test score.
51     double getTestScore(int index) const
52     { return testScores[index]; }
53 };
54 #endif

```

This class stores a student's name and a set of test scores. Let's take a closer look at the code:

- Lines 11 through 13 declare the class's attributes. The `studentName` attribute is a string object that holds a student's name. The `testScores` attribute is an int pointer. Its purpose is to point to a dynamically allocated int array that holds the student's test score. The `numTestScore` attribute is an int that holds the number of test scores.
- The `createTestScoresArray` private member function, in lines 17 through 21, creates an array to hold the student's test scores. It accepts an argument for the number of test scores, assigns this value to the `numTestScores` attribute (line 18), then dynamically allocates an int array for the `testScores` attribute (line 19). The for

loop in lines 20 and 21 initializes each element of the array to the default value 0.0.

- The constructor, in lines 25 through 27, accepts the student's name and the number of test scores as arguments. In line 26, the name is assigned to the `studentName` attribute, and in line 27 the number of test scores is passed to the `createTestScoresArray` member function.
- The destructor, in lines 30 and 31, deallocates the `testScores` array.
- The `setTestScore` member function, in lines 35 and 36, sets a specific score in the `testScores` attribute. The function accepts arguments for the score and the index where the score should be stored in the `testScores` array.
- The `setStudentName` member function, in lines 39 and 40, accepts an argument that is assigned to the `studentName` attribute.
- The `getStudentName` member function, in lines 43 and 44, returns the value of the `studentName` attribute.
- The `getNumTestScores` member function, in lines 47 and 48, returns the number of test scores stored in the object.
- The `getTestScore` member function, in lines 51 and 52, returns a specific score (specified by the index parameter) from the `testScores` attribute.

A potential problem with this class lies in the fact that one of its members, `testScores`, is a pointer. The `createTestScoresArray` member function (called by the constructor) performs a critical

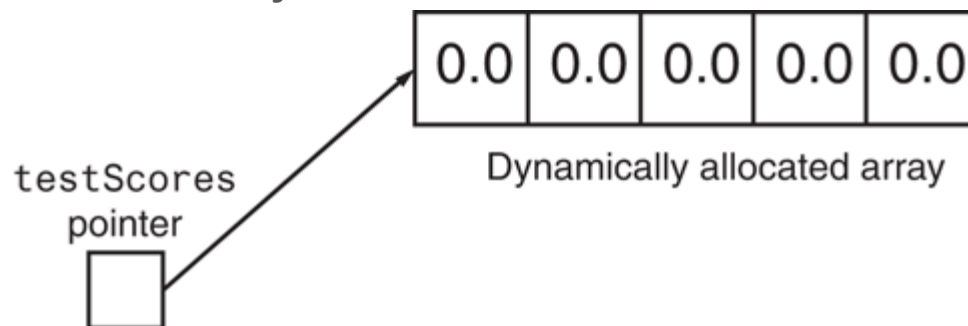


operation with the pointer: It dynamically allocates a section of memory for the `testScores` array and assigns default values to each of its element. For instance, the following statement creates a `StudentTestScores` object named `student1`, whose `testScores` member references dynamically allocated memory holding an array of 5 `double`'s:

```
StudentTestScores("Maria Jones Tucker", 5);
```

This is depicted in [Figure 14-3](#).

**Figure 14-3** The `testScores` member referencing a dynamically allocated array

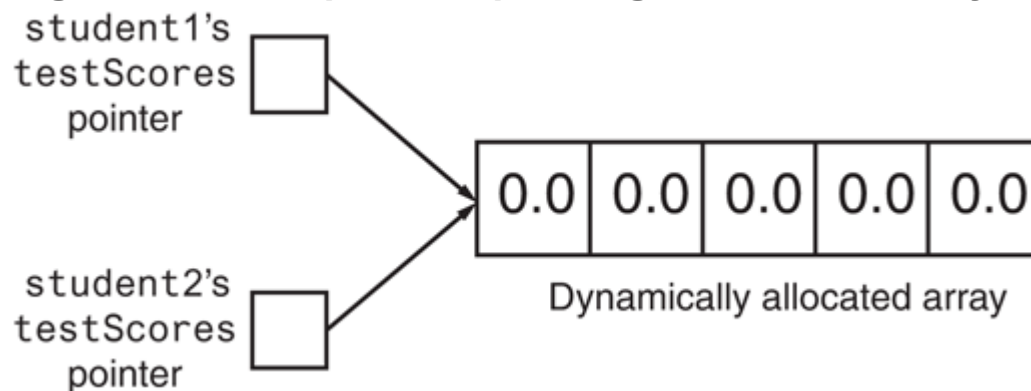


Consider what happens when another `StudentTestScores` object is created and initialized with the `student1` object, as in the following statement:

```
StudentTestScores student2 = student1;
```

In the statement above, `student2`'s constructor isn't called. Instead, memberwise assignment takes place, copying each of `student1`'s member variables into `student2`. This means that a separate section of memory is not allocated for `student2`'s `testScores` member. It simply gets a copy of the address stored in `student1`'s `testScores` member. Both pointers will point to the same address, as depicted in [Figure 14-4](#).

**Figure 14-4** Two pointers pointing to the same array



In this situation, either object can manipulate the values stored in the array, causing the changes to show up in the other object. Likewise, one object can be destroyed, causing its destructor to be called, which frees the allocated memory. The remaining object's `testScores` pointer would still reference this section of memory, although it should no longer be used.

The solution to this problem is to create a *copy constructor* for the object. A copy constructor is a special constructor that's called when an object is initialized with another object's data. It has the same form as other constructors, except it has a reference parameter of

the same class type as the object itself. For example, here is a copy constructor for the `StudentTestScores` class:

```
StudentTestScores(StudentTestScores &obj)
{
    studentName = obj.studentName;
    numTestScores = obj.numTestScores;
    testScores = new double[numTestScores];
    for (int i = 0; i < length; i++)
        testScores[i] = obj.testScores[i];
}
```

When the `=` operator is used to initialize a `StudentTestScores` object with the contents of another `StudentTestScores` object, the copy constructor is called. The `StudentTestScores` object that appears on the right side of the `=` operator is passed as an argument to the copy constructor. For example, look at the following statement:

```
StudentTestScores student1 ("Molly McBride", 8);
StudentTestScores student2 = student1;
```

In this code, the `student1` object is passed as an argument to the `student2` object's copy constructor.



## Note:

C++ requires that a copy constructor's parameter be a reference object.

As you can see from studying the copy constructor's code, `student2`'s `testScores` member will properly reference its own dynamically allocated memory. There will be no danger of `student1` inadvertently destroying or corrupting `student2`'s data.

# Using `const` Parameters in Copy Constructors

Because copy constructors are required to use reference parameters, they have access to their argument's data. Since the purpose of a copy constructor is to make a copy of the argument, there is no reason the constructor should modify the argument's data. With this in mind, it's a good idea to make copy constructors' parameters constant by specifying the `const` key word in the parameter list. Here is an example:

```
StudentTestScores(const StudentTestScores &obj)
{
    studentName = obj.studentName;
    numTestScores = obj.numTestScores;
    testScores = new double[numTestScores];
    for (int i = 0; i < numTestScores; i++)
        testScores[i] = obj.testScores[i];
}
```

The `const` key word ensures that the function cannot change the contents of the parameter. This will prevent you from inadvertently writing code that corrupts data.

The complete listing for the revised `StudentTestScores` class is shown here. (This file can be found in the Student Source Code

Folder **Chapter 14**  \StudentTestScores Version 2.)

## Contents of `StudentTestScores.h` (Version 2)

```
1  #ifndef STUDENTTESTSCORES_H
2  #define STUDENTTESTSCORES_H
3  #include <string>
4  using namespace std;
5
6  const double DEFAULT_SCORE = 0.0;
7
8  class StudentTestScores
9  {
10 private:
11     string studentName; // The student's name
12     double *testScores; // Points to array of
test scores
13     int numTestScores; // Number of test
scores
14
15     // Private member function to create an
16     // array of test scores.
17     void createTestScoresArray(int size)
18     { numTestScores = size;
19       testScores = new double[size];
20       for (int i = 0; i < size; i++)
```

```
21         testScores[i] = DEFAULT_SCORE; }
22
23     public:
24         // Constructor
25         StudentTestScores(string name, int
numScores)
26         { studentName = name;
27           createTestScoresArray(numScores); }
28
29         // Copy constructor
30         StudentTestScores(const StudentTestScores
&obj)
31         { studentName = obj.studentName;
32           numTestScores = obj.numTestScores;
33           testScores = new double[numTestScores];
34           for (int i = 0; i < numTestScores; i++)
35             testScores[i] = obj.testScores[i]; }
36
37         // Destructor
38         ~StudentTestScores()
39         { delete [] testScores; }
40
41         // The setTestScore function sets a
specific
42         // test score's value.
43         void setTestScore(double score, int index)
44         { testScores[index] = score; }
```



```
45
46     // Set the student's name.
47     void setStudentName(string name)
48     { studentName = name; }
49
50     // Get the student's name.
51     string getStudentName() const
52     { return studentName; }
53
54     // Get the number of test scores.
55     int getNumTestScores() const
56     { return numTestScores; }
57
58     // Get a specific test score.
59     double getTestScore(int index) const
60     { return testScores[index]; }
61 };
62 #endif
```

# Copy Constructors and Function Parameters

When a class object is passed by value as an argument to a function, it is passed to a parameter that is also a class object, and the copy constructor of the function's parameter is called. Remember that when a nonreference class object is used as a function parameter, it is created when the function is called, and it is initialized with the argument's value.

This is why C++ requires the parameter of a copy constructor to be a reference object. If an object were passed to the copy constructor by value, the copy constructor would create a copy of the argument and store it in the parameter object. When the parameter object is created, its copy constructor will be called, thus causing another parameter object to be created. This process will continue indefinitely (or at least until the available memory fills up, causing the program to halt).

To prevent the copy constructor from calling itself an infinite number of times, C++ requires its parameter to be a reference object.

# The Default Copy Constructor

Although you may not realize it, you have seen the action of a copy constructor before. If a class doesn't have a copy constructor, C++ creates a *default copy constructor* for it. The default copy constructor performs the memberwise assignment discussed in the previous section.



## Checkpoint

- 14.8 Briefly describe what is meant by memberwise assignment.
- 14.9 Describe two instances when memberwise assignment occurs.
- 14.10 Describe a situation in which memberwise assignment should not be used.
- 14.11 When is a copy constructor called?
- 14.12 How does the compiler know that a member function is a copy constructor?
- 14.13 What action is performed by a class's default copy constructor?

# 14.5 Operator Overloading

## Concept:

C++ allows you to redefine how standard operators work when used with class objects.



## Operator Overloading

C++ provides many operators to manipulate data of the primitive data types. However, what if you wish to use an operator to manipulate class objects? For example, assume that a class named `Date` exists, and objects of the `Date` class hold the month, day, and year in member variables. Suppose the `Date` class has a member function named `add`. The `add` member function adds a number of days to the date and adjusts the member variables if the date goes

to another month or year. For example, the following statement adds 5 days to the date stored in the `today` object:

```
today.add(5);
```

Although it might be obvious that the statement is adding 5 days to the date stored in `today`, the use of an operator might be more intuitive. For example, look at the following statement:

```
today += 5;
```

This statement uses the standard `+=` operator to add 5 to `today`. This behavior does not happen automatically, however. The `+=` operator must be *overloaded* for this action to occur. In this section, you will learn to overload many of C++'s operators to perform specialized operations on class objects.



## Note:

You have already experienced the behavior of an overloaded operator. The `/` operator performs two types of division: floating-point and integer. If one of the `/` operator's operands is a floating-point type, the result will be a floating-point value. If both of the `/` operator's operands are integers, however, a different behavior occurs: the result is an integer, and any fractional part is thrown away.

# The `this` Pointer

Before going any further with our discussion of operator overloading, we need to discuss a special pointer named `this`. The `this` pointer is a built-in pointer that every class has. It is passed as a hidden argument to all nonstatic member functions, and it always points to the instance of the class making the function call. For example, if `student1` and `student2` are both `StudentTestScores` objects, the following statement causes the `getStudentName` member function to operate on `student1`:

```
cout << student1.getStudentName() << endl;
```

Likewise, the following statement causes `getStudentName` to operate on `student2`:

```
cout << student2.getStudentName() << endl;
```

When `getStudentName` is operating on `student1`, the `this` pointer is pointing to `student1`. When `getStudentName` is operating on `student2`, the `this` pointer is pointing to `student2`. The `this` pointer always points to the object that is being used to call the member function.

# Overloading the = Operator

Although copy constructors solve the initialization problems inherent with objects containing pointer members, they do not work with simple assignment statements. Copy constructors are just that—constructors. They are invoked only when an object is created. Statements like the following still perform memberwise assignment:

```
student2 = student1;
```

In order to change the way the assignment operator works, it must be overloaded. Operator overloading permits you to redefine an existing operator's behavior when used with a class object.

C++ allows a class to have special member functions called *operator functions*. If you wish to redefine the way a particular operator works with an object, you define a function for that operator. The operator function is then executed any time the operator is used with an object of that class. Let's look at how we might overload the = operator in the `StudentTestScores` class. If you go to this book's Student Source Code Folder named [Chapter 14](#) \StudentTestScores version 3 and open the `StudentTestScores.h` file, you will find that inside the class, in lines 63 through 74, we have added the following member function:



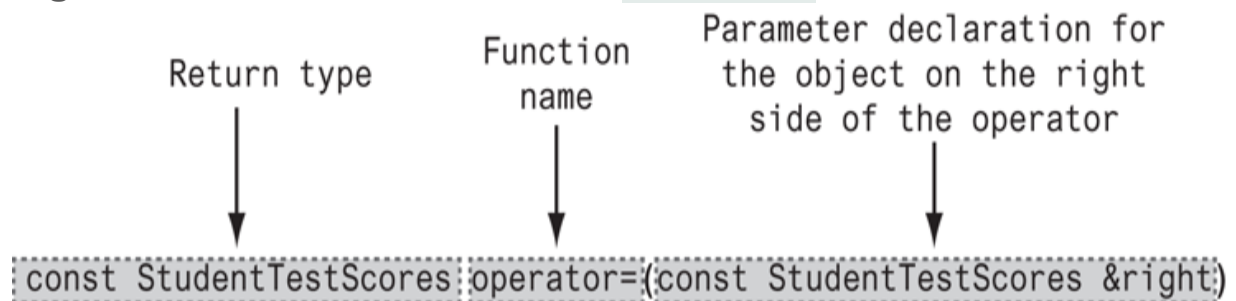
```

62 // Overloaded = operator
63 const StudentTestScores operator=(const StudentTestScores
&right)
64 { if (this != &right)
65     {
66         delete[] testScores;
67         studentName = right.studentName;
68         numTestScores = right.numTestScores;
69         testScores = new double[numTestScores];
70         for (int i = 0; i < numTestScores; i++)
71             testScores[i] = right.testScores[i];
72     }
73     return *this;
74 }

```

Let's examine the operator function to understand how it works. First, let's dissect the function header, in line 63, into the three parts shown in [Figure 14-5](#).

**Figure 14-5** Function header for `operator=`



- **Return type:** The function's return type is `const StudentTestScores`. This means that it returns a `StudentTestScores` object that is `const` (it cannot be modified). We will discuss this in greater detail in a moment.
- **Function name:** The function's name is `operator=`. This specifies that the function overloads the `=` operator. Because it is a member of the `StudentTestScores` class, this function will be called when an assignment statement executes where the object on the left side of the `=` operator is a `StudentTestScores` object.
- **Parameter declaration:** The function has one parameter: a constant reference object named `right`. This parameter references the object on the right side of the operator. For example, when the following statement is executed, `right` will reference the `student1` object:

```
student2 = student1;
```

We declared the `right` parameter as a reference variable for efficiency purposes. This prevents the compiler from making a copy of the object that is being passed into the function. We declared it `const`, so the function will not accidentally change its contents.



## Note:

In the example, the parameter was named `right` simply to illustrate that it references the object on the right side of the operator. You can name the parameter anything you wish. It will always take the object on the operator's right as its argument.

In learning the mechanics of operator overloading, it is helpful to know that the following two statements do the same thing:

```
student2 = student1;           // Call operator= function
student2.operator=(student1); // Call operator= function
```

In the second statement, you can see exactly what is going on in the function call. The `student1` object is being passed to the function's parameter, `right`. Inside the function, the values in `right`'s members are used to initialize `student2`. Notice the `operator=` function has access to the `right` parameter's private members. Because the `operator=` function is a member of the `StudentTestScores` class, it has access to the private members of any `StudentTestScores` object that is passed into it.

# Checking for Self-Assignment

Recall that `this` is a hidden argument that is passed to all nonstatic member functions. `this` is a special pointer that points to the object that called the function. Inside our `operator=` function, `this` will point to the object that is on the left side of the `=` sign, and `right` will reference the object on the right side of the `=` sign. This is illustrated in [Figure 14-6](#). In the figure, assume that `student1` and `student2` are both `StudentTestScores` objects.

**Figure 14-6** The `this` pointer and the `right` parameter

```
student1 = student2;
```

The diagram shows the code `student1 = student2;` with two arrows pointing upwards. The arrow under `student1` is labeled `this`, and the arrow under `student2` is labeled `right`.

Look back at the `operator=` function, and notice the first statement inside the body of the function (line 64) is an `if` statement that starts like this:

```
if (this != &right)
```

This `if` statement is making sure the address stored in `this` is not the same as the address of the `right` object. In other words, it is checking for self-assignment. Self-assignment occurs when you

assign an object to itself. For example, assume `student1` is a `StudentTestScores` object, and it holds a set of test scores. The following statement performs self-assignment:

```
student1 = student1;
```

Obviously, there is no reason to write a statement like this, but, in programs that work with pointers and references to objects, such assignments can happen in a roundabout way. It is important that you write code in your `operator=` functions to check for self-assignment, especially in classes that dynamically allocate memory. For example, the following code fragment shows how the `operator=` member function of the `StudentTestScores` class would look if we did not check for self-assignment:

```
// Overloaded = operator that does not check for self-
assignment
const StudentTestScores operator=(const StudentTestScores
&right)
{ delete[] testScores;
  studentName = right.studentName;
  numTestScores = right.numTestScores;
  testScores = new double[numTestScores];
  for (int i = 0; i < numTestScores; i++)
    testScores[i] = right.testScores[i];
  return *this;
}
```

In this version of the function, the first thing we do is delete the memory for the `testScores` array. In the event of self-assignment, this will be a problem because we are deleting the memory from which we will be copying! Obviously, the assignment will not work as intended. The corrected version of the function, shown again here, avoids the problem by skipping all of the assignment steps when self-assignment has been detected:

```
62 // Overloaded = operator
63 const StudentTestScores operator=(const StudentTestScores
&right)
64 { if (this != &right)
65     {
66         delete[] testScores;
67         studentName = right.studentName;
68         numTestScores = right.numTestScores;
69         testScores = new double[numTestScores];
70         for (int i = 0; i < numTestScores; i++)
71             testScores[i] = right.testScores[i];
72     }
73     return *this;
74 }
```

# The `=` Operator's Return Value

The last thing we need to discuss about the `operator=` function is its return value. Recall that C++'s built-in `=` operator allows multiple assignment statements such as:

```
a = b = c = d;
```

This statement works in the following way:

- The expression `c = d` assigns `d` to `c`, then returns the new value of `c`.
- The new value of `c`, which is returned from the previous expression is assigned to `b`, then the new value of `b` is returned.
- The new value of `b`, which is returned from the previous expression, is assigned to `a`.

If a class object's overloaded `=` operator is to function this way, it too must return the value of the object that received the assignment.

That's why the `operator=` function in the `StudentTestScores` class has a return type of `const StudentTestScores`, and the last statement in the function is:





```
return *this;
```

The expression `*this` dereferences the `this` pointer, giving us the actual object that received the assignment. A `const` copy of that object is then returned.

# Copy Assignment

The overloaded `=` operator that we just looked at is an example of a *copy assignment operator*. It is called a copy assignment operator because it copies data from one object to another. Later in this chapter, you will see an example of another type of assignment known as *move assignment*.

**Program 14-6**  demonstrates the `StudentTestScores` class with its overloaded assignment operator. (This file can be found in the Student Source Code Folder **Chapter 14**  \StudentTestScores Version 3.)

## Program 14-6

```
1 // This program demonstrates the overloaded =
operator
2 #include <iostream>
3 #include "StudentTestScores.h"
4 using namespace std;
5
6 // Function prototype
7 void displayStudent(StudentTestScores);
8
9 int main()
10 {
11     // Create a StudentTestScores object and
12     // assign test scores.
13     StudentTestScores student1("Kelly
Thorton", 3);
14     student1.setTestScore(100.0, 0);
15     student1.setTestScore(95.0, 1);
16     student1.setTestScore(80, 2);
17
18     // Create another StudentTestScore object
19     // with default test scores.
20     StudentTestScores student2("Jimmy
Griffin", 5);
```



```

21
22     // Assign the student1 object to student2
23     student2 = student1;
24
25     // Display both objects. They should
26     // contain the same data.
27     displayStudent(student1);
28     displayStudent(student2);
29     return 0;
30 }
31
32 // The displayStudent function accepts a
33 // StudentTestScores object's data.
34 void displayStudent(StudentTestScores s)
35 {
36     cout << "Name: " << s.getStudentName() <<
endl;
37     cout << "Test Scores: ";
38     for (int i = 0; i < s.getNumTestScores();
i++)
39         cout << s.getTestScore(i) << " ";
40     cout << endl;
41 }

```

## Program Output

```
Name: Kelly Thorton
Test Scores: 100 95 80
Name: Kelly Thorton
Test Scores: 100 95 80
```

The overloaded = operator function is demonstrated again in **Program 14-7** . The multiple assignment statement in line 22 causes the `operator=` function to execute. (This file and the revised version of the `StudentTestScores` class can be found in the Student Source Code Folder **Chapter 14**  StudentTestScores Version 4.)

## Program 14-7

```
1 // This program demonstrates the overloaded =
operator returning a value.
2 #include <iostream>
3 #include "StudentTestScores.h"
4 using namespace std;
5
6 // Function prototype
7 void displayStudent(StudentTestScores);
8
9 int main()
10 {
11     // Create a StudentTestScores object.
12     StudentTestScores student1("Kelly
Thorton", 3);
13     student1.setTestScore(100.0, 0);
14     student1.setTestScore(95.0, 1);
15     student1.setTestScore(80, 2);
16
17     // Create two more StudentTestScores
objects.
18     StudentTestScores student2("Jimmy
Griffin", 5);
19     StudentTestScores student3("Kristen Lee",
```

```

10);
20
21     // Assign student1 to student2 and
student3.
22     student3 = student2 = student1;
23
24     // Display the objects.
25     displayStudent(student1);
26     displayStudent(student2);
27     displayStudent(student3);
28     return 0;
29 }
30
31 // displayStudent function
32 void displayStudent(StudentTestScores s)
33 {
34     cout << "Name: " << s.getStudentName() <<
endl;
35     cout << "Test Scores: ";
36     for (int i = 0; i < s.getNumTestScores();
i++)
37         cout << s.getTestScore(i) << " ";
38     cout << endl;
39 }

```

## Program Output

Name: Kelly Thorton

Test Scores: 100 95 80

Name: Kelly Thorton

Test Scores: 100 95 80

Name: Kelly Thorton

Test Scores: 100 95 80



# Some General Issues of Operator Overloading

Now that you have had a taste of operator overloading, let's look at some of the general issues involved in this programming technique.

Although it is not a good programming practice, you can change an operator's entire meaning if that's what you wish to do. There is nothing to prevent you from changing the = symbol from an assignment operator to a "display" operator. For instance, the following class does just that:

```
class Weird
{
private:
    int value;
public:
    Weird(int v)
        { value = v; }
    void operator=(const weird &right) const
        { cout << right.value << endl; }
};
```

Although the `operator=` function in the `Weird` class overloads the assignment operator, the function doesn't perform an assignment. Instead, it displays the contents of `right.value`. Consider the following program segment:

```
Weird a(5), b(10);  
a = b;
```

Although the statement `a = b` looks like an assignment statement, it actually causes the contents of `b`'s `value` member to be displayed on the screen:

```
10
```

Another operator overloading issue is you cannot change the number of operands taken by an operator. The `=` symbol must always be a binary operator. Likewise, `++` and `--` must always be unary operators.

The last issue is although you may overload most of the C++ operators, you cannot overload all of them. [Table 14-1](#) shows all of the C++ operators that may be overloaded (some of the operators shown in the table are beyond the scope of this book and are not discussed).

## Table 14-1 Operators that May Be Overloaded

The only operators that cannot be overloaded are

```
?: . .* :: sizeof
```

# Overloading Math Operators

Many classes would benefit not only from an overloaded assignment operator, but also from overloaded math operators. To illustrate this, consider the `FeetInches` class shown in the following two files.

(These files can be found in the Student Source Code Folder

**Chapter 14**  FeetInches Version 1.)

## Contents of `FeetInches.h` (Version 1)

```
1  #ifndef FEETINCHES_H
2  #define FEETINCHES_H
3
4  // The FeetInches class holds distances or
measurements
5  // expressed in feet and inches.
6
7  class FeetInches
8  {
9  private:
10     int feet;          // To hold a number of
feet
11     int inches;       // To hold a number of
inches
12     void simplify(); // Defined in
FeetInches.cpp
13 public:
14     // Constructor
15     FeetInches(int f = 0, int i = 0)
16     { feet = f;
17       inches = i;
18       simplify(); }
19
```

```
20     // Mutator functions
21     void setFeet(int f)
22         { feet = f; }
23
24     void setInches(int i)
25         { inches = i;
26           simplify(); }
27
28     // Accessor functions
29     int getFeet() const
30         { return feet; }
31
32     int getInches() const
33         { return inches; }
34
35     // Overloaded operator functions
36     FeetInches operator + (const FeetInches
37 &); // Overloaded +
38
39     FeetInches operator - (const FeetInches
40 &); // Overloaded -
41 };
42
43 #endif
```

## Contents of `FeetInches.cpp` (Version 1)

```
1 // Implementation file for the FeetInches
class
2 #include <cstdlib> // Needed for abs()
3 #include "FeetInches.h"
4
5
//*****
*****
6 // Definition of member function simplify.
This function *
7 // checks for values in the inches member
greater than *
8 // twelve or less than zero. If such a value
is found, *
9 // the numbers in feet and inches are adjusted
to conform *
10 // to a standard feet & inches expression. For
example, *
11 // 3 feet 14 inches would be adjusted to 4
feet 2 inches and *
12 // 5 feet -2 inches would be adjusted to 4
feet 10 inches. *
13
```

```

14
15 void FeetInches::simplify()
16 {
17     if (inches >= 12)
18     {
19         feet += (inches / 12);
20         inches = inches % 12;
21     }
22     else if (inches < 0)
23     {
24         feet -= ((abs(inches) / 12) + 1);
25         inches = 12 - (abs(inches) % 12);
26     }
27 }
28
29
30 // Overloaded binary + operator.
31 *
32 //
33 FeetInches FeetInches::operator + (const
FeetInches &right)
34 {

```



```
35     FeetInches temp;
36
37     temp.inches = inches + right.inches;
38     temp.feet = feet + right.feet;
39     temp.simplify();
40     return temp;
41 }
42
43
44 //*****
45 // Overloaded binary - operator.
46 *
47 //*****
48
49 FeetInches FeetInches::operator - (const
FeetInches &right)
50 {
51     FeetInches temp;
52
53     temp.inches = inches - right.inches;
54     temp.feet = feet - right.feet;
55     temp.simplify();
56     return temp;
57 }
```

The `FeetInches` class is designed to hold distances or measurements expressed in feet and inches. It consists of eight member functions:

- A constructor that allows the `feet` and `inches` members to be set. The default values for these members is zero.
- `setFeet`—a function for storing a value in the `feet` member
- `setInches`—a function for storing a value in the `inches` member
- `getFeet`—a function for returning the value in the `feet` member
- `getInches`—a function for returning the value in the `inches` member
- `simplify`—a function for normalizing the values held in `feet` and `inches`. This function adjusts any set of values where the `inches` member is greater than 12 or less than 0.
- `operator +`—a function that overloads the standard + math operator
- `operator -`—a function that overloads the standard - math operator



## Note:

The `simplify` function uses the standard library function `abs()` to get the absolute value of the `inches` member. The `abs()` function requires that `cstdlib` be included.

The overloaded `+` and `-` operators allow one `FeetInches` object to be added to or subtracted from another. For example, assume the `length1` and `length2` objects are defined and initialized as follows:

```
FeetInches length1(3, 5), length2(6, 3);
```

The `length1` object is holding the value 3 feet 5 inches, and the `length2` object is holding the value 6 feet 3 inches. Because the `+` operator is overloaded, we can add these two objects in a statement such as:

```
length3 = length1 + length2;
```

This statement will add the values of the `length1` and `length2` objects and store the result in the `length3` object. After the

statement executes, the `length3` object will be set to 9 feet 8 inches.

The member function that overloads the `+` operator appears in lines 33 through 41 of the `FeetInches.cpp` file.

This function is called anytime the `+` operator is used with two `FeetInches` objects. Just like the overloaded `=` operator we defined in the previous section, this function has one parameter: a constant reference object named `right`. This parameter references the object on the right side of the operator. For example, when the following statement is executed, `right` will reference the `length2` object:

```
length3 = length1 + length2;
```

As before, it might be helpful to think of the statement above as the following function call:

```
length3 = length1.operator+(length2);
```

The `length2` object is being passed to the function's parameter, `right`. When the function finishes, it will return a `FeetInches` object to `length3`. Now let's see what is happening inside the function.

First, notice a `FeetInches` object named `temp` is defined locally in line 35:

```
FeetInches temp;
```

This object is a temporary location for holding the results of the addition. Next, line 37 adds `inches` to `right.inches` and stores the result in `temp.inches`:

```
temp.inches = inches + right.inches;
```

The `inches` variable is a member of `length1`, the object making the function call. It is the object on the left side of the operator. `right.inches` references the `inches` member of `length2`. The next statement, in line 38, is very similar. It adds `feet` to `right.feet` and stores the result in `temp.feet`.

```
temp.feet = feet + right.feet;
```

At this point in the function, `temp` contains the sum of the `feet` and `inches` members of both objects in the expression. The next step is to adjust the values, so they conform to a normal value expressed in

feet and inches. This is accomplished in line 39 by calling

```
temp.simplify():
```

```
temp.simplify();
```

The last step, in line 40, is to return the value stored in `temp`:

```
return temp;
```

In the statement `length3 = length1 + length2`, the `return` statement in the operator function causes the values stored in `temp` to be returned to the `length3` object.

**Program 14-8** [□](#) demonstrates the overloaded operators. (This file can be found in the Student Source Code Folder **Chapter 14** [□](#) \FeetInches Version 1.)

## Program 14-8

```
1 // This program demonstrates the FeetInches
class's overloaded
2 // + and - operators.
3 #include <iostream>
4 #include "FeetInches.h"
5 using namespace std;
6
7 int main()
8 {
9     int feet, inches; // To hold input for
feet and inches
10
11     // Create three FeetInches objects. The
default arguments
12     // for the constructor will be used.
13     FeetInches first, second, third;
14
15     // Get a distance from the user.
16     cout << "Enter a distance in feet and
inches: ";
17     cin >> feet >> inches;
18
19     // Store the distance in the first object.
```

```
20     first.setFeet(feet);
21     first.setInches(inches);
22
23     // Get another distance from the user.
24     cout << "Enter another distance in feet
and inches: ";
25     cin >> feet >> inches;
26
27     // Store the distance in second.
28     second.setFeet(feet);
29     second.setInches(inches);
30
31     // Assign first + second to third.
32     third = first + second;
33
34     // Display the result.
35     cout << "first + second = ";
36     cout << third.getFeet() << " feet, ";
37     cout << third.getInches() << " inches.\n";
38
39     // Assign first - second to third.
40     third = first - second;
41
42     // Display the result.
43     cout << "first - second = ";
44     cout << third.getFeet() << " feet, ";
45     cout << third.getInches() << " inches.\n";
```



```
46
47     return 0;
48 }
```

### Program Output with Example Input Shown in Bold

```
Enter a distance in feet and inches: 6 5
Enter
Enter another distance in feet and inches: 3
10 Enter
first + second = 10 feet, 3 inches.
first - second = 2 feet, 7 inches.
```

# Overloading the Prefix ++ Operator

Unary operators, such as ++ and --, are overloaded in a fashion similar to the way binary operators are implemented. Because unary operators only affect the object making the operator function call, however, there is no need for a parameter. For example, let's say you wish to have a prefix increment operator for the `FeetInches` class. Assume the `FeetInches` object `distance` is set to the values 7 feet and 5 inches. A ++ operator function could be designed to increment the object's `inches` member. The following statement would cause `distance` to have the value 7 feet 6 inches:

```
++distance;
```

The following function overloads the prefix ++ operator to work in this fashion:

```
FeetInches FeetInches::operator++()  
{  
    ++inches;  
    simplify();  
    return *this;  
}
```

This function first increments the object's `inches` member. The `simplify()` function is called then the dereferenced `this` pointer is returned. This allows the operator to perform properly in statements like this:

```
distance2 = ++distance1;
```

Remember, the statement above is equivalent to

```
distance2 = distance1.operator++();
```

# Overloading the Postfix ++ Operator

Overloading the postfix ++ operator is only slightly different than overloading the prefix version. Here is the function that overloads the postfix operator with the `FeetInches` class:

```
FeetInches FeetInches::operator++(int)
{
    FeetInches temp(feet, inches);
    inches++;
    simplify();
    return temp;
}
```

The first difference you will notice is the use of a *dummy parameter*. The word `int` in the function's parentheses establishes a nameless integer parameter. When C++ sees this parameter in an operator function, it knows the function is designed to be used in postfix mode. The second difference is the use of a temporary local variable, the `temp` object. `temp` is initialized with the `feet` and `inches` values of the object making the function call. `temp`, therefore, is a copy of the object being incremented, but before the increment takes place. After `inches` is incremented and the

`simplify` function is called, the contents of `temp` is returned. This causes the postfix operator to behave correctly in a statement like this:

```
distance2 = distance1++;
```

You will find a version of the `FeetInches` class with the overloaded prefix and postfix `++` operators in the Student Source Code Folder [Chapter 14](#) \FeetInches Version 2. In that folder, you will also find [Program 14-9](#), which demonstrates these overloaded operators.

## Program 14-9

```
1 // This program demonstrates the FeetInches
class's overloaded
2 // prefix and postfix ++ operators.
3 #include <iostream>
4 #include "FeetInches.h"
5 using namespace std;
6
7 int main()
8 {
9     int count; // Loop counter
10
11     // Define a FeetInches object with the
default
12     // value of 0 feet, 0 inches.
13     FeetInches first;
14
15     // Define a FeetInches object with 1 foot
5 inches.
16     FeetInches second(1, 5);
17
18     // Use the prefix ++ operator.
19     cout << "Demonstrating prefix ++
operator.\n";
```

```
20     for (count = 0; count < 12; count++)
21     {
22         first = ++second;
23         cout << "first: " << first.getFeet()
24         << " feet, ";
25         cout << first.getInches() << " inches.
26         ";
27         cout << "second: " << second.getFeet()
28         << " feet, ";
29         cout << second.getInches() << "
30         inches.\n";
31     }
32
33     // Use the postfix ++ operator.
34     cout << "\nDemonstrating postfix ++
35     operator.\n";
36     for (count = 0; count < 12; count++)
37     {
38         first = second++;
39         cout << "first: " << first.getFeet()
40         << " feet, ";
41         cout << first.getInches() << " inches.
42         ";
43         cout << "second: " << second.getFeet()
44         << " feet, ";
45         cout << second.getInches() << "
46         inches.\n";
```

```
38     }  
39  
40     return 0;  
41 }
```

## Program Output



Demonstrating prefix ++ operator.

first: 1 feet 6 inches. second: 1 feet 6 inches.

first: 1 feet 7 inches. second: 1 feet 7 inches.

first: 1 feet 8 inches. second: 1 feet 8 inches.

first: 1 feet 9 inches. second: 1 feet 9 inches.

first: 1 feet 10 inches. second: 1 feet 10 inches.

first: 1 feet 11 inches. second: 1 feet 11 inches.

first: 2 feet 0 inches. second: 2 feet 0 inches.

first: 2 feet 1 inches. second: 2 feet 1 inches.

first: 2 feet 2 inches. second: 2 feet 2 inches.

first: 2 feet 3 inches. second: 2 feet 3 inches.

first: 2 feet 4 inches. second: 2 feet 4 inches.

first: 2 feet 5 inches. second: 2 feet 5 inches.

Demonstrating postfix ++ operator.

first: 2 feet 5 inches. second: 2 feet 6 inches.

first: 2 feet 6 inches. second: 2 feet 7 inches.

first: 2 feet 7 inches. second: 2 feet 8 inches.

first: 2 feet 8 inches. second: 2 feet 9 inches.

first: 2 feet 9 inches. second: 2 feet 10 inches.

first: 2 feet 10 inches. second: 2 feet 11 inches.

first: 2 feet 11 inches. second: 3 feet 0 inches.

first: 3 feet 0 inches. second: 3 feet 1 inches.

first: 3 feet 1 inches. second: 3 feet 2 inches.

first: 3 feet 2 inches. second: 3 feet 3 inches.

first: 3 feet 3 inches. second: 3 feet 4 inches.

first: 3 feet 4 inches. second: 3 feet 5 inches.



## Checkpoint

14.14 Assume there is a class named `Pet`. Write the prototype for a member function of `Pet` that overloads the `=` operator.

14.15 Assume `dog` and `cat` are instances of the `Pet` class, which has overloaded the `=` operator. Rewrite the following statement so it appears in function call notation instead of operator notation:

```
dog = cat;
```

14.16 What is the disadvantage of an overloaded `=` operator returning `void`?

14.17 Describe the purpose of the `this` pointer.

14.18 The `this` pointer is automatically passed to what type of functions?

14.19 Assume there is a class named `Animal` that overloads the `=` and `+` operators. In the following statement, assume `cat`, `tiger`, and `wildcat` are all instances of the `Animal` class:

```
wildcat = cat + tiger;
```

Of the three objects, `wildcat`, `cat`, or `tiger`, which is calling the `operator+` function? Which object is passed as an

argument into the function?

14.20 What does the use of a dummy parameter in a unary operator function indicate to the compiler?

# Overloading Relational Operators

In addition to the assignment and math operators, relational operators may be overloaded. This capability allows classes to be compared in statements that use relational expressions such as:

```
if (distance1 < distance2)
{
    ... code ...
}
```

Overloaded relational operators are implemented like other binary operators. The only difference is that a relational operator function should always return a true or false value. The FeetInches class in the Student Source Code Folder [Chapter 14](#) \FeetInches Version 3 contains functions to overload the >, <, and == relational operators. Here is the function for overloading the > operator:

```
bool FeetInches::operator > (const FeetInches &right)
{
    bool status;
    if (feet > right.feet)
        status = true;
    else if (feet == right.feet && inches > right.inches)
        status = true;
    else
        status = false;
    return status;
}
```



As you can see, the function compares the `feet` member (and if necessary, the `inches` member) with that of the parameter. If the calling object contains a value greater than that of the parameter, `true` is returned. Otherwise, `false` is returned.

Here is the code that overloads the `<` operator:

```
bool FeetInches::operator < (const FeetInches &right)
{
    bool status;
    if (feet < right.feet)
        status = true;
    else if (feet == right.feet && inches < right.inches)
        status = true;
    else
        status = false;
    return status;
}
```

Here is the code that overloads the == operator:

```
bool FeetInches::operator == (const FeetInches &right)
{
    bool status;
    if (feet == right.feet && inches == right.inches)
        status = true;
    else
        status = false;
    return status;
}
```

**Program 14-10**  demonstrates these overloaded operators. (This file can also be found in the Student Source Code Folder **Chapter 14**  FeetInches Version 3.)



## Program 14-10

```
1 // This program demonstrates the FeetInches
class's overloaded
2 // relational operators.
3 #include <iostream>
4 #include "FeetInches.h"
5 using namespace std;
6
7 int main()
8 {
9     int feet, inches; // To hold input for
feet and inches
10
11     // Create two FeetInches objects. The
default arguments
12     // for the constructor will be used.
13     FeetInches first, second;
14
15     // Get a distance from the user.
16     cout << "Enter a distance in feet and
inches: ";
17     cin >> feet >> inches;
18
19     // Store the distance in first.
```

```
20     first.setFeet(feet);
21     first.setInches(inches);
22
23     // Get another distance.
24     cout << "Enter another distance in feet
and inches: ";
25     cin >> feet >> inches;
26
27     // Store the distance in second.
28     second.setFeet(feet);
29     second.setInches(inches);
30
31     // Compare the two objects.
32     if (first == second)
33         cout << "first is equal to second.\n";
34     if (first > second)
35         cout << "first is greater than
second.\n";
36     if (first < second)
37         cout << "first is less than
second.\n";
38
39     return 0;
40 }
```

**Program Output with Example Input Shown in Bold**

```
Enter a distance in feet and inches: 6 5
Enter
Enter another distance in feet and inches: 3
10 Enter
first is greater than second.
```

### **Program Output with Different Example Input Shown in Bold**

```
Enter a distance in feet and inches: 5 5
Enter
Enter another distance in feet and inches: 5
5 Enter
first is equal to second.
```

### **Program Output with Different Example Input Shown in Bold**

```
Enter a distance in feet and inches: 3 4
```

```
Enter
```

```
Enter another distance in feet and inches: 3
```

```
7 Enter
```

```
first is less than second.
```

# Overloading the << and >> Operators

Overloading the math and relational operators gives you the ability to write those types of expressions with class objects just as naturally as with integers, floats, and other built-in data types. If an object's primary data members are private, however, you still have to make explicit member function calls to send their values to `cout`. For example, assume `distance` is a `FeetInches` object. The following statements display its internal values:

```
cout << distance.getFeet() << " feet, ";  
cout << distance.getInches() << "inches";
```

It is also necessary to explicitly call member functions to set a `FeetInches` object's data. For instance, the following statements set the `distance` object to user-specified values:

```
cout << "Enter a value in feet: ";  
cin >> f;  
distance.setFeet(f);  
cout << "Enter a value in inches: ";  
cin >> i;  
distance.setInches(i);
```

By overloading the stream insertion operator (`<<`), you could send the `distance` object to `cout`, as shown in the following code, and have the screen output automatically formatted in the correct way:

```
cout << distance;
```

Likewise, by overloading the stream extraction operator (`>>`), the `distance` object could take values directly from `cin`, as shown here:

```
cin >> distance;
```

Overloading these operators is done in a slightly different way, however, than overloading other operators. These operators are actually part of the `ostream` and `istream` classes defined in the C++ runtime library. (The `cout` and `cin` objects are instances of

`ostream` and `istream`.) You must write operator functions to overload the `ostream` version of `<<` and the `istream` version of `>>`, so they work directly with a class such as `FeetInches`. The `FeetInches` class in the Student Source Code Folder **Chapter 14** `FeetInches` Version 4 contains functions to overload the `<<` and `>>` operators. Here is the function that overloads the `<<` operator:

```
ostream &operator << (ostream &strm, const FeetInches &obj)
{
    strm << obj.feet << " feet, " << obj.inches << " inches";
    return strm;
}
```

Notice the function has two parameters: an `ostream` reference object and a `const FeetInches` reference object. The `ostream` parameter will be a reference to the actual `ostream` object on the left side of the `<<` operator. The second parameter is a reference to a `FeetInches` object. This parameter will reference the object on the right side of the `<<` operator. This function tells C++ how to handle any expression that has the following form:

```
ostreamObject << FeetInchesObject
```

So, when C++ encounters the following statement, it will call the overloaded `operator<<` function:

```
cout << distance;
```

Notice the function's return type is `ostream &`. This means the function returns a reference to an `ostream` object. When the `return strm;` statement executes, it doesn't return a copy of `strm`, but a reference to it. This allows you to chain together several expressions using the overloaded `<<` operator, such as:

```
cout << distance1 << " " << distance2 << endl;
```

Here is the function that overloads the stream extraction operator to work with the `FeetInches` class:



```

istream &operator >> (istream &strm, FeetInches &obj)
{
    // Prompt the user for the feet.
    cout << "Feet: ";
    strm >> obj.feet;

    // Prompt the user for the inches.
    cout << "Inches: ";
    strm >> obj.inches;

    // Normalize the values.
    obj.simplify();
    return strm;
}

```

The same principles hold true for this operator. It tells C++ how to handle any expression in the following form:

```

istreamObject >> FeetInchesObject

```

Once again, the function returns a reference to an `istream` object, so several of these expressions may be chained together.

You have probably realized that neither of these functions is quite ready to work, though. Both functions attempt to directly access the `FeetInches` object's private members. Because the functions aren't themselves members of the `FeetInches` class, they don't have this

type of access. The next step is to make the operator functions friends of `FeetInches`. This is shown in the following listing of the `FeetInches` class declaration. (This file can be found in the Student Source Code Folder [Chapter 14](#) \FeetInches Version 4.)



### **Note:**

Some compilers require you to prototype the `>>` and `<<` operator functions outside the class. For this reason, we have added the following statements to the `FeetInches.h` class specification file.

```
class FeetInches; // Forward
Declaration
// Function Prototypes for Overloaded Stream Operators
ostream &operator << (ostream &, const FeetInches &);
istream &operator >> (istream &, FeetInches &);
```

## Contents of `FeetInches.h` (Version 4)



```
1  #ifndef FEETINCHES_H
2  #define FEETINCHES_H
3
4  #include <iostream>
5  using namespace std;
6
7  class FeetInches; // Forward Declaration
8
9  // Function Prototypes for Overloaded Stream
Operators
10 ostream &operator << (ostream &, const
FeetInches &);
11 istream &operator >> (istream &, FeetInches
&);
12
13 // The FeetInches class holds distances or
measurements
14 // expressed in feet and inches.
15
16 class FeetInches
17 {
18 private:
19     int feet; // To hold a number of
```

```
feet
20     int inches;        // To hold a number of
inches
21     void simplify(); // Defined in
FeetInches.cpp
22     public:
23         // Constructor
24         FeetInches(int f = 0, int i = 0)
25             { feet = f;
26               inches = i;
27               simplify(); }
28
29         // Mutator functions
30         void setFeet(int f)
31             { feet = f; }
32
33         void setInches(int i)
34             { inches = i;
35               simplify(); }
36
37         // Accessor functions
38         int getFeet() const
39             { return feet; }
40
41         int getInches() const
42             { return inches; }
43
```

```
44     // Overloaded operator functions
45     FeetInches operator + (const FeetInches
&); // Overloaded +
46     FeetInches operator - (const FeetInches
&); // Overloaded -
47     FeetInches operator ++ (); //
Prefix ++
48     FeetInches operator ++ (int); //
Postfix ++
49     bool operator > (const FeetInches &); //
Overloaded >
50     bool operator < (const FeetInches &); //
Overloaded <
51     bool operator == (const FeetInches &); //
Overloaded ==
52
53     // Friends
54     friend ostream &operator << (ostream &,
const FeetInches &);
55     friend istream &operator >> (istream &,
FeetInches &);
56 };
57
58 #endif
```

Lines 54 and 55 in the class declaration tell C++ to make the overloaded `<<` and `>>` operator functions friends of the `FeetInches` class:

```
friend ostream &operator<<(ostream &, const FeetInches &);  
friend istream &operator>>(istream &, FeetInches &);
```

These statements give the operator functions direct access to the `FeetInches` class's private members. [Program 14-11](#)  demonstrates how the overloaded operators work. (This file can also be found in the Student Source Code Folder [Chapter 14](#)  \FeetInches Version 4.)

## Program 14-11

```
1 // This program demonstrates the << and >>
operators,
2 // overloaded to work with the FeetInches
class.
3 #include <iostream>
4 #include "FeetInches.h"
5 using namespace std;
6
7 int main()
8 {
9     FeetInches first, second; // Define two
objects.
10
11     // Get a distance for the first object.
12     cout << "Enter a distance in feet and
inches.\n";
13     cin >> first;
14
15     // Get a distance for the second object.
16     cout << "Enter another distance in feet
and inches.\n";
17     cin >> second;
18
```

```
19 // Display the values in the objects.
20 cout << "The values you entered are:\n";
21 cout << first << " and " << second <<
endl;
22 return 0;
23 }
```

### Program Output with Example Input Shown in Bold

```
Enter a distance in feet and inches.
Feet: 6 Enter
Inches: 5 Enter
Enter another distance in feet and inches.
Feet: 3 Enter
Inches: 10 Enter
The values you entered are:
6 feet, 5 inches and 3 feet, 10 inches
```



# Overloading the [ ] Operator

In addition to the traditional operators, C++ allows you to change the way the `[]` symbols work. This gives you the ability to write classes that have array-like behaviors. For example, the `string` class overloads the `[]` operator, so you can access the individual characters stored in `string` class objects. Assume the following definition exists in a program:

```
string name = "William";
```

The first character in the string, 'W,' is stored at `name[0]`, so the following statement will display W on the screen.

```
cout << name[0];
```

You can use the overloaded `[]` operator to create an array class, like the following one. The class behaves like a regular array, but performs the bounds checking that C++ lacks.

## Contents of `IntArray.h`

```
1 // Specification file for the IntArray class
2 #ifndef INTARRAY_H
3 #define INTARRAY_H
4
5 class IntArray
6 {
7     private:
8         int *aptr;
9         // Pointer to the array
10        int arraySize;
11        // Holds the array size
12        void subscriptError();
13        // Handles invalid subscripts
14    public:
15        IntArray(int);
16        // Constructor
17        IntArray(const IntArray &);
18        // Copy constructor
19        ~IntArray();
20        // Destructor
21
22        int size() const;
23        // Returns the array size
```

```
17     { return arraySize; }
18
19     const IntArray operator=(const IntArray &);
// Overloaded = operator
20     int &operator[](const int &); //
Overloaded [] operator
21 };
22 #endif
```

## Contents of `IntArray.cpp`

```
1 // Implementation file for the IntArray class
2 #include <iostream>
3 #include <cstdlib> // For the exit function
4 #include "IntArray.h"
5 using namespace std;
6
7
8 //*****
9 // Constructor for IntArray class. Sets the
10 // size of the *
11 // array and allocates memory for it.
12 *
13 //*****
14
15 IntArray::IntArray(int s)
16 {
17     arraySize = s;
18     aptr = new int [s];
19     for (int count = 0; count < arraySize;
20         count++)
21         *(aptr + count) = 0;
```

```

17 }
18
19
//*****
*****
20 // Copy Constructor for IntArray class.
*
21
//*****
*****
22 IntArray::IntArray(const IntArray &obj)
23 {
24     arraySize = obj.arraySize;
25     aptr = new int [arraySize];
26     for(int count = 0; count < arraySize;
count++)
27         *(aptr + count) = *(obj.aptr + count);
28 }
29
30
//*****
*****
31 // Destructor for IntArray class.
*
32
//*****
*****

```

```

33  IntArray::~IntArray()
34  {
35      if (arraySize > 0)
36          delete [] aptr;
37  }
38
39
40  //*****
41  // subscriptError function. Displays an error
42  // message and *
43  // terminates the program when a subscript is
44  // out of range. *
45
46  //*****
47
48  void IntArray::subscriptError()
49  {
50      cout << "ERROR: Subscript out of range.\n";
51      exit(0);
52  }
53
54  //*****
55
56  // Overloaded = operator
57  *

```

```

51
//*****
*****
52  const IntArray IntArray::operator=(const
IntArray &right)
53  {
54      if (this != &right)
55      {
56          delete[] aptr;
57          arraySize = right.arraySize;
58          aptr = new int[arraySize];
59          for (int count = 0; count < arraySize;
count++)
60              *(aptr + count) = *(right.aptr +
count);
61      }
62      return *this;
63  }
64
65
//*****
*****
66  // Overloaded [] operator. The argument is a
subscript. *
67  // This function returns a reference to the
element *
68  // in the array indexed by the subscript.

```

```

*
69
//*****
*****
70 int &IntArray::operator[](const int &sub)
71 {
72     if (sub < 0 || sub >= arraySize)
73         subscriptError();
74     return aptr[sub];
75 }

```

Before focusing on the overloaded `[]` operator, let's look at the constructors and the destructor. The code for the first constructor in lines 11 through 17 of the `IntArray.cpp` file follows:

```

IntArray::IntArray(int s)
{
    arraySize = s;
    aptr = new int [s];
    for (int count = 0; count < arraySize; count++)
        *(aptr + count) = 0;
}

```



When an instance of the class is defined, the required number of elements is passed into the constructor's parameter, `s`. This value is assigned to the `arraySize` member, then used to dynamically allocate enough memory for the array. The constructor's final step is to store zeros in all of the array's elements.

The class also has a copy constructor in lines 22 through 28 which is used when a class object is initialized with another object's data:

```
IntArray::IntArray(const IntArray &obj)
{
    arraySize = obj.arraySize;
    aptr = new int [arraySize];
    for(int count = 0; count < arraySize; count++)
        *(aptr + count) = *(obj.aptr + count);
}
```

A reference to the initializing object is passed into the parameter `obj`. Once the memory is successfully allocated for the array, the constructor copies all the values in `obj`'s array into the calling object's array.

The destructor, in lines 33 through 37, simply frees the memory allocated by the class's constructors. First, however, it checks the value in `arraySize` to be sure the array has at least one element:

```
IntArray::~IntArray()  
{  
    if (arraySize > 0)  
        delete [] aptr;  
}
```

The `[]` operator is overloaded similarly to other operators. The definition of the `operator[]` function appears in lines 70 through 75:

```
int &IntArray::operator[](const int &sub)  
{  
    if (sub < 0 || sub >= arraySize)  
        subscriptError();  
    return aptr[sub];  
}
```

The `operator[]` function can have only a single parameter. The one shown uses a constant reference to an integer. This parameter holds the value placed inside the brackets in an expression. For example, if `table` is an `IntArray` object, the number 12 will be passed into the `sub` parameter in the following statement:

```
cout << table[12];
```

Inside the function, the value in the `sub` parameter is tested by the following `if` statement:

```
if (sub < 0 || sub >= arraySize)
    subscriptError();
```

This statement determines whether `sub` is within the range of the array's subscripts. If `sub` is less than 0, or greater than or equal to `arraySize`, it's not a valid subscript, so the `subscriptError` function is called. If `sub` is within range, the function uses it as an offset into the array and returns a reference to the value stored at that location.

One critically important aspect of the function above is its return type. It's crucial that the function return not simply an integer, but a *reference* to an integer. The reason for this is that expressions such as the following must be possible:

```
table[5] = 27;
```

Remember, the built-in `[]` operator requires the object on its left to be an lvalue. An lvalue must represent a modifiable memory location, such as a variable. The integer return value of a function is not an lvalue. If the `operator[]` function merely returns an integer, it

cannot be used to create expressions placed on the left side of an assignment operator.

A reference to an integer, however, is an lvalue. If the `operator[]` function returns a reference, it can be used to create expressions like the following:

```
table[7] = 52;
```

In this statement, the `operator[]` function is called with 7 passed as its argument. Assuming 7 is within range, the function returns a reference to the integer stored at `(aptr + 7)`. In essence, the statement above is equivalent to:

```
*(aptr + 7) = 52;
```

Because the `operator[]` function returns actual integers stored in the array, it is not necessary for math or relational operators to be overloaded. Even the stream operators `<<` and `>>` will work just as they are with the `IntArray` class.

**Program 14-12**  demonstrates how the class works.


## Program 14-12

```
1 // This program demonstrates an overloaded []
operator.
2 #include <iostream>
3 #include "IntArray.h"
4 using namespace std;
5
6 int main()
7 {
8     const int SIZE = 10; // Array size
9
10    // Define an IntArray with 10 elements.
11    IntArray table(SIZE);
12
13    // Store values in the array.
14    for (int x = 0; x < SIZE; x++)
15        table[x] = (x * 2);
16
17    // Display the values in the array.
18    for (int x = 0; x < SIZE; x++)
19        cout << table[x] << " ";
20    cout << endl;
21
22    // Use the standard + operator on array
```

```
elements.  
23     for (int x = 0; x < SIZE; x++)  
24         table[x] = table[x] + 5;  
25  
26     // Display the values in the array.  
27     for (int x = 0; x < SIZE; x++)  
28         cout << table[x] << " ";  
29     cout << endl;  
30  
31     // Use the standard ++ operator on array  
elements.  
32     for (int x = 0; x < SIZE; x++)  
33         table[x]++;  
34  
35     // Display the values in the array.  
36     for (int x = 0; x < SIZE; x++)  
37         cout << table[x] << " ";  
38     cout << endl;  
39  
40     return 0;  
41 }
```

## Program Output

```
0 2 4 6 8 10 12 14 16 18
5 7 9 11 13 15 17 19 21 23
6 8 10 12 14 16 18 20 22 24
```

**Program 14-13**  demonstrates the `IntArray` class's bounds-checking capability.

## Program 14-13

```
1 // This program demonstrates the IntArray
class's bounds-checking ability.
2 #include <iostream>
3 #include "IntArray.h"
4 using namespace std;
5
6 int main()
7 {
8     const int SIZE = 10; // Array size
9
10    // Define an IntArray with 10 elements.
11    IntArray table(SIZE);
12
13    // Store values in the array.
14    for (int x = 0; x < SIZE; x++)
15        table[x] = x;
16
17    // Display the values in the array.
18    for (int x = 0; x < SIZE; x++)
19        cout << table[x] << " ";
20    cout << endl;
21
22    // Attempt to use an invalid subscript.
```



```
23     cout << "Now attempting to use an invalid
subscript.\n";
24     table[SIZE + 1] = 0;
25     return 0;
26 }
```

## Program Output

```
0 1 2 3 4 5 6 7 8 9
Now attempting to use an invalid subscript.
ERROR: Subscript out of range.
```

## 14.6 Object Conversion

### Concept:

Special operator functions may be written to convert a class object to any other type.

As you've already seen, operator functions allow classes to work more like built-in data types. Another capability that operator functions can give classes is automatic type conversion.

Data type conversion happens “behind the scenes” with the built-in data types. For instance, suppose a program uses the following variables:

```
int i;  
double d;
```

The statement below automatically converts the value in `i` to a floating-point number and stores it in `d`:

```
d = i;
```

Likewise, the following statement converts the value in `d` to an integer (truncating the fractional part) and stores it in `i`:

```
i = d;
```

The same functionality can also be given to class objects. For example, assuming `distance` is a `FeetInches` object and `d` is a `double`, the following statement would conveniently convert `distance`'s value into a floating-point number and store it in `d`, if `FeetInches` is properly written:

```
d = distance;
```

To be able to use a statement such as this, an operator function must be written to perform the conversion. The Student Source Code Folder [Chapter 14](#) \FeetInches Version 5 contains a version of the `FeetInches` class with such an operator function. Here is the code for the operator function that converts a `FeetInches` object to a `double`:

```
FeetInches::operator double()
{
    double temp = feet;
    temp += (inches / 12.0);
    return temp;
}
```

This function contains an algorithm that will calculate the decimal equivalent of a feet and inches measurement. For example, the value 4 feet 6 inches will be converted to 4.5. This value is stored in the local variable `temp`. The `temp` variable is then returned.



### Note:

No return type is specified in the function header. Because the function is a `FeetInches-to-double` conversion function, it will always return a `double`. Also, because the function takes no arguments, there are no parameters.

The revised `FeetInches` class also has an operator function that converts a `FeetInches` object to an `int`. The function, shown here, simply returns the `feet` member, thus truncating the `inches` value:

```
FeetInches:: operator int()
{
    return feet;
}
```

**Program 14-14** [□](#) demonstrates both of these conversion functions. (This file can also be found in the Student Source Code Folder **Chapter 14** [□](#) FeetInches Version 5.)

## Program 14-14

```
1 // This program demonstrates the FeetInches
class's
2 // conversion functions.
3 #include <iostream>
4 #include "FeetInches.h"
5 using namespace std;
6
7 int main()
8 {
9     double d; // To hold double input
10    int i;     // To hold int input
11
12    // Define a FeetInches object.
13    FeetInches distance;
14
15    // Get a distance from the user.
16    cout << "Enter a distance in feet and
inches:\n";
17    cin >> distance;
18
19    // Convert the distance object to a
double.
20    d = distance;
```

```
21
22     // Convert the distance object to an int.
23     i = distance;
24
25     // Display the values.
26     cout << "The value " << distance;
27     cout << " is equivalent to " << d << "
feet\n";
28     cout << "or " << i << " feet, rounded
down.\n";
29     return 0;
30 }
```

### Program Output with Example Input Shown in Bold

```
Enter a distance in feet and inches:
Feet: 8 Enter
Inches: 6 Enter
The value 8 feet, 6 inches is equivalent to
8.5 feet
or 8 feet, rounded down.
```

See the Case Study on Creating a String Class for another example. You can download the case study from the Computer Science Portal


at [www.pearsonhighered.com/gaddis](http://www.pearsonhighered.com/gaddis).

## Checkpoint

14.27 When overloading a binary operator such as + or −, what object is passed into the operator function's parameter?

14.28 Explain why overloaded prefix and postfix ++ and — operator functions should return a value.

14.29 How does C++ tell the difference between an overloaded prefix and postfix ++ or — operator function?

14.30 Write member functions of the `FeetInches` class that overload the prefix and postfix — operators. Demonstrate the functions in a simple program similar to [Program 14-14](#) .



## 14.7 Aggregation

### Concept:

Aggregation occurs when a class contains an instance of another class.



### Class Aggregation

In real life, objects are frequently made of other objects. A house, for example, is made of door objects, window objects, wall objects, and much more. It is the combination of all these objects that makes a house object.

When designing software, it sometimes makes sense to create an object from other objects. For example, suppose you need an object to represent a course that you are taking in college. You decide to create a `Course` class, which will hold the following information:

- The course name
- The instructor's last name, first name, and office number
- The textbook's title, author, and publisher

In addition to the course name, the class will hold items related to the instructor and the textbook. You could put attributes for each of these items in the `Course` class. However, a good design principle is to separate related items into their own classes. In this example, an `Instructor` class could be created to hold the instructor-related data, and a `TextBook` class could be created to hold the textbook-related data. Instances of these classes could then be used as attributes in the `Course` class.

Let's take a closer look at how this might be done. To keep things simple, the `Instructor` class will have only the following functions:

- A default constructor that assigns empty strings to the instructor's last name, first name, and office number.
- A constructor that accepts arguments for the instructor's last name, first name, and office number
- `set`—a function that can be used to set all of the class's attributes
- `print`—a function that displays the object's attribute values

The code for the `Instructor` class is shown here:

## Contents of `Instructor.h`

```
1 #ifndef INSTRUCTOR
2 #define INSTRUCTOR
3 #include <iostream>
4 #include <string>
5 using namespace std;
6
7 // Instructor class
8 class Instructor
9 {
10 private:
11     string lastName; // Last name
12     string firstName; // First name
13     string officeNumber; // Office number
14 public:
15     // The default constructor stores empty strings
16     // in the string objects.
17     Instructor()
18     { set("", "", ""); }
19
20     // Constructor
21     Instructor(string lname, string fname, string office)
22     { set(lname, fname, office); }
23
24     // set function
25     void set(string lname, string fname, string office)
26     { lastName = lname;
27       firstName = fname;
28       officeNumber = office; }
29
30     // print function
31     void print() const
32     { cout << "Last name: " << lastName << endl;
33       cout << "First name: " << firstName << endl;
34       cout << "Office number: " << officeNumber << endl; }
```

```
35 };  
36 #endif
```

The code for the `TextBook` class is shown next. As before, we want to keep the class simple. The only functions it has are a default constructor, a constructor that accepts arguments, a `set` function, and a `print` function.

## Contents of `TextBook.h`

```
1 #ifndef TEXTBOOK
2 #define TEXTBOOK
3 #include <iostream>
4 #include <string>
5 using namespace std;
6
7 // TextBook class
8 class TextBook
9 {
10 private:
11     string title; // Book title
12     string author; // Author name
13     string publisher; // Publisher name
14 public:
15     // The default constructor stores empty strings
16     // in the string objects.
17     TextBook()
18     { set("", "", ""); }
19
20     // Constructor
21     TextBook(string textTitle, string auth, string pub)
22     { set(textTitle, auth, pub); }
23
24     // set function
25     void set(string textTitle, string auth, string pub)
26     { title = textTitle;
27       author = auth;
28       publisher = pub; }
29
30     // print function
31     void print() const
32     { cout << "Title: " << title << endl;
33       cout << "Author: " << author << endl;
34       cout << "Publisher: " << publisher << endl; }
```

```
35 };  
36 #endif
```

The `Course` class is shown next. Notice the `Course` class has an `Instructor` object and a `TextBook` object as member variables. Those objects are used as attributes of the `Course` object. Making an instance of one class an attribute of another class is called *object aggregation*. The word *aggregate* means “a whole that is made of constituent parts.” In this example, the `Course` class is an aggregate class because an instance of it is made of constituent objects.

When an instance of one class is a member of another class, it is said that there is a “has a” relationship between the classes. For example, the relationships that exist among the `Course`, `Instructor`, and `TextBook` classes can be described as follows:


- The course *has an* instructor.
- The course *has a* textbook.

The “has a” relationship is sometimes called a *whole–part relationship* because one object is part of a greater whole.

## Contents of `Course.h`

```
1 #ifndef COURSE
2 #define COURSE
3 #include <iostream>
4 #include <string>
5 #include "Instructor.h"
6 #include "TextBook.h"
7 using namespace std;
8
9 class Course
10 {
11 private:
12     string courseName;    // Course name
13     Instructor instructor; // Instructor
14     TextBook textbook;    // Textbook
15 public:
16     // Constructor
17     Course(string course, string instrLastName,
18            string instrFirstName, string instrOffice,
19            string textTitle, string author,
20            string publisher)
21     { // Assign the course name.
22         courseName = course;
23
24         // Assign the instructor.
25         instructor.set(instrLastName, instrFirstName, instrOffice);
26
27         // Assign the textbook.
28         textbook.set(textTitle, author, publisher); }
29
30     // print function
31     void print() const
32     { cout << "Course name: " << courseName << endl << endl;
33       cout << "Instructor Information:\n";
34       instructor.print();
35       cout << "\nTextbook Information:\n";
36       textbook.print();
37       cout << endl;}
```

```
38 };  
39 #endif
```

**Program 14-15**  demonstrates the `Course` class.



## Program 14-15

```
1 // This program demonstrates the Course class.
2 #include "Course.h"
3
4 int main()
5 {
6     // Create a Course object.
7     Course myCourse("Intro to Computer Science", // Course name
8                     "Kramer", "Shawn", "RH3010", // Instructor info
9                     "Starting Out with C++", "Gaddis", // Textbook title and author
10                    "Pearson"); // Textbook publisher
11
12     // Display the course info.
13     myCourse.print();
14     return 0;
15 }
```

## Program Output

```
Course name: Intro to Computer Science
```

```
Instructor Information:
```

```
Last name: Kramer
```

```
First name: Shawn
```

```
Office number: RH3010
```

```
Textbook Information:
```

```
Title: Starting Out with C++
```

```
Author: Gaddis
```

```
Publisher: Pearson
```

# Using Member Initialization Lists with Aggregate Classes

Recall from [Chapter 13](#) that in a constructor, you can use a member initialization list as an alternative way to initialize the class's member variables. An aggregate class's constructor can also use a member initialization list to call the constructors for each of its member objects. The following shows how we could rewrite the constructor for the `Course` class, using a member initialization list:

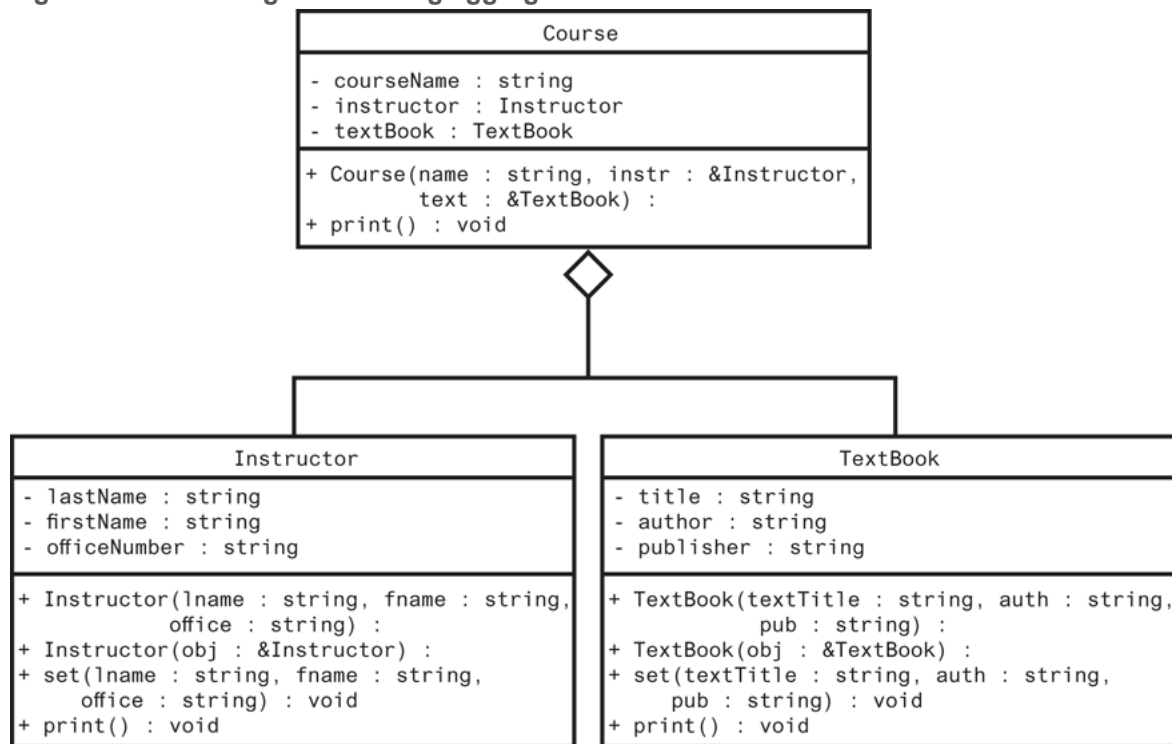
```
1 Course(string course, string instrLastName, string instrFirstName,  
2         string instrOffice, string textTitle, string author,  
3         string publisher) :  
4   instructor(instrLastName, instrFirstName, instrOffice),  
5   textbook(textTitle, author, publisher)  
6 {  
7     // Assign the course name.  
8     courseName = course;  
9 }
```

In this version of the constructor, a colon appears at the end of the function header (line 3), followed by the member initialization list (lines 4 and 5). Line 4 calls the `instructor` member's constructor, passing the necessary arguments, and line 5 calls the `textbook` member's constructor, passing the necessary arguments. Notice in the initialization list we are using the names of the member objects, rather than their classes. This allows constructors of different objects of the same class to be invoked in the same initialization list.

# Aggregation in UML Diagrams

In [Chapter 13](#), you were introduced to the Unified Modeling Language (UML) as a tool for designing classes. You show aggregation in a UML diagram by connecting two classes with a line that has an open diamond at one end. The diamond is closest to the class that is the aggregate. [Figure 14-7](#) shows a UML diagram depicting the relationship between the `Course`, `Instructor`, and `TextBook` classes. The open diamond is closest to the `Course` class because it is the aggregate (the whole).

Figure 14-7 UML diagram showing aggregation



## 14.8 Focus on Object-Oriented Design: Class Collaborations

### Concept:

It is common for classes to interact, or collaborate, with one another to perform their operations. Part of the object-oriented design process is identifying the collaborations between classes.

In an object-oriented application, it is common for objects of different classes to collaborate. This simply means objects interact with each other. Sometimes one object will need the services of another object in order to fulfill its responsibilities. For example, let's say an object needs to read a number from the keyboard then format the number to appear as a dollar amount. The object might use the services of the `cin` object to read the number from the keyboard then use the services of another object that is designed to format the number.

If one object is to collaborate with another object, then it must know something about the other object's member functions and how to call them. Let's look at an example.

The following code shows a class named `Stock`. An object of this class holds data about a company's stock. This class has two attributes: `symbol` and `sharePrice`. The `symbol` attribute holds the trading symbol for the company's stock. This is a short series of characters that are used to identify the stock on the stock exchange. For example, the XYZ Company's stock might have the trading symbol XYZ. The `sharePrice` attribute holds the current price per share of the stock. The class also has the following member functions:

- A default constructor that initializes `symbol` to an empty string and `sharePrice` to 0.0.
- A constructor that accepts arguments for the symbol and share price.
- A copy constructor.
- `set`—a function that accepts arguments for the symbol and share price
- `getSymbol`—a function that returns the stock's trading symbol
- `getSharePrice`—a function that returns the current price of the stock

## Contents of `Stock.h`


```
1 #ifndef STOCK
2 #define STOCK
3 #include <string>
4 using namespace std;
5
6 class Stock
7 {
8 private:
9     string symbol;    // Trading symbol of the stock
10    double sharePrice; // Current price per share
11 public:
12     // Default constructor
13     Stock()
14     { set("", 0.0); }
15
16     // Constructor
17     Stock(const string sym, double price)
18     { set(sym, price); }
19
20     // Copy constructor
21     Stock(const Stock &obj)
22     { set(obj.symbol, obj.sharePrice); }
23
24     // Mutator function
25     void set(string sym, double price)
26     { symbol = sym;
27       sharePrice = price; }
28
29     // Accessor functions
30     string getSymbol() const
31     { return symbol; }
32
33     double getSharePrice() const
34     { return sharePrice; }
```

```
35 };  
36 #endif
```

The following code shows another class named `StockPurchase` that uses an object of the `Stock` class to simulate the purchase of a stock. The `StockPurchase` class is responsible for calculating the cost of the stock purchase. To do that, the `StockPurchase` class must know how to call the `Stock` class's `getSharePrice` function to get the price per share of the stock.

## Contents of `StockPurchase.h`

```
1 #ifndef STOCK_PURCHASE
2 #define STOCK_PURCHASE
3 #include "Stock.h"
4
5 class StockPurchase
6 {
7 private:
8     Stock stock; // The stock that was purchased
9     int shares; // The number of shares
10 public:
11     // The default constructor sets shares to 0. The stock
12     // object is initialized by its default constructor.
13     StockPurchase()
14         { shares = 0;}
15
16     // Constructor
17     StockPurchase(const Stock &stockObject, int numShares)
18         { stock = stockObject;
19         shares = numShares; }
20
21     // Accessor function
22     double getCost() const
23         { return shares * stock.getSharePrice(); }
24 };
25 #endif
```

The second constructor for the `StockPurchase` class accepts a `Stock` object representing the stock that is being purchased, and an `int` representing the number of shares to purchase. In line 18, we see the first collaboration: the `StockPurchase` constructor makes a copy of the `Stock` object by using the `Stock` class's copy constructor. The next collaboration takes place in the `getCost` function. This function calculates and returns the cost of the stock purchase. In line 23, it calls the `Stock` class's `getSharePrice` function to determine the stock's price per share. [Program 14-16](#)  demonstrates this class.

## Program 14-16

```
1 // Stock trader program
2 #include <iostream>
3 #include <iomanip>
4 #include "Stock.h"
5 #include "StockPurchase.h"
6 using namespace std;
7
8 int main()
9 {
10     int sharesToBuy; // Number of shares to buy
11
12     // Create a Stock object for the company stock. The
13     // trading symbol is XYZ and the stock is currently
14     // priced at $9.62 per share.
15     Stock xyzCompany("XYZ", 9.62);
16
17     // Display the symbol and current share price.
18     cout << setprecision(2) << fixed << showpoint;
19     cout << "XYZ Company's trading symbol is "
20         << xyzCompany.getSymbol() << endl;
21     cout << "The stock is currently $"
22         << xyzCompany.getSharePrice()
23         << " per share.\n";
24
25     // Get the number of shares to purchase.
26     cout << "How many shares do you want to buy? ";
27     cin >> sharesToBuy;
28
29     // Create a StockPurchase object for the transaction.
30     StockPurchase buy(xyzCompany, sharesToBuy);
31
32     // Display the cost of the transaction.
33     cout << "The cost of the transaction is $"
34         << buy.getCost() << endl;
35     return 0;
36 }
```



### Program Output with Example Input Shown in Bold

```
XYZ Company's trading symbol is XYZ  
The stock is currently $9.62 per share.  
How many shares do you want to buy? 100 Enter  
The cost of the transaction is $962.00
```

# Determining Class Collaborations with CRC Cards

During the object-oriented design process, you can determine many of the collaborations that will be necessary between classes by examining the responsibilities of the classes. In [Chapter 13](#), we discussed the process of finding the classes and their responsibilities. Recall from that section that a class's responsibilities are:

- the things that the class is responsible for knowing.
- the actions that the class is responsible for doing.

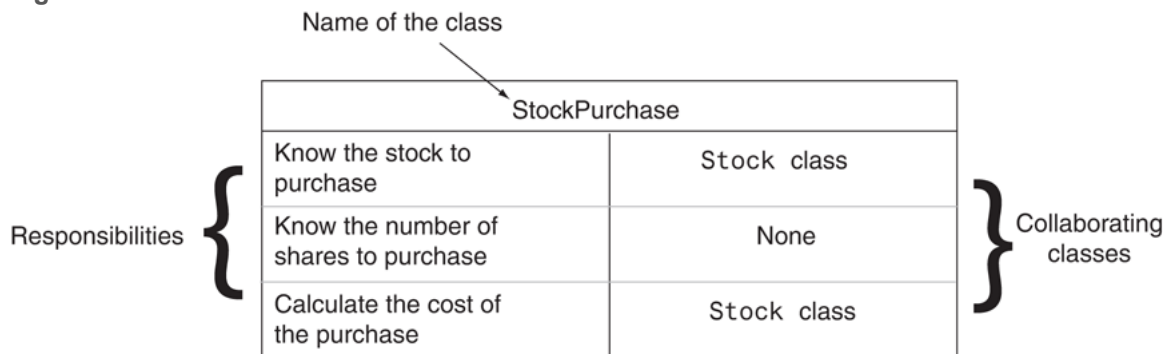
Often you will determine that the class must collaborate with another class in order to fulfill one or more of its responsibilities. One popular method of discovering a class's responsibilities and collaborations is by creating CRC cards. CRC stands for class, responsibilities, and collaborations.

You can use simple index cards for this procedure. Once you have gone through the process of finding the classes (which was discussed in [Chapter 13](#)), set aside one index card for each class. At the top of the index card, write the name of the class. Divide the rest of the card into two columns. In the left column, write each of the class's responsibilities. As you write each responsibility, think about whether the class needs to collaborate with another class to fulfill that responsibility. Ask yourself questions such as:

- Will an object of this class need to get data from another object in order to fulfill this responsibility?
- Will an object of this class need to request another object to perform an operation in order to fulfill this responsibility?

If collaboration is required, write the name of the collaborating class in the right column, next to the responsibility that requires it. If no collaboration is required for a responsibility, simply write "None" in the right column, or leave it blank. [Figure 14-8](#) shows an example CRC card for the `StockPurchase` class.

**Figure 14-8** CRC card



From the CRC card shown in the figure, we can see that the `StockPurchase` class has the following responsibilities and collaborations:

- Responsibility: To know the stock to purchase  
Collaboration: The `Stock` class
- Responsibility: To know the number of shares to purchase  
Collaboration: None
- Responsibility: To calculate the cost of the purchase  
Collaboration: The `Stock` class

When you have completed a CRC card for each class in the application, you will have a good idea of each class's responsibilities and how the classes must interact.

## *Checkpoint*

14.31 What are the benefits of having operator functions that perform object conversion?

14.32 Why are no return types listed in the prototypes or headers of operator functions that perform data type conversion?


14.33 Assume there is a class named `BlackBox`. Write the header for a member function that converts a `BlackBox` object to an `int`.

14.34 Assume there are two classes, `Big` and `Small`. The `Big` class has, as a member, an instance of the `Small` class. Write a sentence that describes the relationship between the two classes.

# 14.9 Focus on Object-Oriented Programming: Simulating the Game of Cho-Han

Cho-Han is a traditional Japanese gambling game in which a dealer uses a cup to roll two six-sided dice. The cup is placed upside down on a table so the value of the dice is concealed. Players then wager on whether the sum of the dice values is even (Cho) or odd (Han). The winner, or winners, take all of the wagers, or the house takes them if there are no winners.

We will develop a program that simulates a simplified variation of the game. The simulated game will have a dealer and two players. The players will not wager money, but will simply guess whether the sum of the dice values is even (Cho) or odd (Han). One point will be awarded to the player, or players, for correctly guessing the outcome. The game is played for five rounds, and the player with the most points is the grand winner.

In the program, we will use the `Die` class introduced in [Chapter 13](#)  to simulate the dice. We will create two instances of the `Die` class to represent two six-sided dice. In addition to the `Die` class, we will write the following classes:

- `Dealer` class: We will create an instance of this class to represent the dealer. It will have the ability to roll the dice, report the value of the dice, and report whether the total dice value is Cho or Han.
- `Player` class: We will create two instances of this class to represent the players. Instances of the `Player` class can store the player's name, make a guess between Cho or Han, and be awarded points.

First, let's look at the `Dealer` class.

## Contents of Dealer.h

```
1 // Specification file for the Dealer class
2 #ifndef DEALER_H
3 #define DEALER_H
4 #include <string>
5 #include "Die.h"
6 using namespace std;
7
8 class Dealer
9 {
10 private:
11     Die die1; // Object
12     for die #1
13     Die die2; // Object
14     for die #2
15     int die1Value; // Value of
16     die #1
17     int die2Value; // Value of
18     die #2
19
20 public:
21     Dealer(); //
22     Constructor
23     void rollDice(); // To roll
```

the dice

```
19     string getChoOrHan();           // To get the
```

```
result (Cho or Han)
```

```
20     int getDie1Value();           // To get the
```

```
value of die #1
```

```
21     int getDie2Value();           // To get the
```

```
value of die #2
```

```
22 };
```

```
23 #endif
```

## Contents of Dealer.cpp

```
1 // Implementation file for the Dealer class
2 #include "Dealer.h"
3 #include "Die.h"
4 #include <string>
5 using namespace std;
6
7 //*****
8 // Constructor *
9 //*****
10 Dealer::Dealer()
11 {
12     // Set the initial dice values to 0.
13     // (We will not use these values.)
14     die1Value = 0;
15     die2Value = 0;
16 }
17
18 //*****
19 // The rollDice member function rolls the *
20 // dice and saves their values. *
21 //*****
22 void Dealer::rollDice()
23 {
```



```
24     // Roll the dice.
25     die1.roll();
26     die2.roll();
27
28     // Save the dice values.
29     die1Value = die1.getValue();
30     die2Value = die2.getValue();
31 }
32
33 //*****
34 // The getChoOrHan member function returns *
35 // the result of the dice roll, Cho (even) *
36 // or Han (odd). *
37 //*****
38 string Dealer::getChoOrHan()
39 {
40     string result; // To hold the result
41
42     // Get the sum of the dice.
43     int sum = die1Value + die2Value;
44
45     // Determine even or odd.
46     if (sum % 2 == 0)
47         result = "Cho (even)";
48     else
49         result = "Han (odd)";
50
```

```

51     // Return the result.
52     return result;
53 }
54
55 //*****
56 // The getDie1Value member function returns *
57 // the value of die #1. *
58 //*****
59 int Dealer::getDie1Value()
60 {
61     return die1Value;
62 }
63
64 //*****
65 // The getDie2Value member function returns *
66 // the value of die #2. *
67 //*****
68 int Dealer::getDie2Value()
69 {
70     return die2Value;
71 }

```

Here is a synopsis of the class members:

Now, let's look at the `Player` class.

## Contents of `Player.h`

```
1 // Specification file for the Player class
2 #ifndef PLAYER_H
3 #define PLAYER_H
4 #include <string>
5 using namespace std;
6
7 class Player
8 {
9     private:
10         string name;           // The player's
name
11         string guess;         // The player's
guess
12         int points;          // The player's
points
13
14     public:
15         Player(string);       // Constructor
16         void makeGuess();     // Causes player to
make a guess
17         void addPoints(int);  // Adds points to
the player
18         string getName();     // Returns the
```

```
player's name
19     string getGuess();    // Returns the
player's guess
20     int getPoints();     // Returns the
player's points
21 };
22 #endif
```

## Contents of `Player.cpp`

```
1 // Implementation file for the Player class
2 #include "Player.h"
3 #include <cstdlib>
4 #include <ctime>
5 #include <string>
6 using namespace std;
7
8
9 //*****
9 // Constructor
*
10
11 //*****
11 Player::Player(string playerName)
12 {
13     // Seed the random number generator.
14     srand(time(0));
15
16     name = playerName;
17     guess = "";
18     points = 0;
19 }
20
```

```

21
//*****
22 // The makeGuess member function causes the
*
23 // player to make a guess, either "Cho (even)"
*
24 // or "Han (odd)".
*
25
//*****
26 void Player::makeGuess()
27 {
28     const int MIN_VALUE = 0;
29     const int MAX_VALUE = 1;
30
31     int guessNumber; // For the user's guess
32
33     // Get a random number, either 0 or 1.
34     guessNumber = (rand() % (MAX_VALUE -
MIN_VALUE + 1)) + MIN_VALUE;
35
36     // Convert the random number to Cho or
Han.
37     if (guessNumber == 0)
38         guess = "Cho (even)";
39     else
40         guess = "Han (odd)";

```


```
41 }
42
43
//*****
44 // The addPoints member function adds a
*
45 // specified number of points to the player's
*
46 // current balance.
*
47
//*****
48 void Player::addPoints(int newPoints)
49 {
50     points += newPoints;
51 }
52
53
//*****
54 // The getName member function returns a
*
55 // player's name.
*
56
//*****
57 string Player::getName()
58 {
```

```
59     return name;
60 }
61
62
63 //*****
64 // The getGuess member function returns a
65 *
66 // player's guess.
67 *
68
69 //*****
70 string Player::getGuess()
71 {
72     return guess;
73 }
74
75 //*****
76 // The getPoints member function returns a
77 *
78 // player's points.
79 *
80
81 //*****
82 int Player::getPoints()
83 {
```



```
77     return points;
78 }
```

Here is a synopsis of the class members:

**Program 14-17**  uses these classes to simulate the game. The `main` function simulates five rounds of the game, displaying the results of each round, then displays the overall game results.

## Program 14-17

```
1 // This program simulates the game of Cho-
Han.
2 #include <iostream>
3 #include <string>
4 #include "Dealer.h"
5 #include "Player.h"
6 using namespace std;
7
8 // Function prototypes
9 void roundResults(Dealer &, Player &, Player
&);
10 void checkGuess(Player &, Dealer &);
11 void displayGrandWinner(Player, Player);
12
13 int main()
14 {
15     const int MAX_ROUNDS = 5; // Number of
rounds
16     string player1Name; // First
player's name
17     string player2Name; // Second
player's name
18
```

```
19 // Get the player's names.
20 cout << "Enter the first player's name:
";
21 cin >> player1Name;
22 cout << "Enter the second player's name:
";
23
24
25 // Create the dealer.
26 Dealer dealer;
27
28 // Create the two players.
29 Player player1(player1Name);
30 Player player2(player2Name);
31
32 // Play the rounds.
33 for (int round = 0; round < MAX_ROUNDS;
round++)
34 {
35     cout << "-----
\n";
36     cout << "Now playing round " <<
(round + 1)
37         << endl;
38
39     // Roll the dice.
40     dealer.rollDice();
```

```

41
42     // The players make their guesses.
43     player1.makeGuess();
44     player2.makeGuess();
45
46     // Determine the winner of this
round.
47     roundResults(dealer, player1,
player2);
48 }
49
50 // Display the grand winner.
51 displayGrandWinner(player1, player2);
52 return 0;
53 }
54
55
//*****
****
56 // The roundResults function determines the
results *
57 // of the current round.
*
58
//*****
****
59 void roundResults(Dealer &dealer, Player

```

```
&player1, Player &player2)
60 {
61     // Show the dice values.
62     cout << "The dealer rolled " <<
dealer.getDie1Value()
63         << " and " << dealer.getDie2Value()
<< endl;
64
65     // Show the result (Cho or Han).
66     cout << "Result: " <<
dealer.getChoOrHan() << endl;
67
68     // Check each player's guess and award
points.
69     checkGuess(player1, dealer);
70     checkGuess(player2, dealer);
71 }
72
73
//*****
***
74 // The checkGuess function checks a player's
guess *
75 // against the dealer's result.
*
76
//*****
```

```

***
77 void checkGuess(Player &player, Dealer
&dealer)
78 {
79     const int POINTS_TO_ADD = 1; // Points to
award winner
80
81     // Get the player's guess
82     string guess = player.getGuess();
83
84     // Get the result (Cho or Han).
85     string choHanResult =
dealer.getChoOrHan();
86
87     // Display the player's guess.
88     cout << "The player " << player.getName()
89         << " guessed " << player.getGuess()
<< endl;
90
91     // Award points if the player guessed
correctly.
92     if (guess == choHanResult)
93     {
94         player.addPoints(POINTS_TO_ADD);
95         cout << "Awarding " << POINTS_TO_ADD
96             << " point(s) to " <<
player.getName()

```

```

97         << endl;
98     }
99 }
100
101
102 //*****
103 // The displayGrandWinner function displays
104 // the *
105 // game's grand winner.
106 // *
107 //*****
108 void displayGrandWinner(Player player1,
109 Player player2)
110 {
111     cout << "-----\n";
112     cout << "Game over. Here are the
113 results:\n";
114     // Display player #1's results.
115     cout << player1.getName() << ": "
116         << player1.getPoints() << "
117 points\n";
118     // Display player #2's results.

```

```
115     cout << player2.getName() << ": "
116         << player2.getPoints() << "
points\n";
117
118     // Determine the grand winner.
119     if (player1.getPoints() >
player2.getPoints())
120     {
121         cout << player1.getName()
122             << " is the grand winner!\n";
123     }
124     else if (player2.getPoints() >
player1.getPoints())
125     {
126         cout << player2.getName()
127             << " is the grand winner!\n";
128     }
129     else
130     {
131         cout << "Both players are tied!\n";
132     }
133 }
```

**Program Output with Example Input Shown in Bold**



Enter the first player's name: **Bill** Enter  
Enter the second player's name: **Jill** Enter

-----

Now playing round 1  
The dealer rolled 4 and 6  
Result: Cho (even)  
The player Bill guessed Cho (even)  
Awarding 1 point(s) to Bill  
The player Jill guessed Cho (even)  
Awarding 1 point(s) to Jill

-----

Now playing round 2  
The dealer rolled 5 and 2  
Result: Han (odd)  
The player Bill guessed Han (odd)  
Awarding 1 point(s) to Bill  
The player Jill guessed Han (odd)  
Awarding 1 point(s) to Jill

-----

Now playing round 3  
The dealer rolled 4 and 2  
Result: Cho (even)  
The player Bill guessed Cho (even)  
Awarding 1 point(s) to Bill  
The player Jill guessed Cho (even)  
Awarding 1 point(s) to Jill

-----

Now playing round 4

```
The dealer rolled 3 and 2
Result: Han (odd)
The player Bill guessed Han (odd)
Awarding 1 point(s) to Bill
The player Jill guessed Cho (even)
-----

Now playing round 5
The dealer rolled 4 and 6
Result: Cho (even)
The player Bill guessed Han (odd)
The player Jill guessed Han (odd)
-----

Game over. Here are the results:
Bill: 4 points
Jill: 3 points
Bill is the grand winner!
```

Let's look at the code. Here is a summary of the `main` function:

- Lines 15 through 17 make the following declarations: `MAX_ROUNDS`—the number of rounds to play, `player1Name`—to hold the name of player #1, and `player2Name`—to hold the name of player #2.
- Lines 20 through 23 prompt the user to enter the player's names.
- Line 26 creates an instance of the `Dealer` class to represent the dealer.

- Line 29 creates an instance of the `Player` class to represent player #1. Notice `player1Name` is passed as an argument to the constructor.
- Line 30 creates another instance of the `Player` class to represent player #2. Notice `player2Name` is passed as an argument to the constructor.
- The `for` loop that begins in line 33 iterates five times, causing the simulation of five rounds of the game. The loop performs the following actions:
  - Line 40 causes the dealer to roll the dice.
  - Line 43 causes player #1 to make a guess (Cho or Han).
  - Line 44 causes player #2 to make a guess (Cho or Han).
  - Line 47 passes the `dealer`, `player1`, and `player2` objects to the `roundResults` function. The function displays the results of this round.
- Line 51 passes the `player1` and `player2` objects to the `displayGrandWinner` function, which displays the grand winner of the game.

The `roundResults` function, which displays the results of a round, appears in lines 59 through 71. Here is a summary of the function:

- The function accepts references to the `dealer`, `player1`, and `player2` objects as arguments.
- The statement in lines 62 and 63 displays the value of the two dice.

- Line 66 calls the `dealer` object's `getChoOrHan` function to display the results, Cho or Han.
- Line 69 calls the `checkGuess` function, passing the `player1` and `dealer` objects as arguments. The `checkGuess` function compares a player's guess to the dealer's result (Cho or Han), and awards points to the player if the guess is correct.
- Line 70 calls the `checkGuess` function, passing the `player2` and `dealer` objects as arguments.

The `checkGuess` function, which compares a player's guess to the dealer's result, awarding points to the player for a correct guess, appears in lines 77 through 99. Here is a summary of the function:

- The function accepts references to a `Player` object and the `Dealer` object as arguments.
- Line 79 declares the constant `POINTS_TO_ADD`, set to the value 1, which is the number of points to add to the player's balance if the player's guess is correct.
- Line 82 assigns the player's guess to the `string` object `guess`.
- Line 85 assigns the dealer's results (Cho or Han) to the `string` object `choHanResult`.
- The statement in lines 88 and 89 displays the player's name and guess.
- The `if` statement in line 92 compares the player's guess to the dealer's result. If they match, then the player guessed correctly, and line 94 awards points to the player.

The `displayGrandWinner` function, which displays the grand winner of the game, appears in lines 105 through 133. Here is a summary of the function:

- The function accepts the `player1` and `player2` objects as arguments.
- The statements in lines 111 through 116 display both players' names and points.
- The `if-else-if` statement that begins in line 119 determines which of the two players has the highest score and displays that player's name as the grand winner. If both players have the same score, a tie is declared.

# 14.10 Rvalue References and Move Semantics

## **Concept:**

A move operation transfers resources from a source object to a target object. A move operation is appropriate when the source object is temporary and is about to be destroyed.

C++ has always been regarded as a high-performance language. Typically, it is the language of choice for developers who need to write fast, efficient code. The C++ 11 standard introduced new features that make C++ even faster and more efficient. One of these new features is the ability to use *move semantics* in your classes. In certain situations, you can use move semantics to greatly improve the performance of assignment operations. You can also use move semantics to write a new type of constructor known as a move constructor. Before we can discuss move semantics, however, we must introduce another new topic: rvalue references.

# Lvalues and Rvalues

During the execution of a program, numerous entities, such as variables, class objects, and so on, are created in memory. For example, look at the following `main` function:

```
1 int main()
2 {
3     int x = 0;
4
5     x = 12;
6     cout << x << endl;
7     return 0;
8 }
```

In this code, an `int` variable named `x` is created in line 3. Although the variable is created by the statement in line 3, it is meant to be accessible to other statements. In fact, any statement in the variable's scope can use the name `x` to access the variable. For example, line 5 assigns the value 12 to the `x` variable, and line 6 displays the contents of the `x` variable.

Some entities, such as the variable `x` in the previous example, are created by definition statements and meant to exist in memory long enough for other statements to access them. Other entities,

however, are meant to exist only temporarily. For example, look at the following code fragment:

```
int x;  
x = 2 * 6;
```

When the second statement executes, the system evaluates the expression on the right side of the `=` operator. In this case, it gets the value of `2 * 6` and stores the result, 12, as a temporary value. Then, it copies the temporary value to the `x` variable. After the statement executes, the temporary value is no longer needed, so the system discards it.

Values that are returned from functions are also stored as temporary values. When a function returns a value, you have to immediately do something with the value, or you will lose it. For example, look at the following code fragment:



```
1  int square(int a)
2  {
3      return a * a;
4  }
5
6  int main()
7  {
8      int x = 0;
9
10     x = square(5);
11     cout << x << endl;
12     return 0;
13 }
```

Consider the statement in line 10. We can summarize the statement by saying it calls the `square` function, and assigns the value that is returned from the `square` function to the variable `x`. But more specifically, all of the following things happen when this statement executes:

- The `square` function is called, and the value 5 is passed as an argument.
- The `square` function calculates `5 * 5` and stores the result, 25, as a temporary value.
- The temporary value is copied (assigned) to the variable `x`.

- The temporary value is no longer needed, so the system discards it.

To further illustrate this, look at the following code fragment:

```
1  int square(int a)
2  {
3      return a * a;
4  }
5
6  int main()
7  {
8      int x = 0;
9
10     square(5);
11     cout << x << endl;
12     return 0;
13 }
```

In this code, the statement in line 10 calls the `square` function, but it doesn't do anything with the value that is returned. As in the previous example, the value 25 is stored as a temporary value. But, in this example, the value is lost forever after the statement has finished executing.

So, we have two types of values stored in memory during the execution of a program:

- Values that persist beyond the statement that created them, and have names that make them accessible to other statements in the program. In C++, these values are called *lvalues*.
- Values that are temporary, and cannot be accessed beyond the statement that created them. In C++, these values are called *rvalues*.

 **Tip:**

Perhaps the simplest way to think of an lvalue is this: it is an expression that can be written on the left side of an assignment operator.

# Rvalue References

In [Chapter 6](#), you learned that a reference variable is a variable that refers to the memory location of another variable. For example, look at the following code fragment:

```
int x = 34;  
int &ref = x;
```

**11** In this code, the variable `ref` is a reference variable. In a declaration, a reference is indicated by the presence of an ampersand (`&`) between the type and the variable's identifier. In C++ 11 and later, this type of reference is called an *lvalue reference* because it can refer only to lvalues.

C++ 11 also introduces the concept of an *rvalue reference*, which is a reference variable that can refer only to temporary objects that would otherwise have no name. An rvalue reference is declared similarly to an lvalue reference, except with a double ampersand (`&&`). The code below uses an rvalue reference to print the square of 5:

```
int &&rvalRef = square(5);  
cout << rvalRef << endl;
```

The first statement calls the `square` function, passing 5 as an argument. The function returns the value 25, which is stored as a temporary value. The address of the temporary value is then assigned to `rvalRef`. So, now we have given a name to the temporary value, so it can be accessed by other statements.

When you assign an rvalue reference to a temporary value, you are giving a name to the temporary value and making it possible to access the value from other parts of the program. Therefore, you are transforming a temporary value into an lvalue. Because an rvalue reference cannot refer to an lvalue, the following code will not compile:

```
int x = 0;  
int &&rvalRef = x;    // Error!
```

Look at the following initialization statement:

```
int &&rvalRef1 = square(5);
```

After this statement executes, the memory location containing the value returned by `square(5)` has a name, `rvalRef1`, so `rvalRef1` itself becomes an lvalue. This means that a subsequent initialization statement such as:

```
int &&rvalRef2 = rvalRef1; // Error!
```

will not compile, because `rvalRef1` is no longer an rvalue.

Fortunately, there is a positive consequence of all this: a temporary object can have at most one lvalue reference pointing to it. If a function has an lvalue reference to a temporary object, you can be sure no other part of the program has access to the same object. This fact is important in understanding how move operations, to be discussed next, work.

# Move Semantics

When objects are passed as arguments into functions, and returned from functions, the program does a lot of work behind the scenes, allocating memory and copying values. To illustrate, let's look at the

`Person` class.

```
#ifndef PERSON_H
#define PERSON_H
#include <cstring>
using namespace std;
class Person
{
private:
    char *name = nullptr;
public:
    // Default constructor
    Person()
    { name = new char[1];
      *name = 0; }
    // Constructor with a parameter
    Person(char *n)
    { name = new char[strlen(n) + 1];
      strcpy(name, n); }
    // Copy constructor
    Person(const Person &obj)
    { name = new char[strlen(obj.name) + 1];
      strcpy(name, obj.name); }
    // Destructor
    ~Person()
    { delete name; }
    // Copy assignment operator
    Person & operator=(const Person &right)
    { if (this != &right)
```




```

    {
        name = new char[strlen(right.name) + 1];
        strcpy(name, right.name);
    }
    return *this; }

// getName member function
char *getName() const
{ return name; }
};

#endif

```

The `Person` class has three constructors: a default constructor, a parameterized constructor, and a copy constructor. It also has an overloaded `=` operator, and a member function to get the `name` member variable. We are going to use this class to demonstrate some of the work that happens when an object is passed around in a program. But first, we are going to insert some `cout` statements so we can see when the constructors and the destructor are called, as well as the overloaded `=` operator. The modified class is shown here, followed by [Program 14-18](#)  which demonstrates the class.

## Contents of `Person.h`

```
1  #ifndef PERSON_H
2  #define PERSON_H
3  #include <iostream>
4  #include <cstring>
5  using namespace std;
6
7  class Person
8  {
9  private:
10     char *name;
11 public:
12     // Default constructor
13     Person()
14     { cout << "*** default constructor ***\n";
15       name = nullptr; }
16
17
18     // Constructor with a parameter
19     Person(char *n)
20     { cout << "*** parameterized constructor
21       ***\n";
22       name = new char[strlen(n) + 1];
23       strcpy(name, n); }
24 }
```

```
24 // Copy constructor
25 Person(const Person &obj)
26 { cout << "*** copy constructor ***\n";
27   name = new char[strlen(obj.name) + 1];
28   strcpy(name, obj.name); }
29
30 // Destructor
31 ~Person()
32 { cout << "*** destructor ***\n";
33   delete [] name; }
34
35 // Overloaded = operator
36 Person & operator=(const Person &right)
37 { cout << "*** assignment operator ***\n";
38   if (this != &right)
39   {
40     if (name != nullptr)
41       delete[] name;
42     name = new char[strlen(right.name) +
43   1];
44     strcpy(name, right.name);
45   }
46   return *this; }
47
48 // getName member function
49 char *getName() const
50 { return name; }
```

```
50  };
```

```
51  #endif
```

## Program 14-18

```
1  #include <iostream>
2  #include <string>
3  #include "Person.h"
4  using namespace std;
5
6  // Function prototype
7  Person makePerson();
8  void displayPerson(Person);
9
10 int main()
11 {
12     Person person;
13     person = makePerson();
14     displayPerson(person);
15     return 0;
16 }
17
18 Person makePerson()
19 {
20     Person p("Will MacKenzie");
21     return p;
22 }
23
```

```
24 void displayPerson(Person p2)
25 {
26     cout << p2.getName() << endl;
27 }
```

## Program Output

```
*** default constructor ***
(1) Object named person created in main
*** parameterized constructor ***
(2) Object named p created in makePerson
*** copy constructor ***
(3) Temporary object created as a copy of p
*** destructor ***
(4) Object p destroyed
*** assignment operator ***
(5) Temporary object assigned to person in
main
*** destructor ***
(6) Temporary object destroyed
*** copy constructor ***
(7) p2 parameter object in displayPerson
Will MacKenzie
(8) Displayed by the cout statement in line
26
*** destructor ***
(9) p2 parameter object destroyed
*** destructor ***
(10) person object in main destroyed
```

In the program's output, the comments that are shown to the right, in a different color, are not part of the output. We have added those so

we can refer to specific lines in our discussion.

Let's step through the execution of the program, and take a closer look at its output:

- In the `main` function, the statement in line 12 creates a local `Person` object named `person`. This statement causes the `Person` class's default constructor to execute, displaying the output in line (1).
- Line 13 calls the `makePerson` function. Inside the `makePerson` function, the statement in line 20 creates a `Person` object named `p`, passing "Will MacKenzie" to the constructor. This causes the output in line (2) to be displayed.
- In line 21, the `makePerson` function returns the `Person` object named `p`. Before the function terminates, however, a temporary object is created, as a copy of the `p` object. This causes the temporary object's copy constructor to be called, displaying the output in line (3).
- As the `makePerson` function terminates, the `p` object is destroyed, causing the output in line (4) to be displayed.
- In line 13, the temporary object is assigned to the `person` object. This causes the `Person` class's overloaded `=` operator to be called, displaying the output in line (5).
- The temporary object is destroyed, causing the `Person` class's destructor to be called. This displays the output in line (6).
- Line 14 calls the `displayPerson` function, passing the `person` object as an argument.



- In line 24, the `p2` parameter object is created as a copy of the `person` object. This calls the copy constructor, and displays the output in line (7).
- Line 26 displays the output shown in line (8).
- The `displayPerson` function terminates, causing the `p2` parameter to be destroyed. This calls the `Person` class's destructor, displaying the output in line (9).
- In `main`, line 15 ends the program, causing the `person` object to be destroyed. The output in line (10) is displayed by the `Person` class's destructor.

We are especially interested in line 13:


```
    person = makePerson();  
that calls the makePerson() function:  
    Person makePerson()  
{  
    Person p("Will MacKenzie");  
    return p;  
}
```

The `makePerson()` function creates a local `Person` object named `p`. When the function returns `p`, a temporary object is created as a copy of `p`. This causes the `Person` class's copy constructor to execute. The copy constructor allocates a block of memory to hold

the `name` array, then copies the `name` array from `p` to the temporary object.

Then in line 13, the overloaded assignment operator executes to copy the temporary object to the `person` object. The overloaded assignment operator also allocates a block of memory, and copies the `name` array from the temporary object to the `person` object. As you can see, the copy assignment goes to great lengths to avoid pointer sharing between the temporary object and the `person` object, but then right after that, the temporary object is destroyed and its `name` array is deleted.

**11** With C++ 11, we can add another assignment operator function, known as a *move assignment* operator, to the `Person` class. The idea behind the move assignment operator is to avoid all this work by simply swapping the members of the object being assigned with the temporary object. That way, when the temporary object is destroyed, its destructor deletes the memory that was previously owned by `person`, and `person` avoids having to copy the elements that were in the temporary object's `name` array.

The move assignment operator function for the `Person` class follows. To simplify the code, we have used the STL library function `swap` to swap the contents of two memory locations. The `swap` function is declared in the `<algorithm>` header file (you will learn more about the functions in the `<algorithm>` header file in [Chapter 17](#) .

```
// Move assignment operator
Person& operator=(Person&& right)
{ if (this != &right)
  {
    swap(name, right.name);
  }
  return *this;
}
```

Compare the class's move assignment operator to the class's copy assignment operator:

```
// Copy assignment operator
Person & operator=(const Person &right)
{ if (this != &right)
  {
    name = new char[strlen(right.name) + 1];
    strcpy(name, right.name);
  }
  return *this;
}
```

Notice the function header for the move assignment operator is different from the function header for the copy assignment operator in two ways:

- The move assignment operator takes an rvalue reference as parameter. This is because a move assignment should only be performed when the source of the assignment is a temporary object.
- The parameter in the move assignment operator is not `const`. This is because “moving” a resource from an object modifies it.

The move assignment, introduced in C++ 11, is much more efficient than copy assignment, and it should be used whenever the object being assigned from is temporary. There is also a *move constructor*, which should be used when creating a new object by initialization from a temporary object.

If you add a move assignment operator to a class, you should also add a *move constructor* to the class. A move constructor avoids unnecessary copying of data by “stealing” it from the temporary object. Here is the move constructor for the `Person` class. Again, note the parameter to the constructor is an rvalue reference, denoting that the parameter is a temporary object.

```
// Move constructor
Person(Person&& temp)
{ // Steal the name pointer from temp.
    name = temp.name;
    // Nullify the temp object's name pointer.
    temp.name = nullptr;
}
```

Note the parameter in the move constructor cannot be `const`. In addition, the temporary object that is the source for the move constructor must be left in a state that will allow its destructor to run without causing errors. That is why, in the `Person` class's move constructor, we set the temporary object's `name` pointer to `nullptr` before the function ends.

# When to Implement Move Semantics in a Class

Anytime you write a class that contains a pointer or a reference to an outside piece of data, you should include a copy constructor, a move constructor, a copy assignment operator, and a move assignment operator. By adding move operations to such a class, you will ensure the best performance for your code.

At runtime, the move constructor and move assignment operator are automatically called when appropriate. Specifically, the compiler uses a move operation whenever an object is being assigned the value of a temporary object, or initialized with a copy of a temporary object.

# Default Operations Provided by the Compiler

The motivation for writing copy constructors, move constructors, copy assignment operators, move assignment operators, and destructors is to make sure a class properly manages and disposes of resources, such as dynamically allocated memory. Writing all of these operations for each class can be tedious, so the compiler tries to help out by generating default implementations for them. Let's assume we compile the following class:

```
class MyClass
{
private:
    int mydata = 0;
public:
    int getMyData()
    { return mydata; }
    void setMyData(int d)
    { mydata = d; }
};
```

The compiler will automatically generate the following:

- A default constructor `MyClass()`
- A copy constructor `MyClass(const MyClass &)`
- A copy assignment operator `MyClass & operator=(const MyClass &)`
- A move constructor `MyClass(MyClass &&)`
- A destructor `~MyClass()`

Keep in mind if you write your own version of *any* of these member functions, the compiler will not provide any of the default versions. So, if you write one of these member functions, you should write all of the others as well. For example, if you write a copy constructor for a class, then you should also write a move constructor, a copy assignment operator, a move assignment operator, and a destructor.



# Review Questions and Exercises

## Short Answer

1. Describe the difference between an instance member variable and a static member variable.
2. Assume a class named `Numbers` has the following static member function declaration:  

```
static void showTotal();
```

Write a statement that calls the `showTotal` function.
3. A static member variable is declared in a class. Where is the static member variable defined?
4. What is a friend function?
5. Why is it not always a good idea to make an entire class a friend of another class?
6. What is memberwise assignment?
7. When is a copy constructor called?
8. How can the compiler determine if a constructor is a copy constructor?
9. Describe a situation where memberwise assignment is not desirable.
10. Why must the parameter of a copy constructor be a reference?
11. What is a default copy constructor?

12. Why would a programmer want to overload operators rather than use regular member functions to perform similar operations?
13. What is passed to the parameter of a class's `operator=` function?
14. Why shouldn't a class's overloaded `=` operator be implemented with a `void` operator function?
15. How does the compiler know whether an overloaded `++` operator should be used in prefix or postfix mode?
16. What is the `this` pointer?
17. What type of value should be returned from an overloaded relational operator function?
18. The class `Stuff` has both a copy constructor and an overloaded `=` operator. Assume `blob` and `clump` are both instances of the `Stuff` class. For each statement below, indicate whether the copy constructor or the overloaded `=` operator will be called:

```
Stuff blob = clump;  
clump = blob;  
blob.operator=(clump);  
showValues(blob); // blob is passed by value.
```

19. Explain the programming steps necessary to make a class's member variable static.
20. Explain the programming steps necessary to make a class's member function static.

21. Consider the following class declaration:

```
class Thing
{
private:
    int x;
    int y;
    static int z;
public:
    Thing()
        { x = y = z; }
    static void putThing(int a)
        { z = a; }
};
```

Assume a program containing the class declaration defines three `Thing` objects with the following statement:

```
Thing one, two, three;
```

How many separate instances of the `x` member exist?

How many separate instances of the `y` member exist?

How many separate instances of the `z` member exist?

What value will be stored in the `x` and `y` members of each object?

Write a statement that will call the `PutThing` member function *before* the objects above are defined.

22. Describe the difference between making a class a member of another class (object aggregation), and making a class a

friend of another class.

23. What is the purpose of a forward declaration of a class?
24. Explain why memberwise assignment can cause problems with a class that contains a pointer member.
25. Why is a class's copy constructor called when an object of that class is passed by value into a function?

# Fill-in-the-Blank

26. If a member variable is declared \_\_\_\_\_, all objects of that class have access to the same variable.
27. Static member variables are defined \_\_\_\_\_ the class.
28. A(n) \_\_\_\_\_ member function cannot access any nonstatic member variables in its own class.
29. A static member function may be called \_\_\_\_\_ any instances of its class are defined.
30. A(n) \_\_\_\_\_ function is not a member of a class, but has access to the private members of the class.
31. A(n) \_\_\_\_\_ tells the compiler that a specific class will be declared later in the program.
32. \_\_\_\_\_ is the default behavior when an object is assigned the value of another object of the same class.
33. A(n) \_\_\_\_\_ is a special constructor, called whenever a new object is initialized with another object's data.
34. \_\_\_\_\_ is a special built-in pointer that is automatically passed as a hidden argument to all nonstatic member functions.
35. An operator may be \_\_\_\_\_ to work with a specific class.
36. When overloading the \_\_\_\_\_ operator, its function must have a dummy parameter.
37. Making an instance of one class a member of another class is called \_\_\_\_\_.
38. Object aggregation is useful for creating a(n) \_\_\_\_\_ relationship between two classes.

# Algorithm Workbench

39. Assume a class named `Bird` exists. Write the header for a member function that overloads the `=` operator for that class.
40. Assume a class named `Dollars` exists. Write the headers for member functions that overload the prefix and postfix `++` operators for that class.
41. Assume a class named `Yen` exists. Write the header for a member function that overloads the `<` operator for that class.
42. Assume a class named `Length` exists. Write the header for a member function that overloads `cout`'s `<<` operator for that class.
43. Assume a class named `Collection` exists. Write the header for a member function that overloads the `[]` operator for that class.

# True or False

44. T F Static member variables cannot be accessed by nonstatic member functions.
45. T F Static member variables are defined outside their class declaration.
46. T F A static member function may refer to nonstatic member variables of the same class, but only after an instance of the class has been defined.
47. T F When a function is declared a `friend` by a class, it becomes a member of that class.
48. T F A `friend` function has access to the private members of the class declaring it a `friend`.
49. T F An entire class may be declared a `friend` of another class.
50. T F In order for a function or class to become a friend of another class, it must be declared as such by the class granting it access.
51. T F If a class has a pointer as a member, it's a good idea to also have a copy constructor.
52. T F You cannot use the = operator to assign one object's values to another object, unless you overload the operator.
53. T F If a class doesn't have a copy constructor, the compiler generates a default copy constructor for it.
54. T F If a class has a copy constructor, and an object of that class is passed by value into a function, the function's parameter will *not* call its copy constructor.

55. T F The `this` pointer is passed to static member functions.
56. T F All functions that overload unary operators must have a dummy parameter.
57. T F For an object to perform automatic type conversion, an operator function must be written.
58. T F It is possible to have an instance of one class as a member of another class.



# Find the Errors

Each of the following class declarations has errors. Locate as many as you can.

59.

```
class Box
{
    private:
        double width;
        double length;
        double height;

    public:
        Box(double w, l, h)
            { width = w; length = l; height = h; }

        Box(Box b) // Copy constructor
            { width = b.width;
              length = b.length;
              height = b.height; }

        ... Other member functions follow ...

};
```

60.

```
class Circle
{
    private:
        double diameter;
        int centerX;
        int centerY;
    public:
        Circle(double d, int x, int y)
            { diameter = d; centerX = x; centerY = y; }
        // Overloaded = operator
        void Circle=(Circle &right)
            { diameter = right.diameter;
              centerX = right.centerX;
              centerY = right.centerY; }
        ... Other member functions follow ...
};
```

61.

```
class Point
{
    private:
        int xCoord;
        int yCoord;
    public:
        Point (int x, int y)
            { xCoord = x; yCoord = y; }
        // Overloaded + operator
        void operator+(const &Point right)
            { xCoord += right.xCoord;
              yCoord += right.yCoord;
            }
        ... Other member functions follow ...
};
```

62.

```
class Box
{
    private:
        double width;
        double length;
        double height;
    public:
        Box(double w, l, h)
            { width = w; length = l; height = h; }
        // Overloaded prefix ++ operator
        void operator++()
            { ++width; ++length;}
        // Overloaded postfix ++ operator
        void operator++()
            { width++; length++;}
        ... Other member functions follow ...
};
```

63.

```
class Yard
{
    private:
        float length;
    public:
        yard(float l)
            { length = l; }
        // float conversion function
        void operator float()
            { return length; }
        ... Other member functions follow ...
};
```

# Programming Challenges

## 1. `Numbers` Class

Design a class `Numbers` that can be used to translate whole dollar amounts in the range 0 through 9999 into an English description of the number. For example, the number 713 would be translated into the string *seven hundred thirteen*, and 8203 would be translated into *eight thousand two hundred three*. The class should have a single integer member variable:

```
int number;
```

and a static array of `string` objects that specify how to translate key dollar amounts into the desired format. For example, you might use static strings such as

```
string lessThan20[20] = {"zero", "one", ..., "eighteen",  
"nineteen"};  
string hundred = "hundred";  
string thousand = "thousand";
```

The class should have a constructor that accepts a nonnegative integer and uses it to initialize the `Numbers` object. It should have a member function `print()` that prints the English description of the `Numbers` object. Demonstrate the class by writing a main program that asks the user to

enter a number in the proper range then prints out its English description.

## 2. Day of the Year

Assuming a year has 365 days, write a class named `DayOfYear` that takes an integer representing a day of the year and translates it to a string consisting of the month followed by day of the month. For example, Day 2 would be *January 2*.

Day 32 would be *February 1*.

Day 365 would be *December 31*.

The constructor for the class should take as parameter an integer representing the day of the year, and the class should have a member function `print()` that prints the day in the month–day format. The class should have an integer member variable to represent the day, and should have static member variables holding `string` objects that can be used to assist in the translation from the integer format to the month–day format.

Test your class by inputting various integers representing days and printing out their representation in the month–day format.

## 3. Day of the Year Modification

Modify the `DayOfYear` class, written in Programming Challenge 2, to add a constructor that takes two parameters: a `string` object representing a month and an integer in the range 0 through 31 representing the day of the month. The

constructor should then initialize the integer member of the class to represent the day specified by the month and day of month parameters. The constructor should terminate the program with an appropriate error message if the number entered for a day is outside the range of days for the month given.

Add the following overloaded operators:

#### 4. `NumDays` Class



### Solving the NumDays Problem

Design a class called `NumDays`. The class's purpose is to store a value that represents a number of work hours and convert it to a number of days. For example, 8 hours would be converted to 1 day, 12 hours would be converted to 1.5 days, and 18 hours would be converted to 2.25 days. The class should have a constructor that accepts a number of hours, as well as member functions for storing and retrieving the hours and days. The class should also have the following overloaded operators:

#### 5. Time Off





## Note:

This assignment assumes you have already completed Programming Challenge 4.

Design a class named `TimeOff`. The purpose of the class is to track an employee's sick leave, vacation, and unpaid time off. It should have, as members, the following instances of the `NumDays` class described in Programming Challenge 4:

Additionally, the class should have members for holding the employee's name and identification number. It should have an appropriate constructor and member functions for storing and retrieving data in any of the member objects.

*Input Validation: Company policy states that an employee may not accumulate more than 240 hours of paid vacation.*

*The class should not allow the `maxVacation` object to store a value greater than this amount.*

## 6. Personnel Report



## Note:

This assignment assumes you have already completed Programming Challenges 4 and 5.

Write a program that uses an instance of the `TimeOff` class you designed in Programming Challenge 5. The program should ask the user to enter the number of months an employee has worked for the company. It should then use the `TimeOff` object to calculate and display the employee's maximum number of sick leave and vacation days. Employees earn 12 hours of vacation leave and 8 hours of sick leave per month.

## 7. `Month` Class

Design a class named `Month`. The class should have the following private members:


In addition, provide the following member functions:

- A default constructor that sets `monthNumber` to 1 and `name` to "January."
- A constructor that accepts the name of the month as an argument. It should set `name` to the value passed as the argument and set `monthNumber` to the correct value.
- A constructor that accepts the number of the month as an argument. It should set `monthNumber` to the value passed as the argument and set `name` to the correct month name.
- Appropriate set and get functions for the `name` and `monthNumber` member variables.
- Prefix and postfix overloaded ++ operator functions that increment `monthNumber` and set name to the name of next month. If `monthNumber` is set to 12 when these functions execute, they should set `monthNumber` to 1 and `name` to "January."

- Prefix and postfix overloaded `--` operator functions that decrement `monthNumber` and set `name` to the name of previous month. If `monthNumber` is set to 1 when these functions execute, they should set `monthNumber` to 12 and `name` to “December.”

Also, you should overload `cout`'s `<<` operator and `cin`'s `>>` operator to work with the `Month` class. Demonstrate the class in a program.

## 8. `Date` Class Modification

Modify the `Date` class in Programming Challenge 1 of [Chapter 13](#) . The new version should have the following overloaded operators:

The class should detect the following conditions and handle them accordingly:

- When a date is set to the last day of the month and incremented, it should become the first day of the following month.
- When a date is set to December 31 and incremented, it should become January 1 of the following year.
- When a day is set to the first day of the month and decremented, it should become the last day of the previous month.
- When a date is set to January 1 and decremented, it should become December 31 of the previous year.

Demonstrate the class's capabilities in a simple program.

*Input Validation: The overloaded `>>` operator should not accept invalid dates. For example, the date 13/45/2018 should not be accepted.*

## 9. `FeetInches` Modification

Modify the `FeetInches` class discussed in this chapter so it overloads the following operators:

```
<=
```

```
>=
```

```
!=
```

Demonstrate the class's capabilities in a simple program.

## 10. Corporate Sales

A corporation has six divisions, each responsible for sales to different geographic locations. Design a `DivSales` class that keeps sales data for a division, with the following members:

- An array with four elements for holding four quarters of sales figures for the division.
- A private static variable for holding the total corporate sales for all divisions for the entire year.
- A member function that takes four arguments, each assumed to be the sales for a quarter. The value of the arguments should be copied into the array that holds the sales data. The total of the four arguments should be added to the static variable that holds the total yearly corporate sales.

- A function that takes an integer argument within the range of 0–3. The argument is to be used as a subscript into the division quarterly sales array. The function should return the value of the array element with that subscript.

Write a program that creates an array of six `DivSales` objects. The program should ask the user to enter the sales for four quarters for each division. After the data are entered, the program should display a table showing the division sales for each quarter. The program should then display the total corporate sales for the year.

*Input Validation: Only accept positive values for quarterly sales figures.*

11. `FeetInches` **Class Copy Constructor and** `multiply`  
**Function**

Add a copy constructor to the `FeetInches` class. This constructor should accept a `FeetInches` object as an argument. The constructor should assign to the `feet` attribute the value in the argument's `feet` attribute, and assign to the `inches` attribute the value in the argument's `inches` attribute. As a result, the new object will be a copy of the argument object.

Next, add a `multiply` member function to the `FeetInches` class. The `multiply` function should accept a `FeetInches` object as an argument. The argument object's `feet` and `inches` attributes will be multiplied by the calling object's

`feet` and `inches` attributes, and a `FeetInches` object containing the result will be returned.

## 12. `LandTract` Class

Make a `LandTract` class that is composed of two `FeetInches` objects: one for the tract's length, and one for the width. The class should have a member function that returns the tract's area. Demonstrate the class in a program that asks the user to enter the dimensions for two tracts of land. The program should display the area of each tract of land, and indicate whether the tracts are of equal size.

## 13. Carpet Calculator

The Westfield Carpet Company has asked you to write an application that calculates the price of carpeting for rectangular rooms. To calculate the price, you multiply the area of the floor (width times length) by the price per square foot of carpet. For example, the area of floor that is 12 feet long and 10 feet wide is 120 square feet. To cover that floor with carpet that costs \$8 per square foot would cost \$960. ( $12 \times 10 \times 8 = 960$ .)

First, you should create a class named `RoomDimension` that has two `FeetInches` objects as attributes: one for the length of the room, and one for the width. (You should use the version of the `FeetInches` class you created in Programming Challenge 11 with the addition of a `multiply` member function. You can use this function to calculate the area of the room.) The `RoomDimension` class should have a member

function that returns the area of the room as a `FeetInches` object.

Next, you should create a `RoomCarpet` class that has a `RoomDimension` object as an attribute. It should also have an attribute for the cost of the carpet per square foot. The `RoomCarpet` class should have a member function that returns the total cost of the carpet.

Once you have written these classes, use them in an application that asks the user to enter the dimensions of a room and the price per square foot of the desired carpeting. The application should display the total cost of the carpet.

#### 14. Parking Ticket Simulator

For this assignment, you will design a set of classes that work together to simulate a police officer issuing a parking ticket. The classes you should design are:

- **The `ParkedCar` Class:** This class should simulate a parked car. The class's responsibilities are:
  - To know the car's make, model, color, license number, and the number of minutes that the car has been parked
- **The `ParkingMeter` Class:** This class should simulate a parking meter. The class's only responsibility is:
  - To know the number of minutes of parking time that has been purchased
- **The `ParkingTicket` Class:** This class should simulate a parking ticket. The class's responsibilities are:
  - To report the make, model, color, and license number of the illegally parked car

- To report the amount of the fine, which is \$25 for the first hour or part of an hour that the car is illegally parked, plus \$10 for every additional hour or part of an hour that the car is illegally parked
- To report the name and badge number of the police officer issuing the ticket
- **The `PoliceOfficer` Class:** This class should simulate a police officer inspecting parked cars. The class's responsibilities are:
  - To know the police officer's name and badge number
  - To examine a `ParkedCar` object and a `ParkingMeter` object, and determine whether the car's time has expired
  - To issue a parking ticket (generate a `ParkingTicket` object) if the car's time has expired

Write a program that demonstrates how these classes collaborate.

## 15. Car Instrument Simulator

For this assignment you will design a set of classes that work together to simulate a car's fuel gauge and odometer. The classes you will design are:

- **The `FuelGauge` Class:** This class will simulate a fuel gauge. Its responsibilities are
  - To know the car's current amount of fuel, in gallons.
  - To report the car's current amount of fuel, in gallons.



- To be able to increment the amount of fuel by 1 gallon. This simulates putting fuel in the car. (The car can hold a maximum of 15 gallons.)
- To be able to decrement the amount of fuel by 1 gallon, if the amount of fuel is greater than 0 gallons. This simulates burning fuel as the car runs.
- **The `Odometer` Class:** This class will simulate the car's odometer. Its responsibilities are:
  - To know the car's current mileage.
  - To report the car's current mileage.
  - To be able to increment the current mileage by 1 mile. The maximum mileage the odometer can store is 999,999 miles. When this amount is exceeded, the odometer resets the current mileage to 0.
  - To be able to work with a `FuelGauge` object. It should decrease the `FuelGauge` object's current amount of fuel by 1 gallon for every 24 miles traveled. (The car's fuel economy is 24 miles per gallon.)

Demonstrate the classes by creating instances of each. Simulate filling the car up with fuel, then run a loop that increments the odometer until the car runs out of fuel. During each loop iteration, print the car's current mileage and amount of fuel.

---

# Chapter **15** Inheritance, Polymorphism, and Virtual Functions

---

## Topics

**15.1 What Is Inheritance?** [📄](#)

**15.2 Protected Members and Class Access** [📄](#)

**15.3 Constructors and Destructors in Base and Derived Classes** [📄](#)

**15.4 Redefining Base Class Functions** [📄](#)

**15.5 Class Hierarchies** [📄](#)

**15.6 Polymorphism and Virtual Member Functions** [📄](#)

**15.7 Abstract Base Classes and Pure Virtual Functions** [📄](#)

**15.8 Multiple Inheritance** [📄](#)

## 15.1 What Is Inheritance?

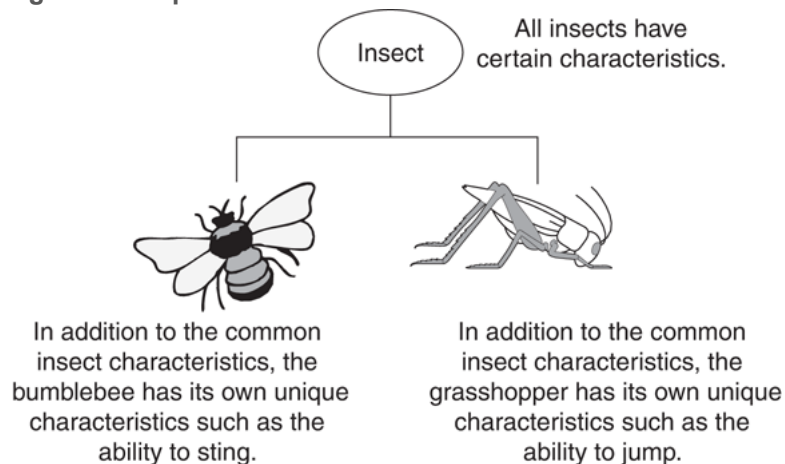
### Concept:

Inheritance allows a new class to be based on an existing class. The new class automatically inherits all the member variables and functions, except the constructors and destructor, of the class it is based on. (In C++ 11, a class can optionally inherit some of the constructors of the class it is based on.)

## Generalization and Specialization

In the real-world, you can find many objects that are specialized versions of other more general objects. For example, the term “insect” describes a very general type of creature with numerous characteristics. Because grasshoppers and bumblebees are insects, they have all the general characteristics of an insect. In addition, they have special characteristics of their own. For example, the grasshopper has its jumping ability, and the bumblebee has its stinger. Grasshoppers and bumblebees are specialized versions of an insect. This is illustrated in [Figure 15-1](#).

**Figure 15-1 Specialized versions of an insect**



# Inheritance and the “Is a” Relationship

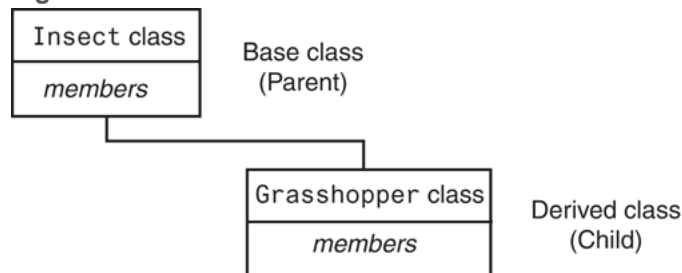
When one object is a specialized version of another object, there is an “*is a*” relationship between them. For example, a grasshopper *is an* insect. Here are a few other examples of the “is a” relationship:

- A poodle *is a* dog.
- A car *is a* vehicle.
- A tree *is a* plant.
- A rectangle *is a* shape.
- A football player *is an* athlete.

When an “is a” relationship exists between classes, it means that the specialized class has all of the characteristics of the general class, plus additional characteristics that make it special. In object-oriented programming, *inheritance* is used to create an “is a” relationship between classes.

Inheritance involves a base class and a derived class. The *base class* is the general class and the *derived class* is the specialized class. The derived class is based on, or derived from, the base class. You can think of the base class as the parent, and the derived class as the child. This is illustrated in [Figure 15-2](#).

**Figure 15-2 Base class and derived class**



The derived class inherits the member variables and member functions of the base class without any of them being rewritten. Furthermore, new member variables and functions may be added to the derived class to make it more specialized than the base class.

Let’s look at an example of how inheritance can be used. Most teachers assign various graded activities for their students to complete. A graded activity can receive a numeric score such as 70, 85, 90, and so on, and a letter grade such as A, B, C, D, or F. The following `GradedActivity` class is designed to hold the numeric score and letter grade of a graded activity. When a numeric score is stored by the class, it automatically determines the letter grade. (These files can be found in the Student Source Code Folder [Chapter 15](#) \GradedActivity Version 1.)

## Contents of GradedActivity.h (Version 1)

```
1 #ifndef GRADEDACTIVITY_H
2 #define GRADEDACTIVITY_H
3
4 // GradedActivity class declaration
5
6 class GradedActivity
7 {
8 private:
9     double score; // To hold the numeric score
10 public:
11     // Default constructor
12     GradedActivity()
13         { score = 0.0; }
14
15     // Constructor
16     GradedActivity(double s)
17         { score = s; }
18
19     // Mutator function
20     void setScore(double s)
21         { score = s; }
22
23     // Accessor functions
24     double getScore() const
25         { return score; }
26
27     char getLetterGrade() const;
28 };
29 #endif
```

## Contents of `GradedActivity.cpp` (Version 1)

```
1 #include "GradedActivity.h"
2
3 //*****
4 // Member function GradedActivity::getLetterGrade *
5 //*****
6
7 char GradedActivity::getLetterGrade() const
8 {
9     char letterGrade; // To hold the letter grade
10
11     if (score > 89)
12         letterGrade = 'A';
13     else if (score > 79)
14         letterGrade = 'B';
15     else if (score > 69)
16         letterGrade = 'C';
17     else if (score > 59)
18         letterGrade = 'D';
19     else
20         letterGrade = 'F';
21
22     return letterGrade;
23 }
```

The `GradedActivity` class has a default constructor that initializes the `score` member variable to 0.0. A second constructor accepts an argument for `score`. The `setScore` member function also accepts an argument for the `score` variable, and the `getLetterGrade` member function returns the letter grade that corresponds to the value in `score`. [Program 15-1](#) demonstrates the `GradedActivity` class. (This file can also be found in the Student Source Code Folder [Chapter 15](#)\GradedActivity Version 1.)

## Program 15-1

```
1 // This program demonstrates the GradedActivity class.
2 #include <iostream>
3 #include "GradedActivity.h"
4 using namespace std;
5
6 int main()
7 {
8     double testScore; // To hold a test score
9
10    // Create a GradedActivity object for the test.
11    GradedActivity test;
12
13    // Get a numeric test score from the user.
14    cout << "Enter your numeric test score: ";
15    cin >> testScore;
16
17    // Store the numeric score in the test object.
18    test.setScore(testScore);
19
20    // Display the letter grade for the test.
21    cout << "The grade for that test is "
22         << test.getLetterGrade() << endl;
23
24    return 0;
25 }
```

### Program Output with Example Input Shown in Bold

```
Enter your numeric test score: 89 Enter
The grade for that test is B
```

### Program Output with Different Example Input Shown in Bold

```
Enter your numeric test score: 75 Enter
The grade for that test is C
```

The `GradedActivity` class represents the general characteristics of a student's graded activity. Many different types of graded activities exist, however, such as quizzes, midterm exams, final exams, lab reports, essays, and so on. Because the numeric scores might be determined differently for each of these graded activities, we can create derived classes to handle each one. For example, the following code shows the `FinalExam` class, which is derived from the `GradedActivity` class. It has member variables for the number of questions on the exam (`numQuestions`), the number of points each question is worth (`pointsEach`), and the number of questions missed by the student (`numMissed`). These files can be found in the Student Source Code Folder [Chapter 15](#) \GradedActivity Version 1.



## Contents of `FinalExam.h`

```
1 #ifndef FINALEXAM_H
2 #define FINALEXAM_H
3 #include "GradedActivity.h"
4
5 class FinalExam : public GradedActivity
6 {
7     private:
8         int numQuestions; // Number of questions
9         double pointsEach; // Points for each question
10        int numMissed; // Number of questions missed
11    public:
12        // Default constructor
13        FinalExam()
14            { numQuestions = 0;
15              pointsEach = 0.0;
16              numMissed = 0; }
17
18        // Constructor
19        FinalExam(int questions, int missed)
20            { set(questions, missed); }
21
22        // Mutator function
23        void set(int, int); // Defined in FinalExam.cpp
24
25        // Accessor functions
26        double getNumQuestions() const
27            { return numQuestions; }
28
29        double getPointsEach() const
30            { return pointsEach; }
31
32        int getNumMissed() const
33            { return numMissed; }
```

```
34 };
35 #endif
```

## Contents of `FinalExam.cpp`

```
1 #include "FinalExam.h"
2
3 /*******
4 // set function *
5 // The parameters are the number of questions and the *
6 // number of questions missed. *
7 /*******
8
9 void FinalExam::set(int questions, int missed)
10 {
11     double numericScore; // To hold the numeric score
12
13     // Set the number of questions and number missed.
14     numQuestions = questions;
15     numMissed = missed;
16
17     // Calculate the points for each question.
18     pointsEach = 100.0 / numQuestions;
19
20     // Calculate the numeric score for this exam.
21     numericScore = 100.0 - (missed * pointsEach);
22
23     // Call the inherited setScore function to set
24     // the numeric score.
25     setScore(numericScore);
26 }
```

The only new notation in this code is in line 5 of the `FinalExam.h` file, which reads

```
class FinalExam : public GradedActivity
```

This line indicates the name of the class being declared and the name of the base class it is derived from. `FinalExam` is the name of the class being declared, and `GradedActivity` is the name of the base class it inherits from.

If we want to express the relationship between the two classes, we can say a `FinalExam` is a `GradedActivity`.

The word `public`, which precedes the name of the base class in line 5 of the `FinalExam.h` file, is the *base class access specification*. It affects how the members of the base class are inherited by the derived class. When you create an object of a derived class, you can think of it as being built on top of an object of the base class. The members of the base class object become members of the derived class object. How the base class members appear in the derived class is determined by the base class access specification.

Although we will discuss this topic in more detail in the next section, let's see how it works in this example. The `GradedActivity` class has both private members and public members. The `FinalExam` class is derived from the `GradedActivity` class, using `public` access specification. This means that the public members of the `GradedActivity` class will become public members of the `FinalExam` class. The private members of the `GradedActivity` class cannot be accessed directly by code in the `FinalExam` class. Although the private members of the `GradedActivity` class are inherited, it's as though they are invisible to the code in the `FinalExam` class. They can only be accessed by the member functions of the `GradedActivity` class. Here is a list of the members of the `FinalExam` class:

The `GradedActivity` class has one private member, the variable `score`. Notice it is not listed as a member of the `FinalExam` class. It is still inherited by the derived class, but because it is a private member of the base class, only member functions of the base class may access it. It is truly private to the base class. Because the functions `setScore`, `getScore`, and `getLetterGrade` are public members of the base class, they also become public members of the derived class.


You will also notice the `GradedActivity` class constructors are not listed among the members of the `FinalExam` class. Although the base class constructors still exist, it makes sense that they are not members of the derived class because their purpose is to construct objects of the base class. In the next section, we discuss in more detail how base class constructors operate.

Let's take a closer look at the `FinalExam` class constructors. The default constructor appears in lines 13 through 16 of the `FinalExam.h` file. It simply assigns 0 to each of the class's member variables. Another constructor appears in lines 19 and 20. This constructor accepts two arguments: one for the number of

questions on the exam, and one for the number of questions missed. This constructor merely passes those values as arguments to the `set` function.

The `set` function is defined in `FinalExam.cpp`. It accepts two arguments: the number of questions on the exam, and the number of questions missed by the student. In lines 14 and 15, these values are assigned to the `numQuestions` and `numMissed` member variables. In line 18, the number of points for each question is calculated. In line 21, the numeric test score is calculated. In line 25, the last statement in the function reads:

```
setScore(numericScore);
```

This is a call to the `setScore` function. Although no `setScore` function appears in the `FinalExam` class, it is inherited from the `GradedActivity` class. [Program 15-2](#)  demonstrates the `FinalExam` class.

## Program 15-2

```
1 // This program demonstrates a base class and a derived class.
2 #include <iostream>
3 #include <iomanip>
4 #include "FinalExam.h"
5 using namespace std;
6
7 int main()
8 {
9     int questions; // Number of questions on the exam
10    int missed;    // Number of questions missed by the student
11
12    // Get the number of questions on the final exam.
13    cout << "How many questions are on the final exam? ";
14    cin >> questions;
15
16    // Get the number of questions the student missed.
17    cout << "How many questions did the student miss? ";
18    cin >> missed;
19
20    // Define a FinalExam object and initialize it with
21    // the values entered.
22    FinalExam test(questions, missed);
23
24    // Display the test results.
25    cout << setprecision(2);
26    cout << "\nEach question counts " << test.getPointsEach()
27           << " points.\n";
28    cout << "The exam score is " << test.getScore() << endl;
29    cout << "The exam grade is " << test.getLetterGrade() << endl;
30
31    return 0;
32 }
```

**Program Output with Example Input Shown in Bold**

```
How many questions are on the final exam? 20 Enter
How many questions did the student miss? 3 Enter

Each question counts 5 points.
The exam score is 85
The exam grade is B
```

Notice in lines 28 and 29, the public member functions of the `GradedActivity` class may be directly called by the `test` object:

```
cout << "The exam score is " << test.getScore() << endl;
cout << "The exam grade is " << test.getLetterGrade() << endl;
```

The `getScore` and `getLetterGrade` member functions are inherited as public members of the `FinalExam` class, so they may be accessed like any other public member.

Inheritance does not work in reverse. It is not possible for a base class to call a member function of a derived class. For example, the following classes will not compile in a program because the `BadBase` constructor attempts to call a function in its derived class:

```
class BadBase
{
private:
    int x;
public:
    BadBase() { x = getVal(); } // Error!
};

class Derived : public BadBase
{
private:
    int y;
public:
    Derived(int z) { y = z; }
    int getVal() { return y; }
};
```



15.1 Here is the first line of a class declaration. What is the name of the base class?

```
class Truck : public Vehicle
```

15.2 What is the name of the derived class in the following declaration line?

```
class Truck : public Vehicle
```

15.3 Suppose a program has the following class declarations:

```
class Shape
{
private:
    double area;
public:
    void setArea(double a)
        { area = a; }
    double getArea()
        { return area; }
};
class Circle : public Shape
{
private:
    double radius;
public:
    void setRadius(double r)
        { radius = r;
          setArea(3.14 * r * r); }
    double getRadius()
        { return radius; }
};
```

Answer the following questions concerning these classes:

- When an object of the `Circle` class is created, what are its private members?
- When an object of the `Circle` class is created, what are its public members?
- What members of the `Shape` class are not accessible to member functions of the `Circle` class?

## 15.2 Protected Members and Class Access

### Concept:

Protected members of a base class are like private members, but they may be accessed by derived classes. The base class access specification determines how private, public, and protected base class members are accessed when they are inherited by the derived classes.

Until now, you have used two access specifications within a class: `private` and `public`. C++ provides a third access specification, `protected`. Protected members of a base class are like private members, except they may be accessed by functions in a derived class. To the rest of the program, however, protected members are inaccessible.

The following code shows a modified version of the `GradedActivity` class declaration. The private member of the class has been made protected. This file can be found in the Student Source Code Folder [Chapter 15](#) \GradedActivity Version 2. The implementation file, `GradedActivity.cpp` has not changed, so it is not shown again in this example.



## Contents of `GradedActivity.h` (Version 2)

```
1 #ifndef GRADEDACTIVITY_H
2 #define GRADEDACTIVITY_H
3
4 // GradedActivity class declaration
5
6 class GradedActivity
7 {
8     protected:
9         double score; // To hold the numeric score
10    public:
11        // Default constructor
12        GradedActivity()
13            { score = 0.0; }
14
15        // Constructor
16        GradedActivity(double s)
17            { score = s; }
18
19        // Mutator function
20        void setScore(double s)
21            { score = s; }
22
23        // Accessor functions
24        double getScore() const
25            { return score; }
26
27        char getLetterGrade() const;
28    };
29 #endif
```

Now we will look at a modified version of the `FinalExam` class, which is derived from this version of the `GradedActivity` class. This version of the `FinalExam` class has a new member function named `adjustScore`. This function directly accesses the `GradedActivity` class's `score` member variable. If the content of the `score` variable has a fractional part of 0.5 or greater, the function rounds `score` up to

the next whole number. The `set` function calls the `adjustScore` function after it calculates the numeric score. (These files are available in the Student Source Code Folder [Chapter 15](#) \GradedActivity Version 2.)

## Contents of `FinalExam.h` (Version 2)

```
1 #ifndef FINALEXAM_H
2 #define FINALEXAM_H
3 #include "GradedActivity.h"
4
5 class FinalExam : public GradedActivity
6 {
7     private:
8         int numQuestions; // Number of questions
9         double pointsEach; // Points for each question
10        int numMissed; // Number of questions missed
11    public:
12        // Default constructor
13        FinalExam()
14            { numQuestions = 0;
15              pointsEach = 0.0;
16              numMissed = 0; }
17
18        // Constructor
19        FinalExam(int questions, int missed)
20            { set(questions, missed); }
21
22        // Mutator functions
23        void set(int, int); // Defined in FinalExam.cpp
24        void adjustScore(); // Defined in FinalExam.cpp
25
26        // Accessor functions
27        double getNumQuestions() const
28            { return numQuestions; }
29
30        double getPointsEach() const
31            { return pointsEach; }
32
33        int getNumMissed() const
34            { return numMissed; }
```



```
35 };
```

```
36 #endif
```

## Contents of `FinalExam.cpp` (Version 2)

```
1  #include "FinalExam.h"
2
3  //*****
4  // set function *
5  // The parameters are the number of questions and the *
6  // number of questions missed. *
7  //*****
8
9  void FinalExam::set(int questions, int missed)
10 {
11     double numericScore; // To hold the numeric score
12
13     // Set the number of questions and number missed.
14     numQuestions = questions;
15     numMissed = missed;
16
17     // Calculate the points for each question.
18     pointsEach = 100.0 / numQuestions;
19
20     // Calculate the numeric score for this exam.
21     numericScore = 100.0 - (missed * pointsEach);
22
23     // Call the inherited setScore function to set
24     // the numeric score.
25     setScore(numericScore);
26
27     // Call the adjustScore function to adjust
28     // the score.
29     adjustScore();
30 }
31
32 //*****
33 // Definition of Test::adjustScore. If score is within *
34 // 0.5 points of the next whole point, it rounds the score up *
35 // and recalculates the letter grade. *
36 //*****
37
```

```
38 void FinalExam::adjustScore()
39 {
40     double fraction = score - static_cast<int>(score);
41
42     if (fraction >= 0.5)
43     {
44         // Adjust the score variable in the GradedActivity class.
45         score += (1.0 - fraction);
46     }
47 }
```

**Program 15-3**  demonstrates these versions of the `GradedActivity` and `FinalExam` classes. (This file can be found in the Student Source Code Folder **Chapter 15**  \GradedActivity Version 2.)

## Program 15-3

```
1 // This program demonstrates a base class with a
2 // protected member.
3 #include <iostream>
4 #include <iomanip>
5 #include "FinalExam.h"
6 using namespace std;
7
8 int main()
9 {
10     int questions; // Number of questions on the exam
11     int missed;    // Number of questions missed by the student
12
13     // Get the number of questions on the final exam.
14     cout << "How many questions are on the final exam? ";
15     cin >> questions;
16
17     // Get the number of questions the student missed.
18     cout << "How many questions did the student miss? ";
19     cin >> missed;
20
21     // Define a FinalExam object and initialize it with
22     // the values entered.
23     FinalExam test(questions, missed);
24
25     // Display the adjusted test results.
26     cout << setprecision(2) << fixed;
27     cout << "\nEach question counts "
28         << test.getPointsEach() << " points.\n";
29     cout << "The adjusted exam score is "
30         << test.getScore() << endl;
31     cout << "The exam grade is "
32         << test.getLetterGrade() << endl;
33
34     return 0;
35 }
```

### Program Output with Example Input Shown in Bold

```
How many questions are on the final exam? 16 Enter
```

```
How many questions did the student miss? 5 Enter
```

```
Each question counts 6.25 points.
```

```
The adjusted exam score is 69.00
```

```
The exam grade is D
```

The program works as planned. In the example run, the student missed five questions, which are worth 6.25 points each. The unadjusted score would be 68.75. The score was adjusted to 69.



# More about Base Class Access Specification

The first line of the `FinalExam` class declaration reads:

```
class FinalExam : public GradedActivity
```

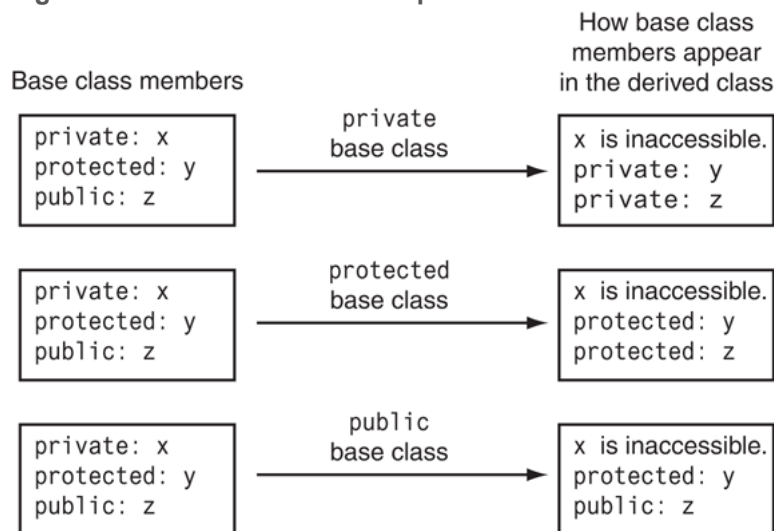
This declaration gives public access specification to the base class. Recall from our earlier discussion that base class access specification affects how inherited base class members are accessed. Be careful not to confuse base class access specification with member access specification. Member access specification determines how members that are *defined* within the class are accessed. Base class access specification determines how *inherited* members are accessed.

When you create an object of a derived class, it inherits the members of the base class. The derived class can have its own private, protected, and public members, but what is the access specification of the inherited members? This is determined by the base class access specification. [Table 15-1](#) summarizes how base class access specification affects the way that base class members are inherited.

**Table 15-1 Base Class Access Specification**

As you can see from [Table 15-1](#), class access specification gives you a great deal of flexibility in determining how base class members will appear in the derived class. Think of a base class's access specification as a filter that base class members must pass through when becoming inherited members of a derived class. This is illustrated in [Figure 15-3](#).

**Figure 15-3 Base class access specification**





**Note:**

If the base class access specification is left out of a declaration, the default access specification is `private`. For example, in the following declaration, `Grade` is declared as a `private` base class:

```
class Test : Grade
```



15.4 What is the difference between private members and protected members?

15.5 What is the difference between member access specification and class access specification?

15.6 Suppose a program has the following class declaration:

```
// Declaration of CheckPoint class.  
class CheckPoint  
{  
    private:  
        int a;  
    protected:  
        int b;  
        int c;  
        void setA(int x) { a = x;}  
    public:  
        void setB(int y) { b = y;}  
        void setC(int z) { c = z;}  
};
```

Answer the following questions regarding the class:

A. Suppose another class, `Quiz`, is derived from the `CheckPoint` class. Here is the first line of its declaration:

```
class Quiz : private CheckPoint
```

Indicate whether each member of the `CheckPoint` class is `private`, `protected`, `public`, or inaccessible:

```
a  
b  
c  
setA  
setB  
setC
```

B. Suppose the `Quiz` class, derived from the `CheckPoint` class, is declared as

```
class Quiz : protected Checkpoint
```

Indicate whether each member of the `Checkpoint` class is `private`, `protected`, `public`, or inaccessible:

```
a  
b  
c  
setA  
setB  
setC
```

C. Suppose the `Quiz` class, derived from the `Checkpoint` class, is declared as

```
class Quiz : public Checkpoint
```

Indicate whether each member of the `Checkpoint` class is `private`, `protected`, `public`, or inaccessible:

```
a  
b  
c  
setA  
setB  
setC
```

D. Suppose the `Quiz` class, derived from the `Checkpoint` class, is declared as


```
class Quiz : Checkpoint
```

Is the `Checkpoint` class a `private`, `public`, or `protected` base class?

## 15.3 Constructors and Destructors in Base and Derived Classes

### Concept:

The base class's constructor is called before the derived class's constructor. The destructors are called in reverse order, with the derived class's destructor being called first.

In inheritance, the base class constructor is called before the derived class constructor. Destructors are called in reverse order. **Program 15-4**  shows a simple set of demonstration classes, each with a default constructor and a destructor. The `DerivedClass` class is derived from the `BaseClass` class. Messages are displayed by the constructors and destructors to demonstrate when each is called.

## Program 15-4

```
1 // This program demonstrates the order in
which base and
2 // derived class constructors and destructors
are called.
3 #include <iostream>
4 using namespace std;
5
6 //*****
7 // BaseClass declaration *
8 //*****
9
10 class BaseClass
11 {
12 public:
13     BaseClass() // Constructor
14     { cout << "This is the BaseClass
constructor.\n"; }
15
16     ~BaseClass() // Destructor
17     { cout << "This is the BaseClass
destructor.\n"; }
18 };
19
```

```
20 //*****
21 // DerivedClass declaration      *
22 //*****
23
24 class DerivedClass : public BaseClass
25 {
26     public:
27         DerivedClass()    // Constructor
28         { cout << "This is the DerivedClass
29 constructor.\n"; }
29
30         ~DerivedClass()  // Destructor
31         { cout << "This is the DerivedClass
32 destructor.\n"; }
32 };
33
34 //*****
35 // main function                *
36 //*****
37
38 int main()
39 {
40     cout << "We will now define a DerivedClass
41 object.\n";
41
42     DerivedClass object;
42
43
```

```
44     cout << "The program is now going to  
end.\n";  
45     return 0;  
46 }
```

## Program Output

```
We will now define a DerivedClass object.  
This is the BaseClass constructor.  
This is the DerivedClass constructor.  
The program is now going to end.  
This is the DerivedClass destructor.  
This is the BaseClass destructor.
```



# Passing Arguments to Base Class Constructors

In [Program 15-4](#), both the base class and derived class have default constructors, which are called automatically. But what if the base class's constructor takes arguments? What if there is more than one constructor in the base class? The answer to these questions is to let the derived class constructor pass arguments to the base class constructor. For example, consider the following class:

## Contents of `Rectangle.h`

```
1  #ifndef RECTANGLE_H
2  #define RECTANGLE_H
3
4  class Rectangle
5  {
6  private:
7      double width;
8      double length;
9  public:
10     // Default constructor
11     Rectangle()
12         { width = 0.0;
13           length = 0.0; }
14
15     // Constructor #2
16     Rectangle(double w, double len)
17         { width = w;
18           length = len; }
19
20     double getWidth() const
21         { return width; }
22
23     double getLength() const
```

```
24     { return length; }
25
26     double getArea() const
27     { return width * length; }
28 };
29 #endif
```

This class is designed to hold data about a rectangle. It specifies two constructors. The default constructor, in lines 11 through 13, simply initializes the `width` and `length` member variables to 0.0. The second constructor, in lines 16 through 18, takes two arguments, which are assigned to the `width` and `length` member variables. Now let's look at a class that is derived from the `Rectangle` class:

## Contents of `Box.h`

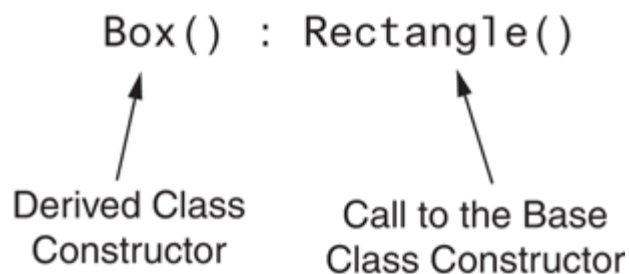
```
1  #ifndef BOX_H
2  #define BOX_H
3  #include "Rectangle.h"
4
5  class Box : public Rectangle
6  {
7  protected:
8      double height;
9      double volume;
10 public:
11     // Default constructor
12     Box() : Rectangle()
13     { height = 0.0; volume = 0.0; }
14
15     // Constructor #2
16     Box(double w, double len, double h) :
17     Rectangle(w, len)
18     { height = h;
19       volume = getArea() * h; }
20
21     double getHeight() const
22     { return height; }
```

```
23     double getVolume() const
24     { return volume; }
25 };
26 #endif
```

The `Box` class is designed to hold data about boxes, which not only have a length and width, but a height and volume as well. Look at line 12, which is the first line of the `Box` class's default constructor:

```
Box() : Rectangle()
```

Notice the added notation in the header of the constructor. A colon is placed after the derived class constructor's parentheses, followed by a function call to a base class constructor. In this case, the base class's default constructor is being called. When this `Box` class constructor executes, it will first call the `Rectangle` class's default constructor. This is illustrated here:



The general format of this type of constructor declaration is

```
ClassName::ClassName(ParameterList) :  
    BaseClassName(ArgumentList)
```

You can also pass arguments to the base class constructor, as shown in the `Box` class's second constructor. Look at line 16:

```
Box(double w, double len, double h) : Rectangle(w, len)
```

This `Box` class constructor has three parameters: `w`, `len`, and `h`. Notice the `Rectangle` class's constructor is called, and the `w` and `len` parameters are passed as arguments. This causes the `Rectangle` class's second constructor to be called.

You only write this notation in the definition of a constructor, not in a prototype. In this example, the derived class constructor is written inline (inside the class declaration), so the notation that contains the call to the base class constructor appears there. If the constructor were defined outside the class, the notation would appear in the function header. For example, the `Box` class could appear as follows:

```
class Box : public Rectangle
{
protected:
    double height;
    double volume;
public:
    // Default constructor
    Box() : Rectangle()
        { height = 0.0; volume = 0.0; }

    // Constructor #2
    Box(double, double, double);

    double getHeight() const
        { return height; }

    double getVolume() const
        { return volume; }
};

// Box class constructor #2
Box::Box(double w, double len, double h) : Rectangle(w, len)
{
    height = h;
    volume = getArea() * h;
}
```

The base class constructor is always executed before the derived class constructor. When the `Rectangle` constructor finishes, the `Box` constructor is then executed.

Any literal value or variable that is in scope may be used as an argument to the derived class constructor. Usually, one or more of the arguments passed to the derived class constructor are, in turn, passed to the base class constructor. The values that may be used as base class constructor arguments are as follows:

- Derived class constructor parameters
- Literal values
- Global variables that are accessible to the file containing the derived class constructor definition
- Expressions involving any of these items

**Program 15-5**  shows the `Rectangle` and `Box` classes in use.



## Program 15-5

```
1 // This program demonstrates passing arguments
to a base
2 // class constructor.
3 #include <iostream>
4 #include "Box.h"
5 using namespace std;
6
7 int main()
8 {
9     double boxWidth; // To hold the box's
width
10    double boxLength; // To hold the box's
length
11    double boxHeight; // To hold the box's
height
12
13    // Get the width, length, and height from
the user.
14    cout << "Enter the dimensions of a box:\n";
15    cout << "Width: ";
16    cin >> boxWidth;
17    cout << "Length: ";
18    cin >> boxLength;
```

```
19     cout << "Height: ";
20     cin >> boxHeight;
21
22     // Define a Box object.
23     Box myBox(boxWidth, boxLength, boxHeight);
24
25     // Display the Box object's properties.
26     cout << "Here are the box's properties:\n";
27     cout << "Width: " << myBox.getWidth() <<
endl;
28     cout << "Length: " << myBox.getLength() <<
endl;
29     cout << "Height: " << myBox.getHeight() <<
endl;
30     cout << "Base area: " << myBox.getArea() <<
endl;
31     cout << "Volume: " << myBox.getVolume() <<
endl;
32     return 0;
33 }
```

**Program Output with Example Input Shown in Bold**

```
Enter the dimensions of a box:
```

```
Width: 10 Enter
```

```
Length: 15 Enter
```

```
Height: 12 Enter
```

```
Here are the box's properties:
```

```
Width: 10
```

```
Length: 15
```

```
Height: 12
```

```
Base area: 150
```

```
Volume: 1800
```



**Note:**

If the base class has no default constructor, then the derived class must have a constructor that calls one of the base class constructors.



In the

## Spotlight:

### The `Automobile`, `Car`, `Truck`, and `SUV` Classes

Suppose we are developing a program that a car dealership can use to manage its inventory of used cars. The dealership's inventory includes three types of automobiles: cars, pickup trucks, and sport-utility vehicles (SUVs). Regardless of the type, the dealership keeps the following data about each automobile:

- Make
- Year model
- Mileage
- Price

Each type of vehicle that is kept in inventory has these general characteristics, plus its own specialized characteristics. For cars, the dealership keeps the following additional data:

- Number of doors (2 or 4)

For pickup trucks, the dealership keeps the following additional data:

- Drive type (two-wheel drive or four-wheel drive)

And, for SUVs, the dealership keeps the following additional data:

- Passenger capacity

In designing this program, one approach would be to write the following three classes:

- A `Car` class with attributes for the make, year model, mileage, price, and number of doors.
- A `Truck` class with attributes for the make, year model, mileage, price, and drive type.
- An `SUV` class with attributes for the make, year model, mileage, price, and passenger capacity.

This would be an inefficient approach, however, because all three classes have a large number of common data attributes. As a result, the classes would contain a lot of duplicated code. In addition, if we discover later we need to add more common attributes, we would have to modify all three classes.

A better approach would be to write an `Automobile` base class to hold all the general data about an automobile, then write derived classes for each specific type of automobile. The following code shows the `Automobile` class. (This file can be found in the Student Source Code Folder **Chapter 15** `\Automobile`.)

## Contents of `Automobile.h`

```
1  #ifndef AUTOMOBILE_H
2  #define AUTOMOBILE_H
3  #include <string>
4  using namespace std;
5
6  // The Automobile class holds general
data
7  // about an automobile in inventory.
8  class Automobile
9  {
10 private:
11     string make; // The auto's make
12     int model; // The auto's year
model
13     int mileage; // The auto's mileage
14     double price; // The auto's price
15
16 public:
17     // Default constructor
18     Automobile()
19     { make = "";
20       model = 0;
```

```
21     mileage = 0;
22     price = 0.0; }
23
24     // Constructor
25     Automobile(string autoMake, int
autoModel,
26                 int autoMileage, double
autoPrice)
27     {   make = autoMake;
28         model = autoModel;
29         mileage = autoMileage;
30         price = autoPrice; }
31
32     // Accessors
33     string getMake() const
34     { return make; }
35
36     int getModel() const
37     { return model; }
38
39     int getMileage() const
40     { return mileage; }
41
42     double getPrice() const
43     { return price; }
44 };
45 #endif
```

Notice the class has a default constructor in lines 18 and 22, and a constructor that accepts arguments for all of the class's attributes in lines 25 through 30. The `Automobile` class is a complete class from which we can create objects. If we wish, we can write a program that creates instances of the `Automobile` class. However, the `Automobile` class holds only general data about an automobile. It does not hold any of the specific pieces of data that the dealership wants to keep about cars, pickup trucks, and SUVs. To hold data about those specific types of automobiles, we will write derived classes that inherit from the `Automobile` class. The following shows the code for the `Car` class. (This file is available in the Student Source Code Folder [Chapter 15](#) \Automobile.)



## Contents of Car.h

```
1  #ifndef CAR_H
2  #define CAR_H
3  #include "Automobile.h"
4  #include <string>
5  using namespace std;
6
7  // The Car class represents a car.
8  class Car : public Automobile
9  {
10 private:
11     int doors;
12
13 public:
14     // Default constructor
15     Car() : Automobile()
16     { doors = 0;}
17
18     // Constructor #2
19     Car(string carMake, int carModel,
20         int carMileage,
21         double carPrice, int carDoors) :
22         Automobile(carMake, carModel,
```

```
carMileage, carPrice)
22     { doors = carDoors; }
23
24     // Accessor for doors attribute
25     int getDoors()
26     {return doors;}
27 };
28 #endif
```

The `Car` class defines a `doors` attribute in line 11 to hold the car's number of doors. The class has a default constructor in lines 15 and 16 that sets the `doors` attribute to 0. Notice in line 15 the default constructor calls the `Automobile` class's default constructor, which initializes all of the inherited attributes to their default values.

The `Car` class also has an overloaded constructor, in lines 19 through 22, that accepts arguments for the car's make, model, mileage, price, and number of doors. Line 21 calls the `Automobile` class's constructor, passing the make, model, mileage, and price as arguments. Line 22 sets the value of the `doors` attribute.

Now let's look at the `Truck` class, which also inherits from the `Automobile` class. (This file is available in the Student Source Code Folder [Chapter 15](#) \Automobile.)


## Contents of Truck.h

```
1  #ifndef TRUCK_H
2  #define TRUCK_H
3  #include "Automobile.h"
4  #include <string>
5  using namespace std;
6
7  // The Truck class represents a truck.
8  class Truck : public Automobile
9  {
10 private:
11     string driveType;
12
13 public:
14     // Default constructor
15     Truck() : Automobile()
16     { driveType = ""; }
17
18     // Constructor #2
19     Truck(string truckMake, int
20 truckModel, int truckMileage,
21 double truckPrice, string
22 truckDriveType) :
```

```
21     Automobile(truckMake,
truckModel, truckMileage, truckPrice)
22     { driveType = truckDriveType; }
23
24     // Accessor for driveType attribute
25     string getDriveType()
26     { return driveType; }
27 };
28 #endif
```

The `Truck` class defines a `driveType` attribute in line 11 to hold a string describing the truck's drive type. The class has a default constructor in lines 15 and 16 that sets the `driveType` attribute to an empty string. Notice in line 15 the default constructor calls the `Automobile` class's default constructor, which initializes all of the inherited attributes to their default values.

The `Truck` class also has an overloaded constructor, in lines 19 through 22, that accepts arguments for the truck's make, model, mileage, price, and drive type. Line 21 calls the `Automobile` class's constructor, passing the make, model, mileage, and price as arguments. Line 22 sets the value of the `driveType` attribute.

Now let's look at the `SUV` class, which also inherits from the `Automobile` class. (This file can be found in the Student Source Code Folder **Chapter 15** Automobile.)

## Contents of SUV.h

```
1  #ifndef SUV_H
2  #define SUV_H
3  #include "Automobile.h"
4  #include <string>
5  using namespace std;
6
7  // The SUV class represents a SUV.
8  class SUV : public Automobile
9  {
10 private:
11     int passengers;
12
13 public:
14     // Default constructor
15     SUV() : Automobile()
16     { passengers = 0; }
17
18     // Constructor #2
19     SUV(string SUVMake, int SUVModel,
20         int SUVMileage,
21         double SUVPrice, int
22         SUVPassengers) :
```



```

21     Automobile(SUVMake, SUVModel,
SUVMileage, SUVPrice)
22     { passengers = SUVPassengers; }
23
24     // Accessor for passengers
attribute
25     int getPassengers()
26     { return passengers; }
27 };
28 #endif

```

The `SUV` class defines a `passengers` attribute in line 11 to hold the number of passengers that the vehicle can accommodate. The class has a default constructor in lines 15 and 16 that sets the `passengers` attribute to 0. Notice in line 15 the default constructor calls the `Automobile` class's default constructor, which initializes all of the inherited attributes to their default values.

The `SUV` class also has an overloaded constructor, in lines 19 through 22, that accepts arguments for the SUV's make, model, mileage, price, and number of passengers. Line 21 calls the `Automobile` class's constructor, passing the make, model, mileage, and price as arguments. Line 22 sets the value of the `passengers` attribute.

**Program 15-6**  demonstrates each of the derived classes. It creates a `Car` object, a `Truck` object, and an `SUV` object. (This file can be found in the Student Source Code Folder **Chapter 15**  \Automobile.)



## Program 15-6

```
1 // This program demonstrates the Car,  
Truck, and SUV  
2 // classes that are derived from the  
Automobile class.  
3 #include <iostream>  
4 #include <iomanip>  
5 #include "Car.h"  
6 #include "Truck.h"  
7 #include "SUV.h"  
8 using namespace std;  
9  
10 int main()  
11 {  
12     // Create a Car object for a used  
2007 BMW with  
13     // 50,000 miles, priced at $15,000,  
with 4 doors.  
14     Car car("BMW", 2007, 50000,  
15000.0, 4);  
15  
16     // Create a Truck object for a used  
2006 Toyota
```

```
17 // pickup with 40,000 miles, priced
at $12,000,
18 // with 4-wheel drive.
19 Truck truck("Toyota", 2006, 40000,
12000.0, "4WD");
20
21 // Create an SUV object for a used
2005 Volvo
22 // with 30,000 miles, priced at
$18,000, with
23 // 5 passenger capacity.
24 SUV suv("Volvo", 2005, 30000,
18000.0, 5);
25
26 // Display the automobiles we have
in inventory.
27 cout << fixed << showpoint <<
setprecision(2);
28 cout << "We have the following car
in inventory:\n"
29 << car.getModel() << " " <<
car.getMake()
30 << " with " << car.getDoors()
<< " doors and "
31 << car.getMileage() << "
miles.\nPrice: $"
32 << car.getPrice() << endl <<
```

```
endl;
33
34     cout << "We have the following
truck in inventory:\n"
35         << truck.getModel() << " " <<
truck.getMake()
36         << " with " <<
truck.getDriveType()
37         << " drive type and " <<
truck.getMileage()
38         << " miles.\nPrice: $" <<
truck.getPrice()
39         << endl << endl;
40
41     cout << "We have the following SUV
in inventory:\n"
42         << suv.getModel() << " " <<
suv.getMake()
43         << " with " <<
suv.getMileage() << " miles and "
44         << suv.getPassengers() << "
passenger capacity.\n"
45         << "Price: $" <<
suv.getPrice() << endl;
46
47     return 0;
48 }
```

## Program Output

```
We have the following car in
inventory:
2007 BMW with 4 doors and 50000 miles.
Price: $15000.00
```

```
We have the following truck in
inventory:
2006 Toyota with 4WD drive type and
40000 miles.
Price: $12000.00
```

```
We have the following SUV in
inventory:
2005 Volvo with 30000 miles and 5
passenger capacity.
Price: $18000.00
```

# Constructor Inheritance

**11** C++ 11 provides a way for a derived class to inherit some of the base class's constructors. The constructors that cannot be inherited are the default constructor, the copy constructor, and the move constructor. Any other constructors in the base class can be inherited.

Constructor inheritance can be helpful in situations where the derived class's constructors simply invoke the base class's constructors. For example, look at the following classes:

```

class MyBase
{
private:
    int ival;
    double dval;
public:
    MyBase(int i)
    { ival = i; }
    MyBase(double d)
    { dval = d; }
};

class MyDerived : MyBase
{
public:
    MyDerived(int i) : MyBase(i)
    {}
    MyDerived(double d) : MyBase(d)
    {}
};

```

In this code, the `MyDerived(int i)` constructor simply calls the `MyBase(int i)` constructor, and the `MyDerived(double d)` constructor simply calls the `MyBase(double d)` constructor. In C++ 11, we rewrite the `MyDerived` class as follows, and achieve the same result:

```
class MyDerived : MyBase
{
    using MyBase::MyBase;
};
```

The `using` statement causes the `MyDerived` class to inherit the `MyBase` class's constructors. As a result, we can invoke the `MyBase` class's constructors when we instantiate the `MyDerived` class.

```
MyDerived d1(22); // Calls the MyBase(int i) constructor
MyDerived d2(3.14); // Calls the MyBase(double d) constructor
```

You can write the using statement anywhere in the derived class. The general format of the using statement in a derived class is

```
using BaseClassName::BaseClassName;
```

A derived class can have its own constructors, and inherit constructors from the base class. Here is an example:

```
class Derived : Base
{
private:
    string str;
public:
    using Base::Base;
    Derived(string s) : Base(0)
    { str = s; }
};
```

Keep in mind, however, if a derived class constructor has the same parameter list as a base class constructor, the base class constructor will not be inherited.





## 15.7 What will the following program display?

```
#include <iostream>

using namespace std;

class Sky
{
public:
    Sky()
        { cout << "Entering the sky.\n"; }
    ~Sky()
        { cout << "Leaving the sky.\n"; }
};

class Ground : public Sky
{
public:
    Ground()
        { cout << "Entering the Ground.\n"; }
    ~Ground()
        { cout << "Leaving the Ground.\n"; }
};

int main()
{
    Ground object;
    return 0;
}
```

15.8 What will the following program display?

```
#include <iostream>

using namespace std;

class Sky
{
public:
    Sky()
        { cout << "Entering the sky.\n"; }
    Sky(string color)
        { cout << "The sky is " << color << endl; }
    ~Sky()
        { cout << "Leaving the sky.\n"; }
};

class Ground : public Sky
{
public:
    Ground()
        { cout << "Entering the Ground.\n"; }
    Ground(string c1, string c2) : Sky(c1)
        { cout << "The ground is " << c2 << endl; }
    ~Ground()
        { cout << "Leaving the Ground.\n"; }
};

int main()
{
    Ground object;
```

```
return 0;
```

```
}
```

# 15.4 Redefining Base Class Functions

## **Concept:**

A base class member function may be redefined in a derived class.



## **Redefining a Base Class Function in a Derived Class**

Inheritance is commonly used to extend a class, or to give it additional capabilities. Sometimes it may be helpful to overload a base class function with a function of the same name in the derived

class. For example, recall the `GradedActivity` class that was presented earlier in this chapter:

```
class GradedActivity
{
protected:
    char letter;           // To hold the letter grade
    double score;         // To hold the numeric score
    void determineGrade(); // Determines the letter grade
public:
    // Default constructor
    GradedActivity()
    { letter = ' '; score = 0.0; }

    // Mutator function
    void setScore(double s)
    { score = s;
      determineGrade(); }

    // Accessor functions
    double getScore() const
    { return score; }

    char getLetterGrade() const
    { return letter; }
};
```

This class holds a numeric score and determines a letter grade based on that score. The `setScore` member function stores a value in score, then calls the `determineGrade` member function to determine the letter grade.

Suppose a teacher wants to “curve” a numeric score before the letter grade is determined. For example, Dr. Harrison determines that in order to curve the grades in her class, she must multiply each student’s score by a certain percentage. This gives an adjusted score, which is used to determine the letter grade.

The following `CurvedActivity` class is derived from the `GradedActivity` class. It multiplies the numeric score by a percentage, and passes that value as an argument to the base class’s `setScore` function. (This file can be found in the Student Source Code Folder [Chapter 15](#) \CurvedActivity.)

## Contents of `CurvedActivity.h`

```
1  #ifndef CURVEDACTIVITY_H
2  #define CURVEDACTIVITY_H
3  #include "GradedActivity.h"
4
5  class CurvedActivity : public GradedActivity
6  {
7  protected:
8      double rawScore;    // Unadjusted score
9      double percentage;  // Curve percentage
10 public:
11     // Default constructor
12     CurvedActivity() : GradedActivity()
13     { rawScore = 0.0; percentage = 0.0; }
14
15     // Mutator functions
16     void setScore(double s)
17     { rawScore = s;
18       GradedActivity::setScore(rawScore *
percentage); }
19
20     void setPercentage(double c)
21     { percentage = c; }
22
```



```
23     // Accessor functions
24     double getPercentage() const
25     { return percentage; }
26
27     double getRawScore() const
28     { return rawScore; }
29 };
30 #endif
```

This `CurvedActivity` class has the following member variables:

It also has the following member functions:



### Note:

Although we are not using the `CurvedActivity` class as a base class, it still has a protected member section. This is because we might want to use the `CurvedActivity` class itself as a base class, as you will see in the next section.

Notice the `CurvedActivity` class has a `setScore` member function. This function has the same name as one of the base class member functions. When a derived class's member function has the same name as a base class member function, it is said the derived class function *redefines* the base class function. When an object of the derived class calls the function, it calls the derived class's version of the function.

There is a distinction between redefining a function and overloading a function. An overloaded function is one with the same name as one or more other functions, but with a different parameter list. The compiler uses the arguments passed to the function to tell which version to call. Overloading can take place with regular functions that are not members of a class. Overloading can also take place inside a class when two or more member functions *of the same class* have the same name. These member functions must have different parameter lists for the compiler to tell them apart in function calls.

Redefining happens when a derived class has a function with the same name as a base class function. The parameter lists of the two functions can be the same because the derived class function is always called by objects of the derived class type.

Let's continue our look at the `CurvedActivity` class. Here is the `setScore` member function:



```
void setScore(double s)
{
    rawScore = s;
    GradedActivity::setScore(rawScore * percentage);
}
```

This function accepts an argument that should be the student's unadjusted numeric score, into the parameter `s`. This value is stored in the `rawScore` variable. Then, the following statement is executed:

```
GradedActivity::setScore(rawScore * percentage);
```

This statement calls the base class's version of the `setScore` function with the expression `rawScore * percentage` passed as an argument. Notice the name of the base class and the scope resolution operator precede the name of the function. This specifies that the base class's version of the `setScore` function is being called. A derived class function may call a base class function of the same name using this notation, which takes this form:

```
BaseClassName::functionName (ArgumentList);
```

**Program 15-7**  shows the `GradedActivity` and `CurvedActivity` classes used in a complete program. (This file is available in the Student Source Code Folder **Chapter 15**  \CurvedActivity.)


## Program 15-7

```
1 // This program demonstrates a class that
redefines
2 // a base class function.
3 #include <iostream>
4 #include <iomanip>
5 #include "CurvedActivity.h"
6 using namespace std;
7
8 int main()
9 {
10     double numericScore; // To hold the
numeric score
11     double percentage; // To hold curve
percentage
12
13     // Define a CurvedActivity object.
14     CurvedActivity exam;
15
16     // Get the unadjusted score.
17     cout << "Enter the student's raw numeric
score: ";
18     cin >> numericScore;
19
```

```
20 // Get the curve percentage.
21 cout << "Enter the curve percentage for
this student: ";
22 cin >> percentage;
23
24 // Send the values to the exam object.
25 exam.setPercentage(percentage);
26 exam.setScore(numericScore);
27
28 // Display the grade data.
29 cout << fixed << setprecision(2);
30 cout << "The raw score is "
31 << exam.getRawScore() << endl;
32 cout << "The curved score is "
33 << exam.getScore() << endl;
34 cout << "The curved grade is "
35 << exam.getLetterGrade() << endl;
36
37 return 0;
38 }
```

**Program Output with Example Input Shown in Bold**

```
Enter the student's raw numeric score: 87
Enter
Enter the curve percentage for this student:
1.06 Enter
The raw score is 87.00
The curved score is 92.22
The curved grade is A
```

It is important to note even though a derived class may redefine a function in the base class, objects that are defined of the base class type still call the base class version of the function. This is demonstrated in [Program 15-8](#) .


## Program 15-8

```
1 // This program demonstrates that when a
derived class function
2 // overrides a class function, objects of the
base class
3 // still call the base class version of the
function.
4 #include <iostream>
5 using namespace std;
6
7 class BaseClass
8 {
9 public:
10     void showMessage()
11         { cout << "This is the Base class.\n";}
12 };
13
14 class DerivedClass : public BaseClass
15 {
16 public:
17     void showMessage()
18         { cout << "This is the Derived
class.\n"; }
19 };
```

```
20
21 int main()
22 {
23     BaseClass b;
24     DerivedClass d;
25
26     b.showMessage();
27     d.showMessage();
28
29     return 0;
30 }
```

## Program Output

```
This is the Base class.
This is the Derived class.
```

In **Program 15-8** , a class named `BaseClass` is declared with a member function named `showMessage`. A class named `DerivedClass` is then declared, also with a `showMessage` member function. As their names imply, `DerivedClass` is derived from `BaseClass`. Two objects, `b` and `d`, are defined in function `main`. The object `b` is a `BaseClass` object, and `d` is a `DerivedClass`



object. When `b` is used to call the `showMessage` function, it is the `BaseClass` version that is executed. Likewise, when `d` is used to call `showMessage`, the `DerivedClass` version is used.

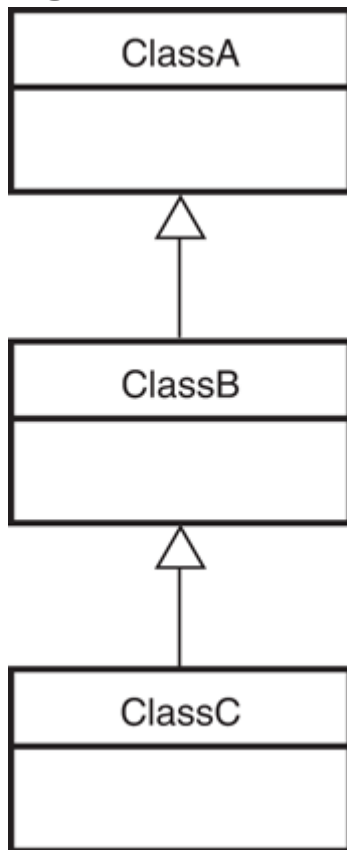
## 15.5 Class Hierarchies

### **Concept:**

A base class can also be derived from another class.

Sometimes it is desirable to establish a hierarchy of classes in which one class inherits from a second class, which in turn inherits from a third class, as illustrated by [Figure 15-4](#). In some cases, the inheritance of classes goes on for many layers.

**Figure 15-4 Class hierarchy**



In [Figure 15-4](#), `ClassC` inherits `ClassB`'s members, including the ones that `ClassB` inherited from `ClassA`. Let's look at an example of such a chain of inheritance. Consider the following `PassFailActivity` class, which inherits from the `GradedActivity` class. The class is intended to determine a letter grade of 'P' for passing, or 'F' for failing. (This file can be found in the Student Source Code Folder [Chapter 15](#)\PassFailActivity.)

## Contents of `PassFailActivity.h`

```
1  #ifndef PASSFAILACTIVITY_H
2  #define PASSFAILACTIVITY_H
3  #include "GradedActivity.h"
4
5  class PassFailActivity : public GradedActivity
6  {
7  protected:
8      double minPassingScore; // Minimum
passing score.
9  public:
10     // Default constructor
11     PassFailActivity() : GradedActivity()
12     { minPassingScore = 0.0; }
13
14     // Constructor
15     PassFailActivity(double mps) :
GradedActivity()
16     { minPassingScore = mps; }
17
18     // Mutator
19     void setMinPassingScore(double mps)
20     { minPassingScore = mps; }
21
```

```
22     // Accessors
23     double getMinPassingScore() const
24     { return minPassingScore; }
25
26     char getLetterGrade() const;
27 };
28 #endif
```

The `PassFailActivity` class has a private member variable named `minPassingScore`. This variable holds the minimum passing score for an activity. The default constructor, in lines 11 and 12, sets `minPassingScore` to 0.0. An overloaded constructor in lines 15 and 16 accepts a `double` argument that is the minimum passing grade for the activity. This value is stored in the `minPassingScore` variable. The `getLetterGrade` member function is defined in the following `PassFailActivity.cpp` file. (This file can be found in the Student Source Code Folder **Chapter 15** \PassFailActivity.)

## Contents of `PassFailActivity.cpp`

```
1  #include "PassFailActivity.h"
2
3
4  //*****
5  // Member function
6  PassFailActivity::getLetterGrade *
7  // This function returns 'P' if the score is
8  passing, *
9  // otherwise it returns 'F'.
10 *
11
12 //*****
13
14 char PassFailActivity::getLetterGrade() const
15 {
16     char letterGrade;
17
18     if (score >= minPassingScore)
19         letterGrade = 'P';
20     else
21         letterGrade = 'F';
```

```
17
18     return letterGrade;
19 }
```

This `getLetterGrade` member function redefines the `getLetterGrade` member function of `GradedActivity` class. This version of the function returns a grade of `'P'` if the numeric score is greater than or equal to `minPassingScore`. Otherwise, the function returns a grade of `'F'`.

The `PassFailActivity` class represents the general characteristics of a student's pass-or-fail activity. There might be numerous types of pass-or-fail activities, however. Suppose we need a more specialized class, such as one that determines a student's grade for a pass-or-fail exam. The following `PassFailExam` class is an example. This class is derived from the `PassFailActivity` class. It inherits all of the members of `PassFailActivity`, including the ones that `PassFailActivity` inherits from `GradedActivity`. The `PassFailExam` class calculates the number of points that each question on the exam is worth, as well as the student's numeric score. (These files are available in the Student Source Code Folder [Chapter 15](#) \PassFailActivity.)

## Contents of `PassFailExam.h`

```
1  #ifndef PASSFAILEXAM_H
2  #define PASSFAILEXAM_H
3  #include "PassFailActivity.h"
4
5  class PassFailExam : public PassFailActivity
6  {
7  private:
8      int numQuestions;    // Number of
questions
9      double pointsEach;  // Points for each
question
10     int numMissed;      // Number of
questions missed
11 public:
12     // Default constructor
13     PassFailExam() : PassFailActivity()
14     { numQuestions = 0;
15       pointsEach = 0.0;
16       numMissed = 0; }
17
18     // Constructor
19     PassFailExam(int questions, int missed,
double mps) :
```



```
20     PassFailActivity(mps)
21     { set(questions, missed); }
22
23     // Mutator function
24     void set(int, int); // Defined in
PassFailExam.cpp
25
26     // Accessor functions
27     double getNumQuestions() const
28     { return numQuestions; }
29
30     double getPointsEach() const
31     { return pointsEach; }
32
33     int getNumMissed() const
34     { return numMissed; }
35 };
36 #endif
```


## Contents of `PassFailExam.cpp`

```
1  #include "PassFailExam.h"
2
3
4  //*****
5  // set function
6  *
7  // The parameters are the number of questions
8  and the *
9  // number of questions missed.
10 *
11
12 //*****
13 *
14
15 //*****
16 *
17
18 //*****
19 *
20
21 //*****
22 *
23
24 //*****
25 *
26
27 //*****
28 *
29
30 //*****
31 *
32
33 //*****
34 *
35
36 //*****
37 *
38
39 //*****
40 *
41
42 //*****
43 *
44
45 //*****
46 *
47
48 //*****
49 *
50
51 //*****
52 *
53
54 //*****
55 *
56
57 //*****
58 *
59
60 //*****
61 *
62
63 //*****
64 *
65
66 //*****
67 *
68
69 //*****
70 *
71
72 //*****
73 *
74
75 //*****
76 *
77
78 //*****
79 *
80
81 //*****
82 *
83
84 //*****
85 *
86
87 //*****
88 *
89
90 //*****
91 *
92
93 //*****
94 *
95
96 //*****
97 *
98
99 //*****
100 *
```

```

14     numQuestions = questions;
15     numMissed = missed;
16
17     // Calculate the points for each question.
18     pointsEach = 100.0 / numQuestions;
19
20     // Calculate the numeric score for this
exam.
21     numericScore = 100.0 - (missed *
pointsEach);
22
23     // Call the inherited setScore function to
set
24     // the numeric score.
25     setScore(numericScore);
26 }

```

The `PassFailExam` class inherits all of the `PassFailActivity` class's members, including the ones that `PassFailActivity` inherited from `GradedActivity`. Because the `public` base class access specification is used, all of the protected members of `PassFailActivity` become protected members of `PassFailExam`, and all of the `public` members of `PassFailActivity` become `public` members of `PassFailExam`. [Table 15-2](#)  lists all of the

member variables of the `PassFailExam` class, and **Table 15-3** lists all the member functions. These include the members that were inherited from the base classes.

#### **Table 15-2 Member Variables of the `PassFailExam` Class**

#### **Table 15-3 Member Functions of the `PassFailExam` Class**

**Program 15-9** demonstrates the `PassFailExam` class. This file can be found in the student source code folder **Chapter 15**\PassFailActivity.

## Program 15-9

```
1 // This program demonstrates the PassFailExam
class.
2 #include <iostream>
3 #include <iomanip>
4 #include "PassFailExam.h"
5 using namespace std;
6
7 int main()
8 {
9     int questions;           // Number of
questions
10    int missed;              // Number of
questions missed
11    double minPassing;      // The minimum
passing score
12
13    // Get the number of questions on the
exam.
14    cout << "How many questions are on the
exam? ";
15    cin >> questions;
16
17    // Get the number of questions the student
```


```
missed.  
  
18     cout << "How many questions did the  
student miss? ";  
  
19     cin >> missed;  
  
20  
  
21     // Get the minimum passing score.  
  
22     cout << "Enter the minimum passing score  
for this test: ";  
  
23     cin >> minPassing;  
  
24  
  
25     // Define a PassFailExam object.  
  
26     PassFailExam exam(questions, missed,  
minPassing);  
  
27  
  
28     // Display the test results.  
  
29     cout << fixed << setprecision(1);  
  
30     cout << "\nEach question counts "  
31         << exam.getPointsEach() << "  
points.\n";  
  
32     cout << "The minimum passing score is "  
33         << exam.getMinPassingScore() << endl;  
  
34     cout << "The student's exam score is "  
35         << exam.getScore() << endl;  
  
36     cout << "The student's grade is "  
37         << exam.getLetterGrade() << endl;  
  
38     return 0;  
  
39 }
```

## Program Output with Example Input Shown in Bold

```
How many questions are on the exam? 100
Enter
How many questions did the student miss? 25
Enter
Enter the minimum passing score for this
test: 60 Enter

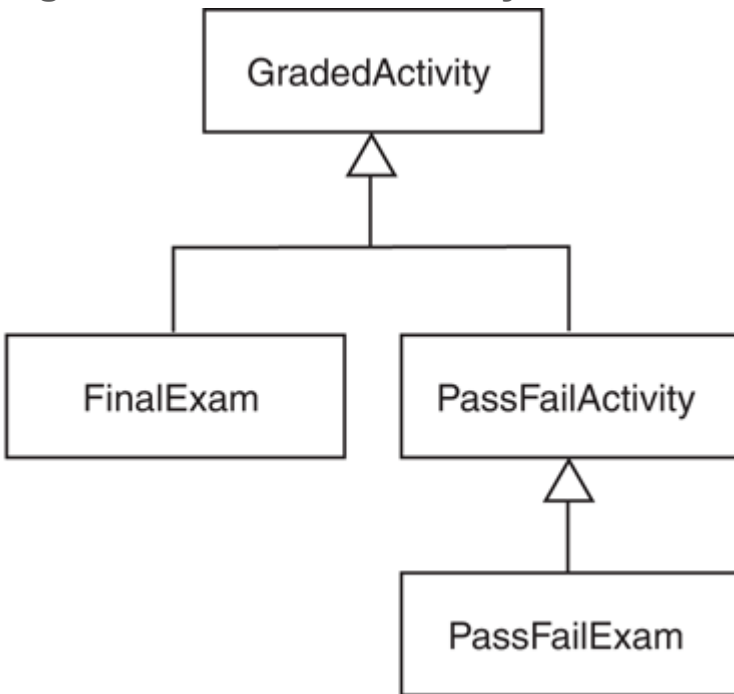
Each question counts 1.0 points.
The minimum passing score is 60.0
The student's exam score is 75.0
The student's grade is P
```

This program uses the `PassFailExam` object to call the `getLetterGrade` member function in line 37. Recall that the `PassFailActivity` class redefines the `getLetterGrade` function to report only grades of 'P' or 'F'. Because the `PassFailExam` class is derived from the `PassFailActivity` class, it inherits the redefined `getLetterGrade` function.

Software designers often use class hierarchy diagrams. Like a family tree, a class hierarchy diagram shows the inheritance relationships between classes. [Figure 15-5](#)  shows a class hierarchy for the

GradedActivity, FinalExam, PassFailActivity, and PassFailExam classes. The more general classes are toward the top of the tree, and the more specialized classes are toward the bottom.

**Figure 15-5 Class hierarchy**





# 15.6 Polymorphism and Virtual Member Functions

## Concept:

Polymorphism allows an object reference variable or an object pointer to reference objects of different types and to call the correct member functions, depending upon the type of object being referenced.



## Polymorphism

Look at the following code for a function named `displayGrade`:

```
void displayGrade(const GradedActivity &activity)
{
    cout << setprecision(1) << fixed;
    cout << "The activity's numeric score is "
        << activity.getScore() << endl;
    cout << "The activity's letter grade is "
        << activity.getLetterGrade() << endl;
}
```

This function uses a `const GradedActivity` reference variable as its parameter. When a `GradedActivity` object is passed as an argument to this function, the function calls the object's `getScore` and `getLetterGrade` member functions to display the numeric score and letter grade. The following code shows how we might call the function:

```
GradedActivity test(88.0); // The score is 88
displayGrade(test);      // Pass test to displayGrade
```

This code will produce the following output:

```
The activity's numeric score is 88.0
The activity's letter grade is B
```



Recall the `GradedActivity` class is also the base class for the `FinalExam` class. Because of the “is-a” relationship between a base class and a derived class, an object of the `FinalExam` class is not just a `FinalExam` object. It is also a `GradedActivity` object. (A final exam *is a* graded activity.) Because of this relationship, we can also pass a `FinalExam` object to the `displayGrade` function. For example, look at the following code:

```
// There are 100 questions. The student missed 25.  
FinalExam test2(100, 25);  
displayGrade(test2);
```

This code will produce the following output:

```
The activity's numeric score is 75.0  
The activity's letter grade is C
```

Because the parameter in the `displayGrade` function is a `GradedActivity` reference variable, it can reference any object that is derived from `GradedActivity`. A problem can occur with this type of code, however, when redefined member functions are involved. For example, recall that the `PassFailActivity` class is derived from the `GradedActivity` class. The `PassFailActivity` class redefines the `getLetterGrade` function. Although we can pass a

`PassFailActivity` object as an argument to the `displayGrade` function, we will not get the results we wish. This is demonstrated in **Program 15-10** . (This file is available in the Student Source Code Folder **Chapter 15**  \PassFailActivity.)

## Program 15-10

```
1  #include <iostream>
2  #include <iomanip>
3  #include "PassFailActivity.h"
4  using namespace std;
5
6  // Function prototype
7  void displayGrade(const GradedActivity &);
8
9  int main()
10 {
11     // Create a PassFailActivity object.
12     // Minimum passing
13     // score is 70.
14     PassFailActivity test(70);
15
16     // Set the score to 72.
17     test.setScore(72);
18
19     // Display the object's grade data. The
20     // letter grade
21     // should be 'P'. What will be displayed?
22     displayGrade(test);
23
24     return 0;
```

```


22 }
23
24
//*****
*****
25 // The displayGrade function displays a
GradedActivity object's *
26 // numeric score and letter grade.
*
27
//*****
*****
28
29 void displayGrade(const GradedActivity
&activity)
30 {
31     cout << setprecision(1) << fixed;
32     cout << "The activity's numeric score is "
33         << activity.getScore() << endl;
34     cout << "The activity's letter grade is "
35         << activity.getLetterGrade() << endl;
36 }

```

## Program Output

```
The activity's numeric score is 72.0
The activity's letter grade is C
```

As you can see from the example output, the `getLetterGrade` member function returned 'C' instead of 'P'. This is because the `GradedActivity` class's `getLetterGrade` function was executed instead of the `PassFailActivity` class's version of the function.

This behavior happens because of the way C++ matches function calls with the correct function. This process is known as *binding*. In **Program 15-10** , C++ decides at compile time which version of the `getLetterGrade` function to execute when it encounters the call to the function in line 35. Even though we passed a `PassFailActivity` object to the `displayGrade` function, the `activity` parameter in the `displayGrade` function is a `GradedActivity` reference variable. Because it is of the `GradedActivity` type, the compiler binds the function call in line 35 with the `GradedActivity` class's `getLetterGrade` function. When the program executes, it has already been determined by the compiler that the `GradedActivity` class's `getLetterGrade` function will be called. The process of matching a function call with a function at compile time is called *static binding*.

To remedy this, the `getLetterGrade` function can be made *virtual*. A *virtual function* is a member function that is dynamically bound to function calls. In *dynamic binding*, C++ determines which function to call at runtime, depending on the type of the object responsible for the call. If a `GradedActivity` object is responsible for the call, C++ will execute the `GradedActivity::getLetterGrade` function. If a `PassFailActivity` object is responsible for the call, C++ will execute the `PassFailActivity::getLetterGrade` function.

Virtual functions are declared by placing the key word `virtual` before the return type in the base class's function declaration, such as

```
virtual char getLetterGrade() const;
```


This declaration tells the compiler to expect `getLetterGrade` to be redefined in a derived class. The compiler does not bind calls to the function with the actual function. Instead, it allows the program to bind calls, at runtime, to the version of the function that belongs to the same class as the object responsible for the call.





## Note:

You place the `virtual` key word only in the function's declaration or prototype. If the function is defined outside the class, you do not place the `virtual` key word in the function header.

The following code shows an updated version of the `GradedActivity` class, with the `getLetterGrade` function declared `virtual`. This file can be found in the Student Source Code Folder **Chapter 15**  `GradedActivity Version 3`. The `GradedActivity.cpp` file has not changed, so it is not shown again.

## Contents of GradedActivity.h (Version 3)

```
1  #ifndef GRADEDACTIVITY_H
2  #define GRADEDACTIVITY_H
3
4  // GradedActivity class declaration
5
6  class GradedActivity
7  {
8  protected:
9      double score; // To hold the numeric
score
10 public:
11     // Default constructor
12     GradedActivity()
13         { score = 0.0; }
14
15     // Constructor
16     GradedActivity(double s)
17         { score = s; }
18
19     // Mutator function
20     void setScore(double s)
21         { score = s; }
```

```
22
23     // Accessor functions
24     double getScore() const
25     { return score; }
26
27     virtual char getLetterGrade() const;
28 };
29 #endif
```

The only change we have made to this class is to declare `getLetterGrade` as `virtual` in line 27. This tells the compiler not to bind calls to `getLetterGrade` with the function at compile time. Instead, calls to the function will be bound dynamically to the function at runtime.

When a member function is declared `virtual` in a base class, any redefined versions of the function that appear in derived classes automatically become `virtual`. So, it is not necessary to declare the `getLetterGrade` function in the `PassFailActivity` class as `virtual`. It is still a good idea to declare the function `virtual` in the `PassFailActivity` class for documentation purposes. A new version of the `PassFailActivity` class is shown here. This file can be found in the Student Source Code Folder [Chapter 15](#) \GradedActivity

Version 3. The `PassFailActivity.cpp` file has not changed, so it is not shown again.

## Contents of `PassFailActivity.h`

```
1  #ifndef PASSFAILACTIVITY_H
2  #define PASSFAILACTIVITY_H
3  #include "GradedActivity.h"
4
5  class PassFailActivity : public GradedActivity
6  {
7  protected:
8      double minPassingScore; // Minimum
9  passing score
10 public:
11     // Default constructor
12     PassFailActivity() : GradedActivity()
13     { minPassingScore = 0.0; }
14
15     // Constructor
16     PassFailActivity(double mps) :
17     GradedActivity()
18     { minPassingScore = mps; }
19
20     // Mutator
21     void setMinPassingScore(double mps)
22     { minPassingScore = mps; }
```

```
22     // Accessors
23     double getMinPassingScore() const
24     { return minPassingScore; }
25
26     virtual char getLetterGrade() const;
27 };
28 #endif
```

The only change we have made to this class is to declare `getLetterGrade` as `virtual` in line 26. [Program 15-11](#) is identical to [Program 15-10](#), except it uses the corrected version of the `GradedActivity` and `PassFailActivity` classes. This file is also available in the student source code folder [Chapter 15](#)\GradedActivity Version 3.

## Program 15-11

```
1  #include <iostream>
2  #include <iomanip>
3  #include "PassFailActivity.h"
4  using namespace std;
5
6  // Function prototype
7  void displayGrade(const GradedActivity &);
8
9  int main()
10 {
11     // Create a PassFailActivity object.
12     // Minimum passing
13     // score is 70.
14     PassFailActivity test(70);
15
16     // Set the score to 72.
17     test.setScore(72);
18
19     // Display the object's grade data. The
20     // letter grade
21     // should be 'P'. What will be displayed?
22     displayGrade(test);
23     return 0;
```

```

22 }
23
24
//*****
*****
25 // The displayGrade function displays a
GradedActivity object's *
26 // numeric score and letter grade.
*
27
//*****
*****
28
29 void displayGrade(const GradedActivity
&activity)
30 {
31     cout << setprecision(1) << fixed;
32     cout << "The activity's numeric score is "
33         << activity.getScore() << endl;
34     cout << "The activity's letter grade is "
35         << activity.getLetterGrade() << endl;
36 }

```

## Program Output



```
The activity's numeric score is 72.0  
The activity's letter grade is P
```

Now that the `getLetterGrade` function is declared `virtual`, the program works properly. This type of behavior is known as polymorphism. The term *polymorphism* means the ability to take many forms. **Program 15-12** [□](#) demonstrates polymorphism by passing objects of the `GradedActivity` and `PassFailExam` classes to the `displayGrade` function. This file can be found in the Student Source Code Folder **Chapter 15** [□](#) \GradedActivity Version 3.

## Program 15-12

```
1  #include <iostream>
2  #include <iomanip>
3  #include "PassFailExam.h"
4  using namespace std;
5
6  // Function prototype
7  void displayGrade(const GradedActivity &);
8
9  int main()
10 {
11     // Create a GradedActivity object. The
12     score is 88.
13     GradedActivity test1(88.0);
14
15     // Create a PassFailExam object. There are
16     100 questions,
17     // the student missed 25 of them, and the
18     minimum passing
19     // score is 70.
20     PassFailExam test2(100, 25, 70.0);
21
22     // Display the grade data for both
23     objects.
```

```

20     cout << "Test 1:\n";
21     displayGrade(test1);    // GradedActivity
object
22     cout << "\nTest 2:\n";
23     displayGrade(test2);    // PassFailExam
object
24     return 0;
25 }
26
27
//*****
*****
28 // The displayGrade function displays a
GradedActivity object's *
29 // numeric score and letter grade.
*
30
//*****
*****
31
32 void displayGrade(const GradedActivity
&activity)
33 {
34     cout << setprecision(1) << fixed;
35     cout << "The activity's numeric score is "
36         << activity.getScore() << endl;
37     cout << "The activity's letter grade is "

```

```
38         << activity.getLetterGrade() << endl;  
39     }
```

## Program Output

```
Test 1:  
The activity's numeric score is 88.0  
The activity's letter grade is B  
  
Test 2:  
The activity's numeric score is 75.0  
The activity's letter grade is P
```

# Polymorphism Requires References or Pointers

The `displayGrade` function in Programs 15-11 and 15-12 uses a `GradedActivity` reference variable as its parameter. When we call the function, we pass an object by reference. Polymorphic behavior is not possible when an object is passed by value, however. For example, suppose the `displayGrade` function had been written as shown here:

```
// Polymorphic behavior is not possible with this function.
void displayGrade(const GradedActivity activity)
{
    cout << setprecision(1) << fixed;
    cout << "The activity's numeric score is "
         << activity.getScore() << endl;
    cout << "The activity's letter grade is "
         << activity.getLetterGrade() << endl;
}
```

In this version of the function, the `activity` parameter is an object variable, not a reference variable. Suppose we call this version of the function with the following code:

```
// Create a GradedActivity object. The score is 88.
GradedActivity test1(88.0);

// Create a PassFailExam object. There are 100 questions,
// the student missed 25 of them, and the minimum passing
// score is 70.
PassFailExam test2(100, 25, 70.0);

// Display the grade data for both objects.
cout << "Test 1:\n";
displayGrade(test1); // Pass the GradedActivity object
cout << "\nTest 2:\n";
displayGrade(&test2); // Pass the PassFailExam object
```

This code will produce the following output:

```
Test 1:
The activity's numeric score is 88.0
The activity's letter grade is B

Test 2:
The activity's numeric score is 75.0
The activity's letter grade is C
```

Even though the `getLetterGrade` function is declared `virtual`, static binding still takes place because `activity` is not a reference variable or a pointer.

Alternatively, we could have used a `GradedActivity` pointer in the `displayGrade` function, as shown in [Program 15-13](#). This file is also available in the Student Source Code Folder [Chapter 15](#)\GradedActivity Version 3.

## Program 15-13

```
1  #include <iostream>
2  #include <iomanip>
3  #include "PassFailExam.h"
4  using namespace std;
5
6  // Function prototype
7  void displayGrade(const GradedActivity *);
8
9  int main()
10 {
11     // Create a GradedActivity object. The
12     score is 88.
13     GradedActivity test1(88.0);
14
15     // Create a PassFailExam object. There are
16     100 questions,
17     // the student missed 25 of them, and the
18     minimum passing
19     // score is 70.
20     PassFailExam test2(100, 25, 70.0);
21
22     // Display the grade data for both
23     objects.
```



```

20     cout << "Test 1:\n";
21     displayGrade(&test1); // Address of the
GradedActivity object
22     cout << "\nTest 2:\n";
23     displayGrade(&test2); // Address of the
PassFailExam object
24     return 0;
25 }
26
27
//*****
*****
28 // The displayGrade function displays a
GradedActivity object's *
29 // numeric score and letter grade. This
version of the function *
30 // uses a GradedActivity pointer as its
parameter. *
31
//*****
*****
32
33 void displayGrade(const GradedActivity
*activity)
34 {
35     cout << setprecision(1) << fixed;
36     cout << "The activity's numeric score is "

```

```
37         << activity->getScore() << endl;
38         cout << "The activity's letter grade is "
39         << activity->getLetterGrade() <<
endl;
40     }
```

## Program Output

```
Test 1:
The activity's numeric score is 88.0
The activity's letter grade is B

Test 2:
The activity's numeric score is 75.0
The activity's letter grade is P
```



# Base Class Pointers

Pointers to a base class may be assigned the address of a derived class object. For example, look at the following code:

```
GradedActivity *exam = new PassFailExam(100, 25, 70.0);
```

This statement dynamically allocates a `PassFailExam` object and assigns its address to `exam`, which is a `GradedActivity` pointer. We can then use the `exam` pointer to call member functions, as shown here:

```
cout << exam->getScore() << endl;  
cout << exam->getLetterGrade() << endl;
```

**Program 15-14**  is an example that uses base class pointers to reference derived class objects. This file can be found in the Student Source Code Folder **Chapter 15**  \GradedActivity Version 3.

## Program 15-14

```
1  #include <iostream>
2  #include <iomanip>
3  #include "PassFailExam.h"
4  using namespace std;
5
6  // Function prototype
7  void displayGrade(const GradedActivity *);
8
9  int main()
10 {
11     // Constant for the size of an array.
12     const int NUM_TESTS = 4;
13
14     // tests is an array of GradedActivity
pointers.
15     // Each element of tests is initialized
with the
16     // address of a dynamically allocated
object.
17     GradedActivity *tests[NUM_TESTS] =
18         { new GradedActivity(88.0),
19           new PassFailExam(100, 25, 70.0),
20           new GradedActivity(67.0),
```

```

21         new PassFailExam(50, 12, 60.0)
22     };
23
24     // Display the grade data for each element
in the array.
25     for (int count = 0; count < NUM_TESTS;
count++)
26     {
27         cout << "Test #" << (count + 1) <<
":\n";
28         displayGrade(tests[count]);
29         cout << endl;
30     }
31     return 0;
32 }
33
34
//*****
*****
35 // The displayGrade function displays a
GradedActivity object's *
36 // numeric score and letter grade. This
version of the function *
37 // uses a GradedActivity pointer as its
parameter. *
38
//*****

```

```
*****
39
40 void displayGrade(const GradedActivity
*activity)
41 {
42     cout << setprecision(1) << fixed;
43     cout << "The activity's numeric score is "
44         << activity->getScore() << endl;
45     cout << "The activity's letter grade is "
46         << activity->getLetterGrade() <<
endl;
47 }
```

## Program Output

```
Test #1:  
The activity's numeric score is 88.0  
The activity's letter grade is B  
  
Test #2:  
The activity's numeric score is 75.0  
The activity's letter grade is P  
  
Test #3:  
The activity's numeric score is 67.0  
The activity's letter grade is D  
  
Test #4:  
The activity's numeric score is 76.0  
The activity's letter grade is P
```

Let's take a closer look at this program. An array named `tests` is defined in lines 17 through 22. This is an array of `GradedActivity` pointers. The array elements are initialized with the addresses of dynamically allocated objects. The `tests[0]` element is initialized with the address of the `GradedActivity` object returned from this expression:

```
new GradedActivity(88.0)
```

The `tests[1]` element is initialized with the address of the `GradedActivity` object returned from this expression:

```
new PassFailExam(100, 25, 70.0)
```

The `tests[2]` element is initialized with the address of the `GradedActivity` object returned from this expression:

```
new GradedActivity(67.0)
```

Finally, the `tests[3]` element is initialized with the address of the `GradedActivity` object returned from this expression:

```
new PassFailExam(50, 12, 60.0)
```

Although each element in the array is a `GradedActivity` pointer, some of the elements point to `GradedActivity` objects, and some point to `PassFailExam` objects. The loop in lines 25 through 30 steps



through the array, passing each pointer element to the `displayGrade` function.

# Base Class Pointers and References Know Only about Base Class Members

Although a base class pointer can reference objects of any class that derives from the base class, there are limits to what the pointer can do with those objects. Recall that the `GradedActivity` class has, other than its constructors, only three member functions: `setScore`, `getScore`, and `getLetterGrade`. So, a `GradedActivity` pointer can be used to call only those functions, regardless of the type of object to which it points. For example, look at the following code:

```
GradedActivity *exam = new PassFailExam(100, 25, 70.0);  
cout << exam->getScore() << endl; // This works.  
cout << exam->getLetterGrade() << endl; // This works.  
cout << exam->getPointsEach() << endl; // ERROR! Won't work!
```

In this code, `exam` is a `GradedActivity` pointer, and is assigned the address of a `PassFailExam` object. The `GradedActivity` class has only the `setScore`, `getScore`, and `getLetterGrade` member functions, so those are the only member functions the `exam` variable knows how to execute. The last statement in this code is a call to the `getPointsEach` member function, which is defined in the

`PassFailExam` class. Because the `exam` variable only knows about member functions in the `GradedActivity` class, it cannot execute this function.

# The “Is-a” Relationship Does Not Work in Reverse

It is important to note that the “is-a” relationship does not work in reverse. Although the statement “a final exam is a graded activity” is true, the statement “a graded activity is a final exam” is not true. This is because not all graded activities are final exams. Likewise, not all `GradedActivity` objects are `FinalExam` objects. So, the following code will not work:

```
// Create a GradedActivity object.  
GradedActivity *gaPointer = new GradedActivity(88.0);  
  
// Error! This will not work.  
FinalExam *fePointer = gaPointer;
```

You cannot assign the address of a `GradedActivity` object to a `FinalExam` pointer. This makes sense because `FinalExam` objects have capabilities that go beyond those of a `GradedActivity` object. Interestingly, the C++ compiler will let you make such an assignment if you use a type cast, as shown here:

```
// Create a GradedActivity object.  
GradedActivity *gaPointer = new GradedActivity(88.0);  
  
// This will work, but with limitations.  
FinalExam *fePointer = static_cast<FinalExam *>(gaPointer);
```

After this code executes, the derived class pointer `fePointer` will be pointing to a base class object. We can use the pointer to access members of the object, but only the members that exist. The following code demonstrates:

```
// This will work. The object has a getScore function.  
cout << fePointer->getScore() << endl;  
  
// This will work. The object has a getLetterGrade function.  
cout << fePointer->getLetterGrade() << endl;  
  
// This will compile, but an error will occur at runtime.  
// The object does not have a getPointsEach function.  
cout << fePointer->getPointsEach() << endl;
```


In this code, `fePointer` is a `FinalExam` pointer, and it points to a `GradedActivity` object. The first two `cout` statements work because the `GradedActivity` object has `getScore` and a

`getLetterGrade` member functions. The last `cout` statement will cause an error, however, because it calls the `getPointsEach` member function. The `GradedActivity` object does not have a `getPointsEach` member function.

## Redefining versus Overriding

Earlier in this chapter, you learned how a derived class can redefine a base class member function. When a class redefines a virtual function, it is said that the class *overrides* the function. In C++, the difference between overriding and redefining base class functions is that overridden functions are dynamically bound, and redefined functions are statically bound. Only virtual functions can be overridden.

# Virtual Destructors

When you write a class with a destructor, and that class could potentially become a base class, you should always declare the destructor `virtual`. This is because the compiler will perform static binding on the destructor if it is not declared `virtual`. This can lead to problems when a base class pointer or reference variable references a derived class object. If the derived class has its own destructor, it will not execute when the object is destroyed or goes out of scope. Only the base class destructor will execute. **Program 15-15**  demonstrates this.

## Program 15-15

```
1  #include <iostream>
2  using namespace std;
3
4  // Animal is a base class.
5  class Animal
6  {
7  public:
8      // Constructor
9      Animal()
10         { cout << "Animal constructor
11         executing.\n"; }
12
13     // Destructor
14     ~Animal()
15         { cout << "Animal destructor
16         executing.\n"; }
17 };
18
19 // The Dog class is derived from Animal
20 class Dog : public Animal
21 {
22 public:
23     // Constructor
```




```
22     Dog() : Animal()
23         { cout << "Dog constructor
executing.\n"; }
24
25     // Destructor
26     ~Dog()
27         { cout << "Dog destructor
executing.\n"; }
28 };
29
30
//*****
*
31 // main function
*
32
//*****
*
33
34 int main()
35 {
36     // Create a Dog object, referenced by an
37     // Animal pointer.
38     Animal *myAnimal = new Dog;
39
40     // Delete the dog object.
41     delete myAnimal;
```

```
42     return 0;
43 }
```

## Program Output

```
Animal constructor executing.
Dog constructor executing.
Animal destructor executing.
```

This program declares two classes: `Animal` and `Dog`. `Animal` is the base class and `Dog` is the derived class. Each class has its own constructor and destructor. In line 38, a `Dog` object is created, and its address is stored in an `Animal` pointer. Both the `Animal` and the `Dog` constructors execute. In line 41, the object is deleted. When this statement executes, however, only the `Animal` destructor executes. The `Dog` destructor does not execute because the object is referenced by an `Animal` pointer. We can fix this problem by declaring the `Animal` class destructor `virtual`, as shown in [Program 15-16](#) .

## Program 15-16

```
1  #include <iostream>
2  using namespace std;
3
4  // Animal is a base class.
5  class Animal
6  {
7  public:
8      // Constructor
9      Animal()
10         { cout << "Animal constructor
11         executing.\n"; }
12
13     // Destructor
14     virtual ~Animal()
15         { cout << "Animal destructor
16         executing.\n"; }
17 };
18
19 // The Dog class is derived from Animal
20 class Dog : public Animal
21 {
22 public:
23     // Constructor
```

```
22     Dog() : Animal()
23         { cout << "Dog constructor
executing.\n"; }
24
25     // Destructor
26     ~Dog()
27         { cout << "Dog destructor
executing.\n"; }
28 };
29
30
//*****
*
31 // main function
*
32
//*****
*
33
34 int main()
35 {
36     // Create a Dog object, referenced by an
37     // Animal pointer.
38     Animal *myAnimal = new Dog;
39
40     // Delete the dog object.
41     delete myAnimal;
```

```
42     return 0;
43 }
```

## Program Output


```
Animal constructor executing.
Dog constructor executing.
Dog destructor executing.
Animal destructor executing.
```

The only thing that has changed in this program is that the `Animal` class destructor is declared virtual in line 13. As a result, the destructor is dynamically bound at runtime. When the `Dog` object is destroyed, both the `Animal` and `Dog` destructors execute.

A good programming practice to follow is that any class that has a virtual member function should also have a virtual destructor. If the class doesn't require a destructor, it should have a virtual destructor that performs no statements. Remember, when a base class function is declared `virtual`, all overridden versions of the function in derived classes automatically become virtual. Including a virtual destructor in a base class, even one that does nothing, will ensure that any derived class destructors will also be virtual.

# C++ 11's `override` and `final`

## Key Words

**11** C++ 11 introduces the `override` key word to help prevent subtle errors when overriding virtual functions. For example, can you find the mistake in [Program 15-17](#) ?

## Program 15-17

```
1 // This program has a subtle error in the
virtual functions.
2 #include <iostream>
3 using namespace std;
4
5 class Base
6 {
7 public:
8     virtual void functionA(int arg) const
9         { cout << "This is Base::functionA" <<
endl; }
10 };
11
12 class Derived : public Base
13 {
14 public:
15     virtual void functionA(long arg) const
16         { cout << "This is Derived::functionA"
<< endl; }
17 };
18
19 int main()
20 {
```

```
21     // Allocate instances of the Derived
class.
22     Base *b = new Derived();
23     Derived *d = new Derived();
24
25     // Call functionA with the two pointers.
26     b->functionA(99);
27     d->functionA(99);
28
29     return 0;
30 }
```

## Program Output

```
This is Base::functionA
This is Derived::functionA
```



Both the `Base` class and the `Derived` class have a virtual member function named `functionA`.

Notice in lines 22 and 23 in the `main` function, we allocate two instances of the `Derived` class. We reference one of the instances with a `Base` class pointer (`b`), and we reference the other instance



with a `Derived` class pointer (`d`). When we call `functionA` in lines 26 and 27, we might expect that the `Derived` class's `functionA` would be called in both lines. This is not the case, however, as you can see from the program's output.

The `functionA` in the `Derived` class does not override the `functionA` in the `Base` class because the function signatures are different. The `functionA` in the `Base` class takes an `int` argument, but the one in the `Derived` class takes a `long` argument. So, `functionA` in the `Derived` class merely overloads `functionA` in the `Base` class.

To make sure a member function in a derived class overrides a virtual member function in a base class, you can use the `override` key word in the derived class's function prototype (or the function header, if the function is written inline). The `override` key word tells the compiler that the function is supposed to override a function in the base class. It will cause a compiler error if the function does not actually override any functions. [Program 15-18](#)  demonstrates how [Program 15-17](#)  can be fixed so the `Derived` class function does, in fact, override the `Base` class function. Notice in line 15 we have changed the parameter in the `Derived` class function to an `int`, and we have added the `override` key word to the function header.

## Program 15-18

```
1 // This program demonstrates the override key
word.
2 #include <iostream>
3 using namespace std;
4
5 class Base
6 {
7     public:
8         virtual void functionA(int arg) const
9         { cout << "This is Base::functionA" <<
endl; }
10 };
11
12 class Derived : public Base
13 {
14     public:
15         virtual void functionA(int arg) const
override
16         { cout << "This is Derived::functionA" <<
endl; }
17 };
18
19 int main()
```

```
20 {  
21     // Allocate instances of the Derived  
class.  
22     Base *b = new Derived();  
23     Derived *d = new Derived();  
24  
25     // Call functionA with the two pointers.  
26     b->functionA(99);  
27     d->functionA(99);  
28  
29     return 0;  
30 }
```

## Program Output

```
This is Derived::functionA
```

```
This is Derived::functionA
```

# Preventing a Member Function from Being Overridden

In some derived classes, you might want to make sure a virtual member function cannot be overridden any further down the class hierarchy. When a member function is declared with the `final` keyword, it cannot be overridden in a derived class. The following member function prototype is an example that uses the `final` keyword:

```
virtual void message() const final;
```

If a derived class attempts to override a `final` member function, the compiler generates an error.

# 15.7 Abstract Base Classes and Pure Virtual Functions

## Concept:

An abstract base class cannot be instantiated, but other classes are derived from it. A pure virtual function is a virtual member function of a base class that must be overridden. When a class contains a pure virtual function as a member, that class becomes an abstract base class.

Sometimes it is helpful to begin a class hierarchy with an *abstract base class*. An abstract base class is not instantiated itself, but serves as a base class for other classes. The abstract base class represents the generic, or abstract, form of all the classes that are derived from it.

For example, consider a factory that manufactures airplanes. The factory does not make a generic airplane, but makes three specific types of planes: two different models of prop-driven planes, and one commuter jet model. The computer software that catalogs the planes might use an abstract base class called `Airplane`. That class has

members representing the common characteristics of all airplanes. In addition, it has classes for each of the three specific airplane models the factory manufactures. These classes have members representing the unique characteristics of each type of plane. The base class, `Airplane`, is never instantiated, but is used to derive the other classes.

A class becomes an abstract base class when one or more of its member functions is a *pure virtual function*. A pure virtual function is a virtual member function declared in a manner similar to the following:

```
virtual void showInfo() = 0;
```

The `= 0` notation indicates that `showInfo` is a pure virtual function. Pure virtual functions have no body, or definition, in the base class. They must be overridden in derived classes. Additionally, the presence of a pure virtual function in a class prevents a program from instantiating the class. The compiler will generate an error if you attempt to define an object of an abstract base class.

For example, look at the following abstract base class `Student`. It holds data common to all students, but does not hold all the data needed for students of specific majors.

## Contents of `Student.h`

```
1 // Specification file for the Student class
2 #ifndef STUDENT_H
3 #define STUDENT_H
4 #include <string>
5 using namespace std;
6
7 class Student
8 {
9     protected:
10         string name; // Student name
11         string idNumber; // Student ID
12         int yearAdmitted; // Year student was
admitted
13     public:
14         // Default constructor
15         Student()
16             { name = "";
17              idNumber = "";
18              yearAdmitted = 0; }
19
20         // Constructor
21         Student(string n, string id, int year)
22             { set(n, id, year); }
```

```
23
24     // The set function sets the attribute
data.
25     void set(string n, string id, int year)
26         { name = n;           // Assign
the name
27             idNumber = id;     // Assign
the ID number
28             yearAdmitted = year; } // Assign
the year admitted
29
30     // Accessor functions
31     const string getName() const
32         { return name; }
33
34     const string getIdNum() const
35         { return idNumber; }
36
37     int getYearAdmitted() const
38         { return yearAdmitted; }
39
40     // Pure virtual function
41     virtual int getRemainingHours() const = 0;
42 };
43 #endif
```



The `Student` class contains members for storing a student's name, ID number, and year admitted. It also has constructors and a mutator function for setting values in the `name`, `idNumber`, and `yearAdmitted` members. Accessor functions are provided that return the values in the `name`, `idNumber`, and `yearAdmitted` members. A pure virtual function named `getRemainingHours` is also declared.

The pure virtual function must be overridden in classes derived from the `Student` class. It was made a pure virtual function because this class is intended to be the base for classes that represent students of specific majors. For example, a `CsStudent` class might hold the data for a computer science student, and a `BiologyStudent` class might hold the data for a biology student. Computer science students must take courses in different disciplines than those taken by biology students. It stands to reason that the `CsStudent` class will calculate the number of hours taken in a different manner than the `BiologyStudent` class.

Let's look at an example of the `CsStudent` class.

## Contents of `CsStudent.h`

```
1 // Specification file for the CsStudent class
2 #ifndef CSSTUDENT_H
3 #define CSSTUDENT_H
4 #include "Student.h"
5
6 // Constants for required hours
7 const int MATH_HOURS = 20; // Math hours
8 const int CS_HOURS = 40; // Computer
science hours
9 const int GEN_ED_HOURS = 60; // General Ed
hours
10
11 class CsStudent : public Student
12 {
13 private:
14     int mathHours; // Hours of math taken
15     int csHours; // Hours of Computer
Science taken
16     int genEdHours; // Hours of general
education taken
17
18 public:
19     // Default constructor
```

```
20     CsStudent() : Student()
21         { mathHours = 0;
22           csHours = 0;
23           genEdHours = 0; }
24
25     // Constructor
26     CsStudent(string n, string id, int year) :
27         Student(n, id, year)
28         { mathHours = 0;
29           csHours = 0;
30           genEdHours = 0; }
31
32     // Mutator functions
33     void setMathHours(int mh)
34         { mathHours = mh; }
35
36     void setCsHours(int csh)
37         { csHours = csh; }
38
39     void setGenEdHours(int geh)
40         { genEdHours = geh; }
41
42     // Overridden getRemainingHours function,
43     // defined in CsStudent.cpp
44     virtual int getRemainingHours() const;
45 };
46 #endif
```

This file declares the following `const int` member variables in lines 7 through 9: `MATH_HOURS`, `CS_HOURS`, and `GEN_ED_HOURS`. These variables hold the required number of math, computer science, and general education hours for a computer science student. The `CsStudent` class, which derives from the `Student` class, declares the following member variables in lines 14 through 16: `mathHours`, `csHours`, and `genEdHours`. These variables hold the number of math, computer science, and general education hours taken by the student. Mutator functions are provided to store values in these variables. In addition, the class overrides the pure virtual `getRemainingHours` function in the `CsStudent.cpp` file.

## Contents of `CsStudent.cpp`

```
1  #include <iostream>
2  #include "CsStudent.h"
3  using namespace std;
4
5
//*****
****
6  // The CsStudent::getRemainingHours function
returns *
7  // the number of hours remaining to be taken.
*
8
//*****
****
9
10 int CsStudent::getRemainingHours() const
11 {
12     int reqHours,    // Total required hours
13     remainingHours; // Remaining hours
14
15     // Calculate the required hours.
16     reqHours = MATH_HOURS + CS_HOURS +
GEN_ED_HOURS;
```

```
17
18     // Calculate the remaining hours.
19     remainingHours = reqHours - (mathHours +
20     csHours +
21     genEdHours);
22     // Return the remaining hours.
23     return remainingHours;
24 }
```

**Program 15-19**  provides a simple demonstration of the class.

## Program 15-19

```
1 // This program demonstrates the CsStudent
class, which is
2 // derived from the abstract base class,
Student.
3 #include <iostream>
4 #include "CsStudent.h"
5 using namespace std;
6
7 int main()
8 {
9     // Create a CsStudent object for a
student.
10     CsStudent student("Jennifer Haynes",
"167W98337", 2006);
11
12     // Store values for Math, Computer
Science, and General
13     // Ed hours.
14     student.setMathHours(12); // Student
has taken 12 Math hours
15     student.setCsHours(20); // Student
has taken 20 CS hours
16     student.setGenEdHours(40); // Student
```

```
has taken 40 Gen Ed hours
17
18     // Display the number of remaining hours.
19     cout << "The student " <<
student.getName()
20         << " needs to take " <<
student.getRemainingHours()
21         << " more hours to graduate.\n";
22
23     return 0;
24 }
```

## Program Output

```
The student Jennifer Haynes needs to take 48
more hours to graduate.
```

Remember the following points about abstract base classes and pure virtual functions:

- When a class contains a pure virtual function, it is an abstract base class.
- Pure virtual functions are declared with the = 0 notation.
- Abstract base classes cannot be instantiated.



- Pure virtual functions have no body, or definition, in the base class.
- A pure virtual function *must* be overridden at some point in a derived class in order for it to become nonabstract.



# Checkpoint

15.9 Explain the difference between overloading a function and redefining a function.

15.10 Explain the difference between static binding and dynamic binding.

15.11 Are virtual functions statically bound or dynamically bound?

15.12 What will the following program display?

```
#include <iostream.>

using namespace std;

class First
{
protected:
    int a;
public:
    First(int x = 1)
        { a = x; }
    int getVal()
        { return a; }
};

class Second : public First
{
private:
    int b;

public:
    Second(int y = 5)
        { b = y; }
    int getVal()
        { return b; }
};

int main()
```

```
{  
    First object1;  
    Second object2;  
  
    cout << object1.getVal() << endl;  
    cout << object2.getVal() << endl;  
    return 0;  
}
```

15.13 What will the following program display?

```
#include <iostream>

using namespace std;

class First
{
protected:
    int a;
public:
    First(int x = 1)
        { a = x; }

    void twist()
        { a *= 2; }

    int getVal()
        { twist(); return a; }
};

class Second : public First
{
private:
    int b;
public:
    Second(int y = 5)
        { b = y; }

    void twist()
        { b *= 10; }
};
```

```
int main()
{
    First object1;
    Second object2;

    cout << object1.getVal() << endl;
    cout << object2.getVal() << endl;

    return 0;
}
```

15.14 What will the following program display?

```
#include <iostream>
using namespace std;

class First
{
protected:
    int a;
public:
    First(int x = 1)
        { a = x; }

    virtual void twist()
        { a *= 2; }

    int getVal()
        { twist(); return a; }
};

class Second : public First
{
private:
    int b;
public:
    Second(int y = 5)
        { b = y; }

    virtual void twist()
        { b *= 10; }
```

```
};  
  
int main()  
{  
    First object1;  
    Second object2;  
    cout << object1.getVal() << endl;  
    cout << object2.getVal() << endl;  
    return 0;  
}
```

15.15 What will the following program display?



```
#include <iostream>

using namespace std;

class Base
{
protected:
    int baseVar;
public:
    Base(int val = 2)
        { baseVar = val; }
    int getVar()
        { return baseVar; }
};

class Derived : public Base
{
private:
    int derivedVar;
public:
    Derived(int val = 100)
        { derivedVar = val; }
    int getVar()
        { return derivedVar; }
};


int main()
{
```

## 15.8 Multiple Inheritance

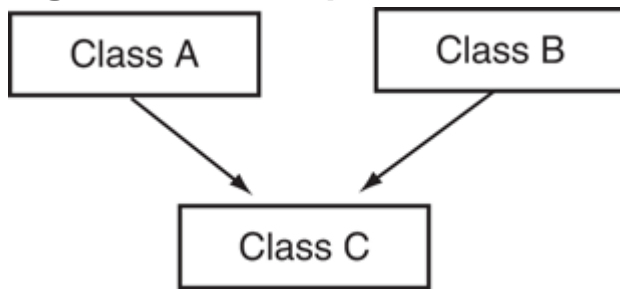
### **Concept:**

Multiple inheritance is when a derived class has two or more base classes.

Previously, we discussed how a class may be derived from a second class that is itself derived from a third class. The series of classes establishes a chain of inheritance. In such a scheme, you might be tempted to think of the lowest class in the chain as having multiple base classes. A base class, however, should be thought of as the class that another class is directly derived from. Even though there may be several classes in a chain, each class (below the topmost class) only has one base class.

Another way of combining classes is through multiple inheritance. *Multiple inheritance* is when a class has two or more base classes. This is illustrated in [Figure 15-6](#) .

**Figure 15-6 Multiple inheritance**



In [Figure 15-6](#), class C is directly derived from classes A and B and inherits the members of both. Neither class A nor B, however, inherits members from the other. Their members are only passed down to class C. Let's look at an example of multiple inheritance. Consider the two classes declared here:

## Contents of `Date.h`

```
1 // Specification file for the Date class
2 #ifndef DATE_H
3 #define DATE_H
4
5 class Date
6 {
7     protected:
8         int day;
9         int month;
10        int year;
11    public:
12        // Default constructor
13        Date(int d, int m, int y)
14            { day = 1; month = 1; year = 1900; }
15
16        // Constructor
17        Date(int d, int m, int y)
18            { day = d; month = m; year = y; }
19
20        // Accessors
21        int getDay() const
22            { return day; }
23
```

```
24     int getMonth() const
25         { return month; }
26
27     int getYear() const
28         { return year; }
29 };
30 #endif
```

## Contents of `Time.h`

```
1 // Specification file for the Time class
2 #ifndef TIME_H
3 #define TIME_H
4
5 class Time
6 {
7     protected:
8         int hour;
9         int min;
10        int sec;
11    public:
12        // Default constructor
13        Time()
14            { hour = 0; min = 0; sec = 0; }
15
16        // Constructor
17        Time(int h, int m, int s)
18            { hour = h; min = m; sec = s; }
19
20        // Accessor functions
21        int getHour() const
22            { return hour; }
23
```

```
24     int getMin() const
25         { return min; }
26
27     int getSec() const
28         { return sec; }
29 };
30 #endif
```

These classes are designed to hold integers that represent the date and time. They both can be used as base classes for a third class we will call `DateTime`:

## Contents of `DateTime.h`

```
1 // Specification file for the DateTime class
2 #ifndef DATETIME_H
3 #define DATETIME_H
4 #include <string>
5 #include "Date.h"
6 #include "Time.h"
7 using namespace std;
8
9 class DateTime : public Date, public Time
10 {
11 public:
12     // Default constructor
13     DateTime();
14
15     // Constructor
16     DateTime(int, int, int, int, int, int);
17
18     // The showDateTime function displays the
19     // date and the time.
20     void showDateTime() const;
```



```
21 };  
22 #endif
```

In line 9, the first line in the `DateTime` declaration reads

```
class DateTime : public Date, public Time
```

Notice there are two base classes listed, separated by a *comma*. Each base class has its own access specification. The general format of the first line of a class declaration with multiple base classes is

```
class DerivedClassName : AccessSpecification BaseClassName,  
                        AccessSpecification BaseClassName [  
...]
```

The notation in the square brackets indicates that the list of base classes with their access specifications may be repeated. (It is possible to have several base classes.)

## Contents of `DateTime.cpp`

```
1 // Implementation file for the DateTime class
2 #include <iostream>
3 #include <string>
4 #include "DateTime.h"
5 using namespace std;
6
7
8 //*****
9 // Default constructor
10 *
11 // Note that this constructor does nothing
12 other *
13 // than call default base class constructors.
14 *
15
16 //*****
17 DateTime::DateTime() : Date(), Time()
18 {}
19
20
21 //*****
22 // Constructor
23 *
```

```

17 // Note that this constructor does nothing
other *
18 // than call base class constructors.
*
19
//*****
20 DateTime::DateTime(int dy, int mon, int yr,
int hr, int mt, int sc) :
21     Date(dy, mon, yr), Time(hr, mt, sc)
22 {}
23
24
//*****
25 // The showDateTime member function displays
the *
26 // date and the time.
*
27
//*****
28 void DateTime::showDateTime() const
29 {
30     // Display the date in the form
MM/DD/YYYY.
31     cout << getMonth() << "/" << getDay() <<
"/" << getYear() << " ";
32
33     // Display the time in the form HH:MM:SS.

```

```
34     cout << getHour() << ":" << getMin() <<
    ":" << getSec() << endl;
35 }
```

The class has two constructors: a default constructor and a constructor that accepts arguments for each component of a date and time. Let's look at the function header for the default constructor, in line 12:

```
DateTime::DateTime() : Date(), Time()
```

After the `DateTime` constructor's parentheses is a colon, followed by calls to the `Date` constructor and the `Time` constructor. The calls are separated by a comma. When using multiple inheritance, the general format of a derived class's constructor header is

```
DerivedClassName(ParameterList) : BaseClassName(ArgumentList),
                                   BaseClassName(ArgumentList) [,
...]
```


Look at the function header for the second constructor, which appears in lines 20 and 21:

```
DateTime::DateTime(int dy, int mon, int yr, int hr, int mt, int
sc) :
    Date(dy, mon, yr), Time(hr, mt, sc)
```

This `DateTime` constructor accepts arguments for the day (`dy`), month (`mon`), year (`yr`), hour (`hr`), minute (`mt`), and second (`sc`). The `dy`, `mon`, and `yr` parameters are passed as arguments to the `Date` constructor. The `hr`, `mt`, and `sc` parameters are passed as arguments to the `Time` constructor.

The order that the base class constructor calls appear in the list does not matter. They are always called in the order of inheritance. That is, they are always called in the order they are listed in the first line of the class declaration. Here is line 9 from the `DateTime.h` file:

```
class DateTime : public Date, public Time
```

Because `Date` is listed before `Time` in the `DateTime` class declaration, the `Date` constructor will always be called first. If the classes use destructors, they are always called in reverse order of inheritance. [Program 15-20](#)  shows these classes in use.

## Program 15-20

```
1 // This program demonstrates a class with
multiple inheritance.
2 #include "DateTime.h"
3 using namespace std;
4
5 int main()
6 {
7     // Define a DateTime object and use the
default
8     // constructor to initialize it.
9     DateTime emptyDay;
10
11     // Display the object's date and time.
12     emptyDay.showDateTime();
13
14     // Define a DateTime object and initialize
it
15     // with the date 2/4/1960 and the time
5:32:27.
16     DateTime pastDay(2, 4, 1960, 5, 32, 27);
17
18     // Display the object's date and time.
19     pastDay.showDateTime();
```

```
20     return 0;  
21 }
```

## Program Output

```
1/1/1900 0:0:0  
4/2/1960 5:32:27
```



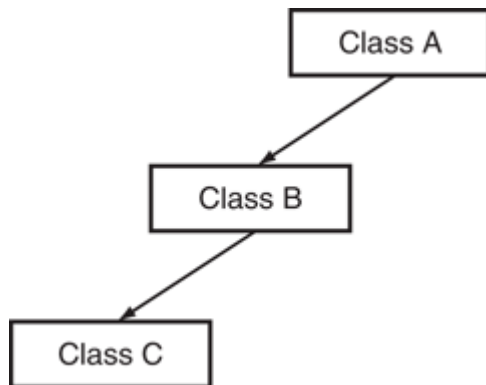
## Note:

It should be noted that multiple inheritance opens the opportunity for a derived class to have ambiguous members. That is, two base classes may have member variables or functions of the same name. In situations like these, the derived class should always redefine or override the member functions. Calls to the member functions of the appropriate base class can be performed within the derived class using the scope resolution operator (`::`). The derived class can also access the ambiguously named member variables of the correct base class using the scope resolution operator. If these steps aren't taken, the compiler will generate an error when it can't tell which member is being accessed.

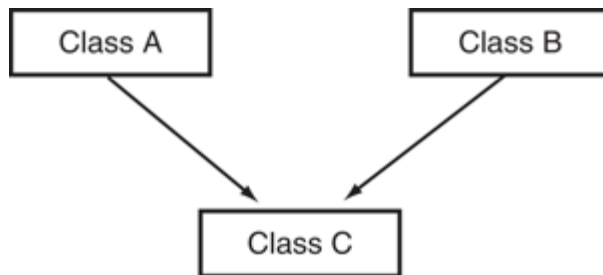


# Checkpoint

15.16 Does the following diagram depict multiple inheritance or a chain of inheritance?



15.17 Does the following diagram depict multiple inheritance or a chain of inheritance?



15.18 Examine the following classes. The table lists the variables that are members of the `Third` class (some are inherited). Complete the table by filling in the access specification each member will have in the `Third` class. Write “inaccessible” if a member is inaccessible to the `Third` class.

```
class First
{
    private:
        int a;
    protected:
        double b;
    public:
        long c;
};

class Second : protected First
{
    private:
        int d;
    protected:
        double e;
    public:
        long f;
};

class Third : public Second
{
    private:
        int g;
    protected:
        double h;
    public:
```

```
    long i;  
};
```

### 15.19 Examine the following class declarations:

```
class Van  
{  
protected:  
    int passengers;  
public:  
    Van(int p)  
    { passengers = p; }  
};  
class FourByFour  
{  
protected:  
    double cargoWeight;  
public:  
    FourByFour(float w)  
    { cargoWeight = w; }  
};
```

Write the declaration of a class named `SportUtility`. The class should be derived from both the `Van` and `FourByFour` classes above. (This should be a case of multiple inheritance, where both `Van` and `FourByFour` are base classes.)

# Review Questions and Exercises

## Short Answer

1. What is an “is a” relationship?
2. A program uses two classes: `Dog` and `Poodle`. Which class is the base class, and which is the derived class?
3. How does base class access specification differ from class member access specification?
4. What is the difference between a protected class member and a private class member?
5. Can a derived class ever directly access the private members of its base class?
6. Which constructor is called first, that of the derived class or the base class?
7. What is the difference between redefining a base class function and overriding a base class function?
8. When does static binding take place? When does dynamic binding take place?
9. What is an abstract base class?
10. A program has a class `Potato`, which is derived from the class `Vegetable`, which is derived from the class `Food`. Is this an example of multiple inheritance? Why or why not?
11. What base class is named in the line below?

```
class Pet : public Dog
```

12. What derived class is named in the line below?

```
class Pet : public Dog
```

13. What is the class access specification of the base class named below?

```
class Pet : public Dog
```

14. What is the class access specification of the base class named below?

```
class Pet : Fish
```

15. Protected members of a base class are like \_\_\_\_\_ members, except they may be accessed by derived classes.
16. Complete the table on the next page by filling in private, protected, public, or inaccessible in the right-hand column:
17. Complete the table below by filling in private, protected, public, or inaccessible in the right-hand column:
18. Complete the table below by filling in private, protected, public, or inaccessible in the right-hand column:

# Fill-in-the-Blank

19. A derived class inherits the \_\_\_\_\_ of its base class.
20. When both a base class and a derived class have constructors, the base class's constructor is called \_\_\_\_\_ (first/last).
21. When both a base class and a derived class have destructors, the base class's constructor is called \_\_\_\_\_ (first/last).
22. An overridden base class function may be called by a function in a derived class by using the \_\_\_\_\_ operator.
23. When a derived class redefines a function in a base class, which version of the function do objects that are defined of the base class call? \_\_\_\_\_
24. A(n) \_\_\_\_\_ member function in a base class expects to be overridden in a derived class.
25. \_\_\_\_\_ binding is when the compiler binds member function calls at compile time.
26. \_\_\_\_\_ binding is when a function call is bound at runtime.
27. \_\_\_\_\_ is when member functions in a class hierarchy behave differently, depending upon which object performs the call.
28. When a pointer to a base class is made to point to a derived class, the pointer ignores any \_\_\_\_\_ the derived class performs, unless the function is \_\_\_\_\_.
29. A(n) \_\_\_\_\_ class cannot be instantiated.

30. A(n) \_\_\_\_\_ function has no body, or definition, in the class in which it is declared.
31. A(n) \_\_\_\_\_ of inheritance is where one class is derived from a second class, which in turn is derived from a third class.
32. \_\_\_\_\_ is where a derived class has two or more base classes.
33. In multiple inheritance, the derived class should always \_\_\_\_\_ a function that has the same name in more than one base class.

# Algorithm Workbench

34. Write the first line of the declaration for a `Poodle` class. The class should be derived from the `Dog` class with public base class access.
35. Write the first line of the declaration for a `SoundSystem` class. Use multiple inheritance to base the class on the `CDplayer` class, the `Tuner` class, and the `MP3Player` class. Use public base class access in all cases.
36. Suppose a class named `Tiger` is derived from both the `Felis` class and the `Carnivore` class. Here is the first line of the `Tiger` class declaration:

```
class Tiger : public Felis, public Carnivore
```

Here is the function header for the `Tiger` constructor:

```
Tiger(int x, int y) : Carnivore(x), Felis(y)
```

Which base class constructor is called first, `Carnivore` or `Felis`?

37. Write the declaration for class `B`. The class's members should be as follows:
  - `m`: an integer. This variable should not be accessible to code outside the class or to member functions in any class



derived from class `B`.

- `n`: an integer. This variable should not be accessible to code outside the class, but should be accessible to member functions in any class derived from class `B`.
- `setM`, `getM`, `setN`, and `getN`: These are the set and get functions for the member variables `m` and `n`. These functions should be accessible to code outside the class.
- `calc`: a public virtual member function that returns the value of `m` times `n`.

Next, write the declaration for class `D`, which is derived from class `B`. The class's members should be as follows:

- `q`: a `float`. This variable should not be accessible to code outside the class but should be accessible to member functions in any class derived from class `D`.
- `r`: a `float`. This variable should not be accessible to code outside the class, but should be accessible to member functions in any class derived from class `D`.
- `setQ`, `getQ`, `setR`, and `getR`: These are the set and get functions for the member variables `q` and `r`. These functions should be accessible to code outside the class.
- `calc`: a public member function that overrides the base class `calc` function. This function should return the value of `q` times `r`.

# True or False

38. T F The base class's access specification affects the way base class member functions may access base class member variables.
39. T F The base class's access specification affects the way the derived class inherits members of the base class.
40. T F Private members of a private base class become inaccessible to the derived class.
41. T F Public members of a private base class become private members of the derived class.
42. T F Protected members of a private base class become public members of the derived class.
43. T F Public members of a protected base class become private members of the derived class.
44. T F Private members of a protected base class become inaccessible to the derived class.
45. T F Protected members of a public base class become public members of the derived class.
46. T F The base class constructor is called after the derived class constructor.
47. T F The base class destructor is called after the derived class destructor.
48. T F It isn't possible for a base class to have more than one constructor.
49. T F Arguments are passed to the base class constructor by the derived class constructor.

50. T F A member function of a derived class may not have the same name as a member function of the base class.
51. T F Pointers to a base class may be assigned the address of a derived class object.
52. T F A base class may not be derived from another class.

# Find the Errors

Each of the class declarations and/or member function definitions below has errors. Find as many as you can.

53. 

```
class Car, public Vehicle
{
    public:
        Car();
        ~Car();
    protected:
        int passengers;
}
```

54. 

```
class Truck, public : Vehicle, protected
{
    private:
        double cargoWeight;
    public:
        Truck();
        ~Truck();
};
```

55.

```
class SnowMobile : Vehicle
{
    protected:
        int horsepower;
        double weight;
    public:
        SnowMobile(int h, double w), Vehicle(h)
        { horsepower = h; }
        ~SnowMobile();
};
```

56.

```
class Table : public Furniture
{
    protected:
        int numSeats;
    public:
        Table(int n) : Furniture(numSeats)
        { numSeats = n; }
        ~Table();
};
```

57.

```
class Tank : public Cylinder
{
    private:
        int fuelType;
        double gallons;
    public:
        Tank();
        ~Tank();
        void setContents(double);
        void setContents(double);
};
```

58.

```
class Three : public Two : public One
{
    protected:
        int x;
    public:
        Three(int a, int b, int c), Two(b), Three(c)
        { x = a; }
        ~Three();
};
```

# Programming Challenges

## 1. `Employee` and `ProductionWorker` Classes



### Solving the `Employee` and `ProductionWorker` Classes Problem

Design a class named `Employee`. The class should keep the following information:

- Employee name
- Employee number
- Hire date

Write one or more constructors, and the appropriate accessor and mutator functions, for the class.

Next, write a class named `ProductionWorker` that is derived from the `Employee` class. The `ProductionWorker` class

should have member variables to hold the following information:

- Shift (an integer)
- Hourly pay rate (a `double`)

The workday is divided into two shifts: day and night. The shift variable will hold an integer value representing the shift that the employee works. The day shift is shift 1, and the night shift is shift 2. Write one or more constructors, and the appropriate accessor and mutator functions, for the class. Demonstrate the classes by writing a program that uses a `ProductionWorker` object.

## 2. `ShiftSupervisor` Class

In a particular factory, a shift supervisor is a salaried employee who supervises a shift. In addition to a salary, the shift supervisor earns a yearly bonus when his or her shift meets production goals. Design a `ShiftSupervisor` class that is derived from the `Employee` class you created in Programming Challenge 1 (Employee and Production Worker Classes). The `ShiftSupervisor` class should have a member variable that holds the annual salary, and a member variable that holds the annual production bonus that a shift supervisor has earned. Write one or more constructors and the appropriate accessor and mutator functions for the class. Demonstrate the class by writing a program that uses a `ShiftSupervisor` object.

## 3. `TeamLeader` Class



In a particular factory, a team leader is an hourly paid production worker who leads a small team. In addition to hourly pay, team leaders earn a fixed monthly bonus. Team leaders are required to attend a minimum number of hours of training per year. Design a `TeamLeader` class that extends the `ProductionWorker` class you designed in Programming Challenge 1 (Employee and Production Worker Classes). The `TeamLeader` class should have member variables for the monthly bonus amount, the required number of training hours, and the number of training hours that the team leader has attended. Write one or more constructors and the appropriate accessor and mutator functions for the class. Demonstrate the class by writing a program that uses a `TeamLeader` object.

#### 4. Time Format

In [Program 15-20](#), the file `Time.h` contains a `Time` class. Design a class called `MilTime` that is derived from the `Time` class. The `MilTime` class should convert time in military (24-hour) format to the standard time format used by the `Time` class. The class should have the following member variables:  
The class should have the following member functions:  
Demonstrate the class in a program that asks the user to enter the time in military format. The program should then display the time in both military and standard format.  
*Input Validation: The `MilTime` class should not accept hours greater than 2359, or less than 0. It should not accept seconds greater than 59 or less than 0.*

#### 5. Time Clock

Design a class named `TimeClock`. The class should be derived from the `MilTime` class you designed in Programming Challenge 4 (Time Format). The class should allow the programmer to pass two times to it: starting time and ending time. The class should have a member function that returns the amount of time elapsed between the two times. For example, if the starting time is 900 hours (9:00 a.m.), and the ending time is 1300 hours (1:00 p.m.), the elapsed time is 4 hours.

*Input Validation: The class should not accept hours greater than 2359 or less than 0.*

## 6. `Essay` Class

Design an `Essay` class that is derived from the `GradedActivity` class presented in this chapter. The `Essay` class should determine the grade a student receives on an essay. The student's essay score can be up to 100, and is determined in the following manner:

- Grammar: 30 points
- Spelling: 20 points
- Correct length: 20 points
- Content: 30 points

Demonstrate the class in a simple program.

## 7. `PersonData` and `CustomerData` Classes

Design a class named `PersonData` with the following member variables:

- `lastName`

- `firstName`
- `address`
- `city`
- `state`
- `zip`
- `phone`

Write the appropriate accessor and mutator functions for these member variables.

Next, design a class named `CustomerData`, which is derived from the `PersonData` class. The `CustomerData` class should have the following member variables:

- `customerNumber`
- `mailingList`

The `customerNumber` variable will be used to hold a unique integer for each customer. The `mailingList` variable should be a `bool`. It will be set to `true` if the customer wishes to be on a mailing list, or `false` if the customer does not wish to be on a mailing list. Write appropriate accessor and mutator functions for these member variables. Demonstrate an object of the `CustomerData` class in a simple program.

## 8. `PreferredCustomer` Class

A retail store has a preferred customer plan where customers may earn discounts on all their purchases. The amount of a customer's discount is determined by the amount of the customer's cumulative purchases in the store.

- When a preferred customer spends \$500, he or she gets a 5 percent discount on all future purchases.
- When a preferred customer spends \$1,000, he or she gets a 6 percent discount on all future purchases.
- When a preferred customer spends \$1,500, he or she gets a 7 percent discount on all future purchases.
- When a preferred customer spends \$2,000 or more, he or she gets a 10 percent discount on all future purchases.

Design a class named `PreferredCustomer`, which is derived from the `CustomerData` class you created in Programming Challenge 7. The `PreferredCustomer` class should have the following member variables:

- `purchasesAmount` (a `double`)
- `discountLevel` (a `double`)

The `purchasesAmount` variable holds the total of a customer's purchases to date. The `discountLevel` variable should be set to the correct discount percentage, according to the store's preferred customer plan. Write appropriate member functions for this class and demonstrate it in a simple program.

*Input Validation: Do not accept negative values for any sales figures.*

## 9. File Filter

A file filter reads an input file, transforms it in some way, and writes the results to an output file. Write an abstract file filter class that defines a pure virtual function for transforming a character. Create one derived class of your file filter class that

performs encryption, another that transforms a file to all uppercase, and another that creates an unchanged copy of the original file. The class should have the following member function:

```
void doFilter(ifstream &in, ofstream &out)
```

This function should be called to perform the actual filtering. The member function for transforming a single character should have the prototype:

```
char transform(char ch)
```

The encryption class should have a constructor that takes an integer as an argument and uses it as the encryption key.

## 10. File Double-Spacer

Create a derived class of the abstract filter class of Programming Challenge 9 (File Filter) that double-spaces a file, that is, it inserts a blank line between any two lines of the file.

## 11. Course Grades

In a course, a teacher gives the following tests and assignments:

- A **lab activity** that is observed by the teacher and assigned a numeric score.
- A **pass/fail exam** that has ten questions. The minimum passing score is 70.

- An **essay** that is assigned a numeric score.
- A **final exam** that has 50 questions.

Write a class named `CourseGrades`. The class should have a member named `grades` that is an array of `GradedActivity` pointers. The `grades` array should have four elements, one for each of the assignments previously described. The class should have the following member functions:

Demonstrate the class in a program.

## 12. `Ship`, `CruiseShip`, and `CargoShip` Classes

Design a `Ship` class that has the following members:

- A member variable for the name of the ship (a string)
- A member variable for the year that the ship was built (a string)
- A constructor and appropriate accessors and mutators
- A virtual `print` function that displays the ship's name and the year it was built.

Design a `CruiseShip` class that is derived from the `Ship` class. The `CruiseShip` class should have the following members:

- A member variable for the maximum number of passengers (an `int`)
- A constructor and appropriate accessors and mutators
- A `print` function that overrides the `print` function in the base class. The `CruiseShip` class's `print` function should

display only the ship's name and the maximum number of passengers.

Design a `CargoShip` class that is derived from the `Ship` class. The `CargoShip` class should have the following members:

- A member variable for the cargo capacity in tonnage (an `int`)
- A constructor and appropriate accessors and mutators
- A `print` function that overrides the `print` function in the base class. The `CargoShip` class's print function should display only the ship's name and the ship's cargo capacity.

Demonstrate the classes in a program that has an array of `Ship` pointers. The array elements should be initialized with the addresses of dynamically allocated `Ship`, `CruiseShip`, and `CargoShip` objects. (See [Program 15-14](#), lines 17 through 22, for an example of how to do this.) The program should then step through the array, calling each object's `print` function.

### 13. Pure Abstract Base Class Project

Define a pure abstract base class called `BasicShape`. The `BasicShape` class should have the following members:

Private Member Variable:

```
area: A double used to hold the shape's area.
```

Public Member Functions:

`getArea`: This function should return the value in the member variable `area`.

`calcArea`: This function should be a pure virtual function.

Next, define a class named `Circle`. It should be derived from the `BasicShape` class. It should have the following members:

Private Member Variables:

`centerX`: a long integer used to hold the x coordinate of the circle's center

`centerY`: a long integer used to hold the y coordinate of the circle's center

`radius`: a double used to hold the circle's radius

Public Member Functions:

constructor: accepts values for `centerX`, `centerY`, and `radius`. Should call the overridden `calcArea` function described below.

`getCenterX`: returns the value in `centerX`

`getCenterY`: returns the value in `centerY`

`calcArea`: calculates the area of the circle (area = 3.14159 \* radius \* radius) and stores the result in the inherited member `area`.



Next, define a class named `Rectangle`. It should be derived from the `BasicShape` class. It should have the following members:

Private Member Variables:

`width`: a long integer used to hold the width of the rectangle

`length`: a long integer used to hold the length of the rectangle

Public Member Functions:

`constructor`: accepts values for width and length. Should call the overridden `calcArea` function described below.

`getWidth`: returns the value in width.

`getLength`: returns the value in length.

`calcArea`: calculates the area of the rectangle (area = length \* width) and stores the result in the inherited member area.

After you have created these classes, create a driver program that defines a `Circle` object and a `Rectangle` object.

Demonstrate that each object properly calculates and reports its area.

# Group Project

## 14. Bank Accounts

This program should be designed and written by a team of students. Here are some suggestions:

- One or more students may work on a single class.
- The requirements of the program should be analyzed so that each student is given about the same work load.
- The parameters and return types of each function and class member function should be decided in advance.
- The program will be best implemented as a multi-file program.

Design a generic class to hold the following information about a bank account:

- Balance
- Number of deposits this month
- Number of withdrawals
- Annual interest rate
- Monthly service charges

The class should have the following member functions:

Next, design a savings account class, derived from the generic account class. The savings account class should have the following additional member:

```
status (to represent an active or inactive account)
```

If the balance of a savings account falls below \$25, it becomes inactive. (The `status` member could be a flag variable.) No more withdrawals may be made until the balance is raised above \$25, at which time the account becomes active again. The savings account class should have the following member functions:

Next, design a checking account class, also derived from the generic account class. It should have the following member functions:

Write a complete program that demonstrates these classes by asking the user to enter the amounts of deposits and withdrawals for a savings account and checking account. The program should display statistics for the month, including beginning balance, total amount of deposits, total amount of withdrawals, service charges, and ending balance.



**Note:**

You may need to add more member variables and functions to the classes than those listed above.

---

# Chapter **16** Exceptions and Templates

---

## Topics

**16.1 Exceptions** 

**16.2 Function Templates** 

**16.3 Focus on Software Engineering: Where to Start When Defining Templates** 

**16.4 Class Templates** 

## 16.1 Exceptions

### Concept:

Exceptions are used to signal errors or unexpected events that occur while a program is running.

Error testing is usually a straightforward process involving `if` statements or other control mechanisms. For example, the following code segment will trap a division-by-zero error before it occurs:

```
if (denominator == 0)
    cout << "ERROR: Cannot divide by zero.\n";
else
    quotient = numerator / denominator;
```

But what if similar code is part of a function that returns the quotient, as in the following example?

```
// An unreliable division function
double divide(int numerator, int denominator)
{
    if (denominator == 0)
    {
        cout << "ERROR: Cannot divide by zero.\n";
        return 0;
    }
    else
        return static_cast<double>(numerator) / denominator;
}
```

Functions commonly signal error conditions by returning a predetermined value. Apparently, the function in this example returns 0 when division by zero has been attempted. This is unreliable, however, because 0 is a valid result of a division operation. Even though the function displays an error message, the part of the program that calls the function will not know when an error has occurred. Problems like these require sophisticated error handling techniques.

# Throwing an Exception

One way of handling complex error conditions is with *exceptions*. An exception is a value or an object that signals an error. When the error occurs, an exception is “thrown.” For example, the following code shows the `divide` function, modified to throw an exception when division by zero has been attempted:

```
double divide(int numerator, int denominator)
{
    if (denominator == 0)
        throw "ERROR: Cannot divide by zero.\n";
    else
        return static_cast<double>(numerator) / denominator;
}
```



## Throwing an Exception

The following statement causes the exception to be thrown:

```
throw "ERROR: Cannot divide by zero.\n";
```

The `throw` key word is followed by an argument, which can be any value. As you will see, the value of the argument is used to determine the nature of the error. The function above simply throws a string containing an error message.

The line containing a `throw` statement is known as the *throw point*. When a `throw` statement is executed, control is passed to another part of the program known as an *exception handler*. When an exception is thrown by a function, the function aborts.

# Handling an Exception

To handle an exception, a program must have a *try/catch* construct. The general format of the try/catch construct is:

```
try
{
    // code here calls functions or object member
    // functions that might throw an exception.
}
catch(ExceptionParameter)
{
    // code here handles the exception
}
// Repeat as many catch blocks as needed.
```



## Handling an Exception

The first part of the construct is the *try block*. This starts with the key word `try` and is followed by a block of code executing any statements that might directly or indirectly cause an exception to be thrown. The try block is immediately followed by one or more *catch blocks*, which are the exception handlers. A catch block starts with the key word `catch`, followed by a set of parentheses containing the definition of an exception parameter. For example, here is a try/catch construct that can be used with the `divide` function:

```
try
{
    quotient = divide(num1, num2);
    cout << "The quotient is " << quotient << endl;
}
catch (string exceptionString)
{
    cout << exceptionString;
}
```

Because the `divide` function throws an exception whose value is a string, there must be an exception handler that catches a string. The catch block shown catches the error message in the `exceptionString` parameter then displays it with `cout`. Now let's look at an entire program to see how `throw`, `try`, and `catch` work together. In the first sample run of [Program 16-1](#), valid data are given. This shows how the program should run with no errors. In the second sample running, a denominator of 0 is given. This shows the result of the exception being thrown.



## Program 16-1

```
1 // This program demonstrates an exception being thrown and caught.
2 #include <iostream>
3 #include <string>
4 using namespace std;
5
6 // Function prototype
7 double divide(int, int);
8
9 int main()
10 {
11     int num1, num2; // To hold two numbers
12     double quotient; // To hold the quotient of the numbers
13
14     // Get two numbers.
15     cout << "Enter two numbers: ";
16     cin >> num1 >> num2;
17
18     // Divide num1 by num2 and catch any
19     // potential exceptions.
20     try
21     {
22         quotient = divide(num1, num2);
23         cout << "The quotient is " << quotient << endl;
24     }
25     catch (string exceptionString)
26     {
27         cout << exceptionString;
28     }
29
30     cout << "End of the program.\n";
31     return 0;
32 }
33
34 //*****
35 // The divide function divides the numerator *
36 // by the denominator. If the denominator is *
37 // zero, the function throws an exception. *
```


```
38 //*****
39
40 double divide(int numerator, int denominator)
41 {
42     if (denominator == 0)
43     {
44         string exceptionString = "ERROR: Cannot divide by zero.\n";
45         throw exceptionString;
46     }
47
48     return static_cast<double>(numerator) / denominator;
49 }
```

### Program Output with Example Input Shown in Bold

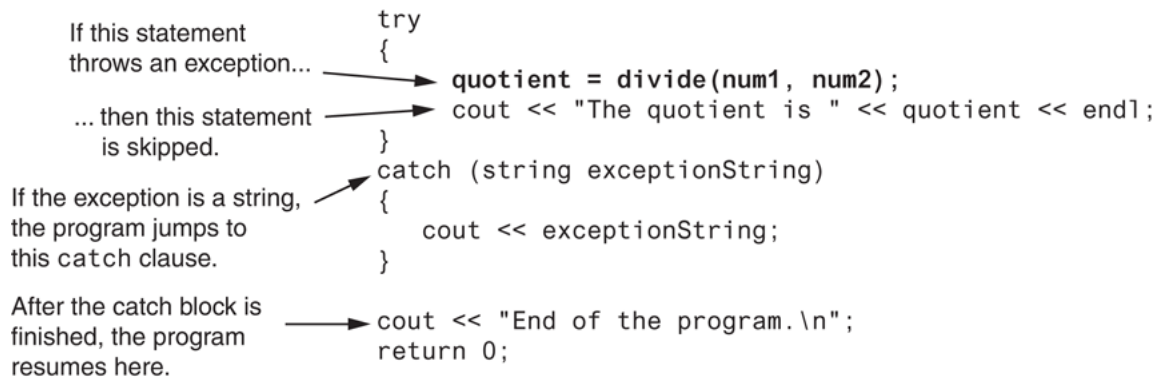
```
Enter two numbers: 12 2 Enter
The quotient is 6
End of the program.
```

### Program Output with Different Example Input Shown in Bold

```
Enter two numbers: 12 0 Enter
ERROR: Cannot divide by zero.
End of the program.
```

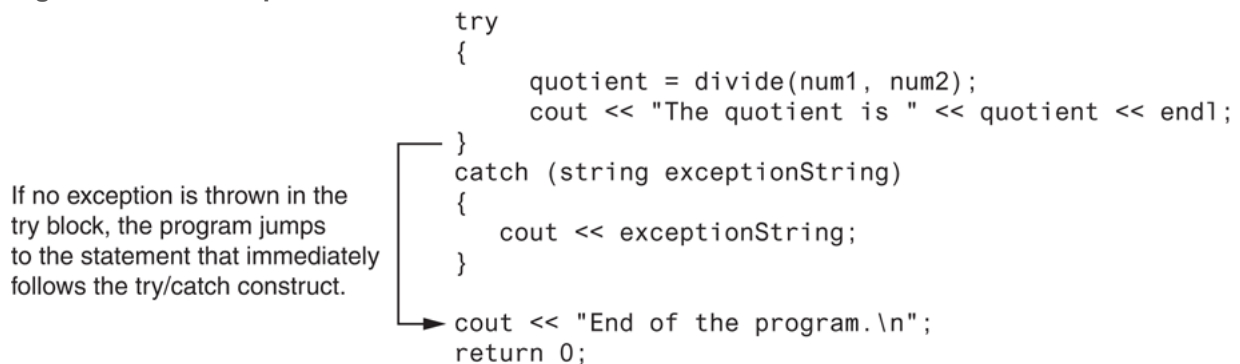
As you can see from the second output screen, the exception caused the program to jump out of the `divide` function and into the catch block. After the catch block has finished, the program resumes with the first statement after the try/catch construct. This is illustrated in [Figure 16-1](#) .

**Figure 16-1 How the try/catch construct works**



In the first output screen, the user entered nonnegative values. No exception was thrown in the try block, so the program skipped the catch block and jumped to the statement immediately following the try/catch construct, which is in line 30. This is illustrated in [Figure 16-2](#).

**Figure 16-2 No exception was thrown**



## What if an Exception Is Not Caught?

There are two possible ways for a thrown exception to go uncaught. The first possibility is for the try/catch construct to contain no catch blocks with an exception parameter of the right data type. The second possibility is for the exception to be thrown from outside a try block. In either case, the exception will cause the entire program to abort execution.

# Object-Oriented Exception Handling with Classes

Now that you have an idea of how the exception mechanism in C++ works, we will examine an object-oriented approach to exception handling. Recall the `Rectangle` class that was introduced in [Chapter 13](#). That class had the mutator functions `setWidth` and `setLength` for setting the rectangle's width and length. If a negative value was passed to either of these functions, the class displayed an error message and aborted the program. The following code shows an improved version of the `Rectangle` class. This version throws an exception when a negative value is passed to `setWidth` or `setLength`. (These files can be found in the Student Source Code Folder [Chapter 16](#)\Rectangle Version 1.)

## Contents of `Rectangle.h` (Version 1)

```
1 // Specification file for the Rectangle class
2 #ifndef RECTANGLE_H
3 #define RECTANGLE_H
4
5 class Rectangle
6 {
7     private:
8         double width;    // The rectangle's width
9         double length;   // The rectangle's length
10    public:
11        // Exception class
12        class NegativeSize
13            { };        // Empty class declaration
14
15        // Default constructor
16        Rectangle()
17            { width = 0.0; length = 0.0; }
18
19        // Mutator functions, defined in Rectangle.cpp
20        void setWidth(double);
21        void setLength(double);
22
23        // Accessor functions
24        double getWidth() const
25            { return width; }
26
27        double getLength() const
28            { return length; }
29
30        double getArea() const
31            { return width * length; }
32 };
33 #endif
```

Notice the empty class declaration that appears in the public section, in lines 12 and 13. The `NegativeSize` class has no members. The only important part of the class is its name, which will be used in the exception-handling code. Now look at the `Rectangle.cpp` file, where the `setWidth` and `setLength` member functions are defined.

## Contents of `Rectangle.cpp` (Version 1)

```
1 // Implementation file for the Rectangle class.
2 #include "Rectangle.h"
3
4 //*****
5 // setWidth sets the value of the member variable width. *
6 //*****
7
8 void Rectangle::setWidth(double w)
9 {
10     if (w >= 0)
11         width = w;
12     else
13         throw NegativeSize();
14 }
15
16 //*****
17 // setLength sets the value of the member variable length. *
18 //*****
19
20 void Rectangle::setLength(double len)
21 {
22     if (len >= 0)
23         length = len;
24     else
25         throw NegativeSize();
26 }
```



In the `setWidth` function, the parameter `w` is tested by the `if` statement in line 10. If `w` is greater than or equal to 0, its value is assigned to the `width` member variable. If `w` holds a negative number,

however, the statement in line 13 is executed.

```
throw NegativeSize();
```

The `throw` statement's argument, `NegativeSize()`, causes an instance of the `NegativeSize` class to be created and thrown as an exception.

The same series of events takes place in the `setLength` function. If the value in the `len` parameter is greater than or equal to 0, its value is assigned to the `length` member variable. If `len` holds a negative number, an instance of the `NegativeSize` class is thrown as an exception in line 25.

This way of reporting errors is much more graceful than simply aborting the program. Any code that uses the `Rectangle` class must simply have a catch block to handle the `NegativeSize` exceptions that the `Rectangle` class might throw. **Program 16-2**  shows an example. (This file can be found in the Student Source Code Folder **Chapter 16**  \Rectangle Version 1.)

## Program 16-2

```
1 // This program demonstrates Rectangle class exceptions.
2 #include <iostream>
3 #include "Rectangle.h"
4 using namespace std;
5
6 int main()
7 {
8     double width;
9     double length;
10
11     // Create a Rectangle object.
12     Rectangle myRectangle;
13
14     // Get the width and length.
15     cout << "Enter the rectangle's width: ";
16     cin >> width;
17     cout << "Enter the rectangle's length: ";
18     cin >> length;
19
20     // Store these values in the Rectangle object.
21     try
22     {
23         myRectangle.setWidth(width);
24         myRectangle.setLength(length);
25         cout << "The area of the rectangle is "
26             << myRectangle.getArea() << endl;
27     }
28     catch (Rectangle::NegativeSize)
29     {
30         cout << "Error: A negative value was entered.\n";
31     }
32     cout << "End of the program.\n";
33
34     return 0;
35 }
```



### Program Output with Example Input Shown in Bold

```
Enter the rectangle's width: 10 Enter
Enter the rectangle's length: 20 Enter
The area of the rectangle is 200
End of the program.
```

### Program Output with Different Example Input Shown in Bold

```
Enter the rectangle's width: 5 Enter
Enter the rectangle's length: -5 Enter
Error: A negative value was entered.
End of the program.
```

The `catch` statement in line 28 catches the `NegativeSize` exception when it is thrown by any of the statements in the try block. Inside the `catch` statement's parentheses is the name of the `NegativeSize` class. Because the `NegativeSize` class is declared inside the `Rectangle` class, we have to fully qualify the class name with the scope resolution operator.

Notice we did not define a parameter of the `NegativeSize` class in the `catch` statement. In this case, the `catch` statement only needs to specify the type of exception it handles.

# Multiple Exceptions

The programs we have studied so far test only for a single type of error and throw only a single type of exception. In many cases, a program will need to test for several different types of errors and signal which one has occurred. C++ allows you to throw and catch multiple exceptions. The only requirement is that each different exception be of a different type. You then code a separate catch block for each type of exception that may be thrown in the try block.

For example, suppose we wish to expand the `Rectangle` class so it throws one type of exception when a negative value is specified for the `width`, and another type of exception when a negative value is specified for the `length`. First, we declare two different exception classes, such as:

```
// Exception class for a negative width
class NegativeWidth
{
};

// Exception class for a negative length
class NegativeLength
{
};
```

An instance of `NegativeWidth` will be thrown when a negative value is specified for the `width`, and an instance of `NegativeLength` will be thrown when a negative value is specified for the `length`. The code for the modified `Rectangle` class is shown here. (These files can be found in the Student Source Code Folder [Chapter 16](#) \Rectangle Version 2.)

## Contents of `Rectangle.h` (Version 2)

```
1 // Specification file for the Rectangle class
2 #ifndef RECTANGLE_H
3 #define RECTANGLE_H
4
5 class Rectangle
6 {
7     private:
8         double width;    // The rectangle's width
9         double length;   // The rectangle's length
10    public:
11        // Exception class for a negative width
12        class NegativeWidth
13        { };
14
15        // Exception class for a negative length
16        class NegativeLength
17        { };
18
19        // Default constructor
20        Rectangle()
21        { width = 0.0; length = 0.0; }
22
23        // Mutator functions, defined in Rectangle.cpp
24        void setWidth(double);
25        void setLength(double);
26
27        // Accessor functions
28        double getWidth() const
29        { return width; }
30
31        double getLength() const
32        { return length; }
33
34        double getArea() const
35        { return width * length; }
```

```
36 };
37 #endif
```

## Contents of `Rectangle.cpp` (Version 2)

```
1 // Implementation file for the Rectangle class.
2 #include "Rectangle.h"
3
4 //*****
5 // setWidth sets the value of the member variable width. *
6 //*****
7
8 void Rectangle::setWidth(double w)
9 {
10     if (w >= 0)
11         width = w;
12     else
13         throw NegativeWidth();
14 }
15
16 //*****
17 // setLength sets the value of the member variable length. *
18 //*****
19
20 void Rectangle::setLength(double len)
21 {
22     if (len >= 0)
23         length = len;
24     else
25         throw NegativeLength();
26 }
```

Notice in the definition of the `setWidth` function (in `Rectangle.cpp`) that an instance of the `NegativeWidth` class is thrown in line 13. In the definition of the `setLength` function, an instance of the

`NegativeLength` class is thrown in line 25. [Program 16-3](#) demonstrates this class. (This file can be found in the Student Source Code Folder [Chapter 16](#)\Rectangle Version 2.)

## Program 16-3

```
1 // This program demonstrates Rectangle class exceptions.
2 #include <iostream>
3 #include "Rectangle.h"
4 using namespace std;
5
6 int main()
7 {
8     double width;
9     double length;
10
11     // Create a Rectangle object.
12     Rectangle myRectangle;
13
14     // Get the width and length.
15     cout << "Enter the rectangle's width: ";
16     cin >> width;
17     cout << "Enter the rectangle's length: ";
18     cin >> length;
19
20     // Store these values in the Rectangle object.
21     try
22     {
23         myRectangle.setWidth(width);
24         myRectangle.setLength(length);
25         cout << "The area of the rectangle is "
26             << myRectangle.getArea() << endl;
27     }
28     catch (Rectangle::NegativeWidth)
29     {
30         cout << "Error: A negative value was given "
31             << "for the rectangle's width.\n";
32     }
33     catch (Rectangle::NegativeLength)
34     {
35         cout << "Error: A negative value was given "
36             << "for the rectangle's length.\n";
37     }
```

```
38
39     cout << "End of the program.\n";
40     return 0;
41 }
```

### Program Output with Example Input Shown in Bold

```
Enter the rectangle's width: 10 Enter
Enter the rectangle's length: 20 Enter
The area of the rectangle is 200
End of the program.
```

### Program Output with Different Example Input Shown in Bold

```
Enter the rectangle's width: -5 Enter
Enter the rectangle's length: 5 Enter
Error: A negative value was given for the rectangle's width.
End of the program.
```




### Program Output with Different Example Input Shown in Bold

```
Enter the rectangle's width: 5 Enter
Enter the rectangle's length: -5 Enter
Error: A negative value was given for the rectangle's length.
End of the program.
```

The try block, in lines 21 through 27, contains code that can throw two different types of exceptions. The statement in line 23 can potentially throw a `NegativeWidth` exception, and the statement in line 24 can potentially throw a `NegativeLength` exception. To handle each of these types of exception, there are two `catch` statements. The statement in line 28 catches `NegativeWidth` exceptions, and the statement in line 33 catches `NegativeLength` exceptions.

When an exception is thrown by code in the try block, C++ searches the try/catch construct for a `catch` statement that can handle the exception. If the construct contains a `catch` statement that is compatible with the exception, control of the program is passed to the catch block.

## *Using Exception Handlers to Recover from Errors*

**Program 16-3**  demonstrates how a try/catch construct can have several `catch` statements in order to handle different types of exceptions. However, the program does not use the exception handlers to recover from any of the errors. When the user enters a negative value for either the width or the length, this program still halts. **Program 16-4**  shows a better example of effective exception handling. It attempts to recover from the exceptions and get valid data from the user. (This file can be found in the Student Source Code Folder **Chapter 16**  \Rectangle Version 2.)



## Program 16-4

```
1 // This program handles the Rectangle class exceptions.
2 #include <iostream>
3 #include "Rectangle.h"
4 using namespace std;
5
6 int main()
7 {
8     double width;           // Rectangle's width
9     double length;         // Rectangle's length
10    bool tryAgain = true;   // Flag to reread input
11
12    // Create a Rectangle object.
13    Rectangle myRectangle;
14
15    // Get the rectangle's width.
16    cout << "Enter the rectangle's width: ";
17    cin >> width;
18
19    // Store the width in the myRectangle object.
20    while (tryAgain)
21    {
22        try
23        {
24            myRectangle.setWidth(width);
25            // If no exception was thrown, then the
26            // next statement will execute.
27            tryAgain = false;
28        }
29        catch (Rectangle::NegativeWidth)
30        {
31            cout << "Please enter a nonnegative value: ";
32            cin >> width;
33        }
34    }
35
36    // Get the rectangle's length.
37    cout << "Enter the rectangle's length: ";
```

```

38     cin >> length;
39
40     // Store the length in the myRectangle object.
41     tryAgain = true;
42     while (tryAgain)
43     {
44         try
45         {
46             myRectangle.setLength(length);
47             // If no exception was thrown, then the
48             // next statement will execute.
49             tryAgain = false;
50         }
51         catch (Rectangle::NegativeLength)
52         {
53             cout << "Please enter a nonnegative value: ";
54             cin >> length;
55         }
56     }
57
58     // Display the area of the rectangle.
59     cout << "The rectangle's area is "
60         << myRectangle.getArea() << endl;
61     return 0;
62 }

```

### Program Output with Example Input Shown in Bold

```

Enter the rectangle's width: -1 Enter
Please enter a nonnegative value: 10 Enter
Enter the rectangle's length: -5 Enter
Please enter a nonnegative value: 50 Enter
The rectangle's area is 500

```

Let's look at how this program recovers from a `NegativeWidth` exception. In line 10, a `bool` flag variable, `tryAgain`, is defined and initialized with the value `true`. This variable will indicate whether we need to get a value from the user again. Lines 16 and 17 prompt the user to enter the rectangle's width.

Then, the program enters the `while` loop in lines 20 through 34. The loop repeats as long as `tryAgain` is `true`. Inside the loop, the `Rectangle` class's `setWidth` member function is called in line 24. This statement is in a try block. If a `NegativeWidth` exception is thrown, the program will jump to the `catch` statement in line 29. In the `catch` block that follows, the user is asked to enter a nonnegative number. The program then jumps out of the try/catch construct. Because `tryAgain` is still `true`, the loop will repeat.

If a nonnegative number is passed to the `setWidth` member function in line 24, no exception will be thrown. In that case, the statement in line 27 will execute, which sets `tryAgain` to `false`. The program then jumps out of the try/catch construct. Because `tryAgain` is now `false`, the loop will not repeat.

The same strategy is used in lines 37 through 56 to get and validate the rectangle's length.

# Extracting Data from the Exception Class

Sometimes we might want an exception object to pass data back to the exception handler. For example, suppose we would like the `Rectangle` class not only to signal when a negative value has been given, but also to pass the value back. This can be accomplished by giving the exception class members in which data can be stored.

In our next modification of the `Rectangle` class, the `NegativeWidth` and `NegativeLength` classes have been expanded, each with a member variable and a constructor. Here is the code for the `NegativeWidth` class:

```
class NegativeWidth
{
private:
    double value;
public:
    NegativeWidth(double val)
        { value = val; }
    double getValue() const
        { return value; }
};
```

When we throw this exception, we want to pass the invalid value as an argument to the class's constructor. This is done in the `setWidth` member function with the following statement:

```
throw NegativeWidth(w);
```

This `throw` statement creates an instance of the `NegativeWidth` class and passes a copy of the `w` variable to the constructor. The constructor then stores this number in `NegativeWidth`'s member variable, `value`. The class instance carries this member variable to the catch block that intercepts the exception.

In the catch block, the value is extracted with code such as

```

catch (Rectangle::NegativeWidth e)
{
    cout << "Error: " << e.getValue()
        << " is an invalid value for the"
        << " rectangle's width.\n";
}

```

Notice the catch block defines a parameter object named `e`. This is necessary because we want to call the class's `getValue` function to retrieve the value that caused the exception.

Here is the code for the `NegativeLength` class:

```

class NegativeLength
{
private:
    double value;
public:
    NegativeLength(double val)
        { value = val; }
    double getValue() const
        { return value; }
};

```

This class also has a member variable named `value`, and a constructor that initializes the variable. When we throw this exception, we follow the same general steps that were just described for the `NegativeWidth` exception. The complete code for the revised `Rectangle` class is shown here. **Program 16-5** [□](#) demonstrates these classes. (These files can be found in the Student Source Code Folder **Chapter 16** [□](#)\Rectangle Version 3.)

## Contents of `Rectangle.h` (Version 3)

```
1 // Specification file for the Rectangle class
2 #ifndef RECTANGLE_H
3 #define RECTANGLE_H
4
5 class Rectangle
6 {
7     private:
8         double width;    // The rectangle's width
9         double length;   // The rectangle's length
10    public:
11        // Exception class for a negative width
12        class NegativeWidth
13        {
14            private:
15                double value;
16            public:
17                NegativeWidth(double val)
18                    { value = val; }
19
20                double getValue() const
21                    { return value; }
22        };
23
24        // Exception class for a negative length
25        class NegativeLength
26        {
27            private:
28                double value;
29            public:
30                NegativeLength(double val)
31                    { value = val; }
32
33                double getValue() const
34                    { return value; }
35        };
36
37        // Default constructor
```

```
38     Rectangle()
39         { width = 0.0; length = 0.0; }
40
41     // Mutator functions, defined in Rectangle.cpp
42     void setWidth(double);
43     void setLength(double);
44
45     // Accessor functions
46     double getWidth() const
47         { return width; }
48
49     double getLength() const
50         { return length; }
51
52     double getArea() const
53         { return width * length; }
54 };
55 #endif
```

## Contents of `Rectangle.cpp` (Version 3)

```
1 // Implementation file for the Rectangle class.
2 #include "Rectangle.h"
3
4 //*****
5 // setWidth sets the value of the member variable width. *
6 //*****
7
8 void Rectangle::setWidth(double w)
9 {
10     if (w >= 0)
11         width = w;
12     else
13         throw NegativeWidth(w);
14 }
15
16 //*****
17 // setLength sets the value of the member variable length. *
18 //*****
19
20 void Rectangle::setLength(double len)
21 {
22     if (len >= 0)
23         length = len;
24     else
25         throw NegativeLength(len);
26 }
```



## Program 16-5

```
1 // This program demonstrates Rectangle class exceptions.
2 #include <iostream>
3 #include "Rectangle.h"
4 using namespace std;
5
6 int main()
7 {
8     double width;
9     double length;
10
11     // Create a Rectangle object.
12     Rectangle myRectangle;
13
14     // Get the width and length.
15     cout << "Enter the rectangle's width: ";
16     cin >> width;
17     cout << "Enter the rectangle's length: ";
18     cin >> length;
19
20     // Store these values in the Rectangle object.
21     try
22     {
23         myRectangle.setWidth(width);
24         myRectangle.setLength(length);
25         cout << "The area of the rectangle is "
26             << myRectangle.getArea() << endl;
27     }
28     catch (Rectangle::NegativeWidth e)
29     {
30         cout << "Error: " << e.getValue()
31             << " is an invalid value for the"
32             << " rectangle's width.\n";
33     }
34     catch (Rectangle::NegativeLength e)
35     {
36         cout << "Error: " << e.getValue()
37             << " is an invalid value for the"
```

```
38     cout << " rectangle's length.\n";
39 }
40
41     cout << "End of the program.\n";
42     return 0;
43 }
```

### Program Output with Example Input Shown in Bold

```
Enter the rectangle's width: -1 Enter
Enter the rectangle's length: 10 Enter
Error: -1 is an invalid value for the rectangle's width.
End of the program.
```

### Program Output with Different Example Input Shown in Bold

```
Enter the rectangle's width: 5 Enter
Enter the rectangle's length: -1 Enter
Error: -1 is an invalid value for the rectangle's length.
End of the program.
```

## Unwinding the Stack

Once an exception has been thrown, the program cannot jump back to the throw point. The function that executes a `throw` statement will immediately terminate. If that function was called by another function, and the exception is not caught, then the calling function will terminate as well. This process, known as *unwinding the stack*, continues for the entire chain of nested function calls, from the throw point, all the way back to the try block.

If an exception is thrown by the member function of a class object, then the class destructor is called. If statements in the try block (or statements branching from the try block) created any other objects, their destructors will be called as well.

# Rethrowing an Exception

It is possible for try blocks to be nested. For example, look at this code segment:

```
try
{
    doSomething();
}
catch(exception1)
{
    // code to handle exception 1
}
catch(exception2)
{
    // code to handle exception 2
}
```

In this try block, the function `doSomething` is called. There are two catch blocks, one that handles `exception1`, and another that handles `exception2`. If the `doSomething` function also has a try block, then it is nested inside the one shown.

With nested try blocks, it is sometimes necessary for an inner exception handler to pass an exception to an outer exception handler. Sometimes both an inner and an outer catch block must perform operations when a particular exception is thrown. These situations require that the inner catch block *rethrow* the exception so the outer catch block has a chance to catch it.

A catch block can rethrow an exception with the `throw` statement. For example, suppose the `doSomething` function (called in the throw block above) calls the `doSomethingElse` function, which potentially can throw `exception1` or `exception3`. Suppose `doSomething` does not want to handle `exception1`. Instead, it wants to rethrow it to the outer block. The following code segment illustrates how this is done:

```
try
{
    doSomethingElse();
}
catch(exception1)
{
    throw; // Rethrow the exception
}
catch(exception3)
{
    // Code to handle exception 3
}
```

When the first catch block catches `exception1`, the `throw` statement simply throws the exception again. The catch block in the outer try/catch construct will then handle the exception.

# Handling the `bad_alloc` Exception

Recall from [Chapter 9](#) that when the `new` operator fails to allocate memory, an exception is thrown. Now that you've seen how to handle exceptions, you can write code that determines whether the `new` operator was successful.

When the `new` operator fails to allocate memory, C++ throws a `bad_alloc` exception. The `bad_alloc` exception type is defined in the `<new>` header file, so any program that attempts to catch this exception should have the following directive:

```
#include <new>
```

The `bad_alloc` exception is in the `std` namespace, so be sure to have the `using namespace std;` statement in your code as well.

Here is the general format of a try/catch construct that catches the `bad_alloc` exception:

```
try
{
    // Code that uses the new operator
}
catch (bad_alloc)
{
    // Code that responds to the error
}
```

**Program 16-6** shows an example. The program uses the `new` operator to allocate a 10,000- element array of `double`s. If the `new` operator fails, an error message is displayed.

## Program 16-6

```
1 // This program demonstrates the bad_alloc exception.
2 #include <iostream>
3 #include <new> // Needed for bad_alloc
4 using namespace std;
5
6 int main()
7 {
8     double *ptr = nullptr; // Pointer to double
9
10    try
11    {
12        ptr = new double [10000];
13    }
14    catch (bad_alloc)
15    {
16        cout << "Insufficient memory.\n";
17    }
18
19    return 0;
20 }
```

### Checkpoint

- 16.1 What is the difference between a try block and a catch block?
- 16.2 What happens if an exception is thrown, but not caught?
- 16.3 If multiple exceptions can be thrown, how does the catch block know which exception to catch?
- 16.4 After the catch block has handled the exception, where does program execution resume?
- 16.5 How can an exception pass data back to the exception handler?

## 16.2 Function Templates

**Concept:**

A function template is a “generic” function that can work with any data type. The programmer writes the specifications of the function, but substitutes parameters for data types. When the compiler encounters a call to the function, it generates code to handle the specific data type(s) used in the call.

# Introduction

Overloaded functions make programming convenient because only one function name must be remembered for a set of functions that perform similar operations. Each of the functions, however, must still be written individually, even if they perform the same operation. For example, suppose a program uses the following overloaded `square` functions:

```
int square(int number)
{
    return number * number;
}
double square(double number)
{
    return number * number;
}
```

The only differences between these two functions are the data types of their return values and their parameters. In situations like this, it is more convenient to write a *function template* than an overloaded function. Function templates allow you to write a single function definition that works with many different data types, instead of having to write a separate function for each data type used.

A function template is not an actual function, but a “mold” the compiler uses to generate one or more functions. When writing a function template, you do not have to specify actual types for the parameters, return value, or local variables. Instead, you use a *type parameter* to specify a generic data type. When the compiler encounters a call to the function, it examines the data types of its arguments and generates the function code that will work with those data types. (The generated code is known as a *template function*.)

Here is a function template for the `square` function:

```
template <class T>
T square(T number)
{
    return number * number;
}
```





## Writing a Function Template

The beginning of a function template is marked by a *template prefix*, which begins with the key word `template`. Next is a set of angled brackets that contains one or more generic data types used in the template. A generic data type starts with the key word `class` followed by a parameter name that stands for the data type. The example just given only uses one, which is named `T`. (If there were more, they would be separated by commas.) After this, the function definition is written as usual, except the type parameters are substituted for the actual data type names. In the example, the function header reads

```
T square(T number)
```

`T` is the type parameter, or generic data type. The header defines `square` as a function that returns a value of type `T` and uses a parameter, `number`, which is also of type `T`. As mentioned before, the compiler examines each call to `square` and fills in the appropriate data type for `T`. For example, the following call uses an `int` argument:

```
int y, x = 4;  
y = square(x);
```

This code will cause the compiler to generate the function


```
int square(int number)  
{  
    return number * number;  
}
```

while the following statements

```
double y, f = 6.2  
y = square(f);
```

will generate the function

```
double square(double number)
{
    return number * number;
}
```

**Program 16-7**  demonstrates how this function template is used.

## Program 16-7

```
1 // This program uses a function template.
2 #include <iostream>
3 #include <iomanip>
4 using namespace std;
5
6 // Template definition for square function.
7 template <class T>
8 T square(T number)
9 {
10     return number * number;
11 }
12
13 int main()
14 {
15     int userInt; // To hold integer input
16     double userDouble; // To hold double input
17
18     cout << setprecision(5);
19     cout << "Enter an integer and a floating-point value: ";
20     cin >> userInt >> userDouble;
21     cout << "Here are their squares: ";
22     cout << square(userInt) << " and "
23         << square(userDouble) << endl;
24     return 0;
25 }
```

### Program Output with Example Input Shown in Bold

```
Enter an integer and a floating-point value: 12 4.2 Enter
Here are their squares: 144 and 17.64
```

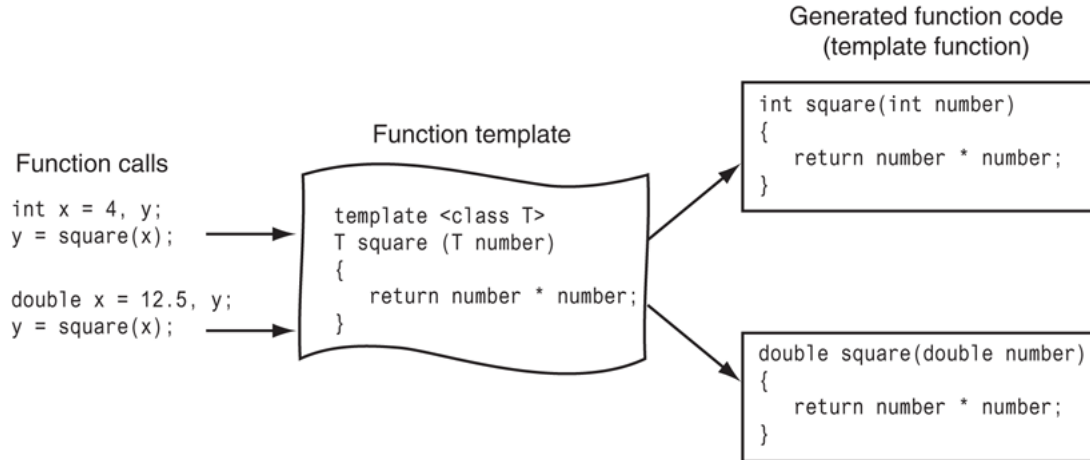


### Note:

All type parameters defined in a function template must appear at least once in the function parameter list.

Because the compiler encountered two calls to `square` in [Program 16-7](#), each with a different parameter type, it generated the code for two instances of the function: one with an `int` parameter and `int` return type, the other with a `double` parameter and `double` return type. This is illustrated in [Figure 16-3](#).

Figure 16-3 Generation of template functions




Notice in [Program 16-7](#) that the template appears before all calls to `square`. As with regular functions, the compiler must already know the template's contents when it encounters a call to the template function. Templates, therefore, should be placed near the top of the program or in a header file.



### Note:

A function template is merely the specification of a function and by itself does not cause memory to be used. An actual instance of the function is created in memory when the compiler encounters a call to the template function.

**Program 16-8**  shows another example of a function template. The function, `swapVars`, uses two references to type `T` as parameters. The function swaps the contents of the variables referenced by the parameters.

## Program 16-8

```
1 // This program demonstrates the swapVars function template.
2 #include <iostream>
3 using namespace std;
4
5 template <class T>
6 void swapVars(T &var1, T &var2)
7 {
8     T temp;
9
10    temp = var1;
11    var1 = var2;
12    var2 = temp;
13 }
14
15 int main()
16 {
17     char firstChar, secondChar; // Two chars
18     int firstInt, secondInt; // Two ints
19     double firstDouble, secondDouble; // Two doubles
20
21     // Get and swapVars two chars
22     cout << "Enter two characters: ";
23     cin >> firstChar >> secondChar;
24     swapVars(firstChar, secondChar);
25     cout << firstChar << " " << secondChar << endl;
26
27     // Get and swapVars two ints
28     cout << "Enter two integers: ";
29     cin >> firstInt >> secondInt;
30     swapVars(firstInt, secondInt);
31     cout << firstInt << " " << secondInt << endl;
32
33     // Get and swapVars two doubles
34     cout << "Enter two floating-point numbers: ";
35     cin >> firstDouble >> secondDouble;
36     swapVars(firstDouble, secondDouble);
37     cout << firstDouble << " " << secondDouble << endl;
```

```
38     return 0;  
39 }
```

### Program Output with Example Input Shown in Bold

```
Enter two characters: A B Enter  
B A  
Enter two integers: 5 10 Enter  
10 5  
Enter two floating-point numbers: 1.2 9.6 Enter  
9.6 1.2
```

## Using Operators in Function Templates

The `square` template shown earlier uses the `*` operator with the `number` parameter. This works well as long as `number` is of a primitive data type such as `int`, `float`, and so on. If a user-defined class object is passed to the `square` function, however, the class must contain code for an overloaded `*` operator. If not, the compiler will generate a function with an error.

Always remember a class object passed to a function template must support all the operations the function will perform on the object. For instance, if the function performs a comparison on the object (with `>`, `<`, `==`, or another relational operator), those operators must be overloaded by the class object.

# Function Templates with Multiple Types

More than one generic type may be used in a function template. Each type must have its own parameter, as shown in [Program 16-9](#). This program uses a function template named `larger`. This template uses two type parameters: `T1` and `T2`. The sizes of the function parameters, `var1` and `var2`, are compared, and the function returns the number of bytes occupied by the larger of the two. Because the function parameters are specified with different types, the function generated from this template can accept two arguments of different types.



## Program 16-9

```
1 // This program demonstrates a function template
2 // with two type parameters.
3 #include <iostream>
4 using namespace std;
5
6 template <class T1, class T2>
7 int largest(const T1 &var1, T2 &var2)
8 {
9     if (sizeof(var1) > sizeof(var2))
10        return sizeof(var1);
11     else
12        return sizeof(var2);
13 }
14
15 int main()
16 {
17     int i = 0;
18     char c = ' ';
19     float f = 0.0;
20     double d = 0.0;
21
22     cout << "Comparing an int and a double, the largest\n"
23          << "of the two is " << largest(i, d) << " bytes.\n";
24
25     cout << "Comparing a char and a float, the largest\n"
26          << "of the two is " << largest(c, f) << " bytes.\n";
27
28     return 0;
29 }
```

## Program Output

Comparing an int and a double, the largest of the two is 8 bytes.

Comparing a char and a float, the largest of the two is 4 bytes.



**Note:**

Each type parameter declared in the template prefix must be used somewhere in the template definition.

# Overloading with Function Templates

Function templates may be overloaded. As with regular functions, function templates are overloaded by having different parameter lists. For example, there are two overloaded versions of the `sum` function in [Program 16-10](#). The first version accepts two arguments, and the second version accepts three.

## Program 16-10

```
1 // This program demonstrates an overloaded function template.
2 #include <iostream>
3 using namespace std;
4
5 template <class T>
6 T sum(T val1, T val2)
7 {
8     return val1 + val2;
9 }
10
11 template <class T>
12 T sum(T val1, T val2, T val3)
13 {
14     return val1 + val2 + val3;
15 }
16
17 int main()
18 {
19     double num1, num2, num3;
20
21     // Get two values and display their sum.
22     cout << "Enter two values: ";
23     cin >> num1 >> num2;
24     cout << "Their sum is " << sum(num1, num2) << endl;
25
26     // Get three values and display their sum.
27     cout << "Enter three values: ";
28     cin >> num1 >> num2 >> num3;
29     cout << "Their sum is " << sum(num1, num2, num3) << endl;
30     return 0;
31 }
```


**Program Output with Example Input Shown in Bold**

```
Enter two values: 12.5 6.9 Enter
Their sum is 19.4

Enter three values: 45.76 98.32 10.51 Enter
Their sum is 154.59
```

There are other ways to perform overloading with function templates as well. For example, a program might contain a regular (nontemplate) version of a function as well as a template version. As long as each has a different parameter list, they can coexist as overloaded functions.

## 16.3 Focus on Software Engineering: Where to Start When Defining Templates

Quite often, it is easier to convert an existing function into a template than to write a template from scratch. With this in mind, you should start designing a function template by writing it first as a regular function. For example, the `swapVars` template in [Program 16-8](#)  would have been started as something like the following:

```
void swapVars(int &var1, int &var2)
{
    int temp;
    temp = var1;
    var1 = var2;
    var2 = temp;
}
```

Once this function is properly tested and debugged, converting it to a template is a simple process. First, the `template <class T>` header is added, then all the references to `int` that must be changed are replaced with the data type parameter `T`.

# Checkpoint

16.6 When does the compiler actually generate code for a function template?

16.7 The following function accepts an `int` argument and returns half of its value as a `double`:

```
double half(int number)
{
    return number / 2.0;
}
```

Write a template that will implement this function to accept an argument of any type.

16.8 What must you be sure of when passing a class object to a function template that uses an operator, such as `*` or `>`?

16.9 What is the best method for writing a function template?

## 16.4 Class Templates

### Concept:

Templates may also be used to create generic classes and abstract data types. Class templates allow you to create one general version of a class without having to duplicate code to handle multiple data types.

Recall the `IntArray` class from [Chapter 14](#). By overloading the `[]` operator, this class allows you to implement `int` arrays that perform bounds checking. But suppose you would like to have a version of this class for other data types. Of course, you could design specialized classes such as `LongArray`, `FloatArray`, `DoubleArray`, and so forth. A better solution, however, is to design a single class template that works with any primitive data type. In this section, we will convert the `IntArray` class into a generalized template named `SimpleVector`.

Declaring a class template is very similar to declaring a function template. First, a template prefix, such as `template <class T>`, is placed before the class declaration. As with function templates, `T` (or



whatever identifier you choose to use) is a data type parameter. Then, throughout the class declaration, the data type parameter is used where you wish to support any data type. Below is the `SimpleVector` class template declaration.

## Contents of `SimpleVector.h`

```
1 // SimpleVector class template
2 #ifndef SIMPLEVECTOR_H
3 #define SIMPLEVECTOR_H
4 #include <iostream>
5 #include <new> // Needed for bad_alloc
exception
6 #include <cstdlib> // Needed for the exit
function
7 using namespace std;
8
9 template <class T>
10 class SimpleVector
11 {
12 private:
13     T *aptr; // To point to the
allocated array
14     int arraySize; // Number of elements in
the array
15     void memError(); // Handles memory
allocation errors
16     void subError(); // Handles subscripts
out of range
17
```

```
18 public:
19     // Default constructor
20     SimpleVector()
21     { aptr = 0; arraySize = 0;}
22
23     // Constructor declaration
24     SimpleVector(int);
25
26     // Copy constructor declaration
27     SimpleVector(const SimpleVector &);
28
29     // Destructor declaration
30     ~SimpleVector();
31
32     // Accessor to return the array size
33     int size() const
34     { return arraySize; }
35
36     // Accessor to return a specific element
37     T getElementAt(int position);
38
39     // Overloaded [] operator declaration
40     T &operator[](const int &);
41 };
42
43
44 //*****
```

```

*****
44 // Constructor for SimpleVector class. Sets
the size of the *
45 // array and allocates memory for it.
*
46
//*****
*****
47
48 template <class T>
49 SimpleVector<T>::SimpleVector(int s)
50 {
51     arraySize = s;
52     // Allocate memory for the array.
53     try
54     {
55         aptr = new T [s];
56     }
57     catch (bad_alloc)
58     {
59         memError();
60     }
61
62     // Initialize the array.
63     for (int count = 0; count < arraySize;
count++)
64         *(aptr + count) = 0;

```

```

65 }
66
67 //*****
68 // Copy Constructor for SimpleVector class. *
69 //*****
70
71 template <class T>
72 SimpleVector<T>::SimpleVector(const
SimpleVector &obj)
73 {
74     // Copy the array size.
75     arraySize = obj.arraySize;
76
77     // Allocate memory for the array.
78     aptr = new T [arraySize];
79     if (aptr == 0)
80         memError();
81
82     // Copy the elements of obj's array.
83     for(int count = 0; count < arraySize;
count++)
84         *(aptr + count) = *(obj.aptr +
count);
85 }
86
87 //*****
88 // Destructor for SimpleVector class. *

```

```

89  //*****
90
91  template <class T>
92  SimpleVector<T>::~~SimpleVector()
93  {
94      if (arraySize > 0)
95          delete [] aptr;
96  }
97
98
//*****
*****
99  // memError function. Displays an error
message and *
100 // terminates the program when memory
allocation fails. *
101
//*****
*****
102
103 template <class T>
104 void SimpleVector<T>::memError()
105 {
106     cout << "ERROR:Cannot allocate
memory.\n";
107     exit(EXIT_FAILURE);
108 }

```

```

109
110
//*****
*****
111 // subError function. Displays an error
message and *
112 // terminates the program when a subscript is
out of range. *
113
//*****
*****
114
115 template <class T>
116 void SimpleVector<T>::subError()
117 {
118     cout << "ERROR: Subscript out of
range.\n";
119     exit(EXIT_FAILURE);
120 }
121
122
//*****
*****
123 // getElementAt function. The argument is a
subscript. *
124 // This function returns the value stored at
the *

```

```

125 // subscript in the array.
*
126
//*****
*****
127
128 template <class T>
129 T SimpleVector<T>::getElementAt(int sub)
130 {
131     if (sub < 0 || sub >= arraySize)
132         subError();
133     return aptr[sub];
134 }
135
136
//*****
*****
137 // Overloaded [] operator. The argument is a
subscript. *
138 // This function returns a reference to the
element *
139 // in the array indexed by the subscript.
*
140
//*****
*****
141

```



```
142  template <class T>
143  T &SimpleVector<T>::operator[](const int
&sub)
144  {
145      if (sub < 0 || sub >= arraySize)
146          subError();
147      return aptr[sub];
148  }
149  #endif
```



## Note:


The `arraySize` member variable is declared as an `int`. This is because it holds the size of the array, which will be an integer value, regardless of the data type of the array. This is also why the `size` member function returns an `int`.

# Defining Objects of the Class Template

Class template objects are defined like objects of ordinary classes, with one small difference: the data type you wish to pass to the type parameter must be specified. Placing the data type name inside angled brackets immediately following the class name does this. For example, the following statements create two `SimpleVector` objects:

`intTable` and `doubleTable`.

```
SimpleVector<int> intTable(10);  
SimpleVector<double> doubleTable(10);
```

In the definition of `intTable`, the data type `int` will be used in the template everywhere the type parameter `T` appears. This will cause `intTable` to store an array of `int`s. Likewise, the definition of `doubleTable` passes the data type `double` into the parameter `T`, causing it to store an array of `double`s. This is demonstrated in [Program 16-11](#) .

## Program 16-11

```
1 // This program demonstrates the SimpleVector
template.
2 #include <iostream>
3 #include "SimpleVector.h"
4 using namespace std;
5
6 int main()
7 {
8     const int SIZE = 10; // Number of elements
9     int count;           // Loop counter
10
11     // Create a SimpleVector of ints.
12     SimpleVector<int> intTable(SIZE);
13
14     // Create a SimpleVector of doubles.
15     SimpleVector<double> doubleTable(SIZE);
16
17     // Store values in the two SimpleVectors.
18     for (count = 0; count < SIZE; count++)
19     {
20         intTable[count] = (count * 2);
21         doubleTable[count] = (count * 2.14);
22     }
```

```
23
24     // Display the values in the
SimpleVectors.
25     cout << "These values are in intTable:\n";
26     for (count = 0; count < SIZE; count++)
27         cout << intTable[count] << " ";
28     cout << endl;
29     cout << "These values are in
doubleTable:\n";
30     for (count = 0; count < SIZE; count++)
31         cout << doubleTable[count] << " ";
32     cout << endl;
33
34     // Use the standard + operator on the
elements.
35     cout << "\nAdding 5 to each element of
intTable"
36         << " and doubleTable.\n";
37     for (count = 0; count < SIZE; count++)
38     {
39         intTable[count] = intTable[count] + 5;
40         doubleTable[count] =
doubleTable[count] + 5.0;
41     }
42
43     // Display the values in the
SimpleVectors.
```

```
44     cout << "These values are in intTable:\n";
45     for (count = 0; count < SIZE; count++)
46         cout << intTable[count] << " ";
47     cout << endl;
48     cout << "These values are in
doubleTable:\n";
49     for (count = 0; count < SIZE; count++)
50         cout << doubleTable[count] << " ";
51     cout << endl;
52
53     // Use the standard ++ operator on the
elements.
54     cout << "\nIncrementing each element of
intTable and"
55         << " doubleTable.\n";
56     for (count = 0; count < SIZE; count++)
57     {
58         intTable[count]++;
59         doubleTable[count]++;
60     }
61
62     // Display the values in the
SimpleVectors.
63     cout << "These values are in intTable:\n";
64     for (count = 0; count < SIZE; count++)
65         cout << intTable[count] << " ";
66     cout << endl;
```

```
67     cout << "These values are in  
doubleTable:\n";  
68     for (count = 0; count < SIZE; count++)  
69         cout << doubleTable[count] << " ";  
70     cout << endl;  
71  
72     return 0;  
73 }
```

## Program Output

These values are in intTable:

0 2 4 6 8 10 12 14 16 18

These values are in doubleTable:

0 2.14 4.28 6.42 8.56 10.7 12.84 14.98 17.12  
19.26

Adding 5 to each element of intTable and  
doubleTable.

These values are in intTable:

5 7 9 11 13 15 17 19 21 23

These values are in doubleTable:

5 7.14 9.28 11.42 13.56 15.7 17.84 19.98  
22.12 24.26

Incrementing each element of intTable and  
doubleTable.

These values are in intTable:

6 8 10 12 14 16 18 20 22 24

These values are in doubleTable:

6 8.14 10.28 12.42 14.56 16.7 18.84 20.98  
23.12 25.26

# Class Templates and Inheritance

Inheritance can easily be applied to class templates. For example, in the following template, `SearchableVector` is derived from the `SimpleVector` class.



## Contents of `SearchableVector.h`

```
1  #ifndef SEARCHABLEVECTOR_H
2  #define SEARCHABLEVECTOR_H
3  #include "SimpleVector.h"
4
5  template <class T>
6  class SearchableVector : public
SimpleVector<T>
7  {
8  public:
9      // Default constructor
10     SearchableVector() : SimpleVector<T>()
11     { }
12
13     // Constructor
14     SearchableVector(int size) :
SimpleVector<T>(size)
15     { }
16
17     // Copy constructor
18     SearchableVector(const SearchableVector
&);
19
20     // Accessor to find an item
```

```

21     int findItem(const T);
22 };
23
24
//*****
*****
25 // Copy constructor
*
26
//*****
*****
27
28 template <class T>
29 SearchableVector<T>::SearchableVector(const
SearchableVector &obj) :
30     SimpleVector<T>(obj.size())
31 {
32     for(int count = 0; count < this->size();
count++)
33         this->operator[](count) = obj[count];
34 }
35
36
//*****
*****
37 // findItem function
*
```

```

38 // This function searches for item. If item is
found *
39 // the subscript is returned. Otherwise -1 is
returned.*
40
//*****
*****
41
42 template <class T>
43 int SearchableVector<T>::findItem(const T
item)
44 {
45     for (int count = 0; count <= this->size();
count++)
46     {
47         if (getElementAt(count) == item)
48             return count;
49     }
50     return -1;
51 }
52 #endif

```

This class template defines a searchable version of the `SimpleVector` class. The member function `findItem` accepts an argument and performs a simple linear search to determine whether

the argument's value is stored in the array. If the value is found in the array, its subscript is returned. Otherwise, `-1` is returned.


Notice each time the name `SimpleVector` is used in the class template, the type parameter `T` is used with it. For example, here is the first line of the class declaration, in line 6, which names `SimpleVector` as the base class:

```
class SearchableVector : public SimpleVector<T>
```

Also, here are the function headers for the class constructors:

```
SearchableVector() : SimpleVector<T>()  
SearchableVector(int size) : SimpleVector<T>(size)
```

Because `SimpleVector` is a class template, the type parameter must be passed to it.

**Program 16-12**  demonstrates the class by storing values in two `SearchableVector` objects, then searching for a specific value in each.

## Program 16-12

```
1 // This program demonstrates the
SearchableVector template.
2 #include <iostream>
3 #include "SearchableVector.h"
4 using namespace std;
5
6 int main()
7 {
8     const int SIZE = 10; // Number of elements
9     int count;           // Loop counter
10    int result;          // To hold search
results
11
12    // Create two SearchableVector objects.
13    SearchableVector<int> intTable(SIZE);
14    SearchableVector<double>
doubleTable(SIZE);
15
16    // Store values in the objects.
17    for (count = 0; count < SIZE; count++)
18    {
19        intTable[count] = (count * 2);
20        doubleTable[count] = (count * 2.14);
```

```
21     }
22
23     // Display the values in the objects.
24     cout << "These values are in intTable:\n";
25     for (count = 0; count < SIZE; count++)
26         cout << intTable[count] << " ";
27     cout << endl << endl;
28     cout << "These values are in
doubleTable:\n";
29     for (count = 0; count < SIZE; count++)
30         cout << doubleTable[count] << " ";
31     cout << endl;
32
33     // Search for the value 6 in intTable.
34     cout << "\nSearching for 6 in
intTable.\n";
35     result = intTable.findItem(6);
36     if (result == -1)
37         cout << "6 was not found in
intTable.\n";
38     else
39         cout << "6 was found at subscript " <<
result << endl;
40
41     // Search for the value 12.84 in
doubleTable.
42     cout << "\nSearching for 12.84 in
```

```
doubleTable.\n";  
43     result = doubleTable.findItem(12.84);  
44     if (result == -1)  
45         cout << "12.84 was not found in  
doubleTable.\n";  
46     else  
47         cout << "12.84 was found at subscript  
" << result << endl;  
48     return 0;  
49 }
```

## Program Output

```
These values are in intTable:
```

```
0 2 4 6 8 10 12 14 16 18
```

```
These values are in doubleTable:
```

```
0 2.14 4.28 6.42 8.56 10.7 12.84 14.98 17.12  
19.26
```

```
Searching for 6 in intTable.
```

```
6 was found at subscript 3
```

```
Searching for 12.84 in doubleTable.
```

```
12.84 was found at subscript 6
```

The `SearchableVector` class demonstrates that a class template may be derived from another class template. In addition, class templates may be derived from ordinary classes, and ordinary classes may be derived from class templates.



# Specialized Templates

Suppose you have a template that works for all data types but one. For example, the `SimpleVector` and `SearchableVector` classes work well with numeric data, and even character data. But they will not work with C-strings. Situations like this require the use of *specialized templates*. A specialized template is one that is designed to work with a specific data type. In the declaration, the actual data type is used instead of a type parameter. For example, the declaration of a specialized version of the `SimpleVector` class might start like this:

```
class SimpleVector<char *>
```

The compiler would know that this version of the `SimpleVector` class is intended for the `char *` data type. Anytime an object is defined of the type `SimpleVector <char *>`, the compiler will use this template to generate the code.



## Checkpoint

16.10 Suppose your program uses a class template named `List`, which is defined as

```
template<class T>
class List
{
    // Members are declared here...
};
```

Give an example of how you would use `int` as the data type in the definition of a `List` object. (Assume the class has a default constructor.)

16.11 As the following `Rectangle` class is written, the `width` and `length` members are `double`s. Rewrite the class as a template that will accept any data type for these members.

```
class Rectangle
{
    private:
        double width;
        double length;
    public:
        void setData(double w, double l)
            { width = w; length = l;}
        double getWidth()
            { return width; }
        double getLength()
            { return length; }
        double getArea()
            { return width * length; }
};
```

# Review Questions and Exercises

## Short Answer

1. What is a throw point?
2. What is an exception handler?
3. Explain the difference between a try block and a catch block.
4. What happens if an exception is thrown, but not caught?
5. What is “unwinding the stack”?
6. What happens if an exception is thrown by a class’s member function?
7. How do you prevent a program from halting when the new operator fails to allocate memory?
8. Why is it more convenient to write a function template than a series of overloaded functions?
9. Why must you be careful when writing a function template that uses operators such as `[]` with its parameters?

# Fill-in-the-Blank

10. The line containing a throw statement is known as the \_\_\_\_\_  
\_\_\_\_\_.
11. The \_\_\_\_\_ block contains code that directly or indirectly might cause an exception to be thrown.
12. The \_\_\_\_\_ block handles an exception.
13. When writing function or class templates, you use a(n) \_\_\_\_\_  
\_\_\_\_\_ to specify a generic data type.
14. The beginning of a template is marked by a(n) \_\_\_\_\_.
15. When defining objects of class templates, the \_\_\_\_\_  
you wish to pass into the type parameter must be specified.
16. A(n) \_\_\_\_\_ template works with a specific data type.

# Algorithm Workbench

17. Write a function that searches a numeric array for a specified value. The function should return the subscript of the element containing the value if it is found in the array. If the value is not found, the function should throw an exception.
18. Write a function that dynamically allocates a block of memory and returns a `char` pointer to the block. The function should take an integer argument that is the amount of memory to be allocated. If the `new` operator cannot allocate the memory, the function should return a null pointer.
19. Make the function you wrote in Question 17 a template.
20. Write a template for a function that displays the contents of an array of any type.

# True or False

21. T F There can be only one catch block in a program.
22. T F When an exception is thrown, but not caught, the program ignores the error.
23. T F Data may be passed with an exception by storing it in members of an exception class.
24. T F Once an exception has been thrown, it is not possible for the program to jump back to the throw point.
25. T F All type parameters defined in a function template must appear at least once in the function parameter list.
26. T F The compiler creates an instance of a function template in memory as soon as it encounters the template.
27. T F A class object passed to a function template must overload any operators used on the class object by the template.
28. T F Only one generic type may be used with a template.
29. T F In the function template definition, it is not necessary to use each type parameter declared in the template prefix.
30. T F It is possible to overload two function templates.
31. T F It is possible to overload a function template and an ordinary (nontemplate) function.
32. T F A class template may not be derived from another class template.
33. T F A class template may not be used as a base class.
34. T F Specialized templates work with a specific data type.

# Find the Error

Each of the following declarations or code segments has errors. Locate as many as possible.

35. `catch`

```
{  
    quotient = divide(num1, num2);  
    cout << "The quotient is " << quotient << endl;  
}  
try (string exceptionString)  
{  
    cout << exceptionString;  
}
```

36. `try`

```
{  
    quotient = divide(num1, num2);  
}  
cout << "The quotient is " << quotient << endl;  
catch (string exceptionString)  
{  
    cout << exceptionString;  
}
```

37. `template <class T>`

```
T square(T number)
```



```
{  
    return T * T;  
}
```

38. 

```
template <class T>  
int square(int number)  
{  
    return number * number;  
}
```

39. 

```
template <class T1, class T2>  
T1 sum(T1 x, T1 y)  
{  
    return x + y;  
}
```

40. Assume the following definition appears in a program that uses the `SimpleVector` class template presented in this chapter.

```
int <SimpleVector> array(25);
```

41. Assume the following statement appears in a program that has defined `valueSet` as an object of the `SimpleVector` class presented in this chapter. Assume `valueSet` is a `vector` of `int`s, and has 20 elements.

```
cout << valueSet<int>[2] << endl;
```

# Programming Challenges

## 1. Date Exceptions

Modify the `Date` class you wrote for Programming Challenge 1 of [Chapter 13](#) (Date). The class should implement the following exception classes:

Demonstrate the class in a driver program.

## 2. Time Format Exceptions

Modify the `MilTime` class you created for Programming Challenge 4 of [Chapter 15](#) (Time Format). The class should implement the following exceptions:

Demonstrate the class in a driver program.

## 3. Minimum/Maximum Templates

Write templates for the two functions `minimum` and `maximum`.

The `minimum` function should accept two arguments and return the value of the argument that is the lesser of the two.

The `maximum` function should accept two arguments and return the value of the argument that is the greater of the two.

Design a simple driver program that demonstrates the templates with various data types.

## 4. Absolute Value Template

Write a function template that accepts an argument and returns its absolute value. The absolute value of a number is its value with no sign. For example, the absolute value of  $-5$

is 5, and the absolute value of 2 is 2. Test the template in a simple driver program.

### 5. **Total Template**

Write a template for a function called `total`. The function should keep a running total of values entered by the user, then return the total. The argument sent into the function should be the number of values the function is to read. Test the template in a simple driver program that sends values of various types as arguments and displays the results.

### 6. **IntArray Class Exception**

[Chapter 14](#) presented an `IntArray` class that dynamically creates an array of integers and performs bounds checking on the array. If an invalid subscript is used with the class, it displays an error message and aborts the program. Modify the class so it throws an exception instead.

### 7. **TestScores Class**

Write a class named `TestScores`. The class constructor should accept an array of test scores as its argument. The class should have a member function that returns the average of the test scores. If any test score in the array is negative or greater than 100, the class should throw an exception. Demonstrate the class in a program.

### 8. **SimpleVector Modification**

Modify the `SimpleVector` class template presented in this chapter to include the member functions `push_back` and `pop_back`. The `push_back` function should accept an argument and insert its value at the end of the array. The

`pop_back` function should accept no argument and remove the last element from the array. Test the class with a driver program.

#### 9. `SearchableVector` Modification

Modify the `SearchableVector` class template presented in this chapter so it performs a binary search instead of a linear search. Test the template in a driver program.

#### 10. `SortableVector` Class Template

Write a class template named `SortableVector`. The class should be derived from the `SimpleVector` class presented in this chapter. It should have a member function that sorts the array elements in ascending order. (Use the sorting algorithm of your choice.) Test the template in a driver program.

#### 11. Inheritance Modification

Assuming you have completed Programming Challenges 9 and 10, modify the inheritance hierarchy of the `SearchableVector` class template so it is derived from the `SortableVector` class instead of the `SimpleVector` class. Implement a member function named `sortAndSearch`, both a sort and a binary search.

#### 12. Specialized Templates

In this chapter, the section *Specialized Templates* within [Section 16.4](#) describes how to design templates that are specialized for one particular data type. The section introduces a method for specializing a version of the `SimpleVector` class template so it will work with strings. Complete the specialization for both the `SimpleVector` and

`SearchableVector` templates. Demonstrate them with a simple driver program.

### 13. Exception Project

This assignment assumes you have completed Programming Challenge 1 of [Chapter 15](#) (`Employee` and `ProductionWorker` Classes). Modify the `Employee` and `ProductionWorker` classes so they throw exceptions when the following errors occur:

- The `Employee` class should throw an exception named `InvalidEmployeeNumber` when it receives an employee number that is less than 0 or greater than 9999.
- The `ProductionWorker` class should throw an exception named `InvalidShift` when it receives an invalid shift.
- The `ProductionWorker` class should throw an exception named `InvalidPayRate` when it receives a negative number for the hourly pay rate.

Write a driver program that demonstrates how each of these exception conditions works.



**Solving the Exception Project Problem**

---

# Chapter 17 The Standard Template Library

---

## Topics

17.1 Introduction to the Standard Template Library [📄](#)

17.2 STL Container and Iterator Fundamentals [📄](#)

17.3 The `vector` Class [📄](#)

17.4 The `map`, `multimap`, and `unordered_map` Classes [📄](#)

17.5 The `set`, `multiset`, and `unordered_set` Classes [📄](#)

17.6 Algorithms [📄](#)

17.7 Introduction to Function Objects and Lambda Expressions [📄](#)

# 17.1 Introduction to the Standard Template Library

## Concept:

The Standard Template Library is an extensive collection of templates for useful data structures and algorithms.

In addition to its runtime library, which you have used throughout this book, C++ also provides an extensive library of templates. The *Standard Template Library* (or STL) contains numerous generic templates for classes and functions. Most of the templates in the STL can be grouped into the following categories:

- **Containers:** Class templates for objects that store and organize data
- **Iterators:** Class templates for objects that behave like pointers, and are used to access the individual data elements in a container
- **Algorithms:** Function templates that perform various operations on elements of containers

This chapter introduces many of the STL's class and function templates.



# 17.2 STL Container and Iterator Fundamentals

**Concept:**

A container is an object that holds a collection of values or other objects. An iterator is an object that is used to iterate over the items in a collection, providing access to them.

# Containers

There are two types of container classes in the STL: *sequence* and *associative*. A sequence container stores its data sequentially in memory, in a fashion similar to an array. An associative container stores its data in a nonsequential way that makes it faster to locate elements.

The sequence containers currently provided in the STL are listed in [Table 17-1](#). (Note that the `deque` container will be discussed in [Chapter 19](#), and the `list` and `forward_list` containers will be discussed in [Chapter 18](#).)

## Table 17-1 Sequence Containers

The associative containers currently provided in the STL are listed in [Table 17-2](#).

## Table 17-2 Associative Containers

In addition to the classes listed in [Tables 17-1](#) and [17-2](#), the STL also provides the three container adapter classes listed in [Table 17-3](#). A container *adapter class* is not itself a container, but a class that adapts one of the other containers to a specific use. Note we will discuss these classes in [Chapter 19](#).

## Table 17-3 Container Adapter Classes

The container and container adapter classes are declared in various STL header files. [Table 17-4](#) lists the necessary header files that you will need to include, depending on the containers you intend to use.

### **Table 17-4 Header Files**

# Introduction to the `array` Class

**11** Perhaps the simplest container in the STL is the `array` class, which was introduced in C++ 11. An `array` object works very much like a regular array. It is a fixed-size container that holds elements of the same data type. In fact, an `array` object uses a traditional array, internally, to store its elements. An advantage `array` objects have over regular arrays is that `array` objects have a `size()` member function that returns the number of elements contained in the object.

When you define an `array` object, you must specify the data type of its elements, and the number of elements the object will store. Here is an example:

```
array<int, 5> numbers;
```

This statement defines an `array` object named `numbers`. Inside the angled brackets `<>`, the data type `int` is the type of each element, and the value 5 is the number of elements the object will have. You can provide an initialization list to initialize an `array`, as shown here:

```
array<int, 5> numbers = {1, 2, 3, 4, 5};
```

Here is an example of defining an `array` to hold four strings:

```
array<string, 4> names = {"Jamie", "Ashley", "Doug", "Claire"};
```

The `array` class overloads the `[]` operator, giving you the ability to access elements using a subscript, just as you would with a regular array. **Program 17-1** [📄](#) gives a simple demonstration of creating and initializing an `array` object, and displaying its elements.



## The array Container

## Program 17-1


```
1  #include <iostream>
2  #include <string>
3  #include <array>
4  using namespace std;
5
6  int main()
7  {
8      const int SIZE = 4;
9
10     // Store some names in an array object.
11     array<string, SIZE> names = {"Jamie",
12     "Ashley", "Doug", "Claire"};
13
14     // Display the names.
15     cout << "Here are the names:\n";
16     for (int index = 0; index < names.size();
17     index++)
18         cout << names[index] << endl;
19 }
```

## Program Output

```
Here are the names:  
Jamie  
Ashley  
Doug  
Claire
```

Take a closer look at the following lines of code in [Program 17-1](#) :

- The statement in line 11 defines an `array` object named `names`, initialized with four strings.
- The `for` loop in lines 15 and 16 displays all of the strings. Notice the `array` object's `size()` member function is used in the loop's test expression.
- In line 16, the `[]` operator is used to access the object's elements.

The `for` loop in lines 15 and 16 of [Program 17-1](#)  is useful to demonstrate the use of the `array` class's `size()` member function, but we could easily rewrite it as a range-based `for` loop.

```
for (auto element : names)
    cout << element << endl;
```



## **Warning!**

The `array` class's `[]` operator does not perform bounds checking. As with regular arrays, you must be careful not to use a subscript that is out of bounds with an `array` object.

As you can see, the `array` class is an object-oriented alternative to a traditional array in C++. The `array` class also provides several member functions that give additional capabilities. [Table 17-5](#) lists the `array` class's member functions.

### **Table 17-5 The `array` Member Functions**

Notice many of the member functions listed in [Table 17-5](#) return iterators. Iterators are a fundamental part of the STL, so it is important to have an understanding of them.



# Iterators



## Iterators

Iterators are objects that work like pointers, and are used to access data stored in containers. As the name implies, you can use an iterator to iterate over the contents of a container. There are currently five categories of iterators, as described in [Table 17-6](#).<sup>1</sup>

<sup>1</sup> The C++17 standard will introduce a sixth category, the contiguous iterator. A contiguous iterator is a random-access iterator that points to elements known to be stored in contiguous memory locations.

### Table 17-6 Categories of Iterators

Iterators are associated with containers. The type of container you have determines the category of iterator you use. For example:

- The `array`, `vector`, and `deque` containers use random-access iterators.

- The `list`, `set`, `multiset`, `map`, and `multimap` containers use bidirectional iterators.
- The `forward_list`, `unordered_map`, `unordered_multimap`, `unordered_set`, and `unordered_multiset` containers use forward iterators.

Iterators are like pointers in the following ways:

- An iterator can point to an element in a container.
- You can use the `*` operator to dereference an iterator, getting the element that it points to.
- When an iterator points to an object, you can use the `->` operator to access the object's members.
- You can use the `=` operator to assign an iterator to an element.
- You can use the `==` and `!=` operators to compare two iterators.
- You can use the `++` operator to increment an iterator, thus moving it to the next element in the container. You can also use the `+` operator to add an integer to an iterator, thus moving it forward in the container by a number of elements.
- If you are using a bidirectional or random-access iterator, you can use the `--` operator to decrement the iterator, thus moving it to the previous element in the container. You can also use the `-` operator to subtract an integer from an iterator, thus moving it backward in the container by a number of elements.

## Defining an Iterator

Before you can define an iterator, you have to know the type of container with which you want to use the iterator. The general format of an iterator definition is:

```
containerType::iterator iteratorName;
```

In the general format, `containerType` is the STL container type, and `iteratorName` is the name of the iterator variable that you are defining. For example, suppose we have defined an `array` object, as follows:

```
array<string, 3> names = {"Sarah", "William", "Alfredo"};
```

We can define an iterator that will work with the `array` object with the following statement:

```
array<string, 3>::iterator it;
```

This statement defines an iterator named `it`, that can be used with an `array<string, 3>` object. The compiler automatically chooses the right type of iterator (in this case, a random-access iterator).

# Getting an Iterator from a Container Object

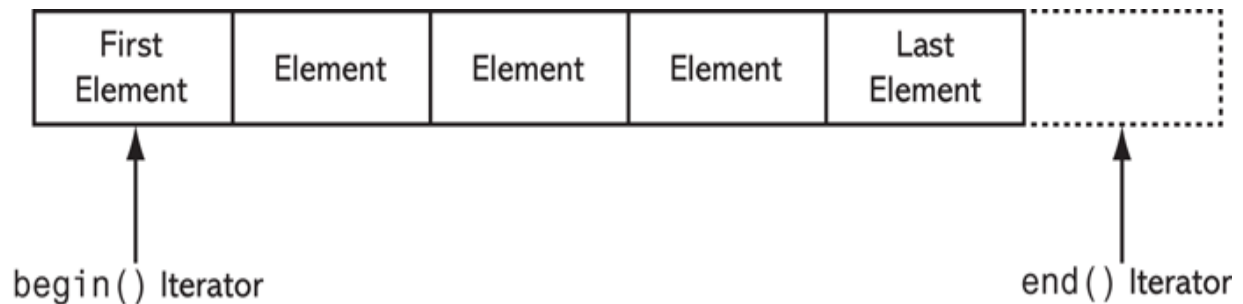
All of the container classes in the STL provide a `begin()` member function and an `end()` member function. The `begin()` member function is straightforward: It returns an iterator pointing to the first element in a container. For example, the following code snippet does the following:

1. It defines an `array` object initialized with three strings.
2. It defines an iterator that can be used with the `array` object.
3. It makes the iterator point to the first element in the `array` object.
4. It uses the `*` operator to dereference the iterator, and displays the element to which the iterator points.

```
// Define an array object. (1)
array<string, 3> names = {"Sarah", "William", "Alfredo"};
// Define an iterator for the array object. (2)
array<string, 3>::iterator it;
// Make the iterator point to the array object's first element.
(3)
it = names.begin();
// Display the element that the iterator points to. (4)
cout << *it << endl;
```


The `end()` member function returns an iterator pointing to the position *after* the last element. This means it returns an iterator that does not point to an element, but points to the end of the container. This is illustrated in [Figure 17-1](#).

**Figure 17-1** Iterators returned from the `begin()` and `end()` member functions



You typically use the `end()` member function to know when you have reached the end of a container in algorithms that iterate over a range of elements. For example, the following code snippet shows an iterator being used with a `while` loop to display the contents of an `array` object:

```
// Define an array object.
array<string, 3> names = {"Sarah", "William", "Alfredo"};
// Define an iterator for the array object.
array<string, 3>::iterator it;
// Make the iterator point to the array object's first element.
it = names.begin();
// Display the array object's contents.
while (it != names.end())
{
    cout << *it << endl;
    it++;
}
```

The code previously shown could be shortened somewhat by using a `for` loop instead of a `while` loop. [Program 17-2](#)  shows an example.

## Program 17-2

```
1  #include <iostream>
2  #include <string>
3  #include <array>
4  using namespace std;
5
6  int main()
7  {
8      const int SIZE = 3;
9
10     // Store some names in an array object.
11     array<string, SIZE> names = {"Sarah",
12     "William", "Alfredo"};
13
14     // Create an iterator for the array
15     object.
16     array<string, SIZE>::iterator it;
17
18     // Display the names.
19     cout << "Here are the names:\n";
20     for (it = names.begin(); it !=
21     names.end(); it++)
22         cout << *it << endl;
```

```
21     return 0;  
22 }
```

## Program Output

```
Here are the names:  
Sarah  
William  
Alfredo
```



## Using `auto` to Define an Iterator



Quite often, you can use `auto` to simplify the definition of an iterator. For example, any time you are initializing an iterator with the value that is returned from a member function, such as `begin()`, you can use `auto` in the iterator's declaration. For example, look at the following code:

```
array<string, 3> names = {"Sarah", "William", "Alfredo"};
array<string, 3>::iterator it = names.begin();
```

The second statement defines an iterator named `it`, and calls the `names.begin()` member function to initialize it. This statement can be rewritten, as shown in the following code:

```
array<string, 3> names = {"Sarah", "William", "Alfredo"};
auto it = names.begin();
```

The `auto` declaration shown in the second statement works because the `names.begin()` function returns an object of the `array<string, 3>::iterator` type. So, the compiler can determine that `it` should be an object of the `array<string, 3>::iterator` type. This is especially useful in `for` loops that use iterators to step through the elements of a container. For example, look at [Program](#)

**17-3** . It is similar to **Program 17-2** , but in this version, the iterator is `auto` declared in the initialization expression of the `for` loop (in line 15).

## Program 17-3

```
1  #include <iostream>
2  #include <string>
3  #include <array>
4  using namespace std;
5
6  int main()
7  {
8      const int SIZE = 4;
9
10     // Store some names in an array object.
11     array<string, SIZE> names = {"Jamie",
12     "Ashley", "Doug", "Claire"};
13
14     // Display the names.
15     cout << "Here are the names:\n";
16     for (auto it = names.begin(); it !=
17     names.end(); it++)
18         cout << *it << endl;
19 }
```

## Program Output

```
Here are the names:
```

```
Sarah
```

```
William
```

```
Alfredo
```

## Mutable Iterators and `const_iterator`s

An iterator of the `iterator` type gives you read/write access to the element to which the iterator points. This is commonly known as a *mutable iterator*. The following code snippet shows an example:

```
// Define an array object.
array<int, 5> numbers = {1, 2, 3, 4, 5};
// Define an iterator for the array object.
array<int, 5>::iterator it;
// Make the iterator point to the array object's first element.
it = numbers.begin();
// Use the iterator to change the element.
*it = 99;
```

In this code snippet, the `numbers` object initially contains the values 1, 2, 3, 4, and 5. The last statement dereferences the `it` iterator (which points to the first element) and changes the element's value to 99. After the last statement executes, the `numbers` object contains the values 99, 2, 3, 4, and 5.

If you want to make sure that nothing changes the contents of a container, you can use the `const` modifier with the container definition to make the container's contents constant. Here is an example:

```
const array<string, 3> names = {"Sarah", "William", "Alfredo"};
```

This statement defines `names` as a `const array` object. As a result, the elements in the container are constant, and cannot be modified. (Attempting to modify the container's contents will result in an error at compile time.) If we need an iterator to work with the object, we must use a `const_iterator`, which provides read-only access to any element to which it points. The following statement shows an example of how to define a `const_iterator`:

```
array<string, 3>::const_iterator it;
```

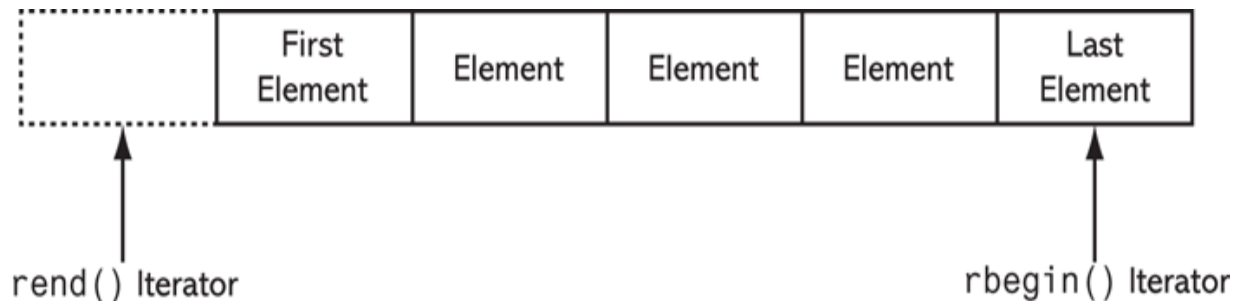
All of the container classes in the STL provide a `cbegin()` member function and a `cend()` member function. The `cbegin()` member function returns a `const_iterator` pointing to the first element in a container. The `cend()` member function returns a `const_iterator` pointing to the end of the container. When working with `const_iterator`s, simply use the container class's `cbegin()` and `cend()` member functions instead of the `begin()` and `end()` member functions.

# Reverse Iterators

A *reverse iterator* is a bidirectional or random-access iterator that works in reverse, allowing you to iterate backward over the elements in a container. When using a reverse iterator, the last element in a container is considered the first element, and the first element is considered the last element. The `++` operator moves a reverse iterator backward, and the `--` operator moves a reverse iterator forward.

The following STL containers support the use of reverse iterators: `array`, `deque`, `list`, `map`, `multimap`, `multiset`, `set`, and `vector`. All of these classes provide an `rbegin()` member function and an `rend()` member function. The `rbegin()` member function returns a reverse iterator pointing to the last element in a container, and the `rend()` member function returns an iterator pointing to the position *before* the first element. This is illustrated in [Figure 17-2](#).

**Figure 17-2** Iterators returned by the `rbegin()` and `rend()` member functions



To create a reverse iterator, you define it as `reverse_iterator`. The following code snippet shows an example of using a reverse iterator to display the contents of an `array` object in reverse order:

```
// Define an array object.
array<int, 5> numbers = {1, 2, 3, 4, 5};

// Define a reverse iterator for the array object.
array<int, 5>::reverse_iterator it;

// Display the elements in reverse order.
for (it = numbers.rbegin(); it != numbers.rend(); it++)
    cout << *it << endl;
```

Iterators that are declared as `reverse_iterator` are mutable, meaning they give you read/write access to the element being pointed to. If you need a reverse iterator to work with a `const` container, you must use a `const_reverse_iterator`, which provides read-only access to any element that it points to. The following code shows an example of how to create a `const_reverse_iterator`:

```
const array<string, 3> names = {"Sarah", "William", "Alfredo"};
array<string, 3>::const_reverse_iterator it;
```

Each of the STL container classes that supports reverse iterators provides a `crbegin()` member function and a `crend()` member



function. The `crbegin()` member function returns a `const_reverse_iterator` pointing to the last element in the container. The `crend()` member function returns a `const_reverse_iterator` pointing to the position before the first element in the container.



## Checkpoint

17.1 What two types of containers does the STL provide?

17.2 What is a container adapter class?

17.3 What is an iterator?

17.4 Suppose you are writing a program that uses the `array`, `multimap`, and `vector` classes. What header files must you `#include` in the program, in order to use these classes?

17.5 What is the difference between a bidirectional iterator and a random-access iterator?

17.6 What does the `++` operator do when applied to an iterator?

17.7 What does a container's `begin()` and `end()` member functions return?

17.8 What is the difference between a mutable iterator and a `const_iterator`?

17.9 What is a reverse iterator?

17.10 What does a container's `rbegin()` and `rend()` member functions return?

## 17.3 The `vector` Class

### Concept:

A `vector` is a sequence container that works like an array, but is dynamic in size.

[Chapter 7](#) introduces the `vector` class and discusses several of the class's member functions. In this section, we will take a closer look at the class, and discuss how to use iterators to access a `vector` container's elements.



### The `vector` Container

Recall from our previous discussions that a `vector` stores a sequence of elements, like an array. In fact, a `vector` uses an array internally to store its elements. A `vector`, however, offers many advantages over an array:

- You do not have to declare the size of a `vector` when you define it.
- A `vector` is dynamic in size. You can add elements to it, or delete elements from it at runtime. The `vector` automatically adjusts its size according to the number of elements it contains.
- A `vector` can report the number of elements it contains.

To use the `vector` class, you need to `#include` the `<vector>` header file in your program. Then, you can define a `vector` object using one of the four `vector` constructors. [Table 17-7](#) shows the general format of a `vector` definition statement using each constructor. [Table 17-8](#) lists most of the `vector` class's member functions.

**Table 17-7** `vector` Definition Statements

**Table 17-8** The `vector` Member Functions

# Review of Basic `vector` Operations

Here is an example of how you would use the default constructor to define a `vector` container to hold integers:

```
vector<int> numbers;
```

This statement defines an empty `vector` container named `numbers`. Inside the angled brackets `<>`, the data type `int` is the type of each element. If you are using a compiler that is compliant with C++11 or later, you can use an initialization list to initialize the `vector`, as shown here:

```
vector<int> numbers = {1, 2, 3, 4, 5};
```

Here is an example of defining a `vector` to hold strings:

```
vector<string> names = {"Joe", "Karen", "Lisa", "Jackie"};
```

The `vector` class overloads the `[]` operator, giving you the ability to access elements using a subscript, just as you would with an array. [Program 17-4](#) gives a simple demonstration of creating and initializing a `vector` object, and displaying its elements.

## Program 17-4

```
1 #include <iostream>
2 #include <vector>
3 using namespace std;
4
5 int main()
6 {
7     const int SIZE = 10;
8
9     // Define a vector to hold 10 int values.
10    vector<int> numbers(SIZE);
11
12    // Store the values 0 through 9 in the vector.
13    for (int index = 0; index < numbers.size(); index++)
14        numbers[index] = index;
15
16    // Display the vector elements.
17    for (auto element : numbers)
18        cout << element << " ";
19    cout << endl;
20
21    return 0;
22 }
```

### Program Output

```
0 1 2 3 4 5 6 7 8 9
```

Keep in mind the `[]` operator has its limitations. Specifically, you can use it only to access elements that already exist in a `vector`. In other words, you cannot add new elements to an existing `vector` using the `[]` operator. For example, the following code will cause an error at run time:

```
vector<int> numbers; // Define an empty vector
numbers[0] = 99; // Error!
```

This code will cause an error because `numbers` is an empty `vector`. Therefore, the element `numbers[0]` does not exist. If you want to add new elements to a `vector`, you must use one of the member functions that exist for that purpose in the `vector` class. For example, the `push_back()` member function adds a new element to the end of the container. You simply call the function, passing the new element's value as an argument. The following code shows an example:

```
vector<int> numbers;
numbers.push_back(10);
numbers.push_back(20);
numbers.push_back(30);
```

The first statement creates an empty `vector` container named `numbers`. The statements that follow add the values 10, 20, and 30 to the `vector`.

You can use the `at()` member function to retrieve a `vector` element by its index with bounds checking. The following code shows an example:

```
vector<string> names = {"Joe", "Karen", "Lisa"};
cout << names.at(3) << endl; // Throws an exception
```

The first statement in this code snippet defines a `vector` with three elements: "Joe" is at index 0, "Karen" is at index 1, and "Lisa" is at index 2. The second statement tries to display the element at index 3, which does not exist. As a result, the `at()` member function throws an `out_of_bounds` exception.

# Using an Iterator with a `vector`

The `vector` class supports the use of iterators of the following types:

- `iterator`
- `const_iterator`
- `reverse_iterator`
- `const_reverse_iterator`

Notice in [Table 17-8](#) the `vector` class provides the following member functions for getting iterators:

`begin()`, `end()`, `cbegin()`, `cend()`, `rbegin()`, `rend()`, `crbegin()`, and `crend()`.

The following code shows an example of using an iterator to display all of the elements of a `vector`:

```
// Create a vector containing names.
vector<string> names = {"Joe", "Karen", "Lisa", "Jackie"};
// Create an iterator.
vector<string>::iterator it;
// Use the iterator to display each element in the vector.
for (it = names.begin(); it != names.end(); it++)
{
    cout << *it << endl;
}
```

We can simplify this code by `auto` declaring the iterator in the initialization expression of the `for` loop, as shown here:

```
// Create a vector containing names.
vector<string> names = {"Joe", "Karen", "Lisa", "Jackie"};
// Use an iterator to display each element in the vector.
for (auto it = names.begin(); it != names.end(); it++)
{
    cout << *it << endl;
}
```

## Inserting New Elements into a `vector`

You can use the `insert` member function to insert one or more new elements at a specified position in a `vector`. There are three overloaded versions of the `insert` member function shown in [Table 17-8](#). [Program 17-5](#) shows an example of how to use the first version.

## Program 17-5

```
1 #include <iostream>
2 #include <vector>
3 using namespace std;
4
5 int main()
6 {
7     // Define a vector with 5 int values.
8     vector<int> numbers = {1, 2, 3, 4, 5};
9
10    // Define an iterator pointing to the second element.
11    auto it = numbers.begin() + 1;
12
13    // Insert a new element with the value 99.
14    numbers.insert(it, 99);
15
16    // Display the vector elements.
17    for (auto element : numbers)
18        cout << element << " ";
19    cout << endl;
20
21    return 0;
22 }
```

### Program Output

```
1 99 2 3 4 5
```

Let's take a closer look at the program:

- Line 8 defines a `vector` of `int`s, initialized with the values 1, 2, 3, 4, and 5.
- Line 11 defines an iterator that is pointing at the second element in the `vector`.
- Line 14 inserts a new element just before the one that `it` points to. The new element contains the value 99.




- The loop in lines 17 and 18 display all of the `vector`'s elements.

The second version of the `insert` member function allows you to insert multiple elements, each with the same value. The following code snippet shows an example:

```
// Define a vector with 5 int values.
vector<int> numbers = {1, 2, 3, 4, 5};
// Define an iterator pointing to the second element.
auto it = numbers.begin() + 1;
// Insert 3 new elements, each with the value 99.
numbers.insert(it, 3, 99);
```

The last statement inserts three elements, each with the value 99. After the statement executes, the vector will contain the following elements: `1 99 99 99 2 3 4 5`

The third version of the `insert` member function allows you to insert a range of elements, perhaps from a different container, into the `vector`. The function takes three iterators as arguments. The first iterator specifies the position where the new elements will be inserted. The second and third iterators mark the beginning and end of a range of elements to be inserted. [Program 17-6](#)  demonstrates the function by inserting a range of elements from one `vector` into another.


## Program 17-6

```
1 #include <iostream>
2 #include <vector>
3 using namespace std;
4
5 int main()
6 {
7     // Define two vectors.
8     vector<int> v1 = {1, 2, 3};
9     vector<int> v2 = {100, 200, 300, 400, 500};
10
11     // Define iterators
12     auto it1 = v1.begin() + 1; // Points at 2 in v1
13     auto it2 = v2.begin();     // Points at 100 in v2
14     auto it3 = v2.begin() + 3; // Points at 400 in v2
15
16     // Insert a range of elements into v1.
17     v1.insert(it1, it2, it3);
18
19     // Display the elements of v1.
20     for (auto element : v1)
21         cout << element << " ";
22     cout << endl;
23
24     return 0;
25 }
```

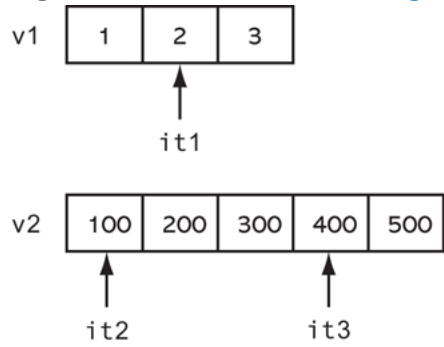
### Program Output

```
1 100 200 300 2 3
```

**Program 17-6** defines two `vector`s: `v1` and `v2`. Line 12 defines an iterator, `it1`, pointing to the second element of `v1`. Line 13 defines an iterator, `it2`, pointing to the first element of `v2`. Line 14 defines an iterator, `it3`, pointing to the fourth element of `v2`. These iterator positions are illustrated in

**Figure 17-3** . Then, line 17 inserts the range of elements from `it2` to `it3` (not including `it3`) into `v1`, before the element at `it1`.

**Figure 17-3** The iterators of **Program 17-6** 




# Storing Objects of Your Own Classes as Values in a `vector`

In the examples previously shown, we stored strings and primitive values in `vector`s. It is often useful to store objects of classes that you have written in a `vector`. For example, the `Product` class, shown here, keeps information about a product. Specifically, it keeps the product's name and the number of units on hand.

## Contents of `Product.h`

```
1 #ifndef PRODUCT_H
2 #define PRODUCT_H
3 #include <string>
4 using namespace std;
5
6 class Product
7 {
8 private:
9     string name;
10    int units;
11 public:
12    Product(string n, int u)
13    { name = n;
14      units = u; }
15
16    void setName(string n)
17    { name = n; }
18
19    void setUnits(int u)
20    { units = u; }
21
22    string getName() const
23    { return name; }
24
25    int getUnits() const
26    { return units; }
27 };
28 #endif
```


Program 17-7  shows how we can define and initialize a `vector` to hold `Product` objects.

## Program 17-7

```
1 #include <iostream>
2 #include <vector>
3 #include "Product.h"
4 using namespace std;
5
6 int main()
7 {
8     // Create a vector of Product objects.
9     vector<Product> products =
10    {
11        Product("T-Shirt", 20),
12        Product("Calendar", 25),
13        Product("Coffee Mug", 30)
14    };
15
16    // Display the vector elements.
17    for (auto element : products)
18    {
19        cout << "Product: " << element.getName() << endl;
20        << "Units: " << element.getUnits() << endl;
21    }
22
23    return 0;
24 }
```

## Program Output

```
Product: T-Shirt  
Units: 20  
Product: Calendar  
Units: 25  
Product: Coffee Mug  
Units: 30
```

**Program 17-8**  shows an example of using the `push_back` member function to add `Product` objects to an existing `vector`, then using an iterator to display the contents of the `vector`. Notice the use of the `->` operator in lines 25 and 26. In those lines, it points to a `Product` object, so the `->` operator is used to call the object's `getName()` and `getUnits()` member functions.

## Program 17-8

```
1 #include <iostream>
2 #include <string>
3 #include <vector>
4 #include "Product.h"
5 using namespace std;
6
7 int main()
8 {
9     // Create Product objects.
10    Product prod1("T-Shirt", 20);
11    Product prod2("Calendar", 25);
12    Product prod3("Coffee Mug", 30);
13
14    // Create a vector to hold the Products
15    vector<Product> products;
16
17    // Add the products to the vector.
18    products.push_back(prod1);
19    products.push_back(prod2);
20    products.push_back(prod3);
21
22    // Use an iterator to display the vector contents.
23    for (auto it = products.begin(); it != products.end(); it++)
24    {
25        cout << "Product: " << it->getName() << endl
26             << "Units: " << it->getUnits() << endl;
27    }
28
29    return 0;
30 }
```

## Program Output



Product: T-Shirt

Units: 20

Product: Calendar

Units: 25

Product: Coffee Mug


Units: 30

# Inserting Elements with the `emplace()` and `emplace_back()` Member Functions

**11** Member functions such as `insert()` and `push_back()` can cause temporary objects to be created in memory while the insertion is taking place. For programs that do not make a lot of insertions, the overhead of creating temporary objects is not usually a problem. However, for programs that insert a lot of objects into containers, member functions such as `insert()` and `push_back()` can be inefficient.

To improve runtime performance, C++11 introduced a new family of member functions that use a technique known as *emplacement* to insert new elements. The process of emplacement avoids the creation of temporary objects in memory while a new object is being inserted into a container. As a result, the emplacement functions are much more efficient than functions such as `insert()` and `push_back()`, especially when a lot of objects are being inserted into a container.

The `vector` class provides two member functions that use emplacement: `emplace()` and `emplace_back()`. When you use one of these member functions, it is not necessary to instantiate, ahead of time, the object you are going to insert. Instead, you pass to the emplacement function any arguments that you would normally pass to the constructor of the object you are inserting. The emplacement function handles the construction of the object, forwarding the arguments to its constructor.


**Program 17-9**  shows an example of how we can use the `emplace_back()` member function to add `Product` objects to a `vector`. Notice we do not instantiate the `Product` class in the program. Instead, in lines 12 through 14 we pass the arguments that we would normally pass to the `Product` class constructor, to the `emplace_back()` member function. The `emplace_back()` member function constructs the objects in the `vector`. (This type of object construction is known as *in-place construction*.)

## Program 17-9

```
1 #include <iostream>
2 #include <vector>
3 #include "Product.h"
4 using namespace std;
5
6 int main()
7 {
8     // Create a vector to hold Products.
9     vector<Product> products;
10
11     // Add Products to the vector.
12     products.emplace_back("T-Shirt", 20);
13     products.emplace_back("Calendar", 25);
14     products.emplace_back("Coffee Mug", 30);
15
16     // Use an iterator to display the vector contents.
17     for (auto it = products.begin(); it != products.end(); it++)
18     {
19         cout << "Product: " << it->getName() << endl;
20         << "Units: " << it->getUnits() << endl;
21     }
22
23     return 0;
24 }
```

## Program Output

```
Product: T-Shirt
Units: 20
Product: Calendar
Units: 25
Product: Coffee Mug
Units: 30
```

The `emplace()` member function constructs an object at a specified location in the `vector`. The first argument you pass to the `emplace()` member function is an iterator. The new element will be constructed at the position just before the element that the iterator points to. After the iterator, you pass the list of arguments that is to be forwarded to the new object's constructor. [Program 17-10](#)  shows an example.

## Program 17-10

```
1 #include <iostream>
2 #include <vector>
3 #include "Product.h"
4 using namespace std;
5
6 int main()
7 {
8     // Create a vector to hold Products.
9     vector<Product> products =
10    {
11        Product("T-Shirt", 20),
12        Product("Coffee Mug", 30)
13    };
14
15    // Get an iterator to the 2nd element.
16    auto it = products.begin() + 1;
17
18    // Insert another Product into the vector.
19    products.emplace(it, "Calendar", 25);
20
21    // Display the vector contents.
22    for (auto element : products)
23    {
24        cout << "Product: " << element.getName() << endl;
25        << "Units: " << element.getUnits() << endl;
26    }
27
28    return 0;
29 }
```

## Program Output

```
Product: T-Shirt
Units: 20
Product: Calendar
Units: 25
Product: Coffee Mug
Units: 30
```

Let's take a closer look at the program:

- Lines 9 through 13 create a `vector` named `products`, initialized with two `Product` objects.
- Line 16 defines an iterator, `it`, pointing to the second element in the `vector`.
- Line 19 inserts a new element into the `vector`, just before the element that `it` points to. The new element will be a `Product` object that is constructed, with the arguments "Calendar" and 25 passed as arguments to the constructor.

## The `capacity()`, `max_size()`, `shrink_to_fit()`, and `reserve()` Member Functions

The `vector` container uses a dynamically allocated array to hold its elements. When the underlying array is full, and another element is added to the vector, the vector has to increase the size of its underlying array. Typically, this means that a new array must be allocated, all of the elements of the old array must be copied to the new array, and the old array must be deallocated.

To prevent this process from happening each time a new element is added, it is common for the `vector` class to allocate more memory than it needs. That way, a certain number of elements can be added without causing the reallocation process to take place. So, a vector object has two sizes: (1) the number of elements that are stored in the vector, and (2) the number of elements that can be stored in the vector without causing its underlying array to be reallocated.

You already know that the `size()` member function returns the number of elements that are currently stored in the `vector`. The `vector` class also has a `capacity()` member function that returns the number of elements that the container's underlying array can currently store, without allocating more memory. In addition, the `max_size()` member function returns the theoretical maximum number of elements that the `vector` can ever store.

The value returned from a `vector`'s `capacity()` member function will always be greater than or equal to the value returned by the `size()` member function. If you need to increase a `vector`'s capacity, you can call the `reserve()` member function to make the request. You pass an integer argument to specify the desired number of elements. If you need to decrease a `vector`'s capacity, you can call the `shrink_to_fit()` member function to make the request. The function takes no arguments, and it simply shrinks the `vector`'s underlying array so its capacity is the same as the `vector`'s size.

## Checkpoint

17.11 Write a statement that defines an empty `vector` object named `avect` that can hold strings.

17.12 Write a statement that defines a `vector` object named `avect` that can hold `int`s. The `vector` should have ten elements (initialized with the default value 0).

17.13 Write a statement that defines a `vector` object named `avect` that can hold `int`s. The `vector` should have 100 elements, each initialized with the value 1.

17.14 Write a statement that defines a `vector` object named `v1` that can hold `int`s. The `vector` should be a copy of another `vector` name `v2`.

17.15 What happens when you use an invalid index with the `vector` class's `at()` member function?

17.16 What is the difference between the `vector` class's `insert()` member function and `push_back()` member function?

17.17 If your program will be added a lot of objects to a `vector`, is it best to use the `inert()` member function, or the `emplace()` member function? Why?

17.18 Internally, how does a `vector` store its elements?

17.19 The `vector` class has a `size()` member function and a `capacity()` member function. What is the difference between these two member functions?



## 17.4 The `map`, `multimap`, and `unordered_map` Classes

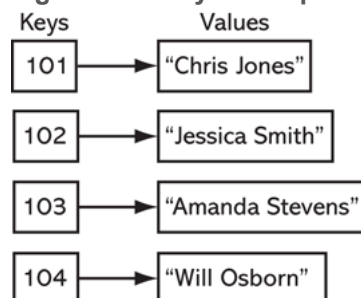
### Concept:

Each element in a map has two parts: a key and a value. Each key is associated with a specific value, and can be used to locate that value.

A *map* is an associative container. Each element that is stored in a map has two parts: a *key* and a *value*. In fact, map elements are commonly referred to as *key–value pairs*. When you want to retrieve a specific value from a map, you use the key that is associated with that value. This is similar to the process of looking up a word in the dictionary, where the words are keys and the definitions are values.

For example, suppose each employee in a company has an ID number, and we want to write a program that lets us look up an employee’s name by entering that employee’s ID number. We could create a map in which each element contains an employee ID number as the key and that employee’s name as the value. This is illustrated in [Figure 17-4](#). If we know an employee’s ID number, then we can retrieve that employee’s name.

**Figure 17-4 Key–value pairs**



Another example would be a program that lets us enter a person’s name and gives us that person’s phone number. The program could use a map in which each element contains a person’s name as the key and that person’s phone number as the value. If we know a person’s name, then we can retrieve that person’s phone number.



**Note:**

Key–value pairs are often referred to as *mappings* because each key is mapped to a value.

# The `map` Class

The STL provides a `map` class template you can use to implement a map container in your programs. The `map` class provides many member functions for storing elements, retrieving elements, deleting elements, iterating over the map, and much more.



## The `map` Container

To use the `map` class, you need to `#include` the `<map>` header file in your program. Then, you can define a `map` object using one of the `map` class constructors. [Table 17-9](#) shows the general format of a `map` definition statement using each constructor. [Table 17-10](#) lists many (but not all) of the `map` class's member functions.

### Table 17-9 `map` Definition Statements

### Table 17-10 Some of the `map` Member Functions

Here is an example of how you might define a `map` container to hold employee ID numbers (as `ints`) and their corresponding employee names (as `strings`):

```
map<int, string> employees;
```

This statement defines a `map` container named `employees`. Inside the angled brackets `<>`, the first data type (`int`) is the type of each key, which in this case are the employee ID numbers. The second data type (`string`) is the type of the corresponding values, which in this case are the employee names. So, each element of this container will be a key–value pair where the key is an `int` and the value is a `string`.

The keys in a `map` container must be unique. No two elements in a `map` container can have the same key value.

# Initializing a Map

You can initialize a `map` with an initialization list. The following code shows an example:

```
map<int, string> employees =  
    {{101, "Chris Jones"}, {102, "Jessica Smith"},  
     {103, "Amanda Stevens"}, {104, "Will Osborn"}};
```

This code creates a `map` container named `employees`, and initializes it as follows:

- The first element is `{101, "Chris Jones"}`. In this element, 101 is the key and “Chris Jones” is the value.
- The second element is `{102, "Jessica Smith"}`. In this element, 102 is the key and “Jessica Smith” is the value.
- The third element is `{103, "Amanda Stevens"}`. In this element, 103 is the key and “Amanda Stevens” is the value.
- The fourth element is `{104, "Will Osborn"}`. In this element, 104 is the key and “Will Osborn” is the value.

Notice inside the initialization list:

- The initialization list is enclosed in a set of curly braces `{}`.
- Each element is enclosed in its own set of curly braces, with the key and the value separated by a comma.
- The elements are separated by commas.

As previously mentioned, the keys in a `map` must be unique. If two or more elements in an initialization list have the same key, only the first will be added to the `map`. The others will be ignored.

# Adding Elements to an Existing Map

The `map` class overloads the `[]` operator, giving you the ability to add new elements to a map with an assignment statement in the following general format:

```
mapName[key] = value;
```

In the general format, `mapName` is the name of the map, and `key` is a key. If `key` already exists in the map, its associated value will be changed to `value`. If the `key` does not exist, it will be added to the map, along with `value` as its associated value. The following code shows an example:

```
map<int, string> employees;  
employees[110] = "Beth Young";  
employees[111] = "Jake Brown";  
employees[112] = "Emily Davis";
```

The first statement creates an empty `map` container named `employees`. The statements that follow then add the following elements to the `map`:

- Key = 110, Value = "Beth Young"
- Key = 111, Value = "Jake Brown"
- Key = 112, Value = "Emily Davis"

Remember, the keys in a `map` must be unique. If you assign a new value to an existing key, the new value will replace the previously stored value. For example, look at the following code:

```
map<int, string> employees;  
employees[110] = "Beth Young";  
employees[110] = "Jake Brown";
```

The first statement creates an empty `map` container named `employees`. The second statement adds an element with the key 110 and the value "Beth Young". The third statement assigns the value "Jake Brown" to the element with the key 110.

# Adding Elements with the `insert()` Member Function

When an element is stored in a `map`, it is stored as object of the `pair` type. The `pair` type is a `struct` that has two member variables: `first` and `second`. The element's key is stored in the `first` member variable, and the element's value is stored in the `second` member variable.

The `map` class provides an `insert()` member function that adds a `pair` object as an element to the map. You can use the STL function `make_pair` to construct a `pair` object, as shown in the following code:

```
map<int, string> employees;
employees.insert(make_pair(110, "Beth Young"));
employees.insert(make_pair(111, "Jake Brown"));
employees.insert(make_pair(112, "Emily Davis"));
```

The first statement creates an empty `map` container named `employees`. The statements that follow then add the following elements to the `map`:

- Key = 110, Value = "Beth Young"
- Key = 111, Value = "Jake Brown"
- Key = 112, Value = "Emily Davis"

If the element that you are inserting with the `insert()` member function has the same key as an existing element, the function will not insert the new element.



## **Note:**

The `pair struct` and the `make_pair` function template are declared in the `<utility>` header file. If you have included the `<map>` header file, the `<utility>` header file will be automatically included as well.

# Adding Elements with the `emplace()` Member Function

The `map` class provides an `emplace()` member function that constructs a new element in the container. You simply call the member function, passing the new element's key and value as arguments. The following code shows an example:

```
map<int, string> employees;  
employees.emplace(110, "Beth Young");  
employees.emplace(111, "Jake Brown");  
employees.emplace(112, "Emily Davis");
```

The first statement creates an empty `map` container named `employees`. The statements that follow then add the following elements to the `map`:

- Key = 110, Value = "Beth Young"
- Key = 111, Value = "Jake Brown"
- Key = 112, Value = "Emily Davis"

If the element that you are inserting with the `emplace()` member function has the same key as an existing element, the function will not insert the new element.

# Retrieving Values from a Map

To retrieve a value from a `map`, you call the `at()` member function, passing the key that is associated with the desired value. If the specified key exists in the container, the function returns its associated value. If the key does not exist, the function throws an exception. The following code shows an example:

```
// Create a map containing employee IDs and names.
map<int, string> employees =
    {{101, "Chris Jones"}, {102, "Jessica Smith"},
     {103, "Amanda Stevens"}, {104, "Will Osborn"}};
// Retrieve a value from the map.
cout << employees.at(103) << endl;
```

This code retrieves and displays the value that is associated with the key 103 from the map. The code will display the string "Amanda Stevens".

If the key you pass to the `at()` member function does not exist in the map, the `at()` member function will throw an exception. To prevent this, you should first call the `count()` member function to determine whether the key exists in the map. You call the `count()` member function, passing a key as the argument. If the specified key exists in the container, the function returns 1. If the key does not exist, the function returns 0. The following code shows an example:

```
// Create a map containing employee IDs and names.
map<int, string> employees =
    {{101, "Chris Jones"}, {102, "Jessica Smith"},
     {103, "Amanda Stevens"}, {104, "Will Osborn"}};
// Retrieve a value from the map.
if (employees.count(103))
    cout << employees.at(103) << endl;
else
    cout << "Employee not found.\n";
```



# Deleting Elements

You can delete, or erase, an element from a `map` using the `erase()` member function. You call the `erase()` member function, passing the key that is associated with the element you want to erase. The following code shows an example:

```
// Create a map containing employee IDs and names.
map<int, string> employees =
    {{101, "Chris Jones"}, {102, "Jessica Smith"},
     {103, "Amanda Stevens"}, {104, "Will Osborn"}};
// Delete the employee with the ID 102.
employees.erase(102);
```

This code creates a `map` container with four elements. Then, it deletes the element with the key 102 (and the value “Jessica Smith”). The `map` then contains only three elements.

The `erase()` member function returns 1 if the specified element was successfully erased, or 0 if it was not found.

# Iterating Over a Map with the Range-Based `for` Loop

The range-based `for` loop is a convenient way to iterate over all of the elements in a map. The following code shows an example of how to display all of the elements in a `map`:

```
// Create a map containing employee IDs and names.
map<int, string> employees =
    {{101, "Chris Jones"}, {102, "Jessica Smith"},
     {103, "Amanda Stevens"}, {104, "Will Osborn"}};
// Display each element.
for (auto element : employees)
{
    cout << "ID: " << element.first << "\tName: " << element.second << endl;
}
}
```


Notice we used the `auto` key word in the declaration of the range variable, `element`. The `auto` key word tells the compiler to determine the variable's data type from the context in which it is being used. If we had written the actual data type of the `element` variable, the loop would have looked like this:

```
for (pair<int, string> element : employees)
{
    cout << "ID: " << element.first << "\tName: " << element.second << endl;
}
}
```

As previously mentioned, elements are stored in a `map` container as objects of the `pair` type. The `pair` type is a `struct` that has two member variables: `first` and `second`. The element's key is stored in the `first` member variable, and the element's value is stored in the `second` member variable.

# Using an Iterator with a Map

You can use a bidirectional iterator to access the elements of a `map`. The `map` class has a `begin()` member function that returns an iterator pointing to the first element in the `map`, and an `end()` member function that returns an iterator pointing to the end of the `map` (the position *after* the last element).

**Program 17-11**  shows an example of using an iterator to display all of the elements of a `map`.

## Program 17-11

```
1 // This program demonstrates an iterator with a map.
2 #include <iostream>
3 #include <string>
4 #include <map>
5 using namespace std;
6
7 int main()
8 {
9     // Create a map containing employee IDs and names.
10    map<int, string> employees =
11        { {101,"Chris Jones"}, {102,"Jessica Smith"},
12          {103,"Amanda Stevens"},{104,"Will Osborn"} };
13
14    // Create an iterator.
15    map<int, string>::iterator iter;
16
17    // Use the iterator to display each element in the map.
18    for (iter = employees.begin(); iter != employees.end(); iter++)
19    {
20        cout << "ID: " << iter->first
21             << "\tName: " << iter->second << endl;
22    }
23
24    return 0;
25 }
```

### Program Output

```
ID: 101 Name: Chris Jones
ID: 102 Name: Jessica Smith
ID: 103 Name: Amanda Stevens
ID: 104 Name: Will Osborn
```

Let's take a closer look at [Program 17-11](#) :

- Lines 10 through 12 define a `map` container named `employees`, and initialize it with four elements. Notice the map's type is `map<int, string>`.
- Line 15 defines an iterator that will work with an object of the type `map<int, string>`. The iterator's name is `iter`.
- The `for` loop that appears in lines 18 through 22 uses the iterator to step through the map container.
  - The loop's initialization expression `iter = employees.begin()` causes the iterator to point to the first element in the map.
  - The test expression `iter != employees.end()` causes the loop to execute as long as the iterator does not point to the end of the map.
  - The update expression increments the iterator, moving it to the next element in the map.
  - The body of the loop, in lines 20 and 21, displays the contents of the element to which the iterator is currently pointing. Remember, each element of the map is a `pair` object, with the key stored in the `first` member, and the value stored in the `second` member.



**Note:**

When you access the elements of a `map` from first to last, you access them in order of their keys.



**Note:**

The `end()` member function returns an iterator pointing to the end of the `map`, but it does not point to an actual element. It points to the position where an additional element would exist, if it appeared after the last element.

The `map` class also has a `find()` member function that searches for an element with a specified key. If the element is found, the `find()` function returns an iterator to it. If the element is not found, the `find()` function returns an iterator to the end of the `map`. The following code shows an example:

```
// Create a map containing employee IDs and names.
map<int, string> employees =
    {{101, "Chris Jones"}, {102, "Jessica Smith"},
     {103, "Amanda Stevens"}, {104, "Will Osborn"}};
// Create an iterator.
map<int, string>::iterator iter;
// Find employee 103.
iter = employees.find(103);
// Display the employee data.
if (iter != employees.end())
{
    cout << "ID: " << iter->first
         << "\tName: " << iter->second << endl;
}
else
{
    cout << "Employee not found.\n";
}
```

## Storing `vector`s as Values in a `map`

In [Program 17-12](#), we define a map in which the keys are student names (as strings), and the values are `vector`s containing test scores.

## Program 17-12

```
1 #include <iostream>
2 #include <string>
3 #include <vector>
4 #include <map>
5 using namespace std;
6
7 int main()
8 {
9     // Create vectors to hold test scores.
10    vector<int> student1Scores = {88, 92, 100};
11    vector<int> student2Scores = {95, 74, 81};
12    vector<int> student3Scores = {72, 88, 91};
13    vector<int> student4Scores = {70, 75, 78};
14
15    // Create a map to hold all the test scores.
16    map<string, vector<int>> testScores;
17    testScores["Kayla"] = student1Scores;
18    testScores["Luis"] = student2Scores;
19    testScores["Sophie"] = student3Scores;
20    testScores["Ethan"] = student4Scores;
21
22    // Display each student's test scores.
23    for (auto element : testScores)
24    {
25        // Display the student name.
26        cout << "Student: " << element.first << endl;
27
28        // Display the student's test scores.
29        for (int i = 0; i < element.second.size(); i++)
30        {
31            cout << "\t" << element.second[i] << endl;
32        }
33    }
34    return 0;
35 }
```





## Program Output

```
Student: Ethan
    70
    75
    78
Student: Kayla
    88
    92
    100
Student: Luis
    95
    74
    81
Student: Sophie
    72
    88
    91
```

Let's take a closer look at [Program 17-12](#) :

- Lines 10 through 13 create four `vector`s, each holding a different student's test scores.
- Line 16 defines a `map` container named `testScores`. Notice the `map`'s type is `map<string, vector<int>>`. This indicates the keys will be of the `string` type, and the values will be of the `vector<int>` type.
- Lines 17 through 20 add the following elements to the map:
  - Key = "Kayla", Value = `student1Scores`, which is a `vector<int>` object
  - Key = "Luis", Value = `student2Scores`, which is a `vector<int>` object
  - Key = "Sophie", Value = `student3Scores`, which is a `vector<int>` object
  - Key = "Ethan", Value = `student4Scores`, which is a `vector<int>` object
- The range-based `for` loop that begins in line 23 iterates over each element in the map. Remember that the range variable, `element`, is an object of the `pair` data type. The `element` object's `first` member variable is the element's key, and its `second` member variable is the element's value. So, the expression `element.first` is a string, and the expression `element.second` is a `vector<int>` object. In line 31, the expression `element.second[i]` is an element in the `vector`.

**Program 17-12**  illustrates the process of storing `vector`s as values in a `map`, but the program can be simplified in two ways: (1) When we define the `map`, we can use an initialization list that also creates the `vector` objects. That will allow us to eliminate the `vector` definition statements in lines 10 through 13. (2) We can rewrite the inner `for` loop in lines 29 through 32 as a range-based `for` loop. **Program 17-13**  shows the program with these changes.

## Program 17-13

```
1 #include <iostream>
2 #include <string>
3 #include <vector>
4 #include <map>
5 using namespace std;
6
7 int main()
8 {
9     // Create vectors to hold test scores.
10    map<string, vector<int>> testScores =
11        { {"Kayla", vector<int> {88, 92, 100 }},
12          {"Luis", vector<int> {95, 74, 81 }},
13          {"Sophie", vector<int> {72, 88, 91 }},
14          {"Ethan", vector<int> {70, 75, 78 }} };
15
16    // Display each student's test scores.
17    for (auto element : testScores)
18    {
19        // Display the student name.
20        cout << "Student: " << element.first << endl;
21
22        // Display the student's test scores.
23        for (auto score : element.second)
24        {
25            cout << "\t" << score << endl;
26        }
27    }
28    return 0;
29 }
```

## Program Output

Student: Ethan

70

75

78

Student: Kayla

88

92

100

Student: Luis

95

74

81

Student: Sophie

72

88

91


# Storing Objects of Your Own Classes as Values in a `map`

In the examples previously shown, we stored strings, primitive values, and `vector`s in `map`s. It is often useful to store objects of classes that you have written in a `map`. For example, suppose you are writing a program to keep a contact list, and you want to search for a person's contact information by entering that person's name. You could create a `map` that contains an element for each person in the contact list. In each element, the key is a person's name, and the value is an object containing that person's contact data. You can search the `map`, using a person's name as the key, and retrieve the object containing that person's contact data.

If you want to store an object as a value in a `map`, there is one requirement for that object's class: It must have a default constructor. For example, the `Contact` class shown here holds a person's name and e-mail address. Because it has a default constructor (in lines 12 through 14), objects of this class can be stored as values in a `map`.

## Contents of `Contact.h`

```
1 #ifndef CONTACT_H
2 #define CONTACT_H
3 #include <string>
4 using namespace std;
5
6 class Contact
7 {
8 private:
9     string name;
10    string email;
11 public:
12    Contact()
13    { name = "";
14      email = ""; }
15
16    Contact(string n, string em)
17    { name = n;
18      email = em; }
19
20    void setName(string n)
21    { name = n; }
22
23    void setEmail(string em)
24    { email = em; }
25
26    string getName() const
27    { return name; }
28
29    string getEmail() const
30    { return email; }
31 };
32 #endif
```

**Program 17-14**  demonstrates how to store objects of the `Contact` class in a `map`. The program creates three `Contact` objects, then stores them in a `map`, using each `Contact` object's name field as the key. The user is prompted to enter a name to search for.

## Program 17-14

```
1 #include <iostream>
2 #include <string>
3 #include <map>
4 #include "Contact.h"
5 using namespace std;
6
7 int main()
8 {
9     string searchName; // The name to search for
10
11     // Create some Contact objects
12     Contact contact1("Ashley Miller", "amiller@faber.edu");
13     Contact contact2("Jacob Brown", "jbrown@gotham.edu");
14     Contact contact3("Emily Ramirez", "eramirez@coolidge.edu");
15
16     // Create a map to hold the Contact objects.
17     map<string, Contact> contacts;
18
19     // Create an iterator for the map.
20     map<string, Contact>::iterator iter;
21
22     // Add the contact objects to the map.
23     contacts[contact1.getName()] = contact1;
24     contacts[contact2.getName()] = contact2;
25     contacts[contact3.getName()] = contact3;
26
27     // Get the name to search for.
28     cout << "Enter a name: ";
29     getline(cin, searchName);
30
31     // Search for the name.
32     iter = contacts.find(searchName);
33
34     // Display the results.
35     if (iter != contacts.end())
36     {
37         cout << "Name: " << iter->second.getName() << endl;
```



```

38     cout << "Email: " << iter->second.getEmail() << endl;
39 }
40 else
41 {
42     cout << "Contact not found.\n";
43 }
44
45 return 0;
46 }

```

### Program Output (with Example Input Shown in Bold)

```

Enter a name: Emily Ramirez Enter
Name: Emily Ramirez
Email: eramirez@coolidge.edu

```

### Program Output (with Example Input Shown in Bold)

```


Enter a name: Billy Clark Enter
Contact not found.

```

Let's take a closer look at [Program 17-14](#):

- Lines 12 through 14 create three `Contact` objects named `contact1`, `contact2`, and `contact3`.
- Line 17 defines a `map` named `contacts`. Inside the angled brackets `<>`, the first data type (`string`) is the type of each key. The second data type (`Contact`) is the type of the corresponding values. So, each element of this container will be a key–value pair where the key is a `string` and the value is a `Contact` object.
- Line 20 defines an iterator that can be used with the `contacts` map.
- Line 23 adds an element to the `contacts` map. The key is the string “Ashley Miller”, and the value is the `contact1` object.
- Line 24 adds another element to the `contacts` map. The key is the string “Jacob Brown”, and the value is the `contact2` object.
- Line 25 adds another element to the `contacts` map. The key is the string “Emily Ramirez”, and the value is the `contact3` object.

- Lines 28 and 29 prompt the user to enter a name to search for. The user's input is stored in `searchName`.
- Line 32 calls the `contacts.find()` member function to search for the name that was entered by the user. If the name is found as a key in the map, the member function returns an iterator to the element. If the name is not found, the member function returns an iterator to the end of the map.
- If the name was found, the statements in lines 37 and 38 display the name and e-mail address for the contact. Remember, the iterator is pointing to a `pair` object. The `pair` object's `first` member variable is the element's key, and the `pair` object's `second` member variable is the element's value. So, in lines 37 and 38, the expression `iter->second` references a `Contact` object. The expression `iter->second.getName()` returns that object's `name` field, and the expression `iter->second.getEmail()` returns that object's `email` field.

**Program 17-15**  shows another example in which we use a range-based `for` loop to iterate over a `map` containing `Contact` objects as values.

## Program 17-15

```
1 #include <iostream>
2 #include <string>
3 #include <map>
4 #include "Contact.h"
5 using namespace std;
6
7 int main()
8 {
9     // Create some Contact objects
10    Contact contact1("Ashley Miller", "amiller@faber.edu");
11    Contact contact2("Jacob Brown", "jbrown@gotham.edu");
12    Contact contact3("Emily Ramirez", "eramirez@coolidge.edu");
13
14    // Create a map to hold the Contact objects.
15    map<string, Contact> contacts;
16
17    // Add the contact objects to the map.
18    contacts[contact1.getName()] = contact1;
19    contacts[contact2.getName()] = contact2;
20    contacts[contact3.getName()] = contact3;
21
22    // Display all objects in the map.
23    for (auto element : contacts)
24    {
25        cout << element.second.getName() << "\t"
26             << element.second.getEmail() << endl;
27    }
28
29    return 0;
30 }
```

## Program Output

```
Ashley Miller    amiller@faber.edu
Emily Ramirez   eramirez@coolidge.edu
Jacob Brown     jbrown@gotham.edu
```

In lines 25 and 26, the range variable `element` is a `pair` object. The `pair` object's `first` member variable is the element's key, and the `pair` object's `second` member variable is the element's value. So, the expression `element.second` references a `Contact` object. The expression `element.second.getName()` returns that object's `name` field, and the expression `element.second.getEmail()` returns that object's `email` field.

**Program 17-15** [□](#) illustrates the process of using your own objects as values in a `map`, but the program can be simplified. When we define the `map`, we can use an initialization list that also creates the `Contact` objects. That will allow us to eliminate the `Contact` definition statements in lines 10 through 12. **Program 17-16** [□](#) shows the program with these changes.

## Program 17-16

```
1 #include <iostream>
2 #include <string>
3 #include <map>
4 #include "Contact.h"
5 using namespace std;
6
7 int main()
8 {
9     // Create a map holding the Contact objects.
10    map<string, Contact> contacts =
11        { { "Ashley Miller", Contact("Ashley Miller", "amiller@faber.edu") },
12          { "Jacob Brown",   Contact("Jacob Brown", "jbrown@gotham.edu") },
13          { "Emily Ramirez", Contact("Emily Ramirez", "eramirez@coolidge.edu") }
14        };
15
16    // Display all objects in the map.
17    for (auto element : contacts)
18    {
19        cout << element.second.getName() << "\t"
20             << element.second.getEmail() << endl;
21    }
22
23    return 0;
24 }
```

## Program Output

```
Ashley Miller    amiller@faber.edu
Emily Ramirez    eramirez@coolidge.edu
Jacob Brown      jbrown@gotham.edu
```

# Using an Object of Your Own Class as a Key

You can use objects of a class that you have written as keys in a `map`, as long as the class has overloaded the `<` operator. For example, look at the `Customer` class shown here:

## Contents of `Customer.h`

```
1 #ifndef CUSTOMER_H
2 #define CUSTOMER_H
3 #include<string>
4 using namespace std;
5
6 class Customer
7 {
8 private:
9     int custNumber;
10    string name;
11 public:
12    Customer(int cn, string n)
13    { custNumber = cn;
14      name = n; }
15
16    void setCustNumber(int cn)
17    { custNumber = cn; }
18
19    void setName(string n)
20    { name = n; }
21
22    int getCustNumber() const
23    { return custNumber; }
24
25    string getName() const
26    { return name; }
27
28    bool operator < (const Customer &right) const
29    { bool status = false;
30
31      if (custNumber < right.custNumber)
32      status = true;
33
34      return status; }
```

```
35 };  
36 #endif
```

The Customer class holds two pieces of data about a customer: the customer number (custNumber) and the customer's name (name). The overloaded < operator (in lines 28 through 35) returns true if the custNumber member is less than the parameter's custNumber member. Otherwise, it returns false.

Suppose we are writing a program that assigns seats in a theater to customers, and we want to use Customer objects as the keys in a map. [Program 17-17](#) shows an example. In line 15, the program defines a map that uses Customer objects as keys, and strings as values.





## Program 17-17

```
1 #include <iostream>
2 #include <string>
3 #include <map>
4 #include "Customer.h"
5 using namespace std;
6
7 int main()
8 {
9     // Create some Customer objects.
10    Customer customer1(1001, "Sarah Scott");
11    Customer customer2(1002, "Austin Hill");
12    Customer customer3(1003, "Megan Cruz");
13
14    // Create a map to hold the seat assignments.
15    map<Customer, string> assignments;
16
17    // Use the map to store the seat assignments.
18    assignments[customer1] = "1A";
19    assignments[customer2] = "2B";
20    assignments[customer3] = "3C";
21
22    // Display all objects in the map.
23    for (auto element : assignments)
24    {
25        cout << element.first.getName() << "\t"
26             << element.second << endl;
27    }
28
29    return 0;
30 }
```

## Program Output

```
Sarah Scott    1A
Austin Hill    2B
Megan Cruz     3C
```

**Program 17-17**  illustrates the process of using your own objects as keys in a `map`, but the program can be simplified. When we define the `map`, we can use an initialization list that also creates the `Customer` objects. That will allow us to eliminate the `Customer` definition statements in lines 10 through 12. **Program 17-18**  shows the program with these changes.

## Program 17-18

```
1 #include <iostream>
2 #include <string>
3 #include <map>
4 #include "Customer.h"
5 using namespace std;
6
7 int main()
8 {
9     // Create a map to hold the seat assignments.
10    map<Customer, string> assignments =
11        { { Customer(1001, "Sarah Scott"), "1A"},
12          { Customer(1002, "Austin Hill"), "2B"},
13          { Customer(1003, "Megan Cruz"), "3C" } };
14
15    // Display all objects in the map.
16    for (auto element : assignments)
17    {
18        cout << element.first.getName() << "\t"
19             << element.second << endl;
20    }
21
22    return 0;
23 }
```

## Program Output

```
Sarah Scott    1A
Austin Hill    2B
Megan Cruz     3C
```

# The `unordered_map` Class

**11** Beginning in C++11, the STL provides a class template named `unordered_map` that is similar to the `map` class, except in two regards: (1) the keys in an `unordered_map` are not sorted in any particular way, and (2) the `unordered_map` class has better performance. If you will be making a lot of searches on a large number of elements, and you are not concerned with retrieving them in key order, you should probably use the `unordered_map` class instead of the `map` class.

To use the `unordered_map` class, you must write the `#include <unordered_map>` directive in your program. The `unordered_map` class has a similar set of member functions as the `map` class (many of which are listed in [Table 17-10](#)), and in most cases, working with an `unordered_map` is just like working with a `map`. The following code shows an `unordered_map` being initialized with elements, then an element being retrieved and displayed:

```
// Create an unordered_map containing employee IDs and names.
unordered_map<int, string> employees =
    {{101, "Chris Jones"}, {102, "Jessica Smith"},
     {103, "Amanda Stevens"}, {104, "Will Osborn"}};
// Retrieve a value from the map.
cout << employees.at(103) << endl;
```

The following code shows an example of using a range-based `for` loop to display all of the elements in a `map`:

```
// Create an unordered_map containing employee IDs and names.
unordered_map <int, string> employees =
    {{101, "Chris Jones"}, {102, "Jessica Smith"},
     {103, "Amanda Stevens"}, {104, "Will Osborn"}};
// Display each element.
for (auto element : employees)
{
    cout << "ID:" << element.first << "\tName:" << element.second << endl;
}
}
```



**Note:**

The differences between the `unordered_map` class and the `map` class are a result of the way each internally stores its elements. The `map` class uses a data structure known as a *binary tree*, and the `unordered_map` class uses a *hash table*.

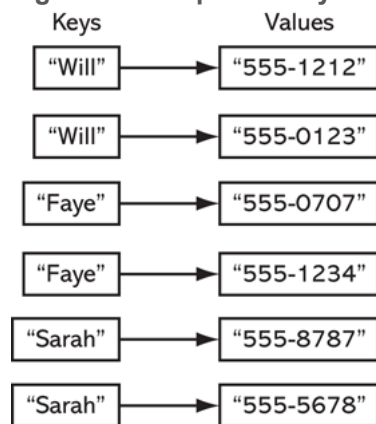
# The `multimap` Class

The `multimap` class lets you create a map container in which multiple elements can have the same key. In other words, duplicate keys are allowed in a `multimap`. To use the `multimap` class, you will need to write the `#include <map>` directive in your program. [Table 17-11](#) lists many (but not all) of the `multimap` class's member functions.

## Table 17-11 Some of the `multimap` Member Functions

For example, in a phone book application, you could store names and phone numbers in a `multimap` container, using the names as keys and the phone numbers as values. If a person has multiple phone numbers, you could store multiple elements using that person's name as the key. [Figure 17-5](#) illustrates this concept.

**Figure 17-5 Duplicate keys stored in a `multimap` container**



In [Figure 17-5](#), there are two elements with the key "Will", two elements with the key "Faye", and two elements with the key "Sarah". [Program 17-19](#) shows how to define a `multimap` and initialize it with these elements.

## Program 17-19

```
1 #include <iostream>
2 #include <string>
3 #include <map>
4 using namespace std;
5
6 int main()
7 {
8     // Define a phonebook multimap.
9     multimap<string, string> phonebook =
10         { {"Will", "555-1212"}, {"Will", "555-0123"},
11           {"Faye", "555-0707"}, {"Faye", "555-1234"},
12           {"Sarah", "555-8787"}, {"Sarah", "555-5678"} };
13
14     // Display the elements in the multimap.
15     for (auto element : phonebook)
16     {
17         cout << element.first << "\t"
18              << element.second << endl;
19     }
20     return 0;
21 }
```

## Program Output

```
Faye    555-0707
Faye    555-1234
Sarah   555-8787
Sarah   555-5678
Will    555-1212
Will    555-0123
```

As with the `map` class, the elements of a `multimap` are ordered. When you iterate over a `multimap`, you retrieve its elements in order of their keys. The `multimap` class also provides many of the same

member functions as the `map` class. There are some differences between the `multimap` class and the `map` class, however, and we will focus on many of those differences in the rest of this section.



## Adding Elements to a `multimap`

Unlike the `map` class, the `multimap` class does not overload the `[]` operator. So, you cannot write an assignment statement to add a new element to a `multimap`. Instead, you can use either the `emplace()` member function, or the `insert()` member function.

The `multimap` class's `emplace()` member function adds a new element to the container. You simply call the member function, passing the new element's key and value as arguments. The following code shows an example:

```
multimap<string, string> phonebook;
phonebook.emplace("Will", "555-1212");
phonebook.emplace("Will", "555-0123");
phonebook.emplace("Faye", "555-0707");
phonebook.emplace("Faye", "555-1234");
phonebook.emplace("Sarah", "555-8787");
phonebook.emplace("Sarah", "555-5678");
```

The first statement creates an empty `multimap` container named `phonebook`. The statements that follow use the `emplace()` member function to add the elements shown in [Figure 17-5](#).

If the element that you are inserting with the `emplace()` member function has the same key as an existing element, the function adds a new element with the same key.

The `insert()` member function adds a `pair` object as an element to the `multimap`. You can use the STL function `make_pair` to construct a `pair` object, as shown in the following code:

```
multimap<string, string> phonebook;
phonebook.insert(make_pair("Will", "555-1212"));
phonebook.insert(make_pair("Will", "555-0123"));
phonebook.insert(make_pair("Faye", "555-0707"));
phonebook.insert(make_pair("Faye", "555-1234"));
phonebook.insert(make_pair("Sarah", "555-8787"));
phonebook.insert(make_pair("Sarah", "555-5678"));
```

The first statement creates an empty `multimap` container named `phonebook`. The statements that follow use the `insert()` member function to add the elements shown in [Figure 17-5](#).

If the element that you are inserting with the `insert()` member function has the same key as an existing element, the function adds a new element with the same key.

## Getting the Number of Elements with a Specified Key

The `multimap` class's `count()` member function accepts a key as its argument, and returns the number of elements that match the specified key. [Program 17-20](#) demonstrates.

### Program 17-20


```
1 #include <iostream>
2 #include <string>
3 #include <map>
4 using namespace std;
5
6 int main()
7 {
8     // Define a phonebook multimap.
9     multimap<string, string> phonebook =
10         { {"Will", "555-1212"}, {"Will", "555-0123"},
11           {"Faye", "555-0707"}, {"Faye", "555-1234"},
12           {"Sarah", "555-8787"}, {"Sarah", "555-5678"} };
13
14     // Display the number of elements that match "Faye".
15     cout << "Faye has " << phonebook.count("Faye") << " elements.\n";
16     return 0;
17 }
```

### Program Output

```
Faye has 2 elements.
```

## Retrieving the Elements with a Specified Key

Like the `map` class, the `multimap` class has a `find()` member function that searches for an element with a specified key. If the key is found, the `find()` function returns an iterator to the first element matching it. If the element is not found, the `find()` function returns an iterator to the end of the `map`.

If you want to retrieve all of the elements matching a specified key, use the `multimap` class's `equal_range` member function. The `equal_range` member function returns a `pair` object. The `pair` object's `first` member is an iterator pointing to the first element in the `multimap` that matches the specified key. The `pair` object's `second` member is an iterator pointing to the position *after* the last element that matches the specified key. [Program 17-21](#)  demonstrates how to use the function.

## Program 17-21

```
1 #include <iostream>
2 #include <string>
3 #include <map>
4 using namespace std;
5
6 int main()
7 {
8     // Define a phonebook multimap.
9     multimap<string, string> phonebook =
10     { {"Will", "555-1212"}, {"Will", "555-0123"},
11     {"Faye", "555-0707"}, {"Faye", "555-1234"},
12     {"Sarah", "555-8787"}, {"Sarah", "555-5678"} };
13
14     // Define a pair variable to receive the object that
15     // is returned from the equal_range member function.
16     pair<multimap<string, string>::iterator,
17     multimap<string, string>::iterator> range;
18
19     // Define an iterator for the multimap.
20     multimap<string, string>::iterator iter;
21
22     // Get the range of elements that match "Faye".
23     range = phonebook.equal_range("Faye");
24
25     // Display all of the elements that match "Faye".
26     for (iter = range.first; iter != range.second; iter++)
27     {
28         cout << iter->first << "\t" << iter->second << endl;
29     }
30
31     return 0;
32 }
```

## Program Output

```
Faye 555-0707
Faye 555-1234
```

Let's take a closer look at the program:

- Lines 9 through 12 define a `multimap` container named `phonebook`, initialized with six elements.
- Lines 16 and 17 define a `pair` variable named `range`. The `range` variable will receive the object that is returned from the `equal_range` member function. The object's `first` and `second` members will both be iterators for the `multimap` container.
- Line 20 defines an iterator named `iter` for the `multimap` container.
- Line 23 calls the `phonebook` container's `equal_range` member function, specifying "Faye" as the key to search for. The `equal_range` function returns a `pair` object that is assigned to the `range` variable.
- The `for` loop in lines 26 through 29 iterates over all of the elements matching the key "Faye", displaying their values. Here are the details of the loop:
  - The `iter` iterator is initially set to `range.first`.
  - The loop repeats as long as `iter` is not equal to `range.second`.
  - At the end of each loop iteration, `iter` is incremented to the next element.
  - Each time the loop iterates, it displays the contents of the element to which `iter` is pointing (line 26).



### **Note:**

When searching for a range of elements with the `equal_range` member function, if the specified key is not found, both iterators will point to the element that would naturally appear after the element that was searched for.

## Deleting Elements from a `multimap`

You can delete, or erase, elements from a `multimap` using the `erase()` member function. You call the `erase()` member function, passing the key that is associated with the elements that you want to erase. All of the elements matching the specified key will be erased from the `multimap`. The `erase()` member function returns the number of elements that were erased. The following code shows an example:

```
// Define a phonebook multimap.
multimap<string, string> phonebook =
    { {"Will", "555-1212"}, {"Will", "555-0123"},
      {"Faye", "555-0707"}, {"Faye", "555-1234"},
      {"Sarah", "555-8787"}, {"Sarah", "555-5678"} };
// Delete Will's phone numbers from the multimap.
phonebook.erase("Will");
```

This code creates a `multimap` container with six elements. Then, it deletes all of the elements with the key "Will". (Two elements will be deleted.) The `multimap` then contains only four elements.

# The `unordered_multimap` Class

**11** Beginning in C++11, the STL provides a class template named `unordered_multimap` that is similar to the `multimap` class, except in two regards: (1) the keys in an `unordered_multimap` are not sorted in any particular order, and (2) the `unordered_multimap` class has better performance. If you will be making a lot of searches on a large number of elements, and you are not concerned with retrieving them in key order, you should probably use the `unordered_multimap` class instead of the `multimap` class.

To use the `unordered_multimap` class, you must write the `#include <unordered_multimap>` directive in your program. The `unordered_multimap` class has a similar set of member functions as the `multimap` class, and in most cases, working with an `unordered_multimap` is just like working with a `multimap`.



## Note:

The differences between the `unordered_multimap` class and the `multimap` class are a result of the way each internally stores its elements. The `multimap` class uses a data structure known as a *binary tree*, and the `unordered_multimap` class uses a *hash table*.

## Checkpoint

17.20 Each element that is stored in a map has two parts. What are they?

17.21 Write a statement that defines a `map` named `myMap`. The keys in `myMap` should be `ints`, and the values should be `strings`.

17.22 Suppose an empty `map` named `employee` has been created. What does the following statement do?

```
employee[543] = "Joanne Manchester";
```

17.23 Describe two ways in which you can retrieve an element with a particular key in a `map`.

17.24 If you want to store objects of a class you have written, as values in a `map`, what do you have to make sure that the class has?

17.25 If you want to store objects of a class you have written, as keys in a `map`, what do you have to make sure that the class has?

17.26 What is the difference between a `map` and an `unordered_map`?

17.27 What is the difference between a `map` and an `multimap`?

## 17.5 The `set`, `multiset`, and `unordered_set` Classes

### Concept:

A set contains a collection of unique values.



### The `set` Container

A *set* is an associative container that stores a collection of unique values in a way that is similar to a mathematical set. You use the STL class template `set` to implement a set container in C++. Here are two important things to know about the STL `set` container:



- All the elements in a `set` must be unique. No two elements can have the same value.
- The elements in a `set` are automatically sorted in ascending order.

To use the `set` class, you will need to `#include` the `<set>` header file in your program. Then, you can define a `set` object using one of the `set` class constructors. [Table 17-12](#) shows the general format of a `set` definition statement using each constructor. [Table 17-13](#) lists many (but not all) of the `set` class's member functions.

### Table 17-12 `set` Definition Statements

### Table 17-13 Some of the `set` Member Functions

Here is an example of how you might define a `set` container to hold integers:

```
set<int> numbers;
```

This statement defines a `set` container named `numbers`. Inside the angled brackets `<>`, the data type `int` is the type of each element. You can provide an initialization list to initialize the `set`, as shown here:

```
set<int> numbers = {1, 2, 3, 4, 5};
```

Here is an example of defining a set to hold strings:

```
set<string> names = {"Joe", "Karen", "Lisa", "Jackie"};
```

A `set` cannot contain duplicate items, so, if the same value appears more than once in an initialization list, it will be added to the `set` only one time. For example, the following `set` will contain the values 1, 2, 3, 4, and 5:

```
set<int> numbers = {1, 1, 2, 3, 3, 3, 4, 5, 5};
```

# Adding Elements to an Existing

`set`

The `set` class provides an `insert()` member function that adds a new element to the container. You simply call the member function, passing the new element's value as an argument. The following code shows an example:

```
set<int> numbers;  
numbers.insert(10);  
numbers.insert(20);  
numbers.insert(30);
```

The first statement creates an empty `set` container named `numbers`. The statements that follow add the values 10, 20, and 30 to the set. If the value that you are inserting already exists in the `set`, the `insert()` member function will do nothing (no new element will be inserted).



## **Note:**

The `set` class also provides the `emplace()` member function, for inserting elements. You will see an example of it momentarily. For a review of the difference between the `emplace()` and `insert()` member functions, see the discussion on emplacement that appears in this chapter's section on `vectors`.

# Iterating Over a `set` with the Range-Based `for` Loop

The range-based `for` loop is a convenient way to iterate over all of the elements in a `set`. The following code shows an example of how to display all of the elements in a `set`:

```
// Create a set containing names.
set<string> names = {"Joe", "Karen", "Lisa", "Jackie"};
// Display each element.
for (string element : names)
{
    cout << element << endl;
}
```

# Using an Iterator with a `set`

You can use a bidirectional iterator to access the elements of a `set`. The `set` class provides the `begin()` and `cbegin()` member functions that return an iterator pointing to the first element in the `set`, and the `end()` and `cend()` member functions that return an iterator pointing to the end of the `set` (the position *after* the last element). The following code shows an example of using an iterator to display all of the elements of a `set`:

```
// Create a set containing names.
set<string> names = {"Joe", "Karen", "Lisa", "Jackie"};
// Create an iterator.
set<string>::iterator iter;
// Use the iterator to display each element in the set.
for (iter = names.begin(); iter != names.end(); iter++)
{
    cout << *iter << endl;
}
```



## **Note:**

The `end()` and `cend()` member functions return an iterator pointing to the end of the `set`, but it does not point to an actual element. It points to the position where an additional element would exist, if it appeared after the last element.

# Determining Whether a Value Exists in a `set`

You can use either the `count()` member function or the `find()` member function to determine whether a value exists in a set. The `count()` member function accepts the desired value as an argument, and returns 1 if the value is found in the `set`, or 0 if the value is not found. Here is an example:

```
set<string> names = {"Joe", "Karen", "Lisa", "Jackie"};
if (names.count("Lisa"))
    cout << "Lisa was found in the set.\n";
else
    cout << "Lisa was not found.\n";
```

The `find()` member function accepts the desired value as an argument, and returns an iterator that points to the element if it is found in the set. If the element is not found, the `find()` function returns an iterator to the end of the `set`. The following code shows an example:



```
// Create a set containing names.
set<string> names = {"Joe", "Karen", "Lisa", "Jackie"};


// Create an iterator.
set<string>::iterator iter;

// Find "Karen".
iter = names.find("Karen");

// Display the result.
if (iter != names.end())
{
    cout << *iter << " was found.\n";
}
else
{
    cout << "Karen was not found.\n";
}
```

# Storing Objects of Your Own Classes in a `set`

You can store objects of a class that you have written in a `set`, as long as the class has overloaded the `<` operator. The `set` class uses the `<` operator to determine the order in which to store elements, and to detect duplicates. (Suppose we are comparing two values: `value1` and `value2`. If `value1` is *NOT* less than `value2`, and `value2` is *NOT* less than `value1`, then the two values are equal. This is the logic that the `set` class uses to determine whether two values are duplicates.)

For example, recall the `Customer` class shown earlier in this chapter, in our discussion of the `map` class. (See the contents of the `Customer.h` file.) The `Customer` class holds two pieces of data about a customer: the customer number and the customer's name. The class also has an overloaded `<` operator that compares customer numbers. If we store objects of the `Customer` class in a `set` container, the objects will be sorted by customer number, and the container will not allow objects with the same customer number to be stored. [Program 17-22](#)  demonstrates this.

## Program 17-22

```
1  #include <iostream>
2  #include <set>
3  #include "Customer.h"
4  using namespace std;
5
6  int main()
7  {
8      // Create a set of Customer objects.
9      set<Customer> customerset =
10         { Customer(1003, "Megan Cruz"),
11           Customer(1002, "Austin Hill"),
12           Customer(1001, "Sarah Scott")
13         };
14
15     // Try to insert a duplicate customer
16     number.
17     customerset.emplace(1001, "Evan Smith");
18
19     // Display the set elements
20     cout << "List of customers:\n";
21     for (auto element : customerset)
22     {
23         cout << element.getCustNumber() << " "
```

```
23         << element.getName() << endl;
24     }
25
26     // Search for customer number 1002.
27     cout << "\nSearching for Customer Number
1002:\n";
28     auto it = customerset.find(Customer(1002,
""));
29
30     if (it != customerset.end())
31         cout << "Found: " << it->getName() <<
endl;
32     else
33         cout << "Not found.\n";
34
35     return 0;
36 }
```

## Program Output

```
List of customers:
1001 Sarah Scott
1002 Austin Hill
1003 Megan Cruz

Searching for Customer Number 1002:
Found: Austin Hill
```

Let's take a closer look at the program:

- Lines 9 through 13 define a `set` container named `customerset`. The container is initialized with three `Customer` objects.
- Line 16 calls the `emplace()` member function to add a `Customer` object to the `set`. However, the customer number that is being passed to the `emplace()` function is already in the `set`. As a result, the object will not be added to the `set`.
- The loop in lines 20 through 24 displays all of the `set` container's elements. Notice in the program output, the elements are retrieved in order of their customer numbers.
- Next, the program searches the `set` container for an object with the customer number 1002. The statement in line 28 defines an iterator, assigning it the value returned from the `find()` member function.

Look carefully at the argument we are passing to the `find()` member function. The expression `Customer(1002, "")` constructs a temporary, nameless `Customer` object that has 1002 as the customer number, and `""` as the customer name. (Because we are simply using this object to search for an element with customer number 1002, there is no need to provide a meaningful value for the customer name.) The `find()` member function will accept this `Customer` object as an argument, and it will search the container for an element that has a matching customer number. (Remember, the `set` container uses the `Customer` class's overloaded `<` operator to determine whether two objects are equal.) If a matching element is found, the function returns an iterator pointing to it. Otherwise, it returns an iterator pointing to the end of the container.

- The if/else statement in lines 30 through 33 tests the iterator to determine whether it is pointing to a matching element, or the end of the container, and displays a message indicating the results of the search.

# The `multiset` Class

The `multiset` class lets you create a set container that can store duplicate elements. To use the `multiset` class, you will need to `#include` the `<set>` header file in your program. The class provides the same member functions as the `set` class, with these two differences:

- In the `set` class, the `count()` member function returns either 0 or 1. In the `multiset` class, the `count()` member function can return values greater than 1.
- In the `set` class, the `equal_range()` member function returns a range with, at most, one element. In the `multiset` class, the `equal_range()` member function can return a range with multiple elements.

# The `unordered_set` and `unordered_multiset` Classes

**11** Beginning in C++11, the STL provides class templates named `unordered_set` and `unordered_multiset`. These are similar to the `set` and `multiset` classes, except in two regards: (1) the values stored in an `unordered_set` or an `unordered_multiset` are not sorted in any particular way, and (2) the `unordered_set` and `unordered_multiset` classes has better performance than the `set` and `multiset` classes. If you will be making a lot of searches on a large number of elements, and you are not concerned with retrieving them in any order, you should probably use the `unordered_set` or `unordered_multiset` classes instead of `set` or `multiset`.

To use the `unordered_set` or `unordered_multiset` classes, you must write the `#include <unordered_set>` directive in your program. In most cases, working with an `unordered_set` or `unordered_multiset` is similar to working with a `set` or `multiset`.





## Checkpoint

17.28 What are two differences between a `set` and a `vector`?

17.29 Write a statement that defines an empty `set` object named `aset`, that can hold strings.

17.30 Write a statement that defines a `set` object named `aset`, that can hold `int`s. The `set` should be initialized with these values: 10, 20, 30, 40

17.31 What happens when you use the `insert()` member function to insert a value into a `set`, and that value is already in the `set`?

17.32 What value does the `set` class's `count` member function return?

17.33 If you store objects of a class that you have written in a `set`, what must the class overload?

17.34 What is the difference between a `set` and a `multiset`?

17.35 In what two ways are the `unordered_set` and `unordered_multiset` different from the `set` and `multiset` classes?

## 17.6 Algorithms

### Concept:

Many commonly used algorithms are written as function templates in the STL.

The STL provides a number of algorithms, implemented as function templates, in the `<algorithm>` header file. These functions perform various operations on ranges of elements. A *range of elements* is a sequence of elements denoted by two iterators. The first iterator points to the first element in the range, and the second iterator points to the end of the range (the element to which the second iterator points is not included in the range). The algorithms can be organized in the following categories:

- **Min/max algorithms:**

Determine the smallest (min) and largest (max) values in a range of elements

- **Sorting algorithms:**

Sort a range of elements, or determine whether a range is sorted

- **Search algorithms:**

Perform various searching operations on a sorted range of elements

- **Read-only sequence algorithms:**

Iterate over a range of elements, performing various operations that do not modify the elements

- **Copying and moving algorithms:**

Use various techniques to copy or move ranges of elements.

- **Swapping algorithms:**

Swap values, ranges of elements, or the values pointed to by iterators

- **Replacement algorithms:**

Replace elements of a specified value

- **Removal algorithms:**

Remove elements

- **Reversal algorithms:**

Reverse the order of elements in a range

- **Fill algorithms:**

Fill the elements in a range with values

- **Rotation algorithms:**

Rotate the elements in a range with values

- **Shuffling algorithms:**

Shuffle the elements in a range

- **Set algorithms:**

Perform common mathematical set operations on a range of elements

- **Transformation algorithm:**

Iterate over ranges of elements, performing an operation using each element

- **Partition algorithms:**

Partition a range of elements into two groups

- **Merge algorithms:**

Merge ranges of elements

- **Permutation algorithms:**

Rearrange a range of elements into all of its different possible permutations

- **Heap algorithms:**

Create and work with a heap data structure

- **Lexicographical comparison algorithm:**

Makes a lexicographical comparison between two ranges of elements

At the time this was written, there are 85 function templates in the `<algorithm>` header file. For a summary of all of the STL algorithms, see Appendix H on the Computer Science Portal at [www.pearsonhighered.com/gaddis](http://www.pearsonhighered.com/gaddis). We will not discuss all of the STL algorithms in this chapter, but we will look at examples of some of the more interesting ones.

# Sorting and Searching Algorithms

The `<algorithm>` header file defines several function templates for sorting and searching. We will look at two of them: `sort()` and `binary_search()`. The `sort` function takes the following general format:

```
sort(iterator1, iterator2)
```

In the general format, `iterator1` and `iterator2` mark the beginning and end of a range of elements. The function sorts the range of elements in ascending order. The `binary_search()` function takes the following general format:

```
binary_search(iterator1, iterator2, value)
```

In the general format, the `iterator1` and `iterator2` arguments mark the beginning and end of a range of elements that are sorted in ascending order, and `value` is the value to search for. The function returns `true` if the `value` is found in the range of elements, or `false` otherwise. [Program 17-23](#) demonstrates both the `sort()` and `binary_search()` functions.

## Program 17-23


```
1 #include <iostream>
2 #include <vector>
3 #include <algorithm>
4 using namespace std;
5
6 int main()
7 {
8     int searchValue; // Value to search for
9
10    // Create a vector of unsorted integers.
11    vector<int> numbers = {10, 1, 9, 2, 8, 3, 7, 4, 6, 5};
12
13    // Sort the vector.
14    sort(numbers.begin(), numbers.end());
15
16    // Display the vector.
17    cout << "Here are the sorted values:\n";
18    for (auto element : numbers)
19        cout << element << " ";
20    cout << endl;
21
22    // Get the value to search for.
23    cout << "Enter a value to search for: ";
24    cin >> searchValue;
25
26    // Search for the value.
27    if (binary_search(numbers.begin(), numbers.end(), searchValue))
28        cout << "That value is in the vector.\n";
29    else
30        cout << "That value is not in the vector.\n";
31
32    return 0;
33 }
```

## Program Output

```
Here are the sorted values:  
1 2 3 4 5 6 7 8 9 10  
Enter a value to search for: 8  
That value is in the vector.
```

### Program Output

```
Here are the sorted values:  
1 2 3 4 5 6 7 8 9 10  
Enter a value to search for: 99  
That value is not in the vector.
```

The `sort()` and `binary_search()` functions use the `<` operator to compare elements. If the elements that you are sorting and searching contain your own class objects, be sure to overload the `<` operator. For example, recall the `Customer` class shown earlier in this chapter, in our discussion of the `map` class. (See the contents of the `Customer.h` file.) The `Customer` class holds two pieces of data about a customer: the customer number and the customer's name. The class also has an overloaded `<` operator that compares customer numbers. If we store objects of the `Customer` class in a sequence container, we can use the STL `sort()` and `binary_search()` functions to sort and search the container for an object containing a particular customer number. [Program 17-24](#)  demonstrates this.

## Program 17-24

```
1  #include <iostream>
2  #include <vector>
3  #include <algorithm>
4  #include "Customer.h"
5  using namespace std;
6
7  int main()
8  {
9      int searchValue; // Value to search for
10
11     // Create a vector of unsorted Customer objects.
12     vector<Customer> customers =
13         { Customer(1003, "Megan Cruz"),
14           Customer(1001, "Sarah Scott"),
15           Customer(1002, "Austin Hill")
16         };
17
18     // Sort the vector.
19     sort(customers.begin(), customers.end());
20
21     // Display the vector.
22     cout << "Here are the sorted customers:\n";
23     for (auto element : customers)
24     {
25         cout << element.getCustNumber() << " "
26             << element.getName() << endl;
27     }
28     cout << endl;
29
30     // Get the customer number to search for.
31     cout << "Enter a customer number to search for: ";
32     cin >> searchValue;
33
34     // Search for the customer number.
35     if (binary_search(customers.begin(), customers.end(),
36                      Customer(searchValue, "")))
37         cout << "That customer is in the vector.\n";
```

```
38     else
39         cout << "That customer is not in the vector.\n";
40
41     return 0;
42 }
```

### Program Output

```
Here are the sorted customers:
1001 Sarah Scott
1002 Austin Hill
1003 Megan Cruz

Enter a customer number to search for: 1001
That customer is in the vector.
```

### Program Output

```
Here are the sorted customers:
1001 Sarah Scott
1002 Austin Hill
1003 Megan Cruz

Enter a customer number to search for: 1009
That customer is not in the vector.
```

Let's take a closer look at the program:

- Lines 12 through 16 define a `vector` named `customers`, initialized with three `Customer` objects.
- Line 19 calls the `sort` function to sort the `vector`. Because the `Customer` class's overloaded `<` operator compares customer numbers, the objects in the vector will be sorted by customer number, in ascending order.
- The loop in lines 23 through 27 displays all of the vector's elements.
- Line 31 prompts the user to enter a customer number, and line 32 stores the user's input in the `searchValue` variable.
- Next, the program searches the vector for an object with the customer number entered by the user. Look carefully at the third argument we are passing to the `binary_search()` function. The expression



`Customer(searchValue, "")` constructs a temporary, nameless `Customer` object that has `searchValue`'s value as the customer number, and `""` as the customer name. (Because we are simply using this object to search for an element with a specified customer number, there is no need to provide a meaningful value for the customer name.) The `binary_search()` function will accept this `Customer` object as an argument, and it will search the specified range of elements for an object that has a matching customer number. (The `binary_search` function will use the `Customer` class's overloaded `<` operator to determine whether two objects are equal.) If a matching element is found, the function returns `true`. Otherwise, it returns `false`.

# Detecting Permutations

If a range has  $N$  elements, there are  $N!$  possible arrangements of those elements. Each arrangement is called a *permutation*. For example, suppose we have a vector with the following integer elements:

```
1, 2, 3
```


There are three elements in the vector, so there are six possible ways to rearrange the elements. The six possible permutations are:

```
1, 2, 3
1, 3, 2
2, 1, 3
2, 3, 1
3, 1, 2
3, 2, 1
```

The STL's `is_permutation()` function determines whether one range of elements is a permutation of another range of elements. Here is the function's general format:

```
is_permutation(iterator1, iterator2, iterator3)
```

In the general format, `iterator1` and `iterator2` mark the beginning and end of the first range of elements. The `iterator3` argument marks the beginning of the second range of elements, assumed to have the same number of elements as the first range. The function returns `true` if the second range is a permutation of the first range, or `false` otherwise.

**Program 17-25**  demonstrates the `is_permutation()` function. It uses the function to determine whether a set of numbers matches the winning lottery numbers.

## Program 17-25

```
1 #include <iostream>
2 #include <vector>
3 #include <algorithm>
4 using namespace std;
5
6 int main()
7 {
8     const int MAX = 5;           // Numbers in 1 lottery ticket
9     vector<int> winning(MAX);    // The winning numbers
10    vector<int> player(MAX);     // Numbers on a ticket
11
12    // Get the winning numbers.
13    cout << "Enter the " << MAX << " winning numbers:\n";
14    for (auto &element : winning)
15    {
16        cout << "> ";
17        cin >> element;
18    }
19
20    // Get the numbers purchased on a lottery ticket.
21    cout << "\nEnter your " << MAX << " lottery numbers:\n";
22    for (auto &element : player)
23    {
24        cout << "> ";
25        cin >> element;
26    }
27
28    // Check for a winner.
29    if (is_permutation(winning.begin(), winning.end(),
30                       player.begin()))
31        cout << "You won the lottery!\n";
32    else
33        cout << "Sorry, you did not win.\n";
34
35    return 0;
36 }
```

## Program Output

```
Enter the 5 winning numbers:
```

```
> 10
```

```
> 25
```

```
> 67
```

```
> 88
```

```
> 93
```

```
Enter your 5 lottery numbers:
```

```
> 25
```

```
> 15
```

```
> 62
```

```
> 93
```

```
> 88
```

```
Sorry, you did not win.
```

## Program Output

```
Enter the 5 winning numbers:
```

```
> 10
```

```
> 25
```

```
> 67
```

```
> 88
```

```
> 93
```

```
Enter your 5 lottery numbers:
```

```
> 67
```

```
> 10
```

```
> 93
```

```
> 88
```

```
> 25
```

```
You won the lottery!
```


# Plugging Your Own Functions into an Algorithm

When a C++ program is running, the executable code for each of the functions in that program is stored in memory. You can use the name of a function to get that function's address in memory, in the same way that you can use the name of an array to get that array's address in memory. This capability allows you to get a *function pointer*, which is a pointer to a function's executable code.

Many of the function templates in the STL are designed to accept function pointers as arguments. This allows you to “plug” one of your own functions into the algorithm. For example, here is the general format of the `for_each` function:

```
for_each(iterator1, iterator2, function)
```

In the general format, the `iterator1` and `iterator2` arguments mark the beginning and end of a range of elements. The `function` argument is the address of a function that accepts an element as its argument (Any value returned from `function` is ignored). The `for_each()` function iterates over the range of elements, passing each element as an argument to `function`.

**Program 17-26**  demonstrates the `for_each()` function. The program defines a function named `doubleNumber()`. The `doubleNumber()` function accepts a reference to an `int` as its argument, and it doubles the value of the argument. The program uses the `for_each()` function to double the value of every element in a `vector` of integers.

## Program 17-26

```
1 #include <iostream>
2 #include <vector>
3 #include <algorithm>
4 using namespace std;
5
6 // Function prototype
7 void doubleNumber(int &);
8
9 int main()
10 {
11     vector<int> numbers = { 1, 2, 3, 4, 5 };
12
13     // Display the numbers before doubling.
14     for (auto element : numbers)
15         cout << element << " ";
16     cout << endl;
17
18     // Double the value of each vector element.
19     for_each(numbers.begin(), numbers.end(), doubleNumber);
20
21     // Display the numbers before doubling.
22     for (auto element : numbers)
23         cout << element << " ";
24     cout << endl;
25
26     return 0;
27 }
28
29 /*******
30 // The doubleNumber function doubles the value of n. *
31 /*******
32 void doubleNumber(int &n)
33 {
34     n = n * 2;
35 }
```


## Program Output

```
1 2 3 4 5
2 4 6 8 10
```

Another example is the `count_if()` function. The general format of the `count_if()` function is:

```
count_if(iterator1, iterator2, function)
```

In the general format, the `iterator1` and `iterator2` arguments mark the beginning and end of a range of elements. The `function` argument is the address of a function that accepts an element as its argument, and returns either `true` or `false`. (The function should not make changes to the element.) The `count_if` function iterates over the range of elements, passing each element as an argument to `function`. The `count_if` function returns the number of elements for which `function` returns `true`.

**Program 17-27**  demonstrates the `count_if()` function. The program defines a function named `outOfRange()`. The `outOfRange()` function accepts an `int` as its argument, and it returns `true` if the argument is less than 0 or greater than 100. The program uses the `count_if()` function to determine the number of elements in a `vector` that are not within the range of 1 through 100.

## Program 17-27

```
1 #include <iostream>
2 #include <vector>
3 #include <algorithm>
4 using namespace std;
5
6 // Function prototype
7 bool outOfRange(int);
8
9 int main()
10 {
11     // Create a vector of ints.
12     vector<int> numbers = { 0, 99, 120, -33, 10, 8, -1, 101 };
13
14     // Get the number of elements that are < 0 or > 100.
15     int invalid = count_if(numbers.begin(), numbers.end(), outOfRange);
16
17     // Display the results.
18     cout << "There are " << invalid << " elements out of range.\n";
19     return 0;
20 }
21
22 //*****
23 // The outOfRange function returns true if n is out of range. *
24 //*****
25 bool outOfRange(int n)
26 {
27     // Constants for min and max values
28     const int MIN = 0, MAX = 100;
29
30     // Flag to hold the status
31     bool status;
32
33     // Determine whether n out of range.
34     if (n < MIN || n > MAX)
35         status = true;
36     else
37         status = false;
```



```
38  
39     return status;  
40 }
```

### Program Output

```
There are 4 elements out of range.
```

# Using the STL to Perform Set Operations

The STL provides a number of function templates for performing the basic set operations you probably learned in math class. [Table 17-14](#) summarizes these methods.

## Table 17-14 STL Algorithms to Perform Set Operations

The ranges of elements with which these member functions work can be stored in `set` containers, `vector`s, `array`s, or any other type of container that supports iterators. Keep in mind, however, the ranges of elements must be sorted in ascending order before you can use any of the functions in [Table 17-14](#) with them. For that reason, the `set` container is convenient because it automatically sorts its elements.

## *Finding the Union of Sets with the `set_union` Function*

The union of two sets is a set that contains all the elements of both sets, with no duplicates. For example, suppose `set1` contains the values 1, 2, 3, 4, and `set2` contains the values 3, 4, 5, 6. The union of `set1` and `set2` would be a set containing the values 1, 2, 3, 4, 5, 6.

You can call the STL algorithm function `set_union` to get the union of two sets. The function stores the union in a third container. [Program 17-28](#)  demonstrates how to use the function.

## Program 17-28

```
1 #include <iostream>
2 #include <set>
3 #include <algorithm>
4 #include <vector>
5 using namespace std;
6
7 int main()
8 {
9     // Create two sets.
10    set<int> set1 = {1, 2, 3, 4};
11    set<int> set2 = {3, 4, 5, 6};
12
13    // Create a vector to hold the union. The
14    // vector must be large enough to hold both sets.
15    vector<int> result(set1.size() + set2.size());
16
17    // Get the union of the sets. The result vector
18    // will hold the union, and iter will point to
19    // the end of the result vector.
20    auto iter = set_union(set1.begin(), set1.end(),
21                          set2.begin(), set2.end(),
22                          result.begin());
23
24    // Resize the result vector to remove unused elements.
25    result.resize(iter - result.begin());
26
27    // Display the result vector's elements
28    cout << "The union of the sets is:\n";
29    for (auto element : result)
30    {
31        cout << element << " ";
32    }
33    cout << endl;
34
35    return 0;
36 }
```

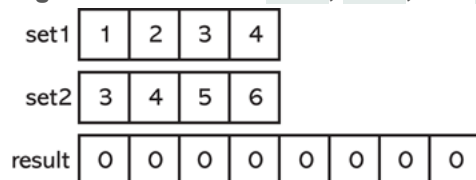
## Program Output

```
The union of the sets is:  
1 2 3 4 5 6
```

Let's take a closer look at [Program 17-28](#):

- Lines 10 and 11 define `set1` and `set2`, initialized with the values 1, 2, 3, 4, and 3, 4, 5, 6, respectively.
- Line 15 defines a `vector` named `result`. We will use the `vector` to hold the union of `set1` and `set2`. Notice the value we are passing to the `vector` constructor: `set1.size() + set2.size()`. This causes the `vector` to be large enough to hold both `set` s. (The `vector` elements will be initialized with 0.) [Figure 17-6](#) shows the state of `set1`, `set2`, and `result` at this point in the program.
- Line 18 defines an iterator that can be used with the `vector`. The name of the iterator is `iter`.
- Lines 20 through 22 call the `set_union` function. The function gets the union of `set1` and `set2`, and stores the union in the `result` vector. The function returns an iterator that is assigned to `iter`. The `iter` iterator points to the *end* of the range of elements in the union. [Figure 17-7](#) shows the state of `set1`, `set2`, `result`, and `iter` at this point in the program. (Notice the last two elements of the `result` vector are unused.)
- Line 25 resizes the `result` vector to remove the unused elements. [Figure 17-8](#) shows the state of `set1`, `set2`, `result`, and `iter` at this point in the program.
- Lines 28 through 36 display the program's output, which includes the contents of the `result` vector.

**Figure 17-6** State of `set1`, `set2`, and `result` after line 15 has executed



**Figure 17-7** State of `set1`, `set2`, `result`, and `iter` after lines 20 through 22 have executed

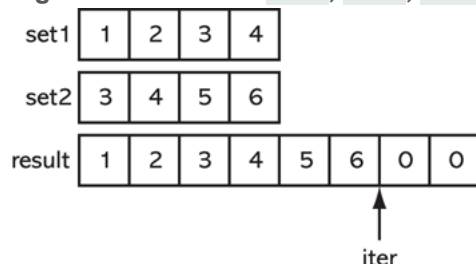
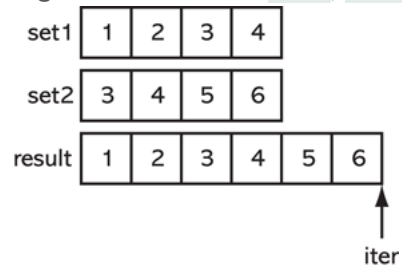



Figure 17-8 State of `set1`, `set2`, `result`, and `iter` after line 25 has executed



## *Finding the Intersection of Sets with the `set_intersection` Function*

The intersection of two sets is a set that contains only the elements that are found in both sets. For example, suppose `set1` contains the values 1, 2, 3, 4, and `set2` contains the values 3, 4, 5, 6. The intersection of `set1` and `set2` would be a set containing the values 3, 4.

You can call the STL algorithm function `set_intersection` to get the intersection of two sets. The function stores the intersection in a third container. [Program 17-29](#)  demonstrates how to use the function.

## Program 17-29

```
1  #include <iostream>
2  #include <set>
3  #include <algorithm>
4  #include <vector>
5  using namespace std;
6
7  int main()
8  {
9      // Create two sets.
10     set<int> set1 = {1, 2, 3, 4};
11     set<int> set2 = {3, 4, 5, 6};
12
13     // Create a vector to hold the intersection. The
14     // vector must be large enough to hold both sets.
15     vector<int> result(set1.size() + set2.size());
16
17     // Get the intersection of the sets. The result vector
18     // will hold the intersection, and iter will point to
19     // the end of the result vector.
20     auto iter = set_intersection(set1.begin(), set1.end(),
21                                 set2.begin(), set2.end(),
22                                 result.begin());
23
24     // Resize the result vector to remove unused elements.
25     result.resize(iter - result.begin());
26
27     // Display the result vector's elements
28     cout << "The intersection of the sets is:\n";
29     for (auto element : result)
30     {
31         cout << element << " ";
32     }
33     cout << endl;
34
35     return 0;
36 }
```



## Program Output


```
The intersection of the sets is:  
3 4
```

Let's take a closer look at [Program 17-29](#) :

- Lines 10 and 11 define `set1` and `set2`, initialized with the values 1, 2, 3, 4, and 3, 4, 5, 6, respectively.
- Line 15 defines a `vector` named `result`. We will use the `vector` to hold the intersection of `set1` and `set2`. Notice the value we are passing to the `vector` constructor: `set1.size() + set2.size()`. This causes the `vector` to be large enough to hold both `set`s. (The `vector` elements will be initialized with 0.)
- Line 18 defines an iterator that can be used with the `vector`. The name of the iterator is `iter`.
- Lines 20 through 22 call the `set_intersection` function. The function gets the intersection of `set1` and `set2`, and stores the intersection in the `result` vector. The function returns an iterator that is assigned to `iter`. The `iter` iterator points to the *end* of the range of elements in the intersection.
- Line 25 resizes the `result` vector to remove any unused elements.
- Lines 28 through 33 display the program's output, which includes the contents of the `result` vector.

## *Finding the Difference of Sets with the `set_difference` Function*

The difference of two sets is the set of elements that appear in the first set, but not the second set. For example, suppose `set1` contains the values 1, 2, 3, 4, and `set2` contains the values 3, 4, 5, 6. The difference of `set1` and `set2` would be a set containing the values 1, 2.


You can call the STL algorithm function `set_difference` to get the difference of two sets. The function stores the difference in a third container. [Program 17-30](#)  demonstrates how to use the function.

## Program 17-30

```
1  #include <iostream>
2  #include <set>
3  #include <algorithm>
4  #include <vector>
5  using namespace std;
6
7  int main()
8  {
9      // Create two sets.
10     set<int> set1 = {1, 2, 3, 4};
11     set<int> set2 = {3, 4, 5, 6};
12
13     // Create a vector to hold the difference. The
14     // vector must be large enough to hold both sets.
15     vector<int> result(set1.size() + set2.size());
16
17     // Get the difference of the sets. The result vector
18     // will hold the difference, and iter will point to
19     // the end of the result vector.
20     auto iter = set_difference(set1.begin(), set1.end(),
21                               set2.begin(), set2.end(),
22                               result.begin());
23
24     // Resize the result vector to remove unused elements.
25     result.resize(iter - result.begin());
26
27     // Display the result vector's elements
28     cout << "The difference of set1 and set2 is:\n";
29     for (auto element : result)
30     {
31         cout << element << " ";
32     }
33     cout << endl;
34
35     return 0;
36 }
```

## Program Output


```
The difference of set1 and set2 is:  
1 2
```

Let's take a closer look at [Program 17-30](#) :

- Lines 10 and 11 define `set1` and `set2`, initialized with the values 1, 2, 3, 4, and 3, 4, 5, 6, respectively.
- Line 15 defines a `vector` named `result`. We will use the `vector` to hold the difference of `set1` and `set2`. Notice the value we are passing to the `vector` constructor: `set1.size() + set2.size()`. This causes the `vector` to be large enough to hold both `set` s. (The `vector` elements will be initialized with 0.)
- Line 18 defines an iterator that can be used with the `vector`. The name of the iterator is `iter`.
- Lines 20 through 22 call the `set_difference` function. The function gets the difference of `set1` and `set2`, and stores the difference in the `result` vector. The function returns an iterator that is assigned to `iter`. The `iter` iterator points to the *end* of the range of elements in the difference.
- Line 25 resizes the `result` vector to remove any unused elements.
- Lines 28 through 33 display the program's output, which includes the contents of the `result` vector.

## *Finding the Symmetric Difference of Sets with the `set_symmetric_difference` Function*

The symmetric difference of two sets is the set of elements that are in either set, but not in both. For example, suppose `set1` contains the values 1, 2, 3, 4, and `set2` contains the values 3, 4, 5, 6. The symmetric difference of `set1` and `set2` would be a set containing the values 1, 2, 5, 6.


You can call the STL algorithm function `set_symmetric_difference` to get the symmetric difference of two sets. The function stores the symmetric difference in a third container. [Program 17-31](#)  demonstrates how to use the function.

## Program 17-31

```
1  #include <iostream>
2  #include <set>
3  #include <algorithm>
4  #include <vector>
5  using namespace std;
6
7  int main()
8  {
9      // Create two sets.
10     set<int> set1 = {1, 2, 3, 4};
11     set<int> set2 = {3, 4, 5, 6};
12
13     // Create a vector to hold the symmetric difference.
14     // The vector must be large enough to hold both sets.
15     vector<int> result(set1.size() + set2.size());
16
17     // Get the symmetric difference of the sets. The result
18     // vector will hold the symmetric difference, and iter
19     // will point to the end of the result vector.
20     auto iter = set_symmetric_difference(set1.begin(), set1.end(),
21                                         set2.begin(), set2.end(),
22                                         result.begin());
23
24     // Resize the result vector to remove unused elements.
25     result.resize(iter - result.begin());
26
27     // Display the result vector's elements
28     cout << "The symmetric difference of the sets is:\n";
29     for (auto element : result)
30     {
31         cout << element << " ";
32     }
33     cout << endl;
34
35     return 0;
36 }
```

## Program Output

```
The symmetric difference of the sets is:  
1 2 5 6
```

Let's take a closer look at [Program 17-31](#) :

- Lines 10 and 11 define `set1` and `set2`, initialized with the values 1, 2, 3, 4, and 3, 4, 5, 6, respectively.
- Line 15 defines a `vector` named `result`. We will use the `vector` to hold the difference of `set1` and `set2`. Notice the value we are passing to the `vector` constructor: `set1.size() + set2.size()`. This causes the `vector` to be large enough to hold both `set` s. (The `vector` elements will be initialized with 0.)
- Line 18 defines an iterator that can be used with the `vector`. The name of the iterator is `iter`.
- Lines 20 through 22 call the `set_symmetric_difference` function. The function gets the symmetric difference of `set1` and `set2`, and stores the symmetric difference in the `result` vector. The function returns an iterator that is assigned to `iter`. The `iter` iterator points to the *end* of the range of elements in the symmetric difference.
- Line 25 resizes the `result` vector to remove any unused elements.
- Lines 28 through 33 display the program's output, which includes the contents of the `result` vector.

## Finding Subsets

Suppose you have two sets and one of those sets includes all of the elements of the other set. For example, suppose `set1` contains the values 1, 2, 3, 4, and `set2` contains the values 2, 3. In this example, `set1` contains all of the elements of `set2`, which means that `set2` is a *subset* of `set1`.

You can call the STL function `includes` to determine whether one set includes all of the elements of another set. You use iterators to pass two sorted ranges of elements to the `includes` function, and the function returns `true` if the first range includes all of the elements in the second range. Otherwise, the function returns `false`. [Program 17-32](#) demonstrates how to use the function. The program determines whether the elements in `set1` include all of the elements in `set2`.



## Program 17-32

```
1 #include <iostream>
2 #include <set>
3 #include <algorithm>
4 using namespace std;
5
6 int main()
7 {
8     // Create two sets.
9     set<int> set1 = {1, 2, 3, 4};
10    set<int> set2 = {2, 3};
11
12    // Determine whether set1 includes the
13    // elements of set2.
14    if (includes(set1.begin(), set1.end(),
15                set2.begin(), set2.end()))
16    {
17        cout << "set2 is a subset of set1.\n";
18    }
19    else
20    {
21        cout << "set2 is NOT a subset of set1.\n";
22    }
23
24    return 0;
25 }
```

### Program Output

```
set2 is a subset of set1.
```



## In the Spotlight:

### Set Operations

In this section, you will look at [Program 17-33](#), which demonstrates various set operations. The program creates two sets: one that holds the names of students on the baseball team, and another that holds the names of students on the basketball team. The program then performs the following operations:

- It finds the intersection of the sets to display the names of students who play both sports.
- It finds the union of the sets to display the names of students who play either sport.
- It finds the difference of the `baseball` and `basketball` sets to display the names of students who play baseball but not basketball.
- It finds the difference of the `basketball` and `baseball` (`basketball - baseball`) sets to display the names of students who play basketball but not baseball. It also finds the difference of the `baseball` and `basketball` (`baseball - basketball`) sets to display the names of students who play baseball but not basketball.
- It finds the symmetric difference of the `basketball` and `baseball` sets to display the names of students who play one sport but not both.

## Program 17-33

```
1 #include <iostream>
2 #include <string>
3 #include <algorithm>
4 #include <set>
5 #include <vector>
6 using namespace std;
7
8 // Function prototypes
9 void displaySet(set<string>);
10 void displayIntersection(set<string>, set<string>);
11 void displayUnion(set<string>, set<string>);
12 void displayDifference(set<string>, set<string>);
13 void displaySymmetricDifference(set<string>, set<string>);
14
15 int main()
16 {
17     // Create sets for the baseball & basketball teams.
18     set<string> baseball = {"Jodi", "Carmen", "Aida", "Alicia"};
19     set<string> basketball = {"Eva", "Carmen", "Alicia", "Sarah"};
20
21     // Display the elements of the baseball set.
22     cout << "The following students are on the baseball team:\n";
23     displaySet(baseball);
24
25     // Display the elements of the basketball set.
26     cout << "\n\nThe following students are on the basketball team:\n";
27     displaySet(basketball);
28
29     // Display the intersection of the two sets.
30     cout << "\n\nThe following students play both sports:\n";
31     displayIntersection(baseball, basketball);
32
33     // Display the union of the two sets.
34     cout << "\n\nThe following students play either sport:\n";
35     displayUnion(baseball, basketball);
36
```

```

37 // Display the difference of baseball and basketball.
38 cout << "\n\nThe following students play baseball, "
39     << "but not basketball:\n";
40 displayDifference(baseball, basketball);
41
42 // Display the difference of basketball and baseball.
43 cout << "\n\nThe following students play basketball, "
44     << "but not baseball:\n";
45 displayDifference(basketball, baseball);
46
47 // Display the symmetric difference of the two sets.
48 cout << "\n\nThe following students play one sport, "
49     << "but not both:\n";
50 displaySymmetricDifference(basketball, baseball);
51 return 0;
52 }
53
54 // The displaySet function displays the contents of a set<string>.
55 void displaySet(set<string> s)
56 {
57     for (auto element : s)
58         cout << element << " ";
59 }
60
61 // The displayIntersection function displays the intersection
62 // of two set<string> objects.
63 void displayIntersection(set<string> set1, set<string> set2)
64 {
65     // Create a vector to hold the intersection.
66     vector<string> result(set1.size() + set2.size());
67
68     // Get the intersection of the sets.
69     auto iter = set_intersection(set1.begin(), set1.end(),
70                                 set2.begin(), set2.end(),
71                                 result.begin());
72
73     // Resize the result vector to remove unused elements.
74     result.resize(iter - result.begin());
75
76     // Display the result vector's elements
77     for (auto element : result)

```

```

78     {
79         cout << element << " ";
80     }
81 }
82
83 // The displayUnion function displays the union of two
84 // set<string> objects.
85 void displayUnion(set<string> set1, set<string> set2)
86 {
87     // Create a vector to hold the union.
88     vector<string> result(set1.size() + set2.size());
89
90     // Get the union of the sets.
91     auto iter = set_union(set1.begin(), set1.end(),
92                          set2.begin(), set2.end(),
93                          result.begin());
94
95     // Resize the result vector to remove unused elements.
96     result.resize(iter - result.begin());
97
98     // Display the result vector's elements
99     for (auto element : result)
100    {
101        cout << element << " ";
102    }
103 }
104
105 // The displayDifference function displays the difference
106 // of two set<string> objects.
107 void displayDifference(set<string> set1, set<string> set2)
108 {
109     // Create a vector to hold the union.
110     vector<string> result(set1.size() + set2.size());
111
112     // Get the difference of the sets.
113     auto iter = set_difference(set1.begin(), set1.end(),
114                               set2.begin(), set2.end(),
115                               result.begin());
116
117     // Resize the result vector to remove unused elements.
118     result.resize(iter - result.begin());

```

```

119
120 // Display the result vector's elements
121 for (auto element : result)
122 {
123     cout << element << " ";
124 }
125 }
126
127 // The displaySymmetricDifference function displays the
128 // symmetric difference of two set<string> objects.
129 void displaySymmetricDifference(set<string> set1, set<string> set2)
130 {
131     // Create a vector to hold the union.
132     vector<string> result(set1.size() + set2.size());
133
134     // Get the symmetric difference of the sets.
135     auto iter = set_symmetric_difference(set1.begin(), set1.end(),
136                                         set2.begin(), set2.end(),
137                                         result.begin());
138
139     // Resize the result vector to remove unused elements.
140     result.resize(iter - result.begin());
141
142     // Display the result vector's elements
143     for (auto element : result)
144     {
145         cout << element << " ";
146     }
147 }

```

## Program Output

The following students are on the baseball team:

Aida Alicia Carmen Jodi

The following students are on the basketball team:

Alicia Carmen Eva Sarah

The following students play both sports:

Alicia Carmen

The following students play either sport:

Aida Alicia Carmen Eva Jodi Sarah

The following students play baseball, but not basketball:

Aida Jodi

The following students play basketball, but not baseball:

Eva Sarah

The following students play one sport, but not both:

Aida Eva Jodi Sarah



## Checkpoint

17.36 When a range of elements is denoted by two iterators, to what does the first iterator point? To what does the second iterator point?

17.37 What value will be stored in `v[0]` after the following code executes?

```
vector<int> v = {8, 4, 6, 1, 9}; sort(v.begin(), v.end());
```

17.38 What must you do to a range of elements before searching it with the `binary_search()` function?

17.39 If the elements that you are sorting with the `sort()` function contain your own class objects, you must be sure that the class overloads what operator?

17.40 If the elements that you are searching with the `binary_search()` function contain your own class objects, you must be sure that the class overloads what operator?

17.41 What is a function pointer?

17.42 Assume `vect` is a vector that contains 100 `int` elements, and the following statement appears in a program:

```
for_each(vect.begin(), vect.end(), myFunction);
```

Without knowing anything else about the program, answer the following questions:

- A. What is `myFunction`?
- B. How many arguments does `myFunction` accept? What are the data type(s) of the argument(s)?
- C. What value does `myFunction` return?
- D. How many times will the statement cause `myFunction` to be called?



# 17.7 Introduction to Function Objects and Lambda Expressions

## Concept:

A function object is an object of a class that overloads the function call operator. Function objects behave just like functions, and can be passed as parameters to other functions. A lambda expression is a convenient way of creating a function object.



## Function Objects and Lambda Expressions


A *function object*, also known as a *functor*, is an object that acts like a function. Function objects can be called, just like regular functions.

They can accept arguments, and they can return values. To create a function object, you write a class that overloads the parentheses `()` operator, which is also known as the *function call operator*. Let's look at a simple example, the `Sum` class.

## Contents of `Sum.h`

```
1  #ifndef SUM_H
2  #define SUM_H
3
4  class Sum
5  {
6  public:
7      int operator()(int a, int b)
8      { return a + b; }
9  };
10 #endif
```

The `Sum` class has one member function: the `operator()` function. When you write an `operator()` function, the function can have as many parameter variables as necessary. Notice in the `Sum` class, the `operator()` function has two `int` parameter variables: `a` and `b`.

Also, notice in the `Sum` class the `operator()` function returns an `int`. The value it returns is the sum of `a` and `b`. **Program 17-34**  demonstrates the `Sum` class.

## Program 17-34

```
1  #include <iostream>
2  #include "Sum.h"
3  using namespace std;
4
5  int main()
6  {
7      // Local variables
8      int x = 10;
9      int y = 2;
10     int z = 0;
11
12     // Create a Sum object.
13     Sum sum;
14
15     // Call the sum function object.
16     z = sum(x, y);
17
18     // Display the result.
19     cout << z << endl;
20
21     return 0;
22 }
```

## Program Output

```
12
```

Let's take a closer look at [Program 17-34](#) :

- Lines 8 through 10 define three local `int` variables: `x`, `y`, and `z`.
- Line 13 creates an instance of the `Sum` class. The object's name is `sum`.
- Line 16 calls the `sum` object, as if it were a function. The statement passes `x` and `y` as arguments, and assigns the return value to the `z` variable.
- Line 19 displays the `z` variable.


In the previous section on STL algorithms, you saw examples of STL function templates that accept function pointers as arguments, allowing you to plug one of your own functions into the algorithm. If you prefer, you can pass a function object instead of a function pointer to any of these STL algorithms.

Let's look at an example, using the `count_if()` function. Recall the `count_if()` function iterates over a range of elements, passing each element as an argument to a function that you provide. The

function you provide must accept one argument, and return either `true` or `false`. You can provide the function as either a function pointer, or a function object. The `count_if` function returns the number of elements for which `function` returns `true`. We will use a function object along with the `count_if()` function to count the number of even numbers that appear in a `vector`. Our function object will be an instance of the `IsEven` class, shown here:

## Contents of `IsEven.h`

```
1 #ifndef IS_EVEN_H
2 #define IS_EVEN_H
3
4 class IsEven
5 {
6 public:
7     bool operator()(int x)
8     { return x % 2 == 0; }
9 };
10 #endif
```

The `IsEven` class has one member function: the `operator()` function. The `operator()` function has one `int` parameter variable, `x`. The function returns `true` if `x` is an even number, or `false` otherwise. **Program 17-35**  creates an instance the `IsEven` class, and uses it as a function object with the `count_if()` function.

## Program 17-35

```
1  #include <iostream>
2  #include <vector>
3  #include <algorithm>
4  #include "IsEven.h"
5  using namespace std;
6
7  int main()
8  {
9      // Create a vector of ints.
10     vector<int> v = { 1, 2, 3, 4, 5, 6, 7, 8 };
11
12     // Create an instance of the IsEven class.
13     IsEven isNumberEven;
14
15     // Get the number of elements that even.
16     int evenNums = count_if(v.begin(), v.end(),
17                             isNumberEven);
18
19     // Display the results.
20     cout << "The vector contains " << evenNums
21     << " even numbers.\n";
```



```
20     return 0;  
21 }
```

## Program Output

```
The vector contains 4 even numbers.
```

# Constructing an Anonymous Function Object

In line 13 of [Program 17-35](#), we created an instance of the `IsEven` class, and we named it `isNumberEven`. Then, in line 16 we passed the object to the `count_if()` function. Function objects can be called at the point of their creation, however, without ever being given a name. For example, the following code creates an `IsEven` function object and calls it with the argument 2, without ever giving the function object a name:

```
if (IsEven(2))
    cout << "The number is even.\n";
else
    cout << "The number is not even.\n";
```

Objects that are created and used without being given a name are said to be *anonymous*. [Program 17-36](#) is similar to [Program 17-35](#), except that an anonymous instance of the `IsEven` class is passed to the `count_if()` function.

## Program 17-36

```
1  #include <iostream>
2  #include <vector>
3  #include <algorithm>
4  #include "IsEven.h"
5  using namespace std;
6
7  int main()
8  {
9      // Create a vector of ints.
10     vector<int> v = { 1, 2, 3, 4, 5, 6, 7, 8 };
11
12     // Get the number of elements that even.
13     int evenNums = count_if(v.begin(), v.end(),
14                             IsEven());
14
15     // Display the results.
16     cout << "The vector contains " << evenNums
17          << " even numbers.\n";
17     return 0;
18 }
```

## Program Output

```
The vector contains 4 even numbers.
```

## Predicate Terminology

A function or function object that returns a Boolean value is called a *predicate*. A predicate that takes only one argument is called a *unary predicate*. (An instance of the `IsEven` class, previously shown, would be a unary predicate.) A predicate that takes two arguments is called a *binary predicate*. It is important that you are familiar with this terminology because it is used in much of the available C++ documentation and literature.

# Lambda Expressions

**11** A *lambda expression* is a compact way of creating a function object without having to write a class declaration. It is an expression that contains only the logic of the object's `operator()` member function. When the compiler encounters a lambda expression, it automatically generates a function object in memory, using the code that you provide in the lambda expression for the `operator()` member function.

Typically, a lambda expression takes the following general format:

```
[ ] (parameter list) { function body }
```

The `[ ]` at the beginning of the expression is known as the *lambda introducer*. It marks the beginning of a lambda expression. The `parameter list` is a list of parameter declarations for the function object's `operator()` member function, and the `function body` is the code that should be the body of the object's `operator()` member function.

For example, the lambda expression for a function object that computes the sum of two integers is:

```
[](int a, int b) { return x + y; }
```

And, the lambda expression for a function object that determines whether an integer is even is:

```
[](int x) { return x % 2 == 0; }
```

As another example, the lambda expression that takes an integer as input and prints the square of that integer is written like this:

```
[](int a) { cout << a * a << " "; }
```



### **Note:**

Optionally, a *capture list* can appear inside the brackets `[]` of a lambda expression. A capture list is a list of variables in the surrounding scope of the lambda expression that can be accessed from the lambda's function body.

When you call a lambda expression, you write a list of arguments, enclosed in parentheses, right after the expression. For example, the following code snippet displays 7, which is the sum of the variables `x` and `y`:

```
int x = 2;
int y = 5;
cout << [](int a, int b) {return a + b;}(x, y) << endl;
```

The following code segment counts the even numbers in a `vector`, in the manner of [Program 17-36](#). However, it uses a lambda expression in place of the `IsEven()` function object as the third argument to the `count_if()` function.

```
// Create a vector of ints.
vector<int> v = { 1, 2, 3, 4, 5, 6, 7, 8 };
// Get the number of elements that are even.
int evenNums = count_if(v.begin(), v.end(), [](int x) {return x
% 2 == 0;});
// Display the results.
cout << "The vector contains " << evenNums << " even
numbers.\n";
```

Because lambda expressions generate function objects, you can assign a lambda expression to a variable of a suitable type then call



it through the variable's name. For example, the lambda expression shown in the following code gives us a function object that adds two integers. The function object is assigned to a variable named `sum`:

```
auto sum = [](int a, int b) {return a + b;};
```

Once the statement has executed, we can use the `sum` variable to call the function object, as shown here:

```
int x = 2;  
int y = 5;  
int z = sum(x, y);
```

After this code has executed, the variable `z` will be assigned 7.

**Program 17-37**  shows another example. It is similar to **Program 17-36** , except that a lambda expression (which determines whether a value is even) is assigned to a variable named `isEven`, and that variable is passed as the third argument to the `count_if()` function.



## Program 17-37

```
1  #include <iostream>
2  #include <vector>
3  #include <algorithm>
4  using namespace std;
5
6  int main()
7  {
8      // Create a vector of ints.
9      vector<int> v = { 1, 2, 3, 4, 5, 6, 7, 8 };
10
11     // Use a lambda expression to create a
12     function object.
13     auto isEven = [](int x) { return x % 2 ==
14     0; };
15
16     // Get the number of elements that even.
17     int evenNums = count_if(v.begin(), v.end(),
18     isEven);
19
20     // Display the results.
21     cout << "The vector contains " << evenNums
22     << " even numbers.\n";
```

```
19     return 0;  
20 }
```

## Program Output

```
The vector contains 4 even numbers.
```

# Functional Classes in the STL

Function objects are so useful the C++ library defines a number of classes that you can instantiate to create function objects in your program. To use these classes, you must `#include` the `<functional>` header file. [Table 17-15](#) lists those that can be used to compare objects, but you can find information on many more in various resources online.

## Table 17-15 STL Function Object Classes

For example, the STL `sort` function normally sorts the elements in a range in ascending order. This is because the `sort` function, by default, uses the `<` operator to compare elements. But what if you want to use the function to sort a range of elements in descending order? All you have to do is make the function use the `>` operator instead.

As it turns out, the `sort` function takes a comparison function as an optional third argument. The argument can be a function pointer or a function object. The function must accept two arguments (of the same type as the range elements), and must return a Boolean value. When you pass a comparison function as the third argument to the `sort` function, the `sort` function will use the comparison function instead of the `<` operator to compare range elements. To make the sort function use the `>` operator, you can pass an instance of the `greater<T>` class as the comparison function. [Program 17-38](#)

demonstrates how this can be done to sort a `vector` in descending order.

## Program 17-38

```
1  #include <iostream>
2  #include <vector>
3  #include <functional>
4  #include <algorithm>
5  using namespace std;
6
7  int main()
8  {
9      // Create an unsorted vector of ints.
10     vector<int> v = {8, 1, 7, 2, 6, 3, 5, 4};
11
12     // Display the vector contents.
13     cout << "Original order:\n";
14     for (auto element : v)
15         cout << element << " ";
16
17     // Sort the vector in ascending order.
18     sort(v.begin(), v.end());
19
20     // Display the vector contents again.
21     cout << "\nAscending order:\n";
22     for (auto element : v)
23         cout << element << " ";
```

```
24
25     // Sort the vector in descending order.
26     sort(v.begin(), v.end(), greater<int>());
27
28     // Display the vector contents again.
29     cout << "\nDescending order:\n";
30     for (auto element : v)
31         cout << element << " ";
32     cout << endl;
33
34     return 0;
35 }
```

## Program Output

```
Original order:
8 1 7 2 6 3 5 4
Ascending order:
1 2 3 4 5 6 7 8
Descending order:
8 7 6 5 4 3 2 1
```



## *Checkpoint*

17.43 What is a function object?

17.44 Which operator must be overloaded in a class before the class can be used to create function objects?

17.45 What is an anonymous function object?

17.46 What is a predicate?

17.47 What is a unary predicate?

17.48 What is a binary predicate?

17.49 What is a lambda expression?

# Review Questions and Exercises

## Short Answer

1. What two emplacement member functions are provided by the `vector` class? How are these member functions different from the `insert()` and `push_back()` member functions?
2. What is the difference between the `vector` class's `size()` member function and the `capacity()` member function?
3. If you want to store objects of a class that you have written as values in a `map`, what requirement must the class meet?
4. If you want to store objects of a class that you have written as keys in a `map`, what requirement must the class meet?
5. What is the difference between a `map` and an `unordered_map`?
6. What is the difference between a `map` and a `multimap`?
7. What happens if you use the `insert()` member function to insert a value into a `set`, and that value already exists in the `set`?
8. If you want to store objects of a class that you have written as keys in a `set`, what requirement must the class meet?
9. What is the difference between a `set` and a `multiset`?



10. How does the behavior of the `count()` member function differ between the `set` class and the `multiset` class?
11. How does the behavior of the `equal_range()` member function differ between the `set` class and the `multiset` class?
12. What are two differences between the `set` and `unordered_set` classes?
13. When using one of the STL algorithm function templates, you typically work with a range of elements that are denoted by two iterators, to what does the first iterator point? To what does the second iterator point?
14. You have written a class, and you plan to store objects of that class in a `vector`. If you plan to use the `sort()` and/or `binary_search()` functions on the vector's elements, what operator must the class overload?
15. What is a function object?
16. If you want to create function objects from a class, what must the class overload?
17. What is an anonymous function object?
18. What is a lambda expression?

# Fill-in-the-Blank

19. There are two types of container classes in the STL: \_\_\_\_\_ and \_\_\_\_\_.
20. A(n) \_\_\_\_\_ container organizes data in a sequential fashion similar to an array.
21. A container \_\_\_\_\_ class is not itself a container, but a class that adapts a container to a specific use.
22. A(n) \_\_\_\_\_ container stores its data in a nonsequential way that makes it faster to locate elements.
23. \_\_\_\_\_ are pointer-like objects used to access data stored in a container.
24. Each element that is stored in a `map` has two parts: a \_\_\_\_\_ and a \_\_\_\_\_.
25. \_\_\_\_\_ is a map container that allows duplicate keys.
26. The \_\_\_\_\_ class is an associative container that stores a collection of unique, sorted values.
27. The \_\_\_\_\_ header file defines several function templates that implement useful algorithms.
28. A \_\_\_\_\_ is a pointer to a function's executable code.
29. A \_\_\_\_\_ object is an object that can be called, like a function.
30. A \_\_\_\_\_ is a function or function object that returns a Boolean value.
31. A \_\_\_\_\_ is a predicate that takes one argument.
32. A \_\_\_\_\_ is a predicate that takes two arguments.

33. A \_\_\_\_\_ is a compact way of creating a function object without having to write a class declaration.

# True or False

34. T F The `array` class is a fixed-size container.
35. T F The `vector` class is a fixed-size container.
36. T F You use the `*` operator to dereference an iterator.
37. T F You can use the `++` operator to increment an iterator.
38. T F A container's `end()` member function returns an iterator pointing to the last element in the container.
39. T F A container's `rbegin()` member function returns a reverse iterator pointing to the first element in a container.
40. T F You do not have to declare the size of a `vector` when you define it.
41. T F A `vector` uses an array internally to store its elements.
42. T F A `map` is a sequence container.
43. T F You can store duplicate keys in a map container.
44. T F The `multimap` class's `erase()` member function erases only one element at a time. If you want to erase multiple elements that all have the same key, you will have to call the `erase()` member function multiple times.
45. T F All the elements in a `set` must be unique.
46. T F The elements in a `set` are sorted in ascending order.
47. T F If the same value appears more than once in the initialization list of a `set` definition, an exception will occur at runtime.
48. T F The `unordered_set` container has better performance than the `set` container.

49. T F If two iterators denote a range of elements that will be processed by an STL algorithm function, the element pointed to by the second iterator is not included in the range.
50. T F You must sort a range of elements before searching it with the `binary_search()` function.
51. T F Any class that will be used to create function objects must overload the `operator[]` member function.
52. T F Writing a lambda expression usually requires more code than writing a function object's class declaration and then instantiating the class.
53. T F You can assign a lambda expression to a variable, and then use the variable to call the lambda expression's function object.

# Algorithm Workbench

54. Write a statement that defines an `array` object named `numbers` that can hold ten elements of the `double` data type.
55. Write a statement that defines an iterator that can be used with the `array` object that you defined in question 54. The iterator's name should be `it`.
56. Write a statement that defines a `vector` named `numbers` that can hold elements of the `int` data type. Initialize the `vector` with the values 10, 20, 30, 40, and 50.
57. The following statement defines a `vector` of `int`s named `v`. Write a statement that defines another vector, named `v2`, which is a copy of `v`.

```
vector<int> v = {1, 2, 3, 4, 5};
```

58. Write a range-based `for` loop that displays all of the elements of the `vector` that you defined in question 56.
59. Write a `for` loop that uses an iterator to display all of the elements of the `vector` that you defined in question 56.
60. The following code defines a `vector` and an iterator. Rewrite the statement that defines the iterator so it uses the `auto` keyword.

```
vector<string> strv = {"one", "two", "three"};
```

```
vector<string>::iterator it = strv.begin();
```

61. The following statement defines a `vector` of `int`s named `v`. Write a statement that defines a `const_iterator` named

`cit`, and initializes it to point to the first element in `v`.

```
vector<int> v = {1, 2, 3, 4, 5};
```

62. The following statement defines a `vector` of `ints` named `v`. The `vector`'s initial contents are: 1, 2, 3, 4, 5. Write code to insert the value 999 into the `vector`, so its contents are: 1, 2, 999, 3, 4, 5.

```
vector<int> v = {1, 2, 3, 4, 5};
```

63. Write a statement that defines a `map` named `food`. The keys should be `strings`, and the values should be `ints`.

64. Suppose a program defines a map as follows:

```
map<int, string> customers;
```

Write statements that use the `map` class's `emplace` member function to insert the following elements:

```
9001, "Jen Williams"
```

```
9002, "Frank Smith"
```

```
9003, "Geri Rose"
```

65. Look at the following `vector` definition:

```
vector<int> v = {7, 2, 1, 6, 4, 3, 5};
```

Write code that displays a message indicating whether the value 6 is found in the `vector`. Use the STL

`binary_search()` algorithm to search the `vector` for the value 6.

66. Write a declaration for a class named `Display`. The class should be written in such a way that it can be used to create a

function object. A function object created from the class should accept an `int` argument, and display that argument on the screen.

67. Write code that does the following:

- Uses a lambda expression that accepts two `int` arguments, `a` and `b`, and returns the value of `a * b`.
- Assigns the lambda expression to a variable named `multiply`.
- Uses the `multiply` variable to call the lambda expression, passing the values 2 and 10 as arguments. The result should be assigned to an `int` variable named `product`.



# Find the Errors

Each of the following code snippets has errors. Find as many as you can.

68. `// This code has an error.`

```
array<int, 5> a;  
a[5] = 99;
```

69. `// This code has an error.`

```
vector<string> strv = {"one", "two", "three"};  
vector<string>::iterator it = strv.cbegin();
```

70. `// This code has an error.`

```
vector<int> numbers(10);  
for (int index = 0; index < numbers.length();  
index++)  
numbers[index] = index;
```

71. `// This code has an error.`

```
vector<int> numbers = {1, 2, 3};  
numbers.insert(99);
```

72. `// This code has an error.`

```
map<string, string> contacts;  
contacts.insert("Beth Young", "555-1212");
```

73. `// This code has an error.`

```
multimap<string, string> phonebook;  
phonebook["Megan"] = "555-1212";
```

74. `// This code has an error.`

```
vector<int> v = {6, 5, 4, 2, 3, 1};  
sort(v);  
if (binary_search(v, 1))  
    cout << "The value 1 is found in the vector.\n";  
else  
    cout << "The value 1 is NOT found in the vector.\n";
```

75. `// This code has an error.`

```
auto sum = () [int a, int b] { return a + b; };
```

# Programming Challenges

## 1. Unique Words

Write a program that opens a specified text file then displays a list of all the unique words found in the file.

*Hint: Store each word as an element of a set.*

## 2. Course Information



### The Course Information Problem

Write a program that creates a `map` containing course numbers and the room numbers of the rooms where the courses meet. The map should have the following key–value pairs:

The program should also create a `map` containing course numbers and the names of the instructors that teach each course. The map should have the following key–value pairs:

The program should also create a `map` containing course numbers and the meeting times of each course. The map should have the following key–value pairs:

The program should let the user enter a course number, then it should display the course’s room number, instructor, and meeting time.

## 3. Capital Quiz

Write a program that creates a `map` containing the U.S. states as keys, and their capitals as values. (Use the Internet to get a list of the states and their capitals.) The program should then randomly quiz the user by displaying the name of a state and ask the user to enter that state’s capital. The program should keep a count of the number of correct and incorrect responses. (As an alternative to the U.S. states, the program can use the names of countries and their capitals.)

## 4. File Encryption and Decryption

Write a program that uses a `map` to assign “codes” to each letter of the alphabet. For example:

```
map<char, char> codes =  
{ {'A', '%'}, {'a', '9'}, {'B', '@'}, {'b', '#'}, etc ...};
```

Using this example, the letter ‘A’ would be assigned the symbol %, the letter ‘a’ would be assigned the number 9, the letter ‘B’ would be assigned the symbol @, and so forth. The program should open a specified text file, read its contents, then use the map to write an encrypted version of the file’s contents to a second file. Each character in the second file should contain the

code for the corresponding character in the first file. Write a second program that opens an encrypted file and displays its decrypted contents on the screen.

## 5. Text File Analysis

Write a program that reads the contents of two text files and compares them in the following ways:

- It should display a list of all the unique words contained in both files.
- It should display a list of the words that appears in both files.
- It should display a list of the words that appears in the first file, but not the second.
- It should display a list of the words that appears in the second file, but not the first.
- It should display a list of the words that appears in either the first or second file, but not in both.

*Hint: Use set operations to perform these analyses. Also, see [Chapter 10](#) for a discussion of string tokenizing.*

## 6. Word Frequency

Write a program that reads the contents of a text file. The program should create a `map` in which the keys are the individual words found in the file and the values are the number of times each word appears. For example, if the word “the” appears 128 times, the map would contain an element with “the” as the key and 128 as the value. The program should either display the frequency of each word or create a second file containing a list of each word and its frequency.

*Hint: See [Chapter 10](#) for a discussion of string tokenizing.*

## 7. Word Index

Write a program that reads the contents of a text file. The program should create a `map` in which the key–value pairs are described as follows:

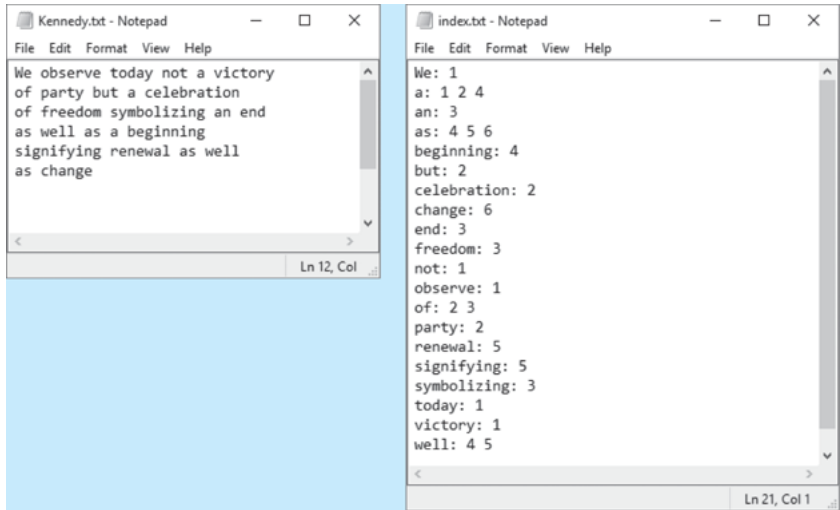
- Key—The keys are the individual words found in the file.
- Values—Each value is a `set` that contains the line numbers in the file where the word (the key) is found.

For example, suppose the word “robot” is found in lines 7, 18, 94, and 138. The `map` would contain an element in which the key was the string “robot”, and the value was a `set` containing the numbers 7, 18, 94, and 138.

Once the `map` is built, the program should create another text file, known as a word index, listing the contents of the `map`. The word index file should contain an alphabetical listing of the words that are stored as keys in the map, along with the line numbers where the words appears in the original file. [Figure 17-9](#) shows an example of an original text file (Kennedy.txt) and its index file (index.txt).

*Hint: See [Chapter 10](#) for a discussion of string tokenizing.*

Figure 17-9 Example original file and index file



## 8. Prime Number Generation

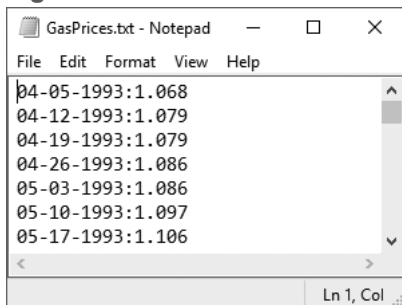
A positive integer greater than 1 is said to be *prime* if it has no divisors other than 1 and itself. A positive integer greater than 1 is *composite* if it is not prime. Write a program that asks the user to enter an integer greater than 1, then displays all of the prime numbers that are less than or equal to the number entered. The program should work as follows:

- Once the user has entered a number, the program should populate a `vector` with all of the integers from 2, up through the value entered.
- The program should then use the STL's `for_each` function to step through the `vector`. The `for_each` function should pass each element to a function object that displays the element if it is a prime number.

## 9. Gas Prices

In the student sample program files for this chapter, you will find a text file named `GasPrices.txt`. The file contains the weekly average prices for a gallon of gas in the U.S., beginning on April 5, 1993, and ending on August 26, 2013. [Figure 17-10](#) shows an example of the first few lines of the file's contents.

Figure 17-10 The `GasPrices.txt` file



Each line in the file contains the average price for a gallon of gas on a specific date. Each line is formatted in the following way:

```
MM-DD-YYYY:Price
```

`MM` is the two-digit month, `DD` is the two-digit day, and `YYYY` is the four-digit year. `Price` is the average price per gallon of gas on the specified date.

For this assignment, you are to write one or more programs that read the contents of the file and perform the following calculations:

**Average Price Per Year:** Calculate the average price of gas per year, for each year in the file.

(The file's data starts in April of 1993, and it ends in August 2013. Use the data that is present for the years 1993 and 2013.)

**Average Price Per Month:** Calculate the average price for each month in the file.

**Highest and Lowest Prices Per Year:** For each year in the file, determine the date and amount for the lowest price, and the highest price.

**List of Prices, Lowest to Highest:** Generate a text file that lists the dates and prices, sorted from the lowest price to the highest.

**List of Prices, Highest to lowest:** Generate a text file that lists the dates and prices, sorted from the highest price to the lowest.

You can write one program to perform all of these calculations, or you can write different programs, one for each calculation. Regardless of the approach that you take, you should read the contents of the `GasPrices.txt` file, and extract its data into one or more STL containers appropriate for your algorithm.

*Hint:* See [Chapter 10](#) for a discussion of string tokenizing.

---

# Chapter 18 Linked Lists

---

## Topics

18.1 Introduction to the Linked List ADT [📄](#)

18.2 Linked List Operations [📄](#)

18.3 A Linked List Template [📄](#)

18.4 Variations of the Linked List [📄](#)

18.5 The `STL list` and `forward_list` Containers [📄](#)

# 18.1 Introduction to the Linked List ADT

## **Concept:**

Dynamically allocated data structures may be linked together in memory to form a chain.

A linked list is a series of connected *nodes*, where each node is a data structure. A linked list can grow or shrink in size as the program runs. This is possible because the nodes in a linked list are dynamically allocated. If new data need to be added to a linked list, the program simply allocates another node and inserts it into the series. If a particular piece of data needs to be removed from the linked list, the program deletes the node containing that data.



# Advantages of Linked Lists over Arrays and `vector`s

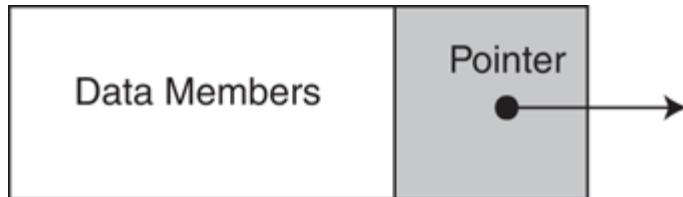
Although linked lists are more complex to code and manage than arrays, they have some distinct advantages. First, a linked list can easily grow or shrink in size. In fact, the programmer doesn't need to know how many nodes will be in the list. They are simply created in memory as they are needed.

One might argue that linked lists are not superior to `vector`s (found in the Standard Template Library), because `vector`s, too, can expand or shrink. The advantage that linked lists have over `vector`s, however, is the speed at which a node may be inserted into or deleted from the list. To insert a value into the middle of a `vector` requires all the elements below the insertion point to be moved one position toward the `vector`'s end, thus making room for the new value. Likewise, removing a value from a `vector` requires all the elements below the removal point to be moved one position toward the `vector`'s beginning. When a node is inserted into or deleted from a linked list, none of the other nodes have to be moved.

# The Composition of a Linked List

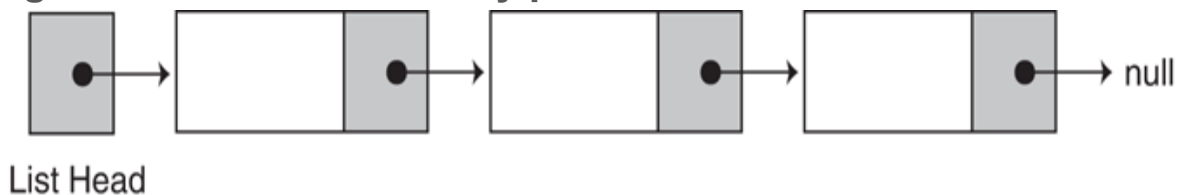
Each node in a linked list contains one or more members that represent data. (Perhaps the nodes hold inventory records, or customer names, addresses, and telephone numbers.) In addition to the data, each node contains a pointer, which can point to another node. The makeup of a node is illustrated in [Figure 18-1](#).

**Figure 18-1 A node**



A linked list is called “linked” because each node in the series has a pointer that points to the next node in the list. This creates a chain where the first node points to the second node, the second node points to the third node, and so on. This is illustrated in [Figure 18-2](#).

**Figure 18-2 Nodes linked by pointers**




The list depicted in [Figure 18-2](#) has three nodes, plus a pointer known as the *list head*. The head simply points to the first node in

the list. Each node, in turn, points to the next node in the list. The first node points to the second node, which points to the third node. Because the third node is the last one in the list, it points to the null address (address 0). This is usually how the end of a linked list is signified—by letting the last node point to null.



**Note:**

**Figure 18-2**  depicts the nodes in the linked list as being very close to each other, neatly arranged in a row. In reality, the nodes may be scattered around various parts of memory.

# Declarations

So how is a linked list created in C++? First you must declare a data structure that will be used for the nodes. For example, the following

`struct` could be used to create a list where each node holds a `double`:

```
struct ListNode
{
    double value;
    ListNode *next;
};
```

The first member of the `ListNode` structure is a `double` named `value`. It will be used to hold the node's data. The second member is a pointer named `next`. The pointer can hold the address of any object that is a `ListNode` structure. This allows each `ListNode` structure to point to the next `ListNode` structure in the list.

Because the `ListNode` structure contains a pointer to an object of the same type as that being declared, it is known as a *self-referential data structure*. This structure makes it possible to create nodes that point to other nodes of the same type.

The next step is to define a pointer to serve as the list head, as shown here:

```
ListNode *head;
```

Before you use the `head` pointer in any linked list operations, you must be sure it is initialized to `nullptr` because that marks the end of the list. Once you have declared a node data structure and have created a null `head` pointer, you have an empty linked list. The next step is to implement operations with the list.

## *Checkpoint*

18.1 Describe the two parts of a node.

18.2 What is a list head?

18.3 What signifies the end of a linked list?

18.4 What is a self-referential data structure?

## 18.2 Linked List Operations

### **Concept:**

The basic linked list operations are appending a node, traversing the list, inserting a node, deleting a node, and destroying the list.

In this section, we will develop an abstract data type that performs basic linked list operations using the `ListNode` structure and `head` pointer defined in the previous section. We will use the following class declaration, which is stored in `NumberList.h`.

## Contents of `NumberList.h`

```
1 // Specification file for the NumberList class
2 #ifndef NUMBERLIST_H
3 #define NUMBERLIST_H
4
5 class NumberList
6 {
7 private:
8     // Declare a structure for the list
9     struct ListNode
10    {
11        double value;        // The value in this node
12        struct ListNode *next; // To point to the next node
13    };
14
15    ListNode *head;        // List head pointer
16
17 public:
18     // Constructor
19     NumberList()
20     { head = nullptr; }
21
22     // Destructor
23     ~NumberList();
24
25     // Linked list operations
26     void appendNode(double);
27     void insertNode(double);
28     void deleteNode(double);
29     void displayList() const;
30 };
31 #endif
```

Notice the constructor initializes the `head` pointer to `nullptr`. This establishes an empty linked list. The class has member functions for appending, inserting, and deleting nodes, as well as a `displayList`

function that displays all the values stored in the list. The destructor destroys the list by deleting all its nodes. These functions are defined in `NumberList.cpp`. We will examine the member functions individually.



# Appending a Node to the List



## Appending a Node to a Linked List

To append a node to a linked list means to add the node to the end of the list. The `appendNode` member function accepts a `double` argument, `num`. The function will allocate a new `ListNode` structure, store the value in `num` in the node's `value` member, and append the node to the end of the list. Here is a pseudocode representation of the general algorithm:

```
Create a new node.
```

```
Store data in the new node.
```

```
If there are no nodes in the list
```

```
Make the new node the first node.
```

```
Else
```

```
Traverse the list to find the last node.
```

```
Add the new node to the end of the list.
```

```
End If.
```

Here is the actual C++ code for the function:

```
11 void NumberList::appendNode(double num)
12 {
13     ListNode *newNode; // To point to a new node
14     ListNode *nodePtr; // To move through the list
15
16     // Allocate a new node and store num there.
17     newNode = new ListNode;
18     newNode->value = num;
19     newNode->next = nullptr;
20
21     // If there are no nodes in the list
22     // make newNode the first node.
23     if (!head)
24         head = newNode;
25     else // Otherwise, insert newNode at end.
26     {
27         // Initialize nodePtr to head of list.
28         nodePtr = head;
29
30         // Find the last node in the list.
31         while (nodePtr->next)
32             nodePtr = nodePtr->next;
33
34         // Insert newNode as the last node.
35         nodePtr->next = newNode;
36     }
37 }
```

Let's examine the statements in detail. In lines 13 and 14, the function defines the following local variables:

```
ListNode *newNode; // To point to a new node
ListNode *nodePtr; // To move through the list
```

The `newNode` pointer will be used to allocate and point to the new node. The `nodePtr` pointer will be used to travel down the linked list, in search of the last node.

The following statements, in lines 17 through 19, create a new node and store `num` in its `value` member:

```
newNode = new ListNode;  
newNode->value = num;  
newNode->next = nullptr;
```

The statement in line 19 is important. Because this node will become the last node in the list, its `next` pointer must be a null pointer.

In line 23, we test the `head` pointer to determine whether there are any nodes already in the list. If `head` points to `nullptr`, we make the new node the first in the list. Making `head` point to the new node does this. Here is the code:

```
if (!head)  
    head = newNode;
```

If `head` does not point to `nullptr`, however, there are nodes in the list. The `else` part of the `if` statement must contain code to find the end of the list and insert the new node. The code, in lines 25 through 36, is shown here:

```
else  
{  
    // Initialize nodePtr to head of list.  
    nodePtr = head;  
    // Find the last node in the list.  
    while (nodePtr->next)  
        nodePtr = nodePtr->next;  
    // Insert newNode as the last node.  
    nodePtr->next = newNode;  
}
```

The code uses `nodePtr` to travel down the list. It does this by first assigning `nodePtr` to `head` in line 28.

```
nodePtr = head;
```

The `while` loop in lines 31 and 32 is then used to *traverse* (or travel through) the list searching for the last node. The last node will be the one whose `next` member points to `nullptr`.

```
while (nodePtr->next)
    nodePtr = nodePtr->next;
```

When `nodePtr` points to the last node in the list, we make its `next` member point to `newNode` in line 35 with the following statement:

```
nodePtr->next = newNode;
```

This inserts `newNode` at the end of the list. (Remember, `newNode->next` already points to `nullptr`.)

**Program 18-1** [□](#) demonstrates the function.

## Program 18-1

```
1 // This program demonstrates a simple append
2 // operation on a linked list.
3 #include <iostream>
4 #include "NumberList.h"
5 using namespace std;
6
7 int main()
8 {
9     // Define a NumberList object.
10    NumberList list;
11
12    // Append some values to the list.
13    list.appendNode(2.5);
14    list.appendNode(7.9);
15    list.appendNode(12.6);
16    return 0;
17 }
    (This program displays no output.)
```

Let's step through the program, observing how the `appendNode` function builds a linked list to store the three argument values used.

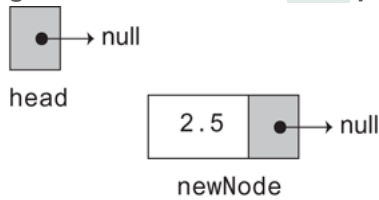
The `head` pointer is declared as a private member variable of the `NumberList` class. `head` is initialized to `nullptr` by the `NumberList` constructor, which indicates that the list is empty.

The first call to `appendNode` in line 13 passes 2.5 as the argument. In the following statements, a new node is allocated in memory, 2.5 is copied into its `value` member, and `nullptr` is assigned to the node's `next` pointer:

```
newNode = new ListNode;
newNode->value = num;
newNode->next = nullptr;
```

Figure 18-3 illustrates the state of the `head` pointer and the new node.

Figure 18-3 State of the `head` pointer and the new node

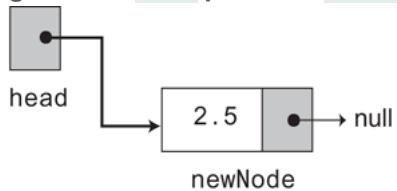


The next statement to execute is the following `if` statement:

```
if (!head)
    head = newNode;
```

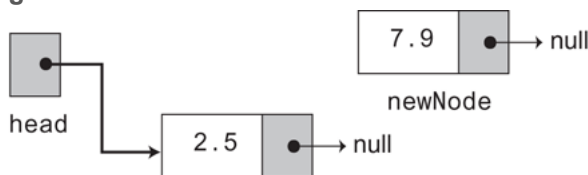
Because `head` is a null pointer, the condition `!head` is true. The statement `head = newNode;` is executed, making `newNode` the first node in the list. This is illustrated in Figure 18-4.

Figure 18-4 `head` points to `newNode`



There are no more statements to execute, so control returns to function `main`. In the second call to `appendNode`, in line 14, `7.9` is passed as the argument. Once again, the first three statements in the function create a new node, store the argument in the node's `value` member, and assign its `next` pointer to `nullptr`. Figure 18-5 illustrates the current state of the list and the new node.

Figure 18-5 A new node is created



Because `head` no longer points to `nullptr`, the `else` part of the `if` statement executes:

```

else // Otherwise, insert newNode at end.
{
    // Initialize nodePtr to head of list.
    nodePtr = head;

```

```

    // Find the last node in the list.
    while (nodePtr->next)
        nodePtr = nodePtr->next;

```

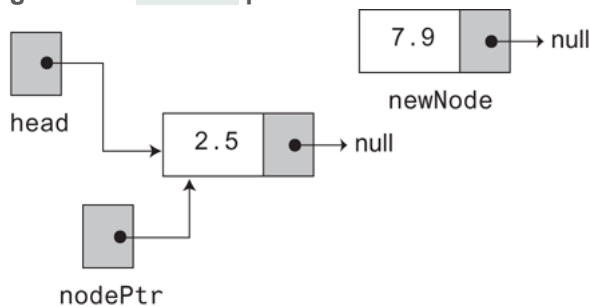
```

    // Insert newNode as the last node.
    nodePtr->next = newNode;
}

```

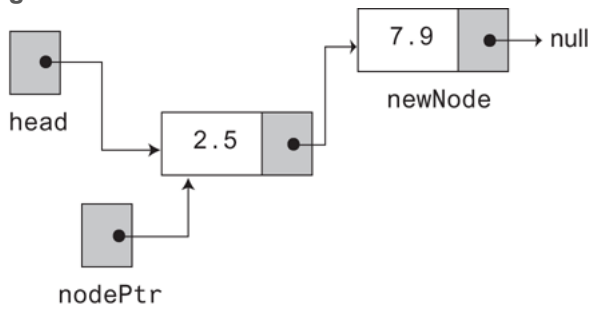
The first statement in the `else` block assigns the value in `head` to `nodePtr`. This causes `nodePtr` to point to the same node that `head` points to. This is illustrated in [Figure 18-6](#).

**Figure 18-6** `nodePtr` points to the first node



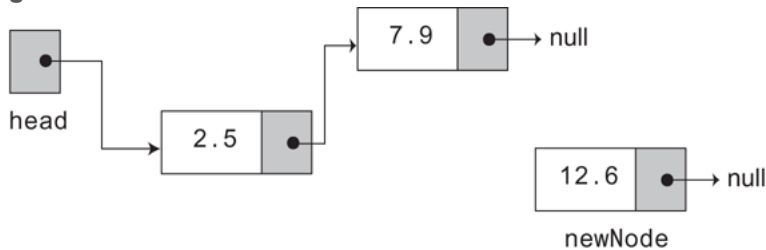
Look at the `next` member of the node that `nodePtr` points to. It is a null pointer, which means that `nodePtr->next` is also a null pointer. `nodePtr` is already at the end of the list, so the `while` loop immediately terminates. The last statement, `nodePtr->next = newNode;` causes `nodePtr->next` to point to the new node. This inserts `newNode` at the end of the list as shown in [Figure 18-7](#).

Figure 18-7 The new node is added to the list



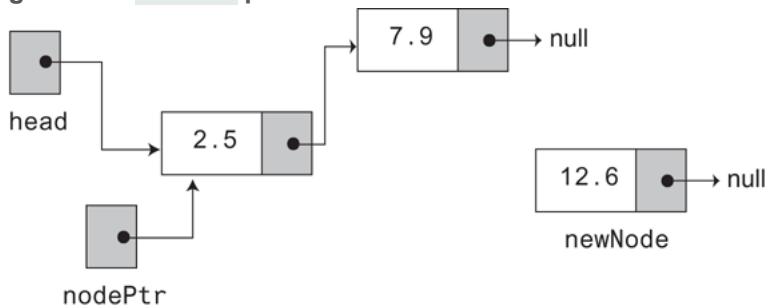
The third time `appendNode` is called, in line 15, 12.6 is passed as the argument. Once again, the first three statements create a node with the argument stored in the `value` member. This is shown in [Figure 18-8](#).

Figure 18-8 A new node is created



Next, the `else` part of the `if` statement executes. As before, `nodePtr` is made to point to the same node as `head`, as shown in [Figure 18-9](#).

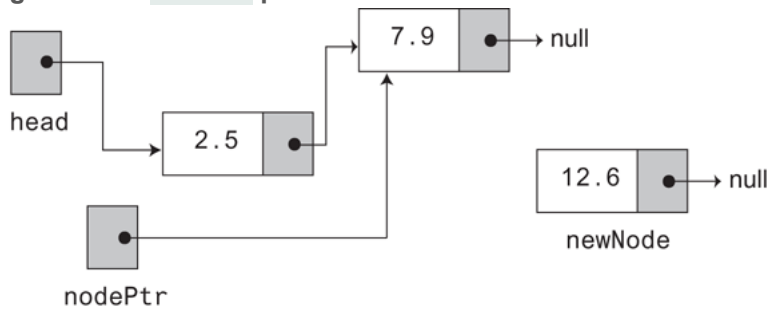
Figure 18-9 `nodePtr` points to the first node



Because `nodePtr->next` is not a null pointer, the `while` loop will execute. After its first iteration, `nodePtr` will point to the second node in the list. This is shown in [Figure 18-10](#).

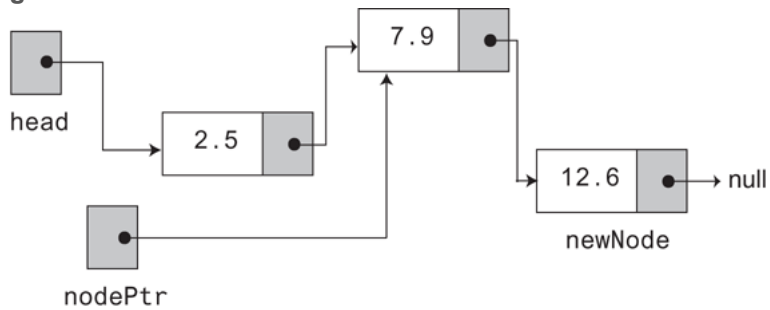


Figure 18-10 `nodePtr` points to the second node



The `while` loop's conditional test will fail after the first iteration because `nodePtr->next` is now a null pointer. The last statement, `nodePtr->next = newNode;` causes `nodePtr->next` to point to the new node. This inserts `newNode` at the end of the list as shown in [Figure 18-11](#).

Figure 18-11 The new node is added to the list



[Figure 18-11](#) depicts the final state of the linked list.

# Traversing a Linked List

The `appendNode` function demonstrated in the previous section contains a `while` loop that traverses, or travels through the linked list. In this section, we will demonstrate the `displayList` member function that traverses the list, displaying the `value` member of each node. The following pseudocode represents the algorithm:

```
Assign List head to node pointer.
```

```
While node pointer is not null
```

```
    Display the value member of the node pointed to by node pointer.
```

```
    Assign node pointer to its own next member.
```

```
End While.
```

The function is shown here:

```
45 void NumberList::displayList() const
46 {
47     ListNode *nodePtr; // To move through the list
48
49     // Position nodePtr at the head of the list.
50     nodePtr = head;
51
52     // While nodePtr points to a node, traverse
53     // the list.
54     while (nodePtr)
55     {
56         // Display the value in this node.
57         cout << nodePtr->value << endl;
58
59         // Move to the next node.
60         nodePtr = nodePtr->next;
61     }
62 }
```

**Program 18-2** , a modification of **Program 18-1** , demonstrates the function.

## Program 18-2

```
1 // This program demonstrates the displayList member function.
2 #include <iostream>
3 #include "NumberList.h"
4 using namespace std;
5
6 int main()
7 {
8     // Define a NumberList object.
9     NumberList list;
10
11     // Append some values to the list.
12     list.appendNode(2.5);
13     list.appendNode(7.9);
14     list.appendNode(12.6);
15
16     // Display the values in the list.
17     list.displayList();
18     return 0;
19 }
```

## Program Output

```
2.5
7.9
12.6
```

Usually, when an operation is to be performed on some or all the nodes in a linked list, a traversal algorithm is used. You will see variations of this algorithm throughout this chapter.

# Inserting a Node

Appending a node is a straightforward procedure. Inserting a node in the middle of a list, however, is more involved. For example, suppose the values in a list are sorted, and you wish all new values to be inserted in their proper position. This will preserve the order of the list. Using the `ListNode` structure again, the following pseudocode shows an algorithm for finding a new node's proper position in the list and inserting it there. The algorithm assumes the nodes in the list are already in order.



## Inserting a Node in a Linked List

```
Create a new node.
```

```
Store data in the new node.
```

```
If there are no nodes in the list
```

```
Make the new node the first node.
```

```
Else
```

```
Find the first node whose value is greater than or equal to the new
```

```
value, or the end of the list (whichever is first).
```

```
Insert the new node before the found node, or at the end of the list
```

```
if no such node was found.
```

```
End If.
```

Notice the new algorithm finds the first node whose value is greater than or equal to the new value. The new node is then inserted before the found node. This will require the use of two node pointers during the traversal: one to point to the node being inspected, and another to point to the previous node. The code for the traversal algorithm is as follows. (As before, `num` holds the value being inserted into the list.)

```
// Position nodePtr at the head of list.  
nodePtr = head;
```

```
// Initialize previousNode to nullptr.  
previousNode = nullptr;
```

```
// Skip all nodes whose value is less than num.  
while (nodePtr != nullptr && nodePtr->value < num)  
{  
    previousNode = nodePtr;  
    nodePtr = nodePtr->next;  
}
```

This code segment uses the `ListNode` pointers `nodePtr` and `previousNode`. `previousNode` always points to the node before the one pointed to by `nodePtr`. The entire `insertNode` function is shown here:

```

69 void NumberList::insertNode(double num)
70 {
71     ListNode *newNode;           // A new node
72     ListNode *nodePtr;           // To traverse the list
73     ListNode *previousNode = nullptr; // The previous node
74
75     // Allocate a new node and store num there.
76     newNode = new ListNode;
77     newNode->value = num;
78
79     // If there are no nodes in the list
80     // make newNode the first node
81     if (!head)
82     {
83         head = newNode;
84         newNode->next = nullptr;
85     }
86     else // Otherwise, insert newNode
87     {
88         // Position nodePtr at the head of list.
89         nodePtr = head;
90
91         // Initialize previousNode to nullptr.
92         previousNode = nullptr;
93
94         // Skip all nodes whose value is less than num.
95         while (nodePtr != nullptr && nodePtr->value < num)
96         {
97             previousNode = nodePtr;
98             nodePtr = nodePtr->next;
99         }
100
101         // If the new node is to be the 1st in the list,
102         // insert it before all other nodes.
103         if (previousNode == nullptr)
104         {
105             head = newNode;
106             newNode->next = nodePtr;
107         }
108         else // Otherwise insert after the previous node.
109         {

```

```
110     previousNode->next = newNode;  
111     newNode->next = nodePtr;  
112 }  
113 }  
114 }
```

**Program 18-3**  is a modification of **Program 18-2** . It uses the `insertNode` member function to insert a value in its ordered position in the list.



## Program 18-3

```
1 // This program demonstrates the insertNode member function.
2 #include <iostream>
3 #include "NumberList.h"
4 using namespace std;
5
6 int main()
7 {
8     // Define a NumberList object.
9     NumberList list;
10
11     // Build the list with some values.
12     list.appendNode(2.5);
13     list.appendNode(7.9);
14     list.appendNode(12.6);
15
16     // Insert a node in the middle of the list.
17     list.insertNode(10.5);
18
19     // Display the list
20     list.displayList();
21     return 0;
22 }
```

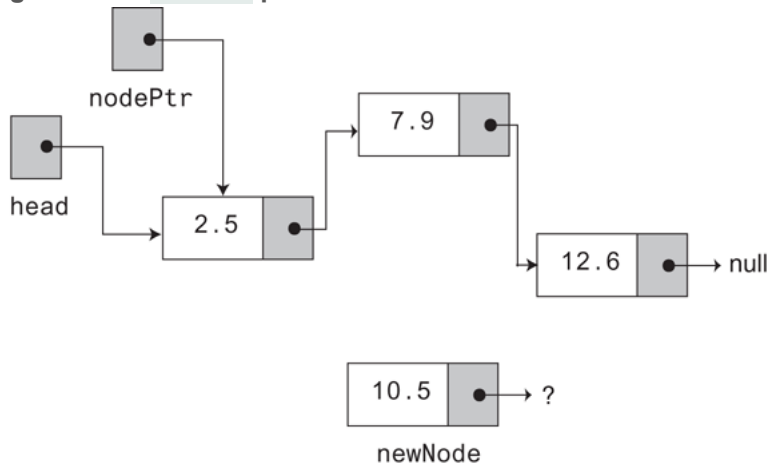
## Program Output

```
2.5
7.9
10.5
12.6
```

Like [Program 18-2](#), [Program 18-3](#) calls the `appendNode` function three times to build the list with the values 2.5, 7.9, and 12.6. The `insertNode` function is then called, with the argument 10.5.

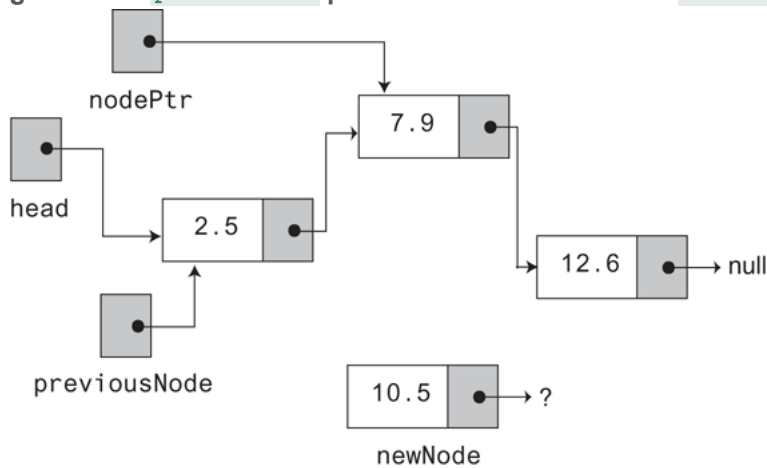
In `insertNode`, a new node is created, and the function argument is copied to its `value` member. Because the list already has nodes stored in it, the `else` part of the `if` statement will execute. It begins by assigning `nodePtr` to `head`. [Figure 18-12](#) illustrates the state of the list at this point.

**Figure 18-12** `nodePtr` points to the first node



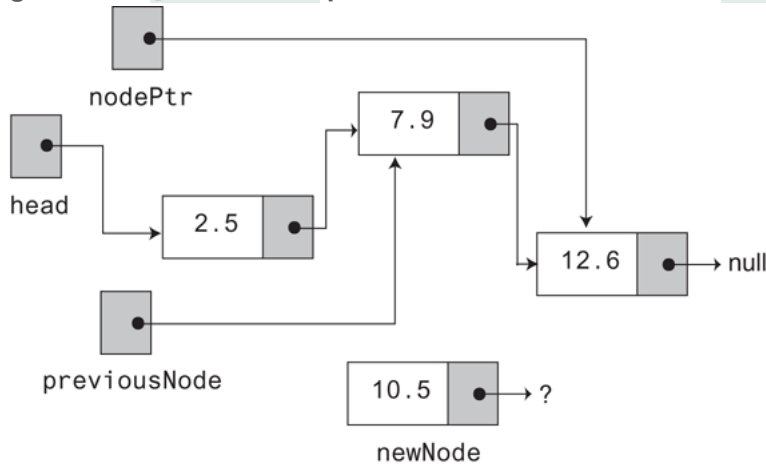
Because `nodePtr` is not a null pointer and `nodePtr->value` is less than `num`, the `while` loop will iterate. During the iteration, `previousNode` will be made to point to the node that `nodePtr` is pointing to. `nodePtr` will then be advanced to point to the next node. This is shown in [Figure 18-13](#).

**Figure 18-13** `previousNode` points to the first node and `nodePtr` points to the second node



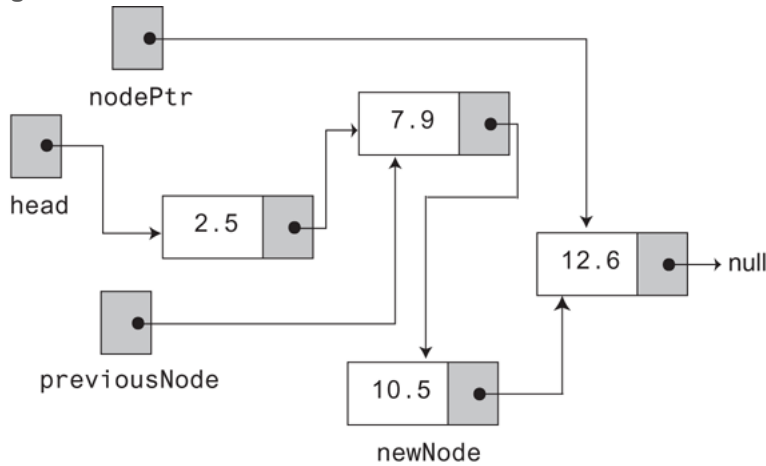
Once again, the loop performs its test. Because `nodePtr` is not a null pointer and `nodePtr->value` is less than `num`, the loop will iterate a second time. During the second iteration, both `previousNode` and `nodePtr` are advanced by one node in the list. This is shown in [Figure 18-14](#).

Figure 18-14 `previousNode` points to the second node and `nodePtr` points to the third node



This time, the loop's test will fail because `nodePtr->value` is not less than `num`. The statements after the loop will execute, which cause `previousNode->next` to point to `newNode`, and `newNode->next` to point to `nodePtr`. This is illustrated in [Figure 18-15](#).

Figure 18-15 The new node inserted



This leaves the list in its final state. If you follow the links, from the `head` pointer to the null pointer, you will see the nodes are stored in the order of their `value` members.

## Checkpoint

- 18.5 What is the difference between appending a node to a list and inserting a node into a list?
- 18.6 Which is easier to code, appending or inserting?
- 18.7 Why does the `insertNode` function shown in this section use a `previousNode` pointer?

# Deleting a Node

Deleting a node from a linked list requires two steps:

1. Remove the node from the list without breaking the links created by the `next` pointers.
2. Delete the node from memory.




## Deleting a Node from a Linked List

The `deleteNode` member function searches for a node containing a particular value and deletes it from the list. It uses an algorithm similar to the `insertNode` function. Two node pointers, `nodePtr` and `previousNode`, are used to traverse the list. `previousNode` always points to the node whose position is just before the one pointed to by `nodePtr`. When `nodePtr` points to the node that is to be deleted, `previousNode->next` is made to point to `nodePtr->next`. This removes the node pointed to by `nodePtr` from the list. The final step performed by this function is to free the memory used by the node with the `delete` operator. The entire function is shown below:

```

122 void NumberList::deleteNode(double num)
123 {
124     ListNode *nodePtr;    // To traverse the list
125     ListNode *previousNode; // To point to the previous node
126
127     // If the list is empty, do nothing.
128     if (!head)
129         return;
130
131     // Determine if the first node is the one.
132     if (head->value == num)
133     {
134         nodePtr = head->next;
135         delete head;
136         head = nodePtr;
137     }
138     else
139     {
140         // Initialize nodePtr to head of list
141         nodePtr = head;
142
143         // Skip all nodes whose value member is
144         // not equal to num.
145         while (nodePtr != nullptr && nodePtr->value != num)
146         {
147             previousNode = nodePtr;
148             nodePtr = nodePtr->next;
149         }
150
151         // If nodePtr is not at the end of the list,
152         // link the previous node to the node after
153         // nodePtr, then delete nodePtr.
154         if (nodePtr)
155         {
156             previousNode->next = nodePtr->next;
157             delete nodePtr;
158         }
159     }
160 }

```

**Program 18-4**  demonstrates the function by first building a list of three nodes, then deleting them one by one.

## Program 18-4

```
1 // This program demonstrates the deleteNode member function.
2 #include <iostream>
3 #include "NumberList.h"
4 using namespace std;
5
6 int main()
7 {
8     // Define a NumberList object.
9     NumberList list;
10
11     // Build the list with some values.
12     list.appendNode(2.5);
13     list.appendNode(7.9);
14     list.appendNode(12.6);
15
16     // Display the list.
17     cout << "Here are the initial values:\n";
18     list.displayList();
19     cout << endl;
20
21     // Delete the middle node.
22     cout << "Now deleting the node in the middle.\n";
23     list.deleteNode(7.9);
24
25     // Display the list.
26     cout << "Here are the nodes left.\n";
27     list.displayList();
28     cout << endl;
29
30     // Delete the last node.
31     cout << "Now deleting the last node.\n";
32     list.deleteNode(12.6);
33
34     // Display the list.
35     cout << "Here are the nodes left.\n";
36     list.displayList();
37     cout << endl;
```

```

38
39 // Delete the only node left in the list.
40 cout << "Now deleting the only remaining node.\n";
41 list.deleteNode(2.5);
42
43 // Display the list.
44 cout << "Here are the nodes left.\n";
45 list.displayList();
46 return 0;
47 }

```

### Program Output

```

Here are the initial values:
2.5
7.9
12.6

Now deleting the node in the middle.
Here are the nodes left.
2.5
12.6

Now deleting the last node.
Here are the nodes left.
2.5

Now deleting the only remaining node.
Here are the nodes left.

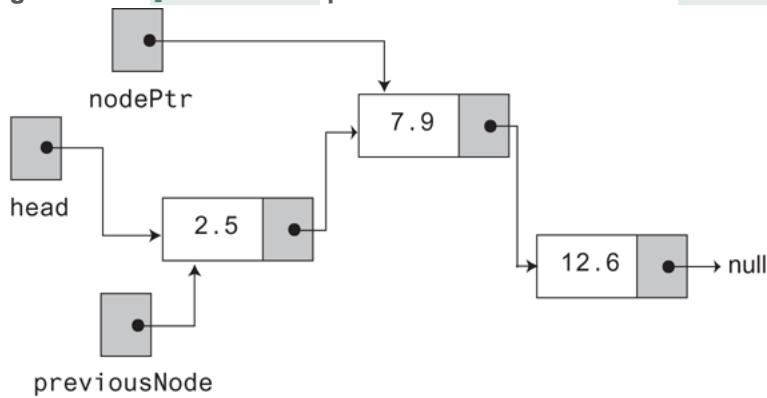
```

To illustrate how `deleteNode` works, we will step through the first call, which deletes the node containing 7.9 as its value. This node is in the middle of the list.

In the `deleteNode` function, look at the `else` part of the second `if` statement. This is lines 138 through 159. This is where the function will perform its action since the list is not empty, and the first node does not contain the value 7.9. Just like `insertNode`, this function uses `nodePtr` and `previousNode` to traverse the list. The `while` loop in lines 145 through 149 terminates when the value 7.9 is located. At this point, the list and the other pointers will be in the state depicted in [Figure 18-16](#).



Figure 18-16 `previousNode` points to the first node and `nodePtr` points to the second node

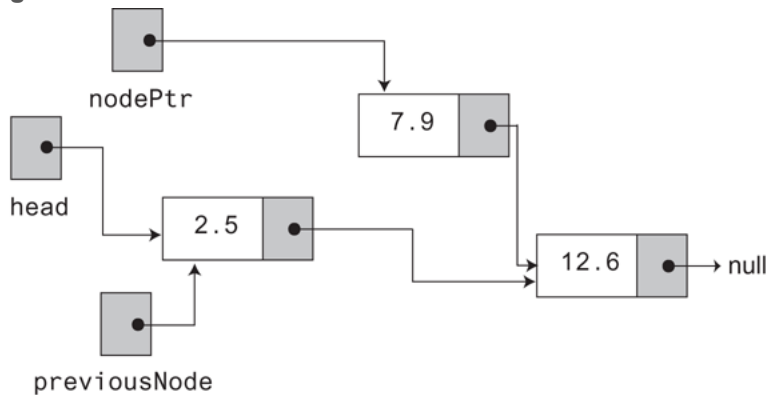


Next, the following statement in line 156 executes:

```
previousNode->next = nodePtr->next;
```

This statement causes the links in the list to bypass the node to which `nodePtr` points. Although the node still exists in memory, this removes it from the list, as illustrated in [Figure 18-17](#).

Figure 18-17 Node removed from the list



The statement in line 157 uses the `delete` operator to complete the total deletion of the node.

# Destroying the List

It's important for the class's destructor to release all the memory used by the list. It does so by stepping through the list, deleting one node at a time. The code is shown here:

```
167 NumberList::~NumberList()
168 {
169     ListNode *nodePtr; // To traverse the list
170     ListNode *nextNode; // To point to the next node
171
172     // Position nodePtr at the head of the list.
173     nodePtr = head;
174
175     // While nodePtr is not at the end of the list...
176     while (nodePtr != nullptr)
177     {
178         // Save a pointer to the next node.
179         nextNode = nodePtr->next;
180
181         // Delete the current node.
182         delete nodePtr;
183
184         // Position nodePtr at the next node.
185         nodePtr = nextNode;
186     }
187 }
```

Notice the use of `nextNode` instead of `previousNode`. The `nextNode` pointer is used to hold the position of the next node in the list so it will be available after the node pointed to by `nodePtr` is deleted.

## Checkpoint

18.8 What are the two steps involved in deleting a node from a linked list?

18.9 When deleting a node, why can't you just use the `delete` operator to remove it from memory? Why must you take the steps you listed in response to Question 18.8?

18.10 In a program that uses several linked lists, what might eventually happen if the class destructor does not destroy its linked list?

## 18.3 A Linked List Template

### Concept:

A template can be easily created to store linked lists of any type.

The limitation of the `NumberList` class is that it can only hold `double` values. The class can easily be converted to a template that will accept any data type, as shown in the following code. (This file can be found in the Student Source Code Folder **Chapter 18** [\LinkedList Template Version 1.](#))

## Contents of `LinkedList.h` (Version 1)

```
1 // A class template for holding a linked
list.
2 #ifndef LINKEDLIST_H
3 #define LINKEDLIST_H
4 #include <iostream> // For cout
5 using namespace std;
6
7 template <class T>
8 class LinkedList
9 {
10 private:
11     // Declare a structure for the list.
12     struct ListNode
13     {
14         T value; // The value
in this node
15         struct ListNode *next; // To point
to the next node
16     };
17
18     ListNode *head; // List head pointer
19
20 public:
```

```

21     // Constructor
22     NumberList()
23         { head = nullptr; }
24
25     // Destructor
26     ~NumberList();
27
28     // Linked list operations
29     void appendNode(T);
30     void insertNode(T);
31     void deleteNode(T);
32     void displayList() const;
33 };
34
35
36
//*****
**
37 // appendNode appends a node containing the
value *
38 // passed into newValue, to the end of the
list. *
39
//*****
**
40
41 template <class T>

```

```
42 void LinkedList<T>::appendNode(T newValue)
43 {
44     ListNode *newNode; // To point to a new
node
45     ListNode *nodePtr; // To move through
the list
46
47     // Allocate a new node and store num
there.
48     newNode = new ListNode;
49     newNode->value = num;
50     newNode->next = nullptr;
51
52     // If there are no nodes in the list
53     // make newNode the first node.
54     if (!head)
55         head = newNode;
56     else // Otherwise, insert newNode at
end.
57     {
58         // Initialize nodePtr to head of
list.
59         nodePtr = head;
60
61         // Find the last node in the list.
62         while (nodePtr->next)
63             nodePtr = nodePtr->next;
```

```

64
65         // Insert newNode as the last node.
66         nodePtr->next = newNode;
67     }
68 }
69
70
//*****
**
71 // displayList shows the value
*
72 // stored in each node of the linked list
*
73 // pointed to by head.
*
74
//*****
**
75
76 template <class T>
77 void LinkedList<T>::displayList()
78 {
79     ListNode *nodePtr; // To move through the
list
80
81     // Position nodePtr at the head of the
list.

```

```

82     nodePtr = head;
83
84     // While nodePtr points to a node,
traverse
85     // the list.
86     while (nodePtr)
87     {
88         // Display the value in this node.
89         cout << nodePtr->value << endl;
90
91         // Move to the next node.
92         nodePtr = nodePtr->next;
93     }
94 }
95
96
//*****
**
97 // The insertNode function inserts a node
with *
98 // newValue copied to its value member.
*
99
//*****
**
100
101 template <class T>

```



```
102 void LinkedList<T>::insertNode(T newValue)
103 {
104     ListNode *newNode;           // A
new node
105     ListNode *nodePtr;         // To
traverse the list
106     ListNode *previousNode = nullptr; // The
previous node
107
108     // Allocate a new node and store num
there.
109     newNode = new ListNode;
110     newNode->value = num;
111
112     // If there are no nodes in the list
113     // make newNode the first node.
114     if (!head)
115     {
116         head = newNode;
117         newNode->next = nullptr;
118     }
119     else // Otherwise, insert newNode.
120     {
121         // Position nodePtr at the head of
list.
122         nodePtr = head;
123
```

```
124         // Initialize previousNode to
nullptr.
125         previousNode = nullptr;
126
127         // Skip all nodes whose value is less
than num.
128         while (nodePtr != nullptr && nodePtr->
value < num)
129         {
130             previousNode = nodePtr;
131             nodePtr = nodePtr->next;
132         }
133
134         // If the new node is to be the 1st
in the list,
135         // insert it before all other nodes.
136         if (previousNode == nullptr)
137         {
138             head = newNode;
139             newNode->next = nodePtr;
140         }
141         else // Otherwise insert after the
previous node.
142         {
143             previousNode->next = newNode;
144             newNode->next = nodePtr;
145         }
```

```

146     }
147 }
148
149
//*****
*****
150 // The deleteNode function searches for a
node *
151 // with searchValue as its value. The node,
if found, *
152 // is deleted from the list and from memory.
*
153
//*****
*****
154
155 template <class T>
156 void LinkedList<T>::deleteNode(T searchValue)
157 {
158     ListNode *nodePtr; // To traverse
the list
159     ListNode *previousNode; // To point to
the previous node
160
161     // If the list is empty, do nothing.
162     if (!head)
163         return;

```

```
164
165     // Determine if the first node is the
one.
166     if (head->value == num)
167     {
168         nodePtr = head->next;
169         delete head;
170         head = nodePtr;
171     }
172     else
173     {
174         // Initialize nodePtr to head of
list.
175         nodePtr = head;
176
177         // Skip all nodes whose value member
is
178         // not equal to num.
179         while (nodePtr != nullptr && nodePtr-
>value != num)
180         {
181             previousNode = nodePtr;
182             nodePtr = nodePtr->next;
183         }
184
185         // If nodePtr is not at the end of
the list,
```

```

186         // link the previous node to the node
after
187         // nodePtr, then delete nodePtr.
188         if (nodePtr)
189         {
190             previousNode->next = nodePtr-
>next;
191             delete nodePtr;
192         }
193     }
194 }
195
196
//*****
**
197 // Destructor
*
198 // This function deletes every node in the
list. *
199
//*****
**
200
201 template <class T>
202 LinkedList<T>::~~LinkedList()
203 {
204     ListNode *nodePtr; // To traverse the

```

```
list
205     ListNode *nextNode; // To point to the
next node
206
207     // Position nodePtr at the head of the
list.
208     nodePtr = head;
209
210     // While nodePtr is not at the end of the
list...
211     while (nodePtr != nullptr)
212     {
213         // Save a pointer to the next node.
214         nextNode = nodePtr->next;
215
216         // Delete the current node.
217         delete nodePtr;
218
219         // Position nodePtr at the next node.
220         nodePtr = nextNode;
221     }
222 }
223 #endif
```

Note the template uses the `==`, `!=`, and `<` relational operators to compare node values, and it uses the `<<` operator with `cout` to display node values. Any type passed to the template must support these operators.

Now let's see how the template can be used to create a list of objects. Recall the `FeetInches` class introduced in [Chapter 14](#). That class overloaded numerous operators, including `==`, `<`, and `<<`. In the `Chapter 18\LinkedList Template Version 1` folder, we have included a modified version of the `FeetInches` class that also overloads the `!=` operator. [Program 18-5](#) is stored in that same folder. This program uses the `LinkedList` template to create a linked list of `FeetInches` objects.

## Program 18-5

```
1 // This program demonstrates the linked list
template.
2 #include <iostream>
3 #include "LinkedList.h"
4 #include "FeetInches.h"
5 using namespace std;
6
7 int main()
8 {
9     // Define a LinkedList object.
10    LinkedList<FeetInches> list;
11
12    // Define some FeetInches objects.
13    FeetInches distance1(5, 4); // 5 feet 4
inches
14    FeetInches distance2(6, 8); // 6 feet 8
inches
15    FeetInches distance3(8, 9); // 8 feet 9
inches
16
17    // Store the FeetInches objects in the
list.
18    list.appendNode(distance1); // 5 feet 4
```



```
inches
19     list.appendNode(distance2); // 6 feet 8
inches
20     list.appendNode(distance3); // 8 feet 9
inches
21
22     // Display the values in the list.
23     cout << "Here are the initial values:\n";
24     list.displayList();
25     cout << endl;
26
27     // Insert another FeetInches object.
28     cout << "Now inserting the value 7 feet 2
inches.\n";
29     FeetInches distance4(7, 2);
30     list.insertNode(distance4);
31
32     // Display the values in the list.
33     cout << "Here are the nodes now.\n";
34     list.displayList();
35     cout << endl;
36
37     // Delete the last node.
38     cout << "Now deleting the last node.\n";
39     FeetInches distance5(8, 9);
40     list.deleteNode(distance5);
41
```

```
42     // Display the values in the list.
43     cout << "Here are the nodes left.\n";
44     list.displayList();
45     return 0;
46 }
```

## Program Output

Here are the initial values:

5 feet, 4 inches

6 feet, 8 inches

8 feet, 9 inches

Now inserting the value 7 feet 2 inches.

Here are the nodes now.

5 feet, 4 inches

6 feet, 8 inches

7 feet, 2 inches

8 feet, 9 inches

Now deleting the last node.

Here are the nodes left.

5 feet, 4 inches

6 feet, 8 inches

7 feet, 2 inches

# Using a Class Node Type

In the `LinkedList` class template, the following structure was used to create a data type for the linked list node:

```
struct ListNode
{
    T value;
    struct ListNode *next;
};
```

Another approach is to use a separate class template to create a data type for the node. Then, the class constructor can be used to store an item in the `value` member and set the `next` pointer to `nullptr`. Here is an example:

```
template <class T>
class ListNode
{
public:
    T value; // Node value
    ListNode<T> *next; // Pointer to the next node
    // Constructor
    ListNode (T nodeValue)
    { value = nodeValue;
      next = nullptr; }
};
```

The `LinkedList` class template can then be written as the following:

```

template <class T>
class LinkedList
{
private:
    ListNode<T> *head; // List head pointer
public:
    // Constructor
    LinkedList()
        { head = nullptr; }
    // Destructor
    ~LinkedList();
    // Linked list operations
    void appendNode(T);
    void insertNode(T);
    void deleteNode(T);
    void displayList() const;
};


```

Because the `ListNode` class constructor assigns a value to the `value` member and sets the `next` pointer to `nullptr`, some of the code in the `LinkedList` class can be simplified. For example, the following code appears in the previous version of the `LinkedList` class template's `appendNode` function:

```
newNode = new ListNode;  
newNode->value = newValue;  
newNode->next = nullptr;
```

By using the `ListNode` class template with its constructor, these three lines of code can be reduced to one:

```
newNode = new ListNode<T>(newValue);
```

(This file can be found in the Student Source Code Folder **Chapter 18**  \LinkedList Template Version 2.)

## Contents of `LinkedList.h` (Version 2)

```
1 // A class template for holding a linked
list.
2 // The node type is also a class template.
3 #ifndef LINKEDLIST_H
4 #define LINKEDLIST_H
5
6
//*****
7 // The ListNode class creates a type used to
*
8 // store a node of the linked list.      *
9
//*****
10
11 template <class T>
12 class ListNode
13 {
14 public:
15     T value; // Node value
16     ListNode<T> *next; // Pointer to the next
node
17
18     // Constructor
```



```
19     ListNode (T nodeValue)
20         { value = nodeValue;
21           next = nullptr; }
22 };
23
24
25 //*****
26 // LinkedList class *
27
28 //*****
29 template <class T>
30 class LinkedList
31 {
32     private:
33         ListNode<T> *head; // List head pointer
34
35     public:
36         // Constructor
37         LinkedList()
38             { head = nullptr; }
39
40         // Destructor
41         ~LinkedList();
42
43         // Linked list operations
44         void appendNode(T);
```

```
44     void insertNode(T);
45     void deleteNode(T);
46     void displayList() const;
47 };
48
49
50
//*****
**
51 // appendNode appends a node containing the
value *
52 // passed into newValue, to the end of the
list. *
53
//*****
**
54
55 template <class T>
56 void LinkedList<T>::appendNode(T newValue)
57 {
58     ListNode<T> *newNode; // To point to a
new node
59     ListNode<T> *nodePtr; // To move through
the list
60
61     // Allocate a new node and store newValue
there.
```

```

62     newNode = new ListNode<T>(newValue);
63
64     // If there are no nodes in the list
65     // make newNode the first node.
66     if (!head)
67         head = newNode;
68     else // Otherwise, insert newNode at
end.
69     {
70         // Initialize nodePtr to head of
list.
71         nodePtr = head;
72
73         // Find the last node in the list.
74         while (nodePtr->next)
75             nodePtr = nodePtr->next;
76
77         // Insert newNode as the last node.
78         nodePtr->next = newNode;
79     }
80 }
81
82
//*****
***
83 // displayList shows the value stored in each
node *

```

```

84 // of the linked list pointed to by head.
*
85
//*****
***
86
87 template <class T>
88 void LinkedList<T>::displayList() const
89 {
90     ListNode<T> *nodePtr; // To move through
the list
91
92     // Position nodePtr at the head of the
list.
93     nodePtr = head;
94
95     // While nodePtr points to a node,
traverse
96     // the list.
97     while (nodePtr)
98     {
99         // Display the value in this node.
100        cout << nodePtr->value << endl;
101
102        // Move to the next node.
103        nodePtr = nodePtr->next;
104    }

```

```

105 }
106
107
//*****
**
108 // The insertNode function inserts a node
with *
109 // newValue copied to its value member.
*
110
//*****
**
111
112 template <class T>
113 void LinkedList<T>::insertNode(T newValue)
114 {
115     ListNode<T> *newNode; // A
new node
116     ListNode<T> *nodePtr; //
To traverse the list
117     ListNode<T> *previousNode = nullptr; //
The previous node
118
119     // Allocate a new node and store newValue
there.
120     newNode = new ListNode<T>(newValue);
121

```

```
122     // If there are no nodes in the list
123     // make newNode the first node.
124     if (!head)
125     {
126         head = newNode;
127         newNode->next = nullptr;
128     }
129     else // Otherwise, insert newNode.
130     {
131         // Position nodePtr at the head of
132         list.
133
134         // Initialize previousNode to
135         nullptr.
136
137         // Skip all nodes whose value is less
138         than newValue.
139         while (nodePtr != nullptr &&
140             nodePtr->value < newValue)
141         {
142             previousNode = nodePtr;
143             nodePtr = nodePtr->next;
144         }
145
146         // If the new node is to be the 1st
```

```

in the list,
145         // insert it before all other nodes.
146         if (previousNode == nullptr)
147         {
148             head = newNode;
149             newNode->next = nodePtr;
150         }
151         else // Otherwise insert after the
previous node.
152         {
153             previousNode->next = newNode;
154             newNode->next = nodePtr;
155         }
156     }
157 }
158
159
//*****
*****
160 // The deleteNode function searches for a
node *
161 // with searchValue as its value. The node,
if found, *
162 // is deleted from the list and from memory.
*
163
//*****

```

```
*****
164
165  template <class T>
166  void LinkedList<T>::deleteNode(T searchValue)
167  {
168      ListNode<T> *nodePtr;      // To traverse
the list
169      ListNode<T> *previousNode; // To point
to the previous node
170
171      // If the list is empty, do nothing.
172      if (!head)
173          return;
174
175      // Determine if the first node is the
one.
176      if (head->value == searchValue)
177      {
178          nodePtr = head->next;
179          delete head;
180          head = nodePtr;
181      }
182      else
183      {
184          // Initialize nodePtr to head of list
185          nodePtr = head;
186
```



```
187         // Skip all nodes whose value member
is
188         // not equal to num.
189         while (nodePtr != nullptr && nodePtr-
>value != searchValue)
190         {
191             previousNode = nodePtr;
192             nodePtr = nodePtr->next;
193         }
194
195         // If nodePtr is not at the end of
the list,
196         // link the previous node to the node
after
197         // nodePtr, then delete nodePtr.
198         if (nodePtr)
199         {
200             previousNode->next = nodePtr-
>next;
201             delete nodePtr;
202         }
203     }
204 }
205
206
//*****
**
```

```

207 // Destructor
*
208 // This function deletes every node in the
list. *
209
//*****
**
210
211 template <class T>
212 LinkedList<T>::~~LinkedList()
213 {
214     ListNode<T> *nodePtr; // To traverse the
list
215     ListNode<T> *nextNode; // To point to the
next node
216
217     // Position nodePtr at the head of the
list.
218     nodePtr = head;
219
220     // While nodePtr is not at the end of the
list...
221     while (nodePtr != nullptr)
222     {
223         // Save a pointer to the next node.
224         nextNode = nodePtr->next;
225


```

```
226         // Delete the current node.
227         delete nodePtr;
228
229         // Position nodePtr at the next node.
230         nodePtr = nextNode;
231     }
232 }
233 #endif
```

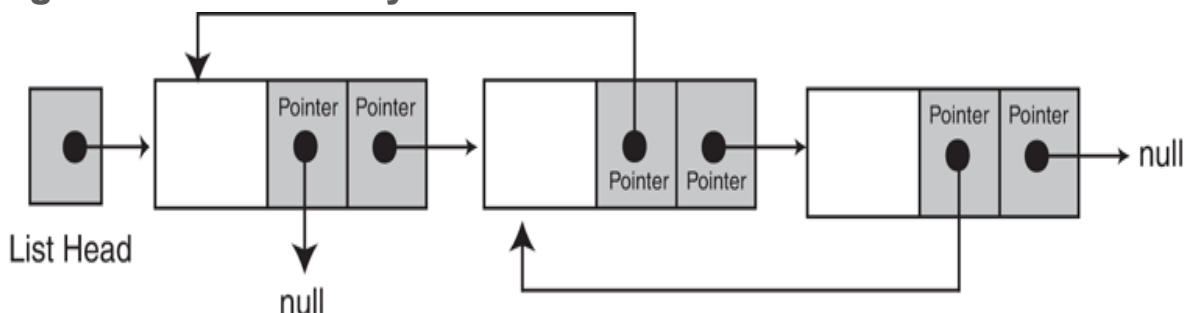
## 18.4 Variations of the Linked List

### Concept:

There are many ways to link dynamically allocated data structures together. Two variations of the linked list are the doubly linked list and the circular linked list.

The linked list examples we have discussed are considered *singly linked lists*. Each node is linked to a single other node. A variation of this is the *doubly linked list*. In this type of list, each node points not only to the next node, but also to the previous one. This is illustrated in [Figure 18-18](#) .

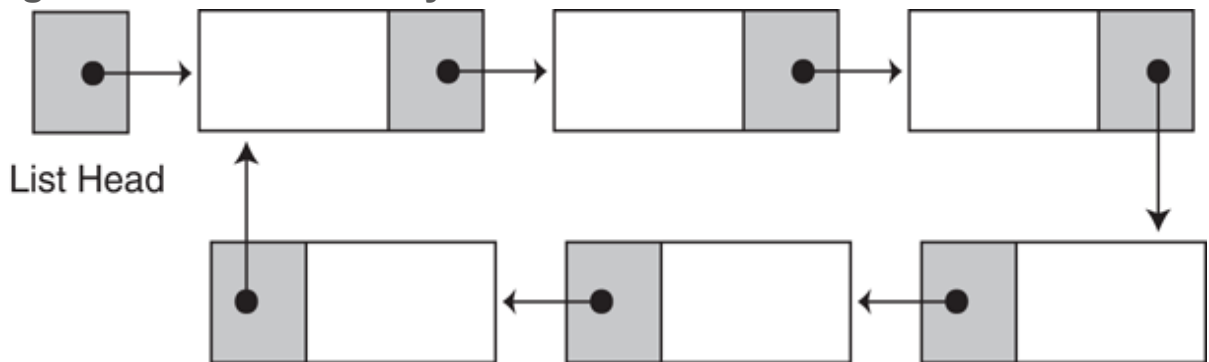
**Figure 18-18** A doubly linked list



In [Figure 18-18](#), the last node and the first node in the list have pointers to the null address. When the program traverses the list, it knows when it has reached either end.

Another variation is the *circularly linked list*. The last node in this type of list points to the first, as shown in [Figure 18-19](#).

**Figure 18-19** A circularly linked list



## 18.5 The STL `list` and `forward_list` Containers

### Concept:

The Standard Template Library provides two containers that are implemented as linked lists. The `list` container is a doubly linked list, and the `forward_list` container is a singly linked list.

The `list` container, found in the Standard Template Library, is implemented as a doubly linked list, and the `forward_list` container is implemented as a singly linked list. These containers can perform insertion and emplacement operations quicker than `vector`s because linked lists do not have to shift their existing elements in memory when a new element is added. The `list` and `forward_list` containers are also efficient at adding elements at their back because they have a built-in pointer to the last element in the list (no traversal required).

A disadvantage of the `list` and `forward_list` containers, compared to other sequence containers, is that you cannot use an index to access a list element. If you want to access an element that is in the middle of a `list` or `forward_list`, you have to step through each element until you reach the one you are looking for.

# The `list` Container

To use the `list` class, you need to `#include` the `<list>` header file in your program. Then, you can define a `list` object using one of the four `list` constructors. [Table 18-1](#) shows the general format of a `list` definition statement using each constructor. [Table 18-2](#) lists many (but not all) of the `list` class's member functions.

**Table 18-1** `list` Definition Statements

**Table 18-2** Many of the `list` Member Functions

[Program 18-6](#) demonstrates some simple operations with the `list` container.



## Program 18-6

```
1 // This program demonstrates the STL list
container.
2 #include <iostream>
3 #include <list>
4 using namespace std;
5
6 int main()
7 {
8     // Define an empty list.
9     list<int> myList;
10
11     // Add some values to the list.
12     for (int x = 0; x < 100; x += 10)
13         myList.push_back(x);
14
15     // Use an iterator to display the values.
16     for (auto it = myList.begin(); it !=
myList.end(); it++)
17         cout << *it << " ";
18     cout << endl;
19
20     // Now reverse the order of the elements.
21     myList.reverse();
```

```
22
23     // Display the values again, with a range-
based for loop
24     for (auto element : myList)
25         cout << element << " ";
26     cout << endl;
27
28     return 0;
29 }
```

## Program Output

```
0 10 20 30 40 50 60 70 80 90
90 80 70 60 50 40 30 20 10 0
```

# The `forward_list` Container

Because a `forward_list` is implemented as a singly linked list, each node keeps only one pointer: a pointer to the next node. Compared to a `list` container, which keeps two pointers per node (one to the next node, and one to the previous node), a `forward_list` uses less memory than a `list`. However, you can step only forward through a `forward_list`. If you need to move both forward and backward, you will need to use a `list` container.

The `forward_list` container provides most of the same member functions as the `list` container, with a few exceptions. You can find documentation for the `forward_list` container with a good online reference site, such as [www.cppreference.com](http://www.cppreference.com) or [www.cplusplus.com](http://www.cplusplus.com).

# Review Questions and Exercises

## Short Answer

1. What are some of the advantages that linked lists have over arrays?
2. What advantage does a linked list have over the STL `vector`?
3. What is a list head?
4. What is a self-referential data structure?
5. How is the end of a linked list usually signified?
6. Name five basic linked list operations.
7. What is the difference between appending a node and inserting a node?
8. What does “traversing the list” mean?
9. What are the two steps required to delete a node from a linked list?
10. What is the advantage of using a template to implement a linked list?
11. What is a singly linked list? What is a doubly linked list? What is a circularly linked list?
12. What type of linked list is the STL `list` container? What type of linked list is the STL `forward_list` container?

# Fill-in-the-Blank

13. The \_\_\_\_\_ points to the first node in a linked list.
14. A data structure that points to an object of the same type as itself is known as a(n) \_\_\_\_\_ data structure.
15. After creating a linked list's head pointer, you should make sure it points to \_\_\_\_\_ before using it in any operations.
16. \_\_\_\_\_ a node means adding it to the end of a list.
17. \_\_\_\_\_ a node means adding it to a list, but not necessarily to the end.
18. \_\_\_\_\_ a list means traveling through the list.
19. In a(n) \_\_\_\_\_ list, the last node has a pointer to the first node.
20. In a(n) \_\_\_\_\_ list, each node has a pointer to the one before it and the one after it.

# Algorithm Workbench

21. Consider the following code:

```
struct ListNode
{
    int value;
    struct ListNode *next;
};

ListNode *head; // List head pointer
```

Assume a linked list has been created and `head` points to the first node. Write code that traverses the list displaying the contents of each node's `value` member.

22. Write code that destroys the linked list described in Question 21.
23. Write code that defines an STL `list` container for holding `float` values.
24. Write code that stores the values 12.7, 9.65, 8.72, and 4.69 in the `list` container you defined for Question 23.
25. Write code that reverses the order of the items you stored in the `list` container in Question 24.

# True or False

26. T F The programmer must know in advance how many nodes will be needed in a linked list.
27. T F It is not necessary for each node in a linked list to have a self-referential pointer.
28. T F In physical memory, the nodes in a linked list may be scattered around.
29. T F When the head pointer points to `nullptr`, it signifies an empty list.
30. T F Linked lists are not superior to STL vectors.
31. T F Deleting a node in a linked list is a simple matter of using the `delete` operator to free the node's memory.
32. T F A class that builds a linked list should destroy the list in the class destructor.

# Find the Errors

Each of the following member functions has errors in the way it performs a linked list operation. Find as many mistakes as you can.

33. `void NumberList::appendNode(double num)`
- ```
{  
    ListNode *newNode, *nodePtr;  
    // Allocate a new node & store num  
    newNode = new listNode;  
    newNode->value = num;  
    // If there are no nodes in the list  
    // make newNode the first node.  
    if (!head)  
        head = newNode;  
    else // Otherwise, insert newNode.  
    {  
        // Find the last node in the list.  
        while (nodePtr->next)  
            nodePtr = nodePtr->next;  
        // Insert newNode as the last node.  
        nodePtr->next = newNode;  
    }  
}
```
34. `void NumberList::deleteNode(double num)`



```

{
ListNode *nodePtr, *previousNode;
// If the list is empty, do nothing.
if (!head)
return;
// Determine if the first node is the one.
if (head->value == num)
delete head;
else
{
// Initialize nodePtr to head of list.
nodePtr = head;
// Skip all nodes whose value member is
// not equal to num.
while (nodePtr->value != num)
{
previousNode = nodePtr;
nodePtr = nodePtr->next;
}
// Link the previous node to the node after
// nodePtr, then delete nodePtr.
previousNode->next = nodePtr->next;
delete nodePtr;
}
}

```

35. `NumberList::~~NumberList()`

```
{  
    ListNode *nodePtr, *nextNode;  
    nodePtr = head;  
    while (nodePtr != nullptr)  
    {  
        nextNode = nodePtr->next;  
        nodePtr->next = nullptr;  
        nodePtr = nextNode;  
    }  
}
```

# Programming Challenges

## 1. Your Own Linked List

Design your own linked list class to hold a series of integers. The class should have member functions for appending, inserting, and deleting nodes. Don't forget to add a destructor that destroys the list. Demonstrate the class with a driver program.

## 2. List Print

Modify the linked list class you created in Programming Challenge 1 to add a `print` member function. The function should display all the values in the linked list. Test the class by starting with an empty list, adding some elements, then printing the resulting list out.

## 3. List Copy Constructor

Modify your linked list class of Programming Challenges 1 and 2 to add a copy constructor. Test your class by making a list, making a copy of the list, then displaying the values in the copy.

## 4. List Reverse

Modify the linked list class you created in the previous programming challenges by adding a member function named `reverse` that rearranges the nodes in the list so their order is reversed. Demonstrate the function in a simple driver program.

## 5. List Search

Modify the linked list class you created in the previous programming challenges to include a member function named `search` that returns the position of a specific value,  $x$ , in the linked list. The first node in the list is at position 0, the second node is at position 1, and so on. If  $x$  is not found on the list, the search should return  $-1$ . Test the new member function using an appropriate driver program.

## 6. Member Insertion by Position



### Solving the Member Insertion by Position Problem

Modify the list class you created in the previous programming challenges by adding a member function for inserting a new item at a specified position. A position of 0 means that the value will become the first item on the list, a position of 1 means the value will become the second item on the list, and so on. A position equal to or greater than the length of the list means the value is placed at the end of the list.

## 7. Member Removal by Position

Modify the list class you created in the previous programming challenges by adding a member function for deleting a node at a specified position. A value of 0 for the position means the first node in the list (the current head) is deleted. The function does nothing if the specified position is greater than or equal to the length of the list.

#### 8. List Template

Create a list class template based on the list class you created in the previous programming challenges.

#### 9. Rainfall Statistics Modification

Modify Programming Challenge 2 in [Chapter 7](#) (Rainfall Statistics) to let the user decide how many months of data will be entered. Use a linked list instead of an array to hold the monthly data.

#### 10. Payroll Modification

Modify Programming Challenge 9 in [Chapter 7](#) (Payroll) to use three linked lists instead of three arrays to hold the employee IDs, hours worked, and wages. When the program starts, it should ask the user to enter the employee IDs. There should be no limit on the number of IDs the user can enter.

#### 11. List Search

Modify the `LinkedList` template shown in this chapter to include a member function named `search`. The function should search the list for a specified value. If the value is found, it should return a number indicating its position in the list. (The first node is node 1, the second node is node 2, and so forth.) If the value is not found, the function should return 0. Demonstrate the function in a driver program.

## 12. Double Merge

Modify the `NumberList` class shown in this chapter to include a member function named `mergeArray`. The `mergeArray` function should take an array of `double`s as its first argument, and an integer as its second argument. (The second argument will specify the size of the array being passed into the first argument.)

The function should merge the values in the array into the linked list. The value in each element of the array should be inserted (not appended) into the linked list. When the values are inserted, they should be in numerical order. Demonstrate the function with a driver program. When you are satisfied with the function, incorporate it into the `LinkedList` template.

## 13. Rainfall Statistics Modification #2

Modify the program you wrote for Programming Challenge 9 so it saves the data in the linked list to a file. Write a second program that reads the data from the file into a linked list and displays it on the screen.

## 14. Overloaded `[]` Operator

Modify the linked list class you created in Programming Challenge 1 (or the `LinkedList` template presented in this chapter) by adding an overloaded `[]` operator function. This will give the linked list the ability to access nodes using a subscript, like an array. The subscript 0 will reference the first node in the list, the subscript 1 will reference the second node in the list, and so forth. The subscript of the last node will be the number of nodes minus 1. If an invalid subscript is used, the function should throw an exception.

## 15. `pop` and `push` Member Functions

The STL `list` container has member functions named `pop_back`, `pop_front`, `push_back`, and `push_front`, as described in [Table 18-2](#). Modify the linked list class you created in Programming Challenge 1 (or the `LinkedList` template presented in this chapter) by adding your own versions of these member functions.

---

# Chapter 19 Stacks and Queues

---

## Topics

19.1 Introduction to the Stack ADT [□](#)

19.2 Dynamic Stacks [□](#)

19.3 The STL `stack` Container [□](#)

19.4 Introduction to the Queue ADT [□](#)

19.5 Dynamic Queues [□](#)

19.6 The STL `deque` and `queue` Containers [□](#)



## 19.1 Introduction to the Stack ADT

### Concept:

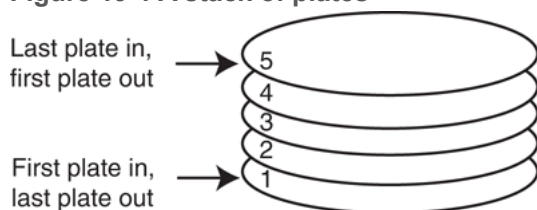
A stack is a data structure that stores and retrieves items in a last-in, first-out manner.

## Definition

Like an array or a linked list, a stack is a data structure that holds a sequence of elements. Unlike arrays and lists, however, stacks are *last-in, first-out (LIFO)* structures. This means when a program retrieves elements from a stack, the last element inserted into the stack is the first one retrieved (and likewise, the first element inserted is the last one retrieved).

When visualizing the way a stack works, think of a stack of plates at the beginning of a cafeteria line. When a cafeteria worker replenishes the supply of plates, the first one he or she puts on the stack is the last one taken off. This is illustrated in [Figure 19-1](#).

**Figure 19-1 A stack of plates**



The LIFO characteristic of a stack of plates in a cafeteria is also the primary characteristic of a stack data structure. The last data element placed on the stack is the first data retrieved from the stack.

## Applications of Stacks

Stacks are useful data structures for algorithms that work first with the last saved element of a series. For example, computer systems use stacks while executing programs. When a function is called, they save the program's return address on a stack. They also create local variables on a stack. When the function terminates, the local variables are removed from the stack and the return address is retrieved. Also, some calculators use a stack for performing mathematical operations.

# Static and Dynamic Stacks

There are two types of stack data structures: static and dynamic. Static stacks have a fixed size and are implemented as arrays. Dynamic stacks grow in size as needed and are implemented as linked lists. In this section, you will see examples of both static and dynamic stacks.

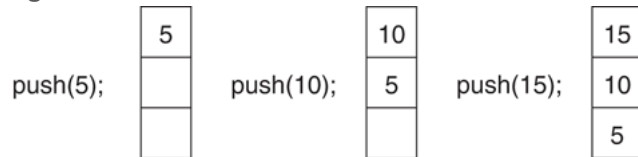
# Stack Operations

A stack has two primary operations: *push* and *pop*. The push operation causes a value to be stored, or pushed onto the stack. For example, suppose we have an empty integer stack that is capable of holding a maximum of three values. With that stack, we execute the following push operations.

```
push(5);  
push(10);  
push(15);
```

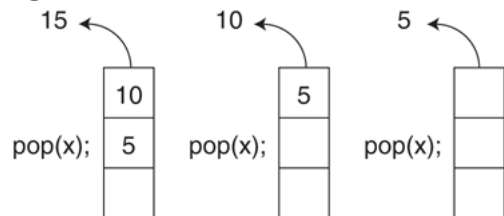
Figure 19-2 illustrates the state of the stack after each of these push operations.

Figure 19-2 State of the stack



The pop operation retrieves (and hence, removes) a value from the stack. Suppose, we execute three consecutive pop operations on the stack shown in Figure 19-2. Figure 19-3 depicts the results.

Figure 19-3 State of the stack



As you can see from Figure 19-3, the last pop operation leaves the stack empty.

For a static stack (one with a fixed size), we will need a Boolean `isFull` operation. The `isFull` operation returns `true` if the stack is full, and `false` otherwise. This operation is necessary to prevent a stack overflow in the event a push operation is attempted when all the stack's elements have values stored in them.

For both static and dynamic stacks, we will need a Boolean `isEmpty` operation. The `isEmpty` operation returns `true` when the stack is empty, and `false` otherwise. This prevents an error from occurring when a pop operation is attempted on an empty stack.

# A Static Stack Class

Now we examine a class, `IntStack`, that stores a static stack of integers and performs the `isFull` and `isEmpty` operations. The class has the member variables described in [Table 19-1](#).

## Table 19-1 The `IntStack` Class's Member Variables

The class's member functions are listed in [Table 19-2](#).

## Table 19-2 The `IntStack` Class's Member Functions



### **Note:**

Even though the constructor dynamically allocates the stack array, it is still a static stack. The size of the stack does not change once it is allocated.

The code for the class is as follows:

## Contents of `IntStack.h`

```
1 // Specification file for the IntStack class
2 #ifndef INTSTACK_H
3 #define INTSTACK_H
4
5 class IntStack
6 {
7     private:
8         int *stackArray; // Pointer to the stack array
9         int stackSize;   // The stack size
10        int top;          // Indicates the top of the stack
11
12    public:
13        // Constructor
14        IntStack(int);
15
16        // Copy constructor
17        IntStack(const IntStack &);
18
19        // Destructor
20        ~IntStack();
21
22        // Stack operations
23        void push(int);
24        void pop(int &);
25        bool isFull() const;
26        bool isEmpty() const;
27 };
28 #endif
```

## Contents of `IntStack.cpp`

```
1 // Implementation file for the IntStack class
2 #include <iostream>
3 #include "IntStack.h"
4 using namespace std;
5
6 //*****
7 // Constructor *
8 // This constructor creates an empty stack. The *
9 // size parameter is the size of the stack. *
10 //*****
11
12 IntStack::IntStack(int size)
13 {
14     stackArray = new int[size];
15     stackSize = size;
16     top = -1;
17 }
18
19 //*****
20 // Copy constructor *
21 //*****
22
23 IntStack::IntStack(const IntStack &obj)
24 {
25     // Create the stack array.
26     if (obj.stackSize > 0)
27         stackArray = new int[obj.stackSize];
28     else
29         stackArray = nullptr;
30
31     // Copy the stackSize attribute.
32     stackSize = obj.stackSize;
33
34     // Copy the stack contents.
35     for (int count = 0; count < stackSize; count++)
36         stackArray[count] = obj.stackArray[count];
37
```

```

38     // Set the top of the stack.
39     top = obj.top;
40 }
41
42 //*****
43 // Destructor *
44 //*****
45
46 IntStack::~IntStack()
47 {
48     delete [] stackArray;
49 }
50
51 //*****
52 // Member function push pushes the argument onto *
53 // the stack. *
54 //*****
55
56 void IntStack::push(int num)
57 {
58     if (isFull())
59     {
60         cout << "The stack is full.\n";
61     }
62     else
63     {
64         top++;
65         stackArray[top] = num;
66     }
67 }
68
69 //*****
70 // Member function pop pops the value at the top *
71 // of the stack off, and copies it into the variable *
72 // passed as an argument. *
73 //*****
74
75 void IntStack::pop(int &num)
76 {
77     if (isEmpty())
78     {

```

```

79         cout << "The stack is empty.\n";
80     }
81     else
82     {
83         num = stackArray[top];
84         top--;
85     }
86 }
87
88 //*****
89 // Member function isFull returns true if the stack *
90 // is full, or false otherwise. *
91 //*****
92
93 bool IntStack::isFull() const
94 {
95     bool status;
96
97     if (top == stackSize - 1)
98         status = true;
99     else
100        status = false;
101
102     return status;
103 }
104
105 //*****
106 // Member function isEmpty returns true if the stack *
107 // is empty, or false otherwise. *
108 //*****
109
110 bool IntStack::isEmpty() const
111 {
112     bool status;
113
114     if (top == -1)
115         status = true;
116     else
117         status = false;
118

```



```
119     return status;
120 }
```

The class has two constructors, one that accepts an argument for the stack size (lines 12 through 17 of `IntStack.cpp`), and a copy constructor (lines 23 through 40). The first constructor dynamically allocates the stack array in line 14, initializes the `stackSize` member variable in line 15, and initializes the `top` member variable in line 16. Remember items are stored to and retrieved from the top of the stack. In this class, the top of the stack is actually the end of the array. The variable `top` is used to mark the top of the stack by holding the subscript of the last element. When `top` holds `-1`, it indicates the stack is empty. (See the `isEmpty` function, which returns `true` if `top` is `-1`, or `false` otherwise.) The stack is full when `top` is at the maximum subscript, which is `stackSize - 1`. This is the value for which `isFull` tests. It returns `true` if the stack is full, or `false` otherwise.

**Program 19-1**  is a simple driver that demonstrates the `IntStack` class.

## Program 19-1

```
1 // This program demonstrates the IntStack class.
2 #include <iostream>
3 #include "IntStack.h"
4 using namespace std;
5
6 int main()
7 {
8     int catchVar; // To hold values popped off the stack
9
10    // Define a stack object to hold 5 values.
11    IntStack stack(5);
12
13    // Push the values 5, 10, 15, 20, and 25 onto the stack.
14    cout << "Pushing 5\n";
15    stack.push(5);
16    cout << "Pushing 10\n";
17    stack.push(10);
18    cout << "Pushing 15\n";
19    stack.push(15);
20    cout << "Pushing 20\n";
21    stack.push(20);
22    cout << "Pushing 25\n";
23    stack.push(25);
24
25    // Pop the values off the stack.
26    cout << "Popping...\n";
27    stack.pop(catchVar);
28    cout << catchVar << endl;
29    stack.pop(catchVar);
30    cout << catchVar << endl;
31    stack.pop(catchVar);
32    cout << catchVar << endl;
33    stack.pop(catchVar);
34    cout << catchVar << endl;
35    stack.pop(catchVar);
36    cout << catchVar << endl;
```

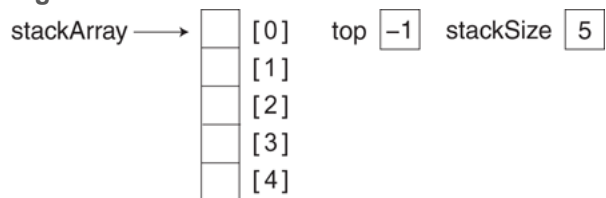
```
37     return 0;
38 }
```

### Program Output

```
Pushing 5
Pushing 10
Pushing 15
Pushing 20
Pushing 25
Popping...
25
20
15
10
5
```

In [Program 19-1](#), the constructor is called with the argument 5. This sets up the member variables as shown in [Figure 19-4](#). Because `top` is set to `-1`, the stack is empty.

**Figure 19-4 State of the stack**



[Figure 19-5](#) shows the state of the member variables after the `push` function is called the first time (with 5 as its argument). The top of the stack is now at element 0.

**Figure 19-5 State of the stack**

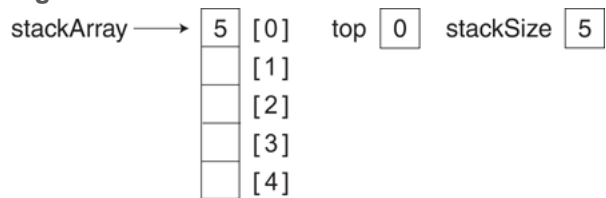
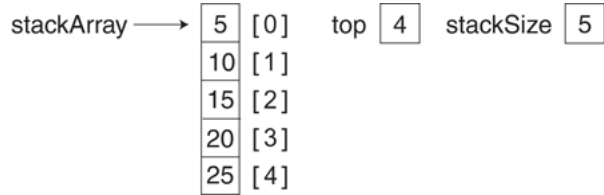


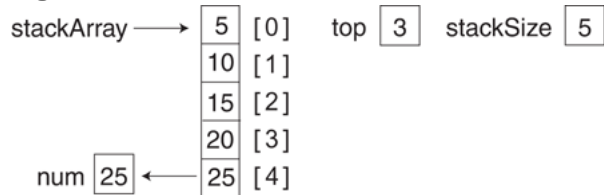
Figure 19-6 shows the state of the member variables after all five calls to the `push` function. Now, the top of the stack is at element 4, and the stack is full.

Figure 19-6 State of the stack



Notice the `pop` function uses a reference parameter, `num`. The value that is popped off the stack is copied into `num` so it can be used later in the program. Figure 19-7 depicts the state of the class members, and the `num` parameter, just after the first value is popped off the stack.

Figure 19-7 State of the stack



The program continues to call the `pop` function until all the values have been retrieved from the stack.

# Implementing Other Stack Operations

More complex operations may be built on the basic stack class previously shown. In this section, we will discuss a class, `MathStack`, that is derived from `IntStack`. The `MathStack` class has two member functions: `add()` and `sub()`. The `add()` function pops the first two values off the stack, adds them together, then pushes the sum onto the stack. The `sub()` function pops the first two values off the stack, subtracts the second value from the first, then pushes the difference onto the stack. The class declaration is as follows:

## Contents of `MathStack.h`

```
1 // Specification file for the MathStack class
2 #ifndef MATHSTACK_H
3 #define MATHSTACK_H
4 #include "IntStack.h"
5
6 class MathStack : public IntStack
7 {
8 public:
9     // Constructor
10    MathStack(int s) : IntStack(s) {}
11
12    // MathStack operations
13    void add();
14    void sub();
15 };
16 #endif
```

The definitions of the member functions are shown here:

## Contents of `MathStack.cpp`

```
1 // Implementation file for the MathStack class
2 #include "MathStack.h"
3
4 //*****
5 // Member function add. add pops *
6 // the first two values off the stack and *
7 // adds them. The sum is pushed onto the stack. *
8 //*****
9
10 void MathStack::add()
11 {
12     int num, sum;
13
14     // Pop the first two values off the stack.
15     pop(sum);
16     pop(num);
17
18     // Add the two values, store in sum.
19     sum += num;
20
21     // Push sum back onto the stack.
22     push(sum);
23 }
24
25 //*****
26 // Member function sub. sub pops the *
27 // first two values off the stack. The *
28 // second value is subtracted from the *
29 // first value. The difference is pushed *
30 // onto the stack. *
31 //*****
32
33 void MathStack::sub()
34 {
35     int num, diff;
36
37     // Pop the first two values off the stack.
```

```
38     pop(diff);
39     pop(num);
40
41     // Subtract num from diff.
42     diff -= num;
43
44     // Push diff back onto the stack.
45     push(diff);
46 }
```

The class is demonstrated in [Program 19-2](#), a simple driver.

## Program 19-2

```
1 // This program demonstrates the MathStack class.
2 #include <iostream>
3 #include "MathStack.h"
4 using namespace std;
5
6 int main()
7 {
8     int catchVar; // To hold values popped off the stack
9
10    // Create a MathStack object.
11    MathStack stack(5);
12
13    // Push 3 and 6 onto the stack.
14    cout << "Pushing 3\n";
15    stack.push(3);
16    cout << "Pushing 6\n";
17    stack.push(6);
18
19    // Add the two values.
20    stack.add();
21
22    // Pop the sum off the stack and display it.
23    cout << "The sum is ";
24    stack.pop(catchVar);
25    cout << catchVar << endl << endl;
26
27    // Push 7 and 10 onto the stack
28    cout << "Pushing 7\n";
29    stack.push(7);
30    cout << "Pushing 10\n";
31    stack.push(10);
32
33    // Subtract 7 from 10.
34    stack.sub();
35
36    // Pop the difference off the stack and display it.
37    cout << "The difference is ";
```



```
38     stack.pop(catchVar);  
39     cout << catchVar << endl;  
40     return 0;  
41 }
```

### Program Output

```
Pushing 3  
Pushing 6  
The sum is 9  
  
Pushing 7  
Pushing 10  
The difference is 3
```

It will be left as a Programming Challenge for you to implement the `mult()`, `div()`, and `mod()` functions that will complete the `MathStack` class.

# A Static Stack Template

The stack classes shown previously in this chapter work only with integers. A stack template can be easily designed to work with any data type, as shown by the following example:

## Contents of `Stack.h`

```
1 #ifndef STACK_H
2 #define STACK_H
3 #include <iostream>
4 using namespace std;
5
6 // Stack template
7 template <class T>
8 class Stack
9 {
10 private:
11     T *stackArray;
12     int stackSize;
13     int top;
14
15 public:
16     // Constructor
17     Stack(int);
18
19     // Copy constructor
20     Stack(const Stack&);
21
22     // Destructor
23     ~Stack();
24
25     // Stack operations
26     void push(T);
27     void pop(T &);
28     bool isFull();
29     bool isEmpty();
30 };
31
32 /*******
33 // Constructor *
34 /*******
35
36 template <class T>
37 Stack<T>::Stack(int size)
```

```

38 {
39     stackArray = new T[size];
40     stackSize = size;
41     top = -1;
42 }
43
44 //*****
45 // Copy constructor *
46 //*****
47
48 template <class T>
49 Stack<T>::Stack(const Stack &obj)
50 {
51     // Create the stack array.
52     if (obj.stackSize > 0)
53         stackArray = new T[obj.stackSize];
54     else
55         stackArray = nullptr;
56
57     // Copy the stackSize attribute.
58     stackSize = obj.stackSize;
59
60     // Copy the stack contents.
61     for (int count = 0; count < stackSize; count++)
62         stackArray[count] = obj.stackArray[count];
63
64     // Set the top of the stack.
65     top = obj.top;
66 }
67
68 //*****
69 // Destructor *
70 //*****
71
72 template <class T>
73 Stack<T>::~Stack()
74 {
75     if (stackSize > 0)
76         delete [] stackArray;
77 }
78

```

```


79 //*****
80 // Member function push pushes the argument onto *
81 // the stack. *
82 //*****
83
84 template <class T>
85 void Stack<T>::push(T item)
86 {
87     if (isFull())
88     {
89         cout << "The stack is full.\n";
90     }
91     else
92     {
93         top++;
94         stackArray[top] = item;
95     }
96 }
97
98 //*****
99 // Member function pop pops the value at the top *
100 // of the stack off, and copies it into the variable *
101 // passed as an argument. *
102 //*****
103
104 template <class T>
105 void Stack<T>::pop(T &item)
106 {
107     if (isEmpty())
108     {
109         cout << "The stack is empty.\n";
110     }
111     else
112     {
113         item = stackArray[top];
114         top--;
115     }
116 }
117
118 //*****
119 // Member function isFull returns true if the stack *

```

```

120 // is full, or false otherwise. *
121 //*****
122
123 template <class T>
124 bool Stack<T>::isFull()
125 {
126     bool status;
127
128     if (top == stackSize - 1)
129         status = true;
130     else
131         status = false;
132
133     return status;
134 }
135
136 //*****
137 // Member function isEmpty returns true if the stack *
138 // is empty, or false otherwise. *
139 //*****
140
141 template <class T>
142 bool Stack<T>::isEmpty()
143 {
144     bool status;
145
146     if (top == -1)
147         status = true;
148     else
149         status = false;
150
151     return status;
152 }
153 #endif

```

**Program 19-3**  demonstrates the `Stack` template. It creates a stack of strings, then presents a menu that allows the user to push an item onto the stack, pop an item from the stack, or quit the program.

## Program 19-3

```
1 // This program demonstrates the Stack template.
2 #include <iostream>
3 #include <string>
4 #include "Stack.h"
5 using namespace std;
6
7 // Constants for the menu choices
8 const int PUSH_CHOICE = 1,
9         POP_CHOICE = 2,
10        QUIT_CHOICE = 3;
11
12 // Function prototypes
13 void menu(int &);
14 void getStackSize(int &);
15 void pushItem(Stack<string>&);
16 void popItem(Stack<string>&);
17
18 int main()
19 {
20     int stackSize; // The stack size
21     int choice;    // To hold a menu choice
22
23     // Get the stack size.
24     getStackSize(stackSize);
25
26     // Create the stack.
27     Stack<string> stack(stackSize);
28
29     do
30     {
31         // Get the user's menu choice.
32         menu(choice);
33
34         // Perform the user's choice.
35         if (choice != QUIT_CHOICE)
36         {
37             switch (choice)
```

```

38     {
39         case PUSH_CHOICE:
40             pushItem(stack);
41             break;
42         case POP_CHOICE:
43             popItem(stack);
44     }
45 }
46 } while (choice != QUIT_CHOICE);
47
48 return 0;
49 }
50
51 //*****
52 // The getStackSize function gets the desired *
53 // stack size, which is assigned to the *
54 // reference parameter. *
55 //*****
56 void getStackSize(int &size)
57 {
58     // Get the desired stack size.
59     cout << "How big should I make the stack? ";
60     cin >> size;
61
62     // Validate the size.
63     while (size < 1)
64     {
65         cout << "Enter 1 or greater: ";
66         cin >> size;
67     }
68 }
69
70 //*****
71 // The menu function displays the menu and gets *
72 // the user's choice, which is assigned to the *
73 // reference parameter. *
74 //*****
75 void menu(int &choice)
76 {
77     // Display the menu and get the user's choice.
78     cout << "\nWhat do you want to do?\n"

```



```

79     << PUSH_CHOICE
80     << " - Push an item onto the stack\n"
81     << POP_CHOICE
82     << " - Pop an item off the stack\n"
83     << QUIT_CHOICE
84     << " - Quit the program\n"
85     << "Enter your choice: ";
86     cin >> choice;
87
88     // Validate the choice
89     while (choice < PUSH_CHOICE || choice > QUIT_CHOICE)
90     {
91         cout << "Enter a valid choice: ";
92         cin >> choice;
93     }
94 }
95
96 //*****
97 // The pushItem function gets an item from the *
98 // user and pushes it onto the stack. *
99 //*****
100 void pushItem(Stack<string> &stack)
101 {
102     string item;
103
104     // Get an item to push onto the stack.
105     cin.ignore();
106     cout << "\nEnter an item: ";
107     getline(cin, item);
108     stack.push(item);
109 }
110
111 //*****
112 // The popItem function pops an item from the stack *
113 //*****
114 void popItem(Stack<string> &stack)
115 {
116     string item = "";
117
118     // Pop the item.
119     stack.pop(item);

```

```
120
121     // Display the item.
122     if (item != "")
123         cout << item << " was popped.\n";
124 }
```

**Program Output with Example Input Shown in Bold**

How big should I make the stack? **3** Enter

What do you want to do?

- 1 - Push an item onto the stack
- 2 - Pop an item off the stack
- 3 - Quit the program

Enter your choice: **1** Enter

Enter an item: **The Adventures of Huckleberry Finn** Enter

What do you want to do?

- 1 - Push an item onto the stack
- 2 - Pop an item off the stack
- 3 - Quit the program

Enter your choice: **1** Enter

Enter an item: **All Quiet on the Western Front** Enter

What do you want to do?

- 1 - Push an item onto the stack
- 2 - Pop an item off the stack
- 3 - Quit the program

Enter your choice: **1** Enter

Enter an item: **Brave New World** Enter

What do you want to do?

- 1 - Push an item onto the stack
- 2 - Pop an item off the stack
- 3 - Quit the program

Enter your choice: **2** Enter

Brave New World was popped.

What do you want to do?

- 1 - Push an item onto the stack
- 2 - Pop an item off the stack
- 3 - Quit the program

Enter your choice: **2** Enter

All Quiet on the Western Front was popped.

What do you want to do?

- 1 - Push an item onto the stack
- 2 - Pop an item off the stack

3 - Quit the program

Enter your choice: **2** Enter

The Adventures of Huckleberry Finn was popped.

What do you want to do?

1 - Push an item onto the stack

2 - Pop an item off the stack

3 - Quit the program

Enter your choice: **2** Enter

The stack is empty.

What do you want to do?

1 - Push an item onto the stack

2 - Pop an item off the stack

3 - Quit the program

Enter your choice: **3** Enter

## 19.2 Dynamic Stacks

### Concept:

A stack may be implemented as a linked list, and expand or shrink with each `push` or `pop` operation.

A dynamic stack is built on a linked list instead of an array. A linked list-based stack offers two advantages over an array-based stack. First, there is no need to specify the starting size of the stack. A dynamic stack simply starts as an empty linked list, then expands by one node each time a value is pushed. Second, a dynamic stack will never be full, as long as the system has enough free memory.

In this section, we will look at a dynamic stack class, `DynIntStack`. This class is a dynamic version of the `IntStack` class previously discussed. The class declaration is shown here:

## Contents of `DynIntStack.h`

```
1 // Specification file for the DynIntStack
class
2 #ifndef DYNINTSTACK_H
3 #define DYNINTSTACK_H
4
5 class DynIntStack
6 {
7 private:
8     // Structure for stack nodes
9     struct StackNode
10    {
11        int value;           // Value in the
node
12        StackNode *next;    // Pointer to the
next node
13    };
14
15    StackNode *top;         // Pointer to the
stack top
16
17 public:
18     // Constructor
19     DynIntStack()
```

```
20         { top = nullptr; }
21
22         // Destructor
23         ~DynIntStack();
24
25         // Stack operations
26         void push(int);
27         void pop(int &);
28         bool isEmpty();
29     };
30 #endif
```

The `StackNode` structure is the data type of each node in the linked list. It has a `value` member and a `next` pointer. Notice instead of a `head` pointer, a `top` pointer is defined. This member will always point to the first node in the list, which will represent the top of the stack. It is initialized to `nullptr` by the constructor, to signify the stack is empty.

The definitions of the other member functions are shown here:

## Contents of `DynIntStack.cpp`

```
1  #include <iostream>
2  #include "DynIntStack.h"
3  using namespace std;
4
5
6  //*****
7  // Destructer
8  // This function deletes every node in the
9  // list.
10 *****
11
12 DynIntStack::~DynIntStack()
13 {
14     StackNode *nodePtr = nullptr, *nextNode =
15     nullptr;
16
17     // Position nodePtr at the top of the
18     stack.
19
20     nodePtr = top;
```



```

16
17     // Traverse the list deleting each node.
18     while (nodePtr != nullptr)
19     {
20         nextNode = nodePtr->next;
21         delete nodePtr;
22         nodePtr = nextNode;
23     }
24 }
25
26
27 //*****
28 *
29 // Member function push pushes the argument
30 onto *
31 // the stack.
32 *
33 //*****
34 *
35 void DynIntStack::push(int num)
36 {
37     StackNode *newNode = nullptr; // Pointer
38     to a new node
39
40     // Allocate a new node and store num

```

```
there.  
36     newNode = new StackNode;  
37     newNode->value = num;  
38  
39     // If there are no nodes in the list  
40     // make newNode the first node.  
41     if (isEmpty())  
42     {  
43         top = newNode;  
44         newNode->next = nullptr;  
45     }  
46     else // Otherwise, insert NewNode before  
top.  
47     {  
48         newNode->next = top;  
49         top = newNode;  
50     }  
51 }  
52  
53  
//*****  
*****  
54 // Member function pop pops the value at the  
top *  
55 // of the stack off, and copies it into the  
variable *  
56 // passed as an argument.
```

```

*
57
//*****
*****
58
59 void DynIntStack::pop(int &num)
60 {
61     StackNode *temp = nullptr; // Temporary
pointer
62
63     // First make sure the stack isn't empty.
64     if (isEmpty())
65     {
66         cout << "The stack is empty.\n";
67     }
68     else // pop value off top of stack
69     {
70         num = top->value;
71         temp = top->next;
72         delete top;
73         top = temp;
74     }
75 }
76
77
//*****
*****

```

```

78 // Member function isEmpty returns true if the
stack *
79 // is empty, or false otherwise.
*
80
//*****
*****
81
82 bool DynIntStack::isEmpty()
83 {
84     bool status;
85
86     if (!top)
87         status = true;
88     else
89         status = false;
90
91     return status;
92 }

```

Let's look at the `push` operation in lines 31 through 51 of `DynIntStack.cpp`. First, in lines 36 and 37, a new node is allocated in memory, and the function argument is copied into its value member:

```
newNode = new StackNode;  
newNode->value = num;
```

Next, in line 41, an `if` statement calls the `isEmpty` function to determine whether the stack is empty:

```
if (isEmpty())  
{  
    top = newNode;  
    newNode->next = nullptr;  
}
```

If `isEmpty` returns `true`, `top` is made to point at the new node, and the new node's `next` pointer is set to `nullptr`. After these statements execute, there will be one node in the list (and one value on the stack).

If `isEmpty` returns `false` in the `if` statement, the following statements in lines 46 through 50 are executed:

```
else // Otherwise, insert newNode before top
{
    newNode->next = top;
    top = newNode;
}
```

Notice `newNode` is being inserted in the list before the node to which `top` points. The `top` pointer is then updated to point to the new node. When this is done, `newNode` is at the top of the stack.

Now, let's look at the `pop` function in lines 59 through 75. Just as the `push` function must insert nodes at the head of the list, `pop` must delete nodes at the head of the list. First, the function calls `isEmpty` in line 64 to determine whether there are any nodes in the stack. If there are none, an error message is displayed:


```
if (isEmpty())
{
    cout << "The stack is empty.\n";
}
```

If `isEmpty` returns `false`, then the following statements in lines 68 through 74 are executed.

```
else // pop value off top of stack
{
    num = top->value;
    temp = top->next;
    delete top;
    top = temp;
}
```

First, the `value` member of the top node is copied into the `num` reference parameter. This saves the value for later use in the program. Next, a temporary `StackNode` pointer, `temp`, is made to point to `top->next`. If there are other nodes in the list, this causes `temp` to point to the second node. (If there are no more nodes, this will cause `temp` to point to `nullptr`.) Now, it is safe to delete the top node. After the top node is deleted, the `top` pointer is set equal to `temp`. This action moves the top pointer down the list by one node. The node that was previously second in the list becomes first.

The `isEmpty` function, in lines 82 through 92, is simple. If `top` is a null pointer, then the list (the stack) is empty.

**Program 19-4**  is a driver that demonstrates the `DynIntStack` class.

## Program 19-4

```
1 // This program demonstrates the dynamic
stack.
2 // class DynIntClass.
3 #include <iostream>
4 #include "DynIntStack.h"
5 using namespace std;
6
7 int main()
8 {
9     int catchVar; // To hold values popped off
the stack
10
11     // Create a DynIntStack object.
12     DynIntStack stack;
13
14     // Push 5, 10, and 15 onto the stack.
15     cout << "Pushing 5\n";
16     stack.push(5);
17     cout << "Pushing 10\n";
18     stack.push(10);
19     cout << "Pushing 15\n";
20     stack.push(15);
21
```



```
22     // Pop the values off the stack and
display them.
23     cout << "Popping...\n";
24     stack.pop(catchVar);
25     cout << catchVar << endl;
26     stack.pop(catchVar);
27     cout << catchVar << endl;
28     stack.pop(catchVar);
29     cout << catchVar << endl;
30
31     // Try to pop another value off the stack.
32     cout << "\nAttempting to pop again... ";
33     stack.pop(catchVar);
34     return 0;
35 }
```

## Program Output

Pushing 5

Pushing 10

Pushing 15

Popping...

15

10

5

Attempting to pop again... The stack is  
empty.

# A Dynamic Stack Template

The dynamic stack class shown previously in this chapter works only with integers. A dynamic stack template can be easily designed to work with any data type, as shown by the following example:

## Contents of `DynamicStack.h`

```
1 #ifndef DYNAMICSTACK_H
2 #define DYNAMICSTACK_H
3 #include <iostream>
4 using namespace std;
5
6 // Stack template
7 template <class T>
8 class DynamicStack
9 {
10 private:
11     // Structure for the stack nodes
12     struct StackNode
13     {
14         T value; // Value in the
node
15         StackNode *next; // Pointer to the
next node
16     };
17
18     StackNode *top; // Pointer to the stack
top
19
20 public:
```

```

21     //Constructor
22     DynamicStack()
23     { top = nullptr; }
24
25     // Destructor
26     ~DynamicStack();
27
28     // Stack operations
29     void push(T);
30     void pop(T &);
31     bool isEmpty();
32 };
33
34
35 //*****
36
37 // Destructor
38 *
39
40 //*****
41
42 template <class T>
43 DynamicStack<T>::~~DynamicStack()
44 {
45     StackNode *nodePtr, *nextNode;
46
47     // Position nodePtr at the top of the

```

```

stack.
43     nodePtr = top;
44
45     // Traverse the list deleting each node.
46     while (nodePtr != nullptr)
47     {
48         nextNode = nodePtr->next;
49         delete nodePtr;
50         nodePtr = nextNode;
51     }
52 }
53
54
//*****
*****
55 // Member function push pushes the argument
onto      *
56 // the stack.
*
57
//*****
*****
58
59 template <class T>
60 void DynamicStack<T>::push(T item)
61 {
62     StackNode *newNode = nullptr; // Pointer

```

to a new node

```
63
64     // Allocate a new node and store num
there.
65     newNode = new StackNode;
66     newNode->value = item;
67
68     // If there are no nodes in the list
69     // make newNode the first node.
70     if (isEmpty())
71     {
72         top = newNode;
73         newNode->next = nullptr;
74     }
75     else // Otherwise, insert NewNode before
top.
76     {
77         newNode->next = top;
78         top = newNode;
79     }
80 }
81
82
//*****
*****
83 // Member function pop pops the value at the
top *
```



```

84 // of the stack off, and copies it into the
variable *
85 // passed as an argument.
*
86
//*****
*****
87
88 template <class T>
89 void DynamicStack<T>::pop(T &item)
90 {
91     StackNode *temp = nullptr; // Temporary
pointer
92
93     // First make sure the stack isn't empty.
94     if (isEmpty())
95     {
96         cout << "The stack is empty.\n";
97     }
98     else // pop value off top of stack
99     {
100         item = top->value;
101         temp = top->next;
102         delete top;
103         top = temp;
104     }
105 }

```



```
106
107
//*****
*****
108 // Member function isEmpty returns true if
the stack      *
109 // is empty, or false otherwise.
*
110
//*****
*****
111
112 template <class T>
113 bool DynamicStack<T>::isEmpty()
114 {
115     bool status;
116
117     if (!top)
118         status = true;
119     else
120         status = false;
121
122     return status;
123 }
124 #endif
```

**Program 19-5**  demonstrates the `DynamicStack` template. This program is a modification of **Program 19-3** . It creates a stack of strings then presents a menu that allows the user to push an item onto the stack, pop an item from the stack, or quit the program.

## Program 19-5

```
1  #include <iostream>
2  #include <string>
3  #include "DynamicStack.h"
4  using namespace std;
5
6  // Constants for the menu choices
7  const int PUSH_CHOICE = 1,
8           POP_CHOICE = 2,
9           QUIT_CHOICE = 3;
10
11 // Function prototypes
12 void menu(int &);
13 void getStackSize(int &);
14 void pushItem(DynamicStack<string> &);
15 void popItem(DynamicStack<string> &);
16
17 int main()
18 {
19     int choice; // To hold a menu choice
20
21     // Create the stack.
22     DynamicStack<string> stack;
23
```

```

24     do
25     {
26         // Get the user's menu choice.
27         menu(choice);
28
29         // Perform the user's choice.
30         if (choice != QUIT_CHOICE)
31         {
32             switch (choice)
33             {
34                 case PUSH_CHOICE:
35                     pushItem(stack);
36                     break;
37                 case POP_CHOICE:
38                     popItem(stack);
39             }
40         }
41     } while (choice != QUIT_CHOICE);
42
43     return 0;
44 }
45
46
47 //*****
48 // The menu function displays the menu and
49 gets *
50 // the user's choice, which is assigned to

```

```

the *
49 // reference parameter.
*
50
//*****
51 void menu(int &choice)
52 {
53     // Display the menu and get the user's
choice.
54     cout << "What do you want to do?\n"
55         << PUSH_CHOICE
56         << " - Push an item onto the
stack\n"
57         << POP_CHOICE
58         << " - Pop an item off the stack\n"
59         << QUIT_CHOICE
60         << " - Quit the program\n"
61         << "Enter your choice: ";
62     cin >> choice;
63
64     // Validate the choice
65     while (choice < PUSH_CHOICE || choice >
QUIT_CHOICE)
66     {
67         cout << "Enter a valid choice: ";
68         cin >> choice;
69     }

```

```

70 }
71
72
//*****
73 // The pushItem function gets an item from
the *
74 // user and pushes it onto the stack.
*
75
//*****
76 void pushItem(DynamicStack<string> &stack)
77 {
78     string item;
79
80     // Get an item to push onto the stack.
81     cin.ignore();
82     cout << "\nEnter an item: ";
83     getline(cin, item);
84     stack.push(item);
85 }
86
87
//*****
***
88 // The popItem function pops an item from the
stack *
89

```

```
/**
***
90 void popItem(DynamicStack<string> &stack)
91 {
92     string item = "";
93
94     // Pop the item.
95     stack.pop(item);
96
97     // Display the item.
98     if (item != "")
99         cout << item << " was popped.\n";
100 }
```

**Program Output with Example Input Shown in Bold**

What do you want to do?

- 1 - Push an item onto the stack
- 2 - Pop an item off the stack
- 3 - Quit the program

Enter your choice: **1** Enter

Enter an item: **The Catcher in the Rye** Enter

What do you want to do?

- 1 - Push an item onto the stack
- 2 - Pop an item off the stack
- 3 - Quit the program

Enter your choice: 1 Enter

Enter an item: **Crime and Punishment** Enter

What do you want to do?

- 1 - Push an item onto the stack
- 2 - Pop an item off the stack
- 3 - Quit the program

Enter your choice: **2** Enter

Crime and Punishment was popped.

What do you want to do?

- 1 - Push an item onto the stack
- 2 - Pop an item off the stack
- 3 - Quit the program

Enter your choice: **2** Enter



## 19.3 The STL `stack` Container

### Concept:

The Standard Template Library offers a `stack` template, which may be implemented as a `vector`, a `list`, or a `deque`.

So far, the STL containers you have learned about are `vector`s and `list`s. The STL `stack` container may be implemented as a `vector` or a `list`. (It may also be implemented as a `deque`, which you will learn about later in this chapter.) Because the `stack` container is used to adapt these other containers, it is often referred to as a *container adapter*.



Storing Objects in an STL `stack`

Here are examples of how to define a stack of `int`s, implemented as a `vector`, a `list`, and a `deque`:


```
stack<int, vector<int>> iStack; // Vector stack
stack<int, list<int>> iStack; // List stack
stack<int> iStack; // Default - deque stack
```



### Note:

If you are using a compiler that is older than C++ 11, be sure to put spaces between the angled brackets that appear next to each other. Older compilers will mistake the `>>` characters for the stream extraction operator, `>>`. Here is an example of how to write the definitions for an older compiler:

```
stack< int, vector<int> > iStack; // Vector stack
stack< int, list<int> > iStack; // List
stack
stack< int > iStack; //
Default - deque stack
```

**Table 19-3**  lists and describes some of the `stack` template's member functions.


11

### Table 19-3 Some of the `stack` Template Member Functions



#### Note:

The `pop` function in the `stack` template does not retrieve the value from the top of the stack, it only removes it. To retrieve the value, you must call the `top` function first.

**Program 19-6**  is a driver that demonstrates an STL `stack` implemented as a `vector`.

## Program 19-6

```
1 // This program demonstrates the STL stack
2 // container adapter.
3 #include <iostream>
4 #include <vector>
5 #include <stack>
6 using namespace std;
7
8 int main()
9 {
10     const int MAX = 8; // Max value to store
11     // in the stack
12     int count; // Loop counter
13
14     // Define an STL stack
15     stack< int, vector<int> > iStack;
16
17     // Push values onto the stack.
18     for (count = 2; count < MAX; count += 2)
19     {
20         cout << "Pushing " << count << endl;
21         iStack.push(count);
22     }
```

```
23     // Display the size of the stack.
24     cout << "The size of the stack is ";
25     cout << iStack.size() << endl;
26
27     // Pop the values off the stack.
28     for (count = 2; count < MAX; count += 2)
29     {
30         cout << "Popping " << iStack.top() <<
endl;
31         iStack.pop();
32     }
33     return 0;
34 }
```

## Program Output

```
Pushing 2
Pushing 4
Pushing 6
The size of the stack is 3
Popping 6
Popping 4
Popping 2
```



# Checkpoint

19.1 Describe what LIFO means.

19.2 What is the difference between static and dynamic stacks? What advantages do dynamic stacks have over static stacks?

19.3 What are the two primary stack operations? Describe them both.

19.4 What STL types does the STL stack container adapt?

## 19.4 Introduction to the Queue ADT

### Concept:

A queue is a data structure that stores and retrieves items in a `first-in, first-out` manner.

## Definition

Like a stack, a queue (pronounced “cue”) is a data structure that holds a sequence of elements. A queue, however, provides access to its elements in *first-in, first-out (FIFO)* order. The elements in a queue are processed like customers standing in a grocery checkout line: The first customer in line is the first one served.

## Application of Queues

Queue data structures are commonly used in computer operating systems. They are especially important in multiuser/multitasking environments where several users or tasks may be simultaneously requesting the same resource. Printing, for example, is controlled by a queue because only one document may be printed at a time. A queue is used to hold print jobs submitted by users of the system, while the printer services those jobs one at a time.

Communications software also uses queues to hold data received over networks. Sometimes data is transmitted to a system faster than it can be processed, so it is placed in a queue when it is received.

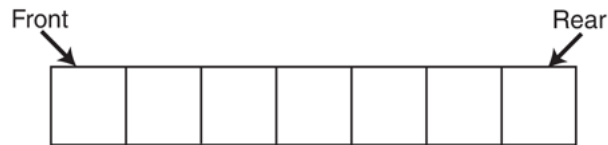
## Static and Dynamic Queues

Just as stacks are implemented as arrays or linked lists, so are queues. Dynamic queues offer the same advantages over static queues that dynamic stacks offer over static stacks. In fact, the primary difference between queues and stacks is the way data elements are accessed in each structure.

# Queue Operations

Just like checkout lines in a grocery store, think of queues as having a front and a rear. This is illustrated in [Figure 19-8](#).

**Figure 19-8** A queue has a front and a rear



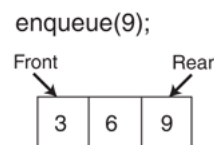
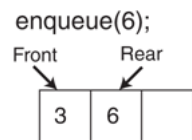
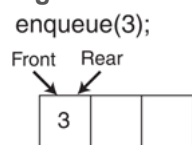
When an element is added to a queue, it is added to the rear. When an element is removed from a queue, it is removed from the front. The two primary queue operations are *enqueueing* and *dequeueing*. To enqueue means to insert an element at the rear of a queue, and to dequeue means to remove an element from the front of a queue. There are several different algorithms for implementing these operations. We will begin by looking at the most simple.

Suppose we have an empty static integer queue that is capable of holding a maximum of three values. With that queue, we execute the following enqueue operations:

```
enqueue (3) ;  
enqueue (6) ;  
enqueue (9) ;
```

[Figure 19-9](#) illustrates the state of the queue after each of these enqueue operations.

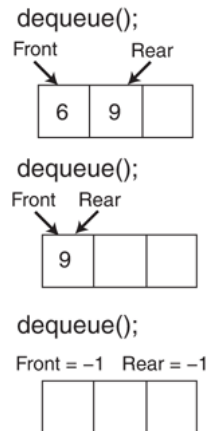
**Figure 19-9** State of the queue





Notice in this example the front index (which is a variable holding a subscript or perhaps a pointer) always references the same physical element. The rear index moves forward in the array as items are enqueued. Now, let's see how dequeue operations are performed. [Figure 19-10](#) illustrates the state of the queue after each of three consecutive dequeue operations.

**Figure 19-10 State of the queue**



In the dequeuing operation, the element at the front of the queue is removed. This is done by moving all the elements after it forward by one position. After the first dequeue operation, the value 3 is removed from the queue and the value 6 is at the front. After the second dequeue operation, the value 6 is removed and the value 9 is at the front. Notice when only one value is stored in the queue, that value is at both the front and the rear.

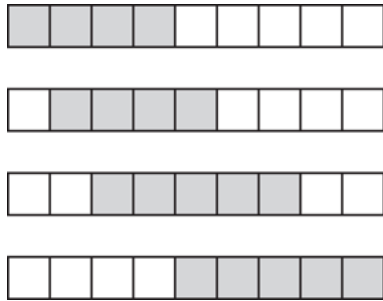
When the last dequeue operation is performed in [Figure 19-10](#), the queue is empty. An empty queue can be signified by setting both front and rear indices to -1.

The problem with this algorithm is its inefficiency. Each time an item is dequeued, the remaining items in the queue are copied forward to their neighboring elements. The more items there are in the queue, the longer each successive dequeue operation will take.

Here is one way to overcome the problem: Make both the front and rear indices move in the array. As before, when an item is enqueued, the rear index is moved to make room for it. But in this design, when an item is dequeued, the front index moves by one element toward the rear of the queue. This logically removes the front item from the queue, and eliminates the need to copy the remaining items to their neighboring elements.

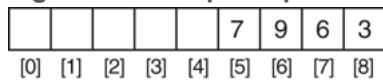
With this approach, as items are added and removed, the queue gradually “crawls” toward the end of the array. This is illustrated in [Figure 19-11](#). The shaded squares represent the queue elements (between the front and rear).

**Figure 19-11** The queue contents gradually crawl toward the end of the array



The problem with this approach is that the rear index cannot move beyond the last element in the array. The solution is to think of the array as circular instead of linear. When an item moves past the end of a circular array, it simply “wraps around” to the beginning. For example, consider the queue depicted in [Figure 19-12](#).

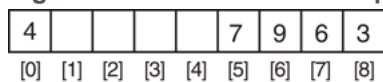
**Figure 19-12** A queue positioned at the end of an array



rear = 8  
front = 5

The value 3 is at the rear of the queue, and the value 7 is at the front of the queue. Now suppose an enqueue operation is performed, inserting the value 4 into the queue. [Figure 19-13](#) shows how the rear of the queue wraps around to the beginning of the array.

**Figure 19-13** The rear of the queue wraps around to the beginning



rear = 0  
front = 5

So, what is the code for wrapping the rear marker around to the opposite end of the array? One straightforward approach is to use an `if` statement such as

```
if (rear == queueSize - 1)
    rear = 0;
else
    rear++;
```

Another approach is with modular arithmetic:

```
rear = (rear + 1) % queueSize;
```

This statement uses the `%` operator to adjust the value in `rear` to the proper position. Although this approach appears more elegant, the choice of which code to use is yours.

## Detecting Full and Empty Queues with Circular Arrays

One problem with the circular array algorithm is that, because both the front and rear indices move through the array, detecting whether the queue is full or empty is a challenge. When the rear index and the front index reference the same element, does it indicate that only one item is in the queue, or that the queue is full? A number of approaches are commonly taken, two of which are listed below:

- When moving the rear index backward, always leave one element empty between it and the front index. The queue is full when the rear index is within two positions of the front index.
- Use a counter variable to keep a total of the number of items in the queue.

Because it might be helpful to keep a count of items in the queue anyway, we will use the second method in our implementation.

# A Static Queue Class

The declaration of the `IntQueue` class is as follows:

## Contents of `IntQueue.h`

```
1 // Specification file for the IntQueue class
2 #ifndef INTQUEUE_H
3 #define INTQUEUE_H
4
5 class IntQueue
6 {
7     private:
8         int *queueArray; // Points to the queue array
9         int queueSize;   // The queue size
10        int front;       // Subscript of the queue front
11        int rear;        // Subscript of the queue rear
12        int numItems;    // Number of items in the queue
13    public:
14        // Constructor
15        IntQueue(int);
16
17        // Copy constructor
18        IntQueue(const IntQueue &);
19
20        // Destructor
21        ~IntQueue();
22
23        // Queue operations
24        void enqueue(int);
25        void dequeue(int &);
26        bool isEmpty() const;
27        bool isFull() const;
28        void clear();
29 };
30 #endif
```

Notice in addition to the operations discussed in this section, the class also declares a member function named `clear`. This function clears the queue by resetting the `front` and `rear` indices and setting the `numItems` member to 0. The member function definitions are listed below.

## Contents of `IntQueue.cpp`

```
1 // Implementation file for the IntQueue class
2 #include <iostream>
3 #include "IntQueue.h"
4 using namespace std;
5
6 /*******
7 // This constructor creates an empty queue of a specified size. *
8 /*******
9
10 IntQueue::IntQueue(int s)
11 {
12     queueArray = new int[s];
13     queueSize = s;
14     front = -1;
15     rear = -1;
16     numItems = 0;
17 }
18
19 /*******
20 // Copy constructor *
21 /*******
22
23 IntQueue::IntQueue(const IntQueue &obj)
24 {
25     // Allocate the queue array.
26     queueArray = new int[obj.queueSize];
27
28     // Copy the other object's attributes.
29     queueSize = obj.queueSize;
30     front = obj.front;
31     rear = obj.rear;
32     numItems = obj.numItems;
33
34     // Copy the other object's queue array.
35     for (int count = 0; count < obj.queueSize; count++)
36         queueArray[count] = obj.queueArray[count];
37 }
```

```

38
39 //*****
40 // Destructor *
41 //*****
42
43 IntQueue::~IntQueue()
44 {
45     delete [] queueArray;
46 }
47
48 //*****
49 // Function enqueue inserts a value at the rear of the queue. *
50 //*****
51
52 void IntQueue::enqueue(int num)
53 {
54     if (isFull())
55         cout << "The queue is full.\n";
56     else
57     {
58         // Calculate the new rear position
59         rear = (rear + 1) % queueSize;
60         // Insert new item
61         queueArray[rear] = num;
62         // Update item count
63         numItems++;
64     }
65 }
66
67 //*****
68 // Function dequeue removes the value at the front of the queue *
69 // and copies t into num. *
70 //*****
71
72 void IntQueue::dequeue(int &num)
73 {
74     if (isEmpty())
75         cout << "The queue is empty.\n";
76     else
77     {
78         // Move front

```

```

79     front = (front + 1) % queueSize;
80     // Retrieve the front item
81     num = queueArray[front];
82     // Update item count
83     numItems--;
84 }
85 }
86
87 //*****
88 // isEmpty returns true if the queue is empty, otherwise false. *
89 //*****
90
91 bool IntQueue::isEmpty() const
92 {
93     bool status;
94
95     if (numItems)
96         status = false;
97     else
98         status = true;
99
100    return status;
101 }
102
103 //*****
104 // isFull returns true if the queue is full, otherwise false. *
105 //*****
106
107 bool IntQueue::isFull() const
108 {
109     bool status;
110
111     if (numItems < queueSize)
112         status = false;
113     else
114         status = true;
115
116    return status;
117 }
118
119 //*****

```



```
120 // clear sets the front and rear indices, and sets numItems to 0. *
121 /*******
122
123 void IntQueue::clear()
124 {
125     front = queueSize - 1;
126     rear = queueSize - 1;
127     numItems = 0;
128 }
```

**Program 19-7** is a driver that demonstrates the `IntQueue` class.

## Program 19-7

```
1 // This program demonstrates the IntQueue class.
2 #include <iostream>
3 #include "IntQueue.h"
4 using namespace std;
5
6 int main()
7 {
8     const int MAX_VALUES = 5; // Max number of values
9
10    // Create an IntQueue to hold the values.
11    IntQueue iQueue(MAX_VALUES);
12
13    // Enqueue a series of items.
14    cout << "Enqueuing " << MAX_VALUES << " items...\n";
15    for (int x = 0; x < MAX_VALUES; x++)
16        iQueue.enqueue(x);
17
18    // Attempt to enqueue just one more item.
19    cout << "Now attempting to enqueue again...\n";
20    iQueue.enqueue(MAX_VALUES);
21
22    // Dequeue and retrieve all items in the queue
23    cout << "The values in the queue were:\n";
24    while (!iQueue.isEmpty())
25    {
26        int value;
27        iQueue.dequeue(value);
28        cout << value << endl;
29    }
30    return 0;
31 }
```

## Program Output

```
Enqueuing 5 items...
Now attempting to enqueue again...
The queue is full.
The values in the queue were:
0
1
2
3
4
```

# A Static Queue Template

The queue class shown previously works only with integers. A queue template can be easily designed to work with any data type, as shown by the following example:

## Contents of `Queue.h`

```
1  #ifndef QUEUE_H
2  #define QUEUE_H
3  #include <iostream>
4  using namespace std;
5
6  // Stack template
7  template <class T>
8  class Queue
9  {
10 private:
11     T *queueArray;    // Points to the queue array
12     int queueSize;    // The queue size
13     int front;        // Subscript of the queue front
14     int rear;         // Subscript of the queue rear
15     int numItems;    // Number of items in the queue
16 public:
17     // Constructor
18     Queue(int);
19
20     // Copy constructor
21     Queue(const Queue &);
22
23     // Destructor
24     ~Queue();
25
26     // Queue operations
27     void enqueue(T);
28     void dequeue(T &);
29     bool isEmpty() const;
30     bool isFull() const;
31     void clear();
32 };
33
34 //*****
35 // This constructor creates an empty queue of a specified size. *
36 //*****
37 template <class T>
```

```

38 Queue<T>::Queue(int s)
39 {
40     queueArray = new T[s];
41     queueSize = s;
42     front = -1;
43     rear = -1;
44     numItems = 0;
45 }
46
47 //*****
48 // Copy constructor *
49 //*****
50 template <class T>
51 Queue<T>::Queue(const Queue &obj)
52 {
53     // Allocate the queue array.
54     queueArray = new T[obj.queueSize];
55
56     // Copy the other object's attributes.
57     queueSize = obj.queueSize;
58     front = obj.front;
59     rear = obj.rear;
60     numItems = obj.numItems;
61
62     // Copy the other object's queue array.
63     for (int count = 0; count < obj.queueSize; count++)
64         queueArray[count] = obj.queueArray[count];
65 }
66
67 //*****
68 // Destructor *
69 //*****
70 template <class T>
71 Queue<T>::~Queue()
72 {
73     delete [] queueArray;
74 }
75
76 //*****
77 // Function enqueue inserts a value at the rear of the queue. *
78 //*****

```

```

79  template <class T>
80  void Queue<T>::enqueue(T item)
81  {
82      if (isFull())
83          cout << "The queue is full.\n";
84      else
85          {
86              // Calculate the new rear position
87              rear = (rear + 1) % queueSize;
88              // Insert new item
89              queueArray[rear] = item;
90              // Update item count
91              numItems++;
92          }
93  }
94
95  //*****
96  // Function dequeue removes the value at the front of the queue *
97  // and copies t into num. *
98  //*****
99  template <class T>
100 void Queue<T>::dequeue(T &item)
101 {
102     if (isEmpty())
103         cout << "The queue is empty.\n";
104     else
105         {
106             // Move front
107             front = (front + 1) % queueSize;
108             // Retrieve the front item
109             item = queueArray[front];
110             // Update item count
111             numItems--;
112         }
113 }
114
115 //*****
116 // isEmpty returns true if the queue is empty, otherwise false.*
117 //*****
118 template <class T>
119 bool Queue<T>::isEmpty() const


```

```

120 {
121     bool status;
122
123     if (numItems)
124         status = false;
125     else
126         status = true;
127
128     return status;
129 }
130
131 //*****
132 // isFull returns true if the queue is full, otherwise false. *
133 //*****
134 template <class T>
135 bool Queue<T>::isFull() const
136 {
137     bool status;
138
139     if (numItems < queueSize)
140         status = false;
141     else
142         status = true;
143
144     return status;
145 }
146
147 //*****
148 // clear sets the front and rear indices, and sets numItems to 0. *
149 //*****
150 template <class T>
151 void Queue<T>::clear()
152 {
153     front = queueSize - 1;
154     rear = queueSize - 1;
155     numItems = 0;
156 }
157 #endif

```



**Program 19-8**  demonstrates the `Queue` template. It creates a queue that can hold strings, then prompts the user to enter a series of names that are enqueued. The program then dequeues all of the names and displays them.

## Program 19-8

```
1 // This program demonstrates the Queue template.
2 #include <iostream>
3 #include <string>
4 #include "Queue.h"
5 using namespace std;
6
7 const int QUEUE_SIZE = 5;
8
9 int main()
10 {
11     string name;
12
13     // Create a Queue.
14     Queue<string> queue(QUEUE_SIZE);
15
16     // Enqueue some names.
17     for (int count = 0; count < QUEUE_SIZE; count++)
18     {
19         cout << "Enter a name: ";
20         getline(cin, name);
21         queue.enqueue(name);
22     }
23
24     // Dequeue the names and display them.
25     cout << "\nHere are the names you entered:\n";
26     for (int count = 0; count < QUEUE_SIZE; count++)
27     {
28         queue.dequeue(name);
29         cout << name << endl;
30     }
31     return 0;
32 }
```

**Program Output with Example Input Shown in Bold**

Enter a name: **Chris** Enter

Enter a name: **Kathryn** Enter

Enter a name: **Alfredo** Enter

Enter a name: **Lori** Enter

Enter a name: **Kelly** Enter

Here are the names you entered:

Chris

Kathryn

Alfredo

Lori

Kelly

## 19.5 Dynamic Queues

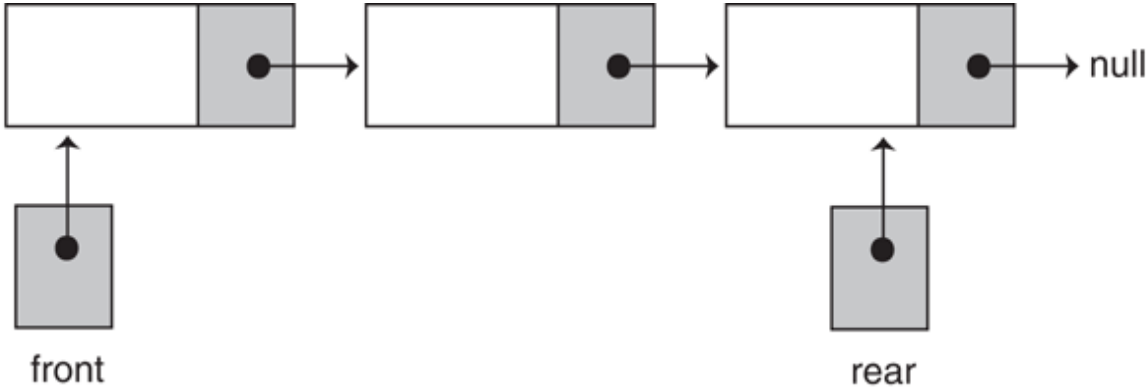
### Concept:

A queue may be implemented as a linked list and expand or shrink with each enqueue or dequeue operation.

Dynamic queues, which are built around linked lists, are much more intuitive to understand than static queues. A dynamic queue starts as an empty linked list. With the first enqueue operation, a node is added, which is pointed to by the `front` and `rear` pointers. As each new item is added to the queue, a new node is added to the rear of the list, and the `rear` pointer is updated to point to the new node. As each item is dequeued, the node pointed to by the `front` pointer is deleted, and `front` is made to point to the next node in the list.

**Figure 19-14**  shows the structure of a dynamic queue.

Figure 19-14 A dynamic queue



A dynamic integer queue class is listed here:

## Contents of `DynIntQueue.h`

```
1  #ifndef DYNINTQUEUE_H
2  #define DYNINTQUEUE_H
3
4  class DynIntQueue
5  {
6  private:
7      // Structure for the queue nodes
8      struct QueueNode
9      {
10         int value;          // Value in a node
11         QueueNode *next; // Pointer to the
next node
12     };
13
14     QueueNode *front; // The front of the
queue
15     QueueNode *rear;  // The rear of the queue
16     int numItems;     // Number of items in
the queue
17 public:
18     // Constructor
19     DynIntQueue();
20
```

```
21     // Destructor
22     ~DynIntQueue();
23
24     // Queue operations
25     void enqueue(int);
26     void dequeue(int &);
27     bool isEmpty() const;
28     bool isFull() const;
29     void clear();
30 };
31 #endif
```

## Contents of `DynIntQueue.cpp`

```
1  #include <iostream>
2  #include "DynIntQueue.h"
3  using namespace std;
4
5
6  //*****
7  // The constructor creates an empty queue. *
8
9  //*****
10
11 DynIntQueue::DynIntQueue ()
12 {
13     front = nullptr;
14     rear = nullptr;
15     numItems = 0;
16 }
17
18 //*****
19 // Destructor *
```



```

20  DynIntQueue::~DynIntQueue ()
21  {
22      clear();
23  }
24
25
26  //*****
27  // Function enqueue inserts the value in num
28  // at the rear of the queue. *
29  //*****
30  void DynIntQueue::enqueue(int num)
31  {
32      QueueNode *newNode = nullptr;
33
34      // Create a new node and store num there.
35      newNode = new QueueNode;
36      newNode->value = num;
37      newNode->next = nullptr;
38
39      // Adjust front and rear as necessary.
40      if (isEmpty())
41      {
42          front = newNode;
43          rear = newNode;

```


```

44     }
45     else
46     {
47         rear->next = newNode;
48         rear = newNode;
49     }
50
51     // Update numItems.
52     numItems++;
53 }
54
55
56 //*****
57 // Function dequeue removes the value at the
58 *
59 // front of the queue, and copies it into
60 num. *
61 //*****
62 void DynIntQueue::dequeue(int &num)
63 {
64     QueueNode *temp = nullptr;
65
66     if (isEmpty())
67     {
68         cout << "The queue is empty.\n";

```

```
67     }
68     else
69     {
70         // Save the front node value in num.
71         num = front->value;
72
73         // Remove the front node and delete
it.
74         temp = front;
75         front = front->next;
76         delete temp;
77
78         // Update numItems.
79         numItems--;
80     }
81 }
82
83
//*****
84 // Function isEmpty returns true if the queue
*
85 // is empty, and false otherwise.
*
86
//*****
87
88 bool DynIntQueue::isEmpty() const
```

```
89 {
90     bool status;
91
92     if (numItems > 0)
93         status = false;
94     else
95         status = true;
96     return status;
97 }
98
99
//*****
100 // Function clear dequeues all the elements *
101 // in the queue. *
102
//*****
103
104 void DynIntQueue::clear()
105 {
106     int value; // Dummy variable for dequeue
107
108     while(!isEmpty())
109         dequeue(value);
110 }
```

**Program 19-9**  is a driver that demonstrates the `DynIntQueue` class.

## Program 19-9

```
1 // This program demonstrates the DynIntQueue
class.
2 #include <iostream>
3 #include "DynIntQueue.h"
4 using namespace std;
5
6 int main()
7 {
8     const int MAX_VALUES = 5;
9
10    // Create a DynIntQueue object.
11    DynIntQueue iQueue;
12
13    // Enqueue a series of numbers.
14    cout << "Enqueuing " << MAX_VALUES << "
items...\n";
15    for (int x = 0; x < 5; x++)
16        iQueue.enqueue(x);
17
18    // Dequeue and retrieve all numbers in the
queue
19    cout << "The values in the queue were:\n";
20    while (!iQueue.isEmpty())
```

```
21     {  
22         int value;  
23         iQueue.dequeue(value);  
24         cout << value << endl;  
25     }  
26     return 0;  
27 }
```

## Program Output

```
Enqueuing 5 items...  
The values in the queue were:  
0  
1  
2  
3  
4
```

# A Dynamic Queue Template

The dynamic queue class shown previously in this chapter works only with integers. A dynamic queue template can be easily designed to work with any data type, as shown by the following example:



## Contents of `DynamicQueue.h`

```
1  #ifndef DYNAMICQUEUE_H
2  #define DYNAMICQUEUE_H
3  #include <iostream>
4  using namespace std;
5
6  // DynamicQueue template
7  template <class T>
8  class DynamicQueue
9  {
10 private:
11     // Structure for the queue nodes
12     struct QueueNode
13     {
14         T value;           // Value in a
node
15         QueueNode *next;  // Pointer to the
next node
16     };
17
18     QueueNode *front;    // The front of the
queue
19     QueueNode *rear;    // The rear of the
queue
```

```

20     int numItems;          // Number of items in
the queue
21     public:
22         // Constructor
23         DynamicQueue();
24
25         // Destructor
26         ~DynamicQueue();
27
28         // Queue operations
29         void enqueue(T);
30         void dequeue(T &);
31         bool isEmpty() const;
32         bool isFull() const;
33         void clear();
34     };
35
36
//*****
37 // The constructor creates an empty queue.  *
38
//*****
39     template <class T>
40     DynamicQueue<T>::DynamicQueue()
41     {
42         front = nullptr;
43         rear = nullptr;

```

```

44     numItems = 0;
45 }
46
47
//*****
48 // Destructor *
49
//*****
50 template <class T>
51 DynamicQueue<T>::~DynamicQueue()
52 {
53     clear();
54 }
55
56
//*****
57 // Function enqueue inserts the value in num
*
58 // at the rear of the queue. *
59
//*****
60 template <class T>
61 void DynamicQueue<T>::enqueue(T item)
62 {
63     QueueNode *newNode = nullptr;
64
65     // Create a new node and store num there.

```

```

66     newNode = new QueueNode;
67     newNode->value = item;
68     newNode->next = nullptr;
69
70     // Adjust front and rear as necessary.
71     if (isEmpty())
72     {
73         front = newNode;
74         rear = newNode;
75     }
76     else
77     {
78         rear->next = newNode;
79         rear = newNode;
80     }
81
82     // Update numItems.
83     numItems++;
84 }
85
86
//*****
87 // Function dequeue removes the value at the
*
88 // front of the queue, and copies it into
num. *
89

```

```

90  template <class T>
91  void DynamicQueue<T>::dequeue(T &item)
92  {
93      QueueNode *temp = nullptr;
94
95      if (isEmpty())
96      {
97          cout << "The queue is empty.\n";
98      }
99      else
100     {
101         // Save the front node value in num.
102         item = front->value;
103
104         // Remove the front node and delete
105         it.
106         temp = front;
107         front = front->next;
108         delete temp;
109
110         // Update numItems.
111         numItems--;
112     }
113
114




```

```

/*****
115 // Function isEmpty returns true if the queue
*
116 // is empty, and false otherwise.
*
117
/*****
118 template <class T>
119 bool DynamicQueue<T>::isEmpty() const
120 {
121     bool status;
122
123     if (numItems > 0)
124         status = false;
125     else
126         status = true;
127     return status;
128 }
129
130
/*****
131 // Function clear dequeues all the elements *
132 // in the queue. *
133
/*****
134 template <class T>
135 void DynamicQueue<T>::clear()

```

```
136 {
137     T value; // Dummy variable for dequeue
138
139     while (!isEmpty())
140         dequeue(value);
141 }
142 #endif
```

**Program 19-10**  demonstrates the `DynamicQueue` template. This program is a modification of **Program 19-8** . It creates a queue that can hold strings then prompts the user to enter a series of names that are enqueued. The program then dequeues all of the names and displays them. (The program's output is the same as that of **Program 19-8** .)

## Program 19-10

```
1 // This program demonstrates the DynamicQueue
template.
2 #include <iostream>
3 #include <string>
4 #include "DynamicQueue.h"
5 using namespace std;
6
7 const int QUEUE_SIZE = 5;
8
9 int main()
10 {
11     string name;
12
13     // Create a Queue.
14     DynamicQueue<string> queue;
15
16     // Enqueue some names.
17     for (int count = 0; count < QUEUE_SIZE;
count++)
18     {
19         cout << "Enter a name: ";
20         getline(cin, name);
21         queue.enqueue(name);
```



```
22     }  
23  
24     // Dequeue the names and display them.  
25     cout << "\nHere are the names you  
entered:\n";  
26     for (int count = 0; count < QUEUE_SIZE;  
count++)  
27     {  
28         queue.dequeue(name);  
29         cout << name << endl;  
30     }  
31     return 0;  
32 }
```

## Program Output

(Same as [Program 19-8](#)'s output.)

## 19.6 The STL `deque` and `queue` Containers

### Concept:

The Standard Template Library provides two containers, `deque` and `queue`, for implementing queue-like data structures.

In this section, we will examine two ADTs offered by the Standard Template Library: `deque` and `queue`. A `deque` (pronounced “deck” or “deek”) is a double-ended queue. It is similar to a `vector`, but allows efficient access to values at both the front and the rear. The `queue` ADT is a container adapter that uses a `deque` as its default container.

# The `deque` Container

Think of the `deque` container as a `vector` that provides quick access to the element at its front as well as at the back. (Like `vector`, `deque` also provides access to its elements with the `[]` operator.)

Programs that use the `deque` ADT must include the `deque` header. Because we are concentrating on its queue-like characteristics, we will focus our attention on the `push_back`, `pop_front`, and `front` member functions. [Table 19-4](#) describes them.

## Table 19-4 Some of the `deque` Template Member Functions

[Program 19-11](#) demonstrates the `deque` container.

## Program 19-11

```
1 // This program demonstrates the STL deque
  container.
2 #include <iostream>
3 #include <deque>
4 using namespace std;
5
6 int main()
7 {
8     const int MAX = 8; // Max value
9     int count;        // Loop counter
10
11     // Create a deque object.
12     deque<int> iDeque;
13
14     // Enqueue a series of numbers.
15     cout << "I will now enqueue items...\n";
16     for (count = 2; count < MAX; count += 2)
17     {
18         cout << "Pushing " << count << endl;
19         iDeque.push_back(count);
20     }
21
22     // Dequeue and display the numbers.
```

```
23     cout << "I will now dequeue items...\n";
24     for (count = 2; count < MAX; count += 2)
25     {
26         cout << "Popping " << iDeque.front() <<
endl;
27         iDeque.pop_front();
28     }
29     return 0;
30 }
```

## Program Output

```
I will now enqueue items...
Pushing 2
Pushing 4
Pushing 6
I will now dequeue items...
Popping 2
Popping 4
Popping 6
```

# The `queue` Container Adapter

The `queue` container adapter can be built upon `vectors`, `lists`, or `deque`s. By default, it uses `deque` as its base.



## Storing Objects in an STL `queue`

The insertion and removal operations supported by `queue` are the same as those supported by the `stack` ADT: `push`, `pop`, and `front`. There are differences in their behavior, however. The `queue` version of `push` always inserts an element at the rear of the `queue`. The `queue` version of `pop` always removes an element from the structure's front. The `front` function returns the value of the element at the front of the `queue`.

**Program 19-12** [📄](#) demonstrates a `queue`. Because the definition of the `queue` does not specify which type of container is being adapted, the `queue` will be built on a `deque`.

## Program 19-12

```
1 // This program demonstrates the STL queue
  container adapter.
2 #include <iostream>
3 #include <queue>
4 using namespace std;
5
6 int main()
7 {
8     const int MAX = 8; // Max value
9     int count;        // Loop counter
10
11     // Define a queue object.
12     queue<int> iQueue;
13
14     // Enqueue a series of numbers.
15     cout << "I will now enqueue items...\n";
16     for (count = 2; count < MAX; count += 2)
17     {
18         cout << "Pushing " << count << endl;
19         iQueue.push(count);
20     }
21
22     // Dequeue and display the numbers.
```

```
23     cout << "I will now dequeue items...\n";
24     for (count = 2; count < MAX; count += 2)
25     {
26         cout << "Popping "<< iQueue.front() <<
endl;
27         iQueue.pop();
28     }
29     return 0;
30 }
```

## Program Output

```
I will now enqueue items...
Pushing 2
Pushing 4
Pushing 6
I will now dequeue items...
Popping 2
Popping 4
Popping 6
```



# Review Questions and Exercises

## Short Answer

1. What does LIFO mean?
2. What element is always retrieved from a stack?
3. What is the difference between a static stack and a dynamic stack?
4. Describe two operations that all stacks perform.
5. Describe two operations that static stacks must perform.
6. The STL `stack` is considered a container adapter. What does that mean?
7. What types may the STL `stack` be based on? By default, what type is an STL `stack` based on?
8. What does FIFO mean?
9. When an element is added to a queue, where is it added?
10. When an element is removed from a queue, where is it removed from?
11. Describe two operations that all queues perform.
12. What two queue-like containers does the STL offer?

# Fill-in-the-Blank

13. The \_\_\_\_\_ element saved onto a stack is the first one retrieved.
14. The two primary stack operations are \_\_\_\_\_ and \_\_\_\_\_.
15. \_\_\_\_\_ stacks and queues are implemented as arrays.
16. \_\_\_\_\_ stacks and queues are implemented as linked lists.
17. The STL stack container is an adapter for the \_\_\_\_\_, \_\_\_\_\_, and \_\_\_\_\_ STL containers.
18. The \_\_\_\_\_ element saved in a queue is the first one retrieved.
19. The two primary queue operations are \_\_\_\_\_ and \_\_\_\_\_.
20. The two ADTs in the Standard Template Library that exhibit queue-like behavior are \_\_\_\_\_ and \_\_\_\_\_.
21. The queue ADT, by default, adapts the \_\_\_\_\_ container.

# Algorithm Workbench

22. Suppose the following operations are performed on an empty stack:

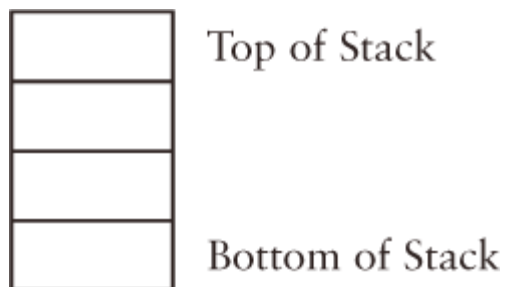
```
push(0);
```

```
push(9);
```

```
push(12);
```

```
push(1);
```

Insert numbers in the following diagram to show what will be stored in the static stack after the operations above have executed.



23. Suppose the following operations are performed on an empty stack:

```
push(8);
```

```
push(7);
```

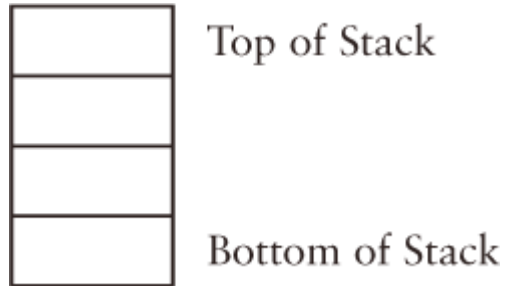
```
pop();
```

```
push(19);
```

```
push(21);
```

```
pop();
```

Insert numbers in the following diagram to show what will be stored in the static stack after the operations above have executed.



24. Suppose the following operations are performed on an empty queue:

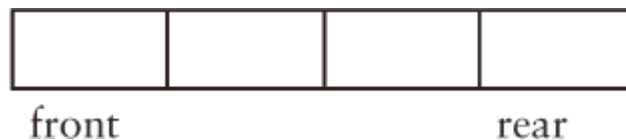
```
enqueue (5) ;
```

```
enqueue (7) ;
```

```
enqueue (9) ;
```

```
enqueue (12) ;
```

Insert numbers in the following diagram to show what will be stored in the static queue after the operations above have executed.



25. Suppose the following operations are performed on an empty queue:

```
enqueue (5) ;
```

```
enqueue (7) ;
```

```
dequeue () ;
```

```
enqueue (9) ;
```

```
enqueue (12) ;
```

```
dequeue();
```

```
enqueue(10);
```

Insert numbers in the following diagram to show what will be stored in the static queue after the operations above have executed.



26. What problem is overcome by using a circular array for a static queue?
27. Write two different code segments that may be used to wrap an index back around to the beginning of an array when it moves past the end of the array. Use an `if/else` statement in one segment, and modular arithmetic in the other.

## True or False

28. T F A static stack or queue is built around an array.
29. T F The size of a dynamic stack or queue must be known in advance.
30. T F The push operation inserts an element at the end of a stack.
31. T F The pop operation retrieves an element from the top of a stack.
32. T F The STL stack container's pop operation does not retrieve the top element of the stack, it just removes it.

# Programming Challenges

## 1. Static Stack Template

Write your own version of a class template that will create a static stack of any data type. Demonstrate the class with a driver program.

## 2. Dynamic Stack Template

Write your own version of a class template that will create a dynamic stack of any data type. Demonstrate the class with a driver program.

## 3. Static Queue Template

Write your own version of a class template that will create a static queue of any data type. Demonstrate the class with a driver program.

## 4. Dynamic Queue Template

Write your own version of a class template that will create a dynamic queue of any data type. Demonstrate the class with a driver program.

## 5. Error Testing

The `DynIntStack` and `DynIntQueue` classes shown in this chapter are abstract data types using a dynamic stack and dynamic queue, respectively. The classes do not currently test for memory allocation errors. Modify the classes so they determine whether new nodes cannot be created by handling the `bad_alloc` exception.



## Note:

If you have already done Programming Challenges 2 and 4, modify the templates you created.

### 6. Dynamic String Stack

Design a class that stores strings on a dynamic stack. The strings should not be fixed in length. Demonstrate the class with a driver program.

### 7. Dynamic MathStack

The `MathStack` class shown in this chapter has only two member functions: `add` and `sub`. Write the following additional member functions:

Demonstrate the class with a driver program.

### 8. Dynamic MathStack Template

Currently, the `MathStack` class is derived from the `IntStack` class. Modify it so it is a template, derived from the template you created in Programming Challenge 2 (Dynamic Stack Template).

### 9. File Reverser

Write a program that opens a text file and reads its contents into a stack of characters. The program should then pop the characters from the stack and save them in a second text file. The order of the characters saved in the second file should be the reverse of their order in the first file.

### 10. File Filter

Write a program that opens a text file and reads its contents into a queue of characters. The program should then dequeue each character, convert it to uppercase, and store it in a second file.

## 11. File Compare



### Solving the File Compare Problem

Write a program that opens two text files and reads their contents into two separate queues. The program should then determine whether the files are identical by comparing the characters in the queues. When two nonidentical characters are encountered, the program should display a message indicating that the files are not the same. If both queues contain the same set of characters, a message should be displayed indicating that the files are identical.

## 12. Inventory Bin Stack

Design an inventory class that stores the following members: The class should have appropriate member functions for storing data into, and retrieving data from, these members.



Next, design a stack class that can hold objects of the class described above. If you wish, you may use the template you designed in Programming Challenge 1 or 2.

Last, design a program that uses the stack class described above. The program should have a loop that asks the user if he or she wishes to add a part to inventory, or take a part from inventory. The loop should repeat until the user is finished.

If the user wishes to add a part to inventory, the program should ask for the serial number, date of manufacture, and lot number. The data should be stored in an inventory object, and pushed onto the stack.

If the user wishes to take a part from inventory, the program should pop the top-most part from the stack and display the contents of its member variables.

When the user finishes the program, it should display the contents of the member values of all the objects that remain on the stack.

### **13. Inventory Bin Queue**

Modify the program you wrote for Programming Challenge 12 (Inventory Bin Stack) so it uses a queue instead of a stack.

Compare the order in which the parts are removed from the bin for each program.

### **14. Balanced Parentheses**

A string of characters has balanced parentheses if each right parenthesis occurring in the string is matched with a preceding left parenthesis, in the same way that each right brace in a C++ program is matched with a preceding left brace. Write a program that uses a stack to determine

whether a string entered at the keyboard has balanced parentheses.

### 15. **Balanced Multiple Delimiters**

A string may use more than one type of delimiter to bracket information into “blocks.” For example, a string may use braces { }, parentheses ( ), and brackets [ ] as delimiters. A string is properly delimited if each right delimiter is matched with a preceding left delimiter of the same type in such a way that either the resulting blocks of information are disjoint, or one of them is completely nested within the other. Write a program that uses a single stack to check whether a string containing braces, parentheses, and brackets is properly delimited.

---

# Chapter 20 Recursion


---


## Topics

**20.1 Introduction to Recursion** 

**20.2 Solving Problems with Recursion** 

**20.3 Focus on Problem Solving and Program Design: The Recursive gcd Function** 

**20.4 Focus on Problem Solving and Program Design: Solving Recursively Defined Problems** 

**20.5 Focus on Problem Solving and Program Design: Recursive Linked List Operations** 

**20.6 Focus on Problem Solving and Program Design: A Recursive Binary Search Function** 

**20.7 The Towers of Hanoi** 

**20.8 Focus on Problem Solving and Program Design: The QuickSort Algorithm** 

**20.9 Exhaustive Algorithms** 

**20.10 Focus on Software Engineering: Recursion versus Iteration** 

## 20.1 Introduction to Recursion

### Concept:

A recursive function is one that calls itself.

You have seen instances of functions calling other functions. Function A can call function B, which can then call function C. It's also possible for a function to call itself. A function that calls itself is a *recursive function*. Look at this `message` function:

```
void message ()
{
    cout << "This is a recursive function.\n";
    message ();
}
```

This function displays the string “This is a recursive function.\n”, then calls itself. Each time it calls itself, the cycle is repeated. Can you see a problem with the function? There's no way to stop the recursive calls. This function is like an infinite loop because there is no code to stop it from repeating.



### Note:

The function example `message` will eventually cause the program to crash. Do you remember learning in [Chapter 19](#) that the system stores temporary data on a stack each time a function is called? Eventually, these recursive function calls will use up all available stack memory and cause it to overflow.

Like a loop, a recursive function must have some method to control the number of times it repeats. The following is a modification of the `message` function. It passes an integer argument that holds the number of times the function is to call itself.

```

void message(int times)
{
    if (times > 0)
    {
        cout << "This is a recursive function.\n";
        message(times - 1);
    }
}

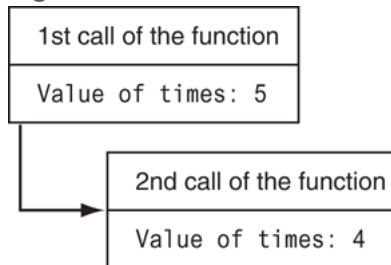
```

This function contains an `if` statement that controls the repetition. As long as the `times` argument is greater than zero, it will display the message and call itself again. Each time it calls itself, it passes `times - 1` as the argument. For example, let's say a program calls the function with the following statement:

```
message(5);
```

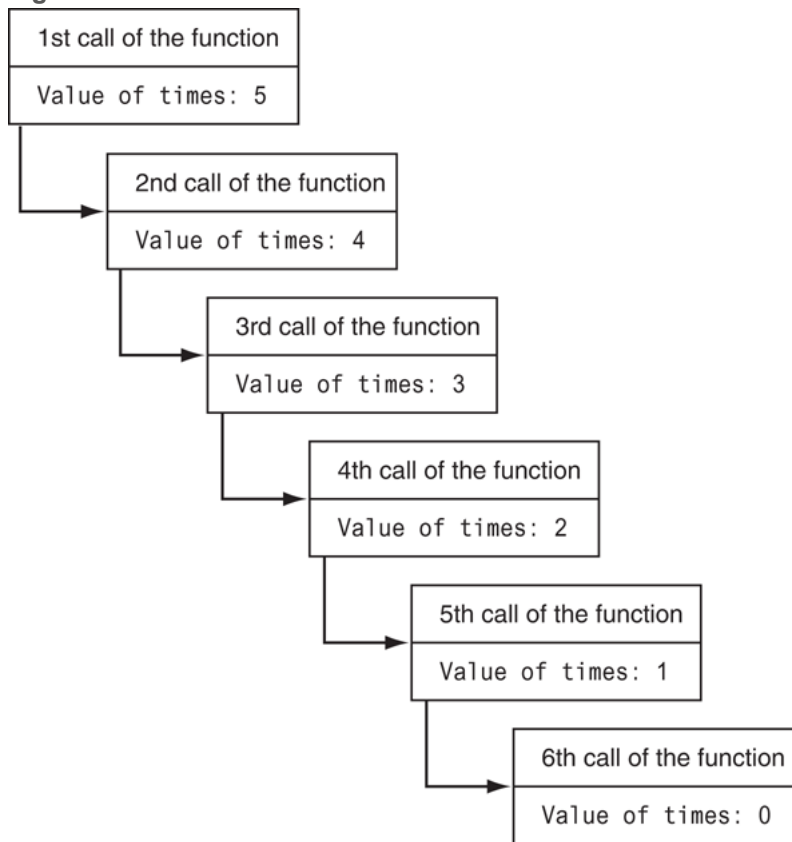
The argument, 5, will cause the function to call itself five times. The first time the function is called, the `if` statement will display the message then call itself with 4 as the argument. [Figure 20-1](#) illustrates this.

**Figure 20-1 Recursive function call**



The diagram in [Figure 20-1](#) illustrates two separate calls of the `message` function. Each time the function is called, a new instance of the `times` parameter is created in memory. The first time the function is called, the `times` parameter is set to 5. When the function calls itself, a new instance of `times` is created, and the value 4 is passed into it. This cycle repeats until, finally, zero is passed to the function. This is illustrated in [Figure 20-2](#).

Figure 20-2 Recursive function calls



As you can see from [Figure 20-2](#), the function is called a total of six times. The first time it is called from `main`, and the other five times it calls itself, so the *depth of recursion* is five. When the function reaches its sixth call, the `times` parameter will be set to 0. At that point, the `if` statement's conditional expression will be false, so the function will return. Control of the program will return from the sixth instance of the function to the point in the fifth instance directly after the recursive function call:

```
void message (int times)
{
    if (times > 0
        {
            cout << "This is a recursive function.\n"
            message (times - 1); ← Recursive call
        }
    } ← Control returns here from the recursive call,
    causing the function to return.
```

Because there are no more statements to be executed after the function call, the fifth instance of the function returns control of the program back to the fourth instance. This repeats until all instances of the function return. [Program 20-1](#) demonstrates the recursive `message` function.

## Program 20-1

```
1 // This program demonstrates a simple recursive function.
2 #include <iostream>
3 using namespace std;
4
5 // Function prototype
6 void message(int);
7
8 int main()
9 {
10     message(5);
11     return 0;
12 }
13
14 //*****
15 // Definition of function message. If the value in times is *
16 // greater than 0, the message is displayed and the *
17 // function is recursively called with the argument *
18 // times - 1. *
19 //*****
20
21 void message(int times)
22 {
23     if (times > 0)
24     {
25         cout << "This is a recursive function.\n";
26         message(times - 1);
27     }
28 }
```

## Program Output



```
This is a recursive function.  
This is a recursive function.  
This is a recursive function.  
This is a recursive function.  
This is a recursive function.
```

To further illustrate the inner workings of this recursive function, let's look at another version of the program. In [Program 20-2](#), a message is displayed each time the function is entered, and another message is displayed just before the function returns.

## Program 20-2

```
1 // This program demonstrates a simple recursive function.
2 #include <iostream>
3 using namespace std;
4
5 // Function prototype
6 void message(int);
7
8 int main()
9 {
10     message(5);
11     return 0;
12 }
13
14 //*****
15 // Definition of function message. If the value in times is *
16 // greater than 0, the message is displayed and the function *
17 // is recursively called with the argument times - 1. *
18 //*****
19
20 void message(int times)
21 {
22     cout << "message called with " << times << " in times.\n";
23
24     if (times > 0)
25     {
26         cout << "This is a recursive function.\n";
27         message(times - 1);
28     }
29
30     cout << "message returning with " << times;
31     cout << " in times.\n";
32 }
```

## Program Output

```
message called with 5 in times.  
This is a recursive function.  
message called with 4 in times.  
This is a recursive function.  
message called with 3 in times.  
This is a recursive function.  
message called with 2 in times.  
This is a recursive function.  
message called with 1 in times.  
This is a recursive function.  
message called with 0 in times.  
message returning with 0 in times.  
message returning with 1 in times.  
message returning with 2 in times.  
message returning with 3 in times.  
message returning with 4 in times.  
message returning with 5 in times.
```

## 20.2 Solving Problems with Recursion

### Concept:

A problem can be solved with recursion if it can be broken down into successive smaller problems that are identical to the overall problem.

[Programs 20-1](#) and [20-2](#) in the previous section show simple demonstrations of *how* a recursive function works. But these examples don't show us *why* we would want to write a recursive function. Recursion can be a powerful tool for solving repetitive problems and is an important topic in upper-level computer science courses. What might not be clear to you yet is how to use recursion to solve a problem.

First, it should be noted that recursion is never absolutely required to solve a problem. Any problem that can be solved recursively can also be solved iteratively, with a loop. In fact, recursive algorithms are usually less efficient than iterative algorithms. This is because a function call requires several actions to be performed by the C++ runtime system. These actions include allocating memory for parameters and local variables and storing the address of the program location where control returns after the function terminates. These actions, which are sometimes referred to as *overhead*, take place with each function call. Such overhead is not necessary with a loop.

Some repetitive problems, however, are more easily solved with recursion than with iteration. Where an iterative algorithm might result in faster execution time, the programmer might be able to design a recursive algorithm faster.

In general, a recursive function works like this:

- If the problem can be solved now, without recursion, then the function solves it and returns.
- If the problem cannot be solved now, then the function reduces it to a smaller but similar problem and calls itself to solve the smaller problem.



## Reducing a Problem with Recursion

In order to apply this approach, we first identify at least one case in which the problem can be solved without recursion. This is known as the *base case*. Second, we determine a way to solve the problem in all other circumstances using recursion. This is called the *recursive case*. In the recursive case, we must always reduce the problem to a smaller version of the original problem. By reducing the problem with each recursive call, the base case will eventually be reached, and the recursion will stop.

# Example: Using Recursion to Calculate the Factorial of a Number

Let's take an example from mathematics to examine an application of recursion. In mathematics, the notation  $n!$  represents the factorial of the number  $n$ . The factorial of a nonnegative number can be defined by the following rules:

If  $n = 0$  then  $n! = 1$

If  $n > 0$  then  $n! = 1 \times 2 \times 3 \times \dots \times n$

Let's replace the notation  $n!$  with  $\text{factorial}(n)$ , which looks a bit more like computer code, and rewrite these rules as

If  $n = 0$  then  $\text{factorial}(n) = 1$

If  $n > 0$  then  $\text{factorial}(n) = 1 \times 2 \times 3 \times \dots \times n$

These rules state that when  $n$  is 0, its factorial is 1. When  $n$  is greater than 0, its factorial is the product of all the positive integers from 1 up to  $n$ . For instance,  $\text{factorial}(6)$  is calculated as  $1 \times 2 \times 3 \times 4 \times 5 \times 6$ .

When designing a recursive algorithm to calculate the factorial of any number, we first identify the base case, which is the part of the calculation we can solve without recursion. That is the case where  $n$  is equal to 0.

If  $n = 0$  then  $\text{factorial}(n) = 1$

This tells us how to solve the problem when  $n$  is equal to 0, but what do we do when  $n$  is greater than 0? That is the recursive case, or the part of the problem we use recursion to solve. This is how we express it:

If  $n > 0$  then  $\text{factorial}(n) = n \times \text{factorial}(n - 1)$

This states if  $n$  is greater than 0, the factorial of  $n$  is  $n$  times the factorial of  $n - 1$ . Notice how the recursive call works on a reduced version of the problem,  $n - 1$ . So, our recursive rule for calculating the factorial of a number might look like this:

If  $n = 0$  then  $\text{factorial}(n) = 1$


If  $n > 0$  then  $\text{factorial}(n) = n \times \text{factorial}(n - 1)$

The following pseudocode shows how we might implement the factorial algorithm as a recursive function:

```
factorial(n)
  If n is 0 then
    return 1
  else
    return n times the factorial of n - 1
end factorial
```

Here is the C++ code for such a function:

```
int factorial(int n)
{
  if (n == 0)
    return 1; // Base case
  else
    return n * factorial(n - 1); // Recursive case
}
```

**Program 20-3**  demonstrates the recursive factorial function.

## Program 20-3

```
1 // This program demonstrates a recursive function to
2 // calculate the factorial of a number.
3 #include <iostream>
4 using namespace std;
5
6 // Function prototype
7 int factorial(int);
8
9 int main()
10 {
11     int number;
12
13     // Get a number from the user.
14     cout << "Enter an integer value and I will display\n";
15     cout << "its factorial: ";
16     cin >> number;
17
18     // Display the factorial of the number.
19     cout << "The factorial of " << number << " is ";
20     cout << factorial(number) << endl;
21     return 0;
22 }
23
24 /*******
25 // Definition of factorial. A recursive function to calculate *
26 // the factorial of the parameter n. *
27 /*******
28
29 int factorial(int n)
30 {
31     if (n == 0)
32         return 1; // Base case
33     else
34         return n * factorial(n - 1); // Recursive case
35 }
```



## Program Output with Example Input Shown in Bold

```
Enter an integer value and I will display  
its factorial: 4 Enter  
The factorial of 4 is 24
```

In the example run of the program, the `factorial` function is called with the argument 4 passed into `n`. Because `n` is not equal to 0, the `if` statement's `else` clause executes the following statement, in line 34:

```
return n * factorial(n - 1);
```

Although this is a `return` statement, it does not immediately return. Before the return value can be determined, the value of `factorial(num - 1)` must be determined. The `factorial` function is called recursively until the fifth call, in which the `n` parameter will be set to zero. The diagram in [Figure 20-3](#) illustrates the value of `n` and the return value during each call of the function.

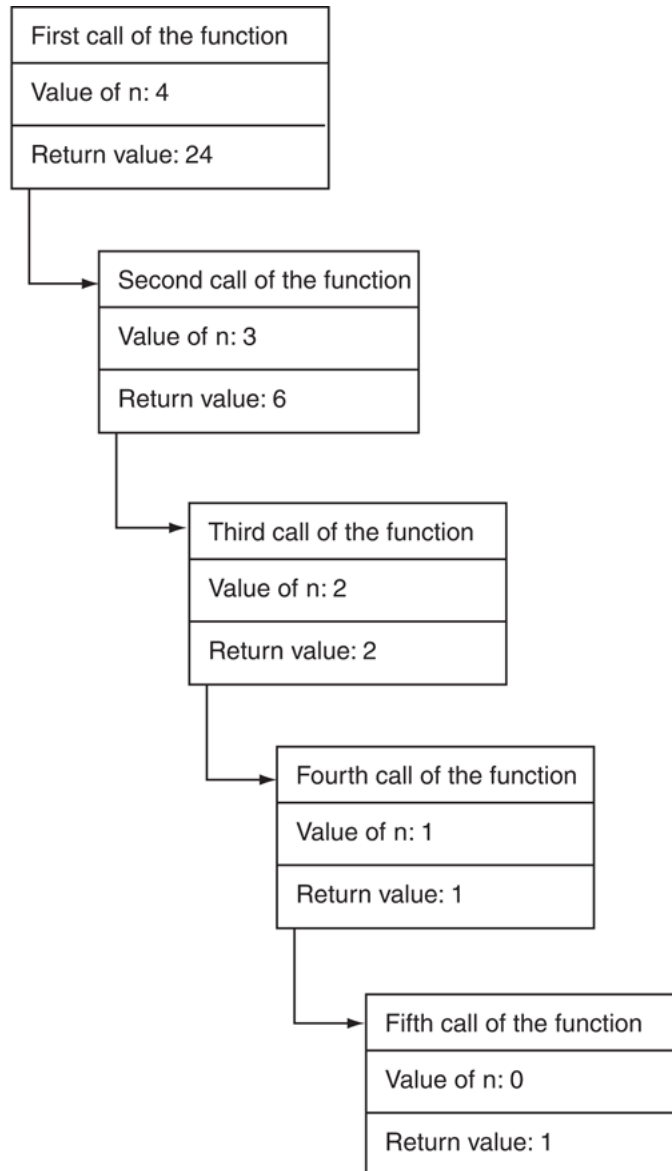
This diagram illustrates why a recursive algorithm must reduce the problem with each recursive call. Eventually the recursion has to stop in order for a solution to be reached. If each recursive call works on a smaller version of the problem, then the recursive calls work toward the base case. The base case does not require recursion, so it stops the chain of recursive calls.

Usually, a problem is reduced by making the value of one or more parameters smaller with each recursive call. In our `factorial` function, the value of the parameter `n` gets closer to 0 with each recursive call. When the parameter reaches 0, the function returns a value without making another recursive call.

### Figure 20-3 Recursive function calls

The function is first called from the main function. →

The second through fifth calls are recursive.



# Example: Using Recursion to Count Characters

Let's look at another simple example of recursion. The following function counts the number of times a specific character appears in a string. The line numbers are from [Program 20-4](#), which we will examine momentarily.

```
29 int numChars(char search, string str, int subscript)
30 {
31     if (subscript >= str.length())
32     {
33         // Base case: The end of the string is reached.
34         return 0;
35     }
36     else if (str[subscript] == search)
37     {
38         // Recursive case: A matching character was found.
39         // Return 1 plus the number of times the search
40         // character appears in the rest of the string.
41         return 1 + numChars(search, str, subscript+1);
42     }
43     else
44     {
45         // Recursive case: A character that does not match the
46         // search character was found. Return the number of times
47         // the search character appears in the rest of the string.
48         return numChars(search, str, subscript+1);
49     }
50 }
```

The function's parameters are

- `search`: The character to be searched for and counted
- `str`: a `string` object containing the string to be searched
- `subscript`: The starting subscript for the search

When this function examines a character in the string, three possibilities exist:

- The end of the string has been reached. This is the base case, because there are no more characters to search.

- A character that matches the search character is found. This is a recursive case because we still have to search the rest of the string.
- A character that does not match the search character is found. This is also a recursive case because we still have to search the rest of the string.

Let's take a closer look at the code. The first `if` statement, in line 31, determines whether the end of the string has been reached:

```
if (subscript >= str.length())
```


Reaching the end of the string is the base case of the problem. If the end of the string has been reached, the function returns 0, indicating 0 matching characters were found. Otherwise, the following `else if` clause, in lines 36 through 42, is executed:

```
else if (str[subscript] == search)
{
    // Recursive case: A matching character was found.
    // Return 1 plus the number of times the search
    // character appears in the rest of the string.
    return 1 + numChars(search, str, subscript+1);
}
```

If `str[subscript]` contains the search character, then we have found one matching character. But because we have not reached the end of the string, we must continue to search the rest of the string for more matching characters. So, at this point, the function performs a recursive call. The `return` statement returns 1 plus the number of times the search character appears in the string, starting at `subscript + 1`. In essence, this statement returns 1 plus the number of times the search character appears in the rest of the string.

Finally, if `str[subscript]` does not contain the search character, the following `else` clause in lines 43 through 49 is executed:

```
else
{
    // Recursive case: A character that does not match the
    // search character was found. Return the number of times
    // the search character appears in the rest of the string.
    return numChars(search, str, subscript+1);
}
```

The `return` statement in line 48 makes a recursive call to search the remainder of the string. In essence, this code returns the number of times the search character appears in the rest of the string. **Program 20-4**  demonstrates the function.

## Program 20-4

```
1 // This program demonstrates a recursive function for counting
2 // the number of times a character appears in a string.
3 #include <iostream>
4 #include <string>
5 using namespace std;
6
7 // Function prototype
8 int numChars(char, string, int);
9
10 int main()
11 {
12     string str = "abcddddef";
13
14     // Display the number of times the letter
15     // 'd' appears in the string.
16     cout << "The letter d appears "
17          << numChars('d', str, 0) << " times.\n";
18
19     return 0;
20 }
21
22 /*******
23 // Function numChars. This recursive function *
24 // counts the number of times the character *
25 // search appears in the string str. The search *
26 // begins at the subscript stored in subscript. *
27 /*******
28
29 int numChars(char search, string str, int subscript)
30 {
31     if (subscript >= str.length())
32     {
33         // Base case: The end of the string is reached.
34         return 0;
35     }
36     else if (str[subscript] == search)
37     {
```

```
38 // Recursive case: A matching character was found.
39 // Return 1 plus the number of times the search
40 // character appears in the rest of the string.
41 return 1 + numChars(search, str, subscript+1);
42 }
43 else
44 {
45 // Recursive case: A character that does not match the
46 // search character was found. Return the number of times
47 // the search character appears in the rest of the string.
48 return numChars(search, str, subscript+1);
49 }
50 }
```

### Program Output

```
The letter d appears 4 times.
```

# Direct and Indirect Recursion

The examples we have discussed so far show recursive functions that directly call themselves. This is known as *direct recursion*. There is also the possibility of creating *indirect recursion* in a program. This occurs when function A calls function B, which in turn calls function A. There can even be several functions involved in the recursion. For example, function A could call function B, which could call function C, which calls function A.

## Checkpoint

20.1 What happens if a recursive function never returns?

20.2 What is a recursive function's base case?

20.3 What will the following program display?

```
#include <iostream>
using namespace std;
// Function prototype
void showMe(int arg);
int main()
{
    int num = 0;
    showMe(num);
    return 0;
}
void showMe(int arg)
{
    if (arg < 10)
        showMe(++arg);
    else
        cout << arg << endl;
}
```

20.4 What is the difference between direct and indirect recursion?



## 20.3 Focus on Problem Solving and Program Design: The Recursive `gcd` Function


### Concept:

The `gcd` function uses recursion to find the greatest common divisor (GCD) of two numbers.

Our next example of recursion is the calculation of the greatest common divisor, or GCD, of two numbers. Using Euclid's algorithm, the GCD of two positive integers,  $x$  and  $y$ , is:

$\text{gcd}(x, y) = y$ ; if  $y$  divides  $x$  evenly

$\text{gcd}(y, \text{remainder of } x/y)$ ; otherwise

The definition above states the GCD of  $x$  and  $y$  is  $y$  if  $x/y$  has no remainder. Otherwise, the answer is the GCD of  $y$  and the remainder of  $x/y$ . [Program 20-5](#)  shows the recursive C++ implementation.

## Program 20-5

```
1 // This program demonstrates a recursive
function to calculate
2 // the greatest common divisor (gcd) of two
numbers.
3 #include <iostream>
4 using namespace std;
5
6 // Function prototype
7 int gcd(int, int);
8
9 int main()
10 {
11     int num1, num2;
12
13     // Get two numbers.
14     cout << "Enter two integers: ";
15     cin >> num1 >> num2;
16
17     // Display the GCD of the numbers.
18     cout << "The greatest common divisor of "
<< num1;
19     cout << " and " << num2 << " is ";
20     cout << gcd(num1, num2) << endl;
```

```

21     return 0;
22 }
23
24
//*****
*****
25 // Definition of gcd. This function uses
recursion to *
26 // calculate the greatest common divisor of
two integers, *
27 // passed into the parameters x and y.
*
28
//*****
*****
29
30 int gcd(int x, int y)
31 {
32     if (x % y == 0)
33         return y; // Base case
34     else
35         return gcd(y, x % y); // Recursive
case
36 }

```

**Program Output with Example Input Shown in Bold**

Enter two integers: **49 28** Enter

The greatest common divisor of 49 and 28 is

7

## 20.4 Focus on Problem Solving and Program Design: Solving Recursively Defined Problems

### **Concept:**

Some mathematical problems are designed for a recursive solution.

Some mathematical problems are designed to be solved recursively. One well-known example is the calculation of *Fibonacci numbers*. The Fibonacci numbers, named after the Italian mathematician Leonardo Fibonacci (born circa 1170), are the following sequence:

0, 1, 1, 2, 3, 5, 8, 13, 21, 34, 55, 89, 144, 233, ...

Notice after the second number, each number in the series is the sum of the two previous numbers. The Fibonacci series can be defined as

$$F_0 = 0$$

$$F_1 = 1$$

$$F_N = F_{N-1} + F_{N-2} \text{ for } N \geq 2.$$

A recursive C++ function to calculate the  $n$ th number in the Fibonacci series is shown here:

```
int fib(int n)
{
    if (n <= 0)
        return 0;
    else if (n == 1)
        return 1;
    else
        return fib(n - 1) + fib(n - 2);
}
```

The function is demonstrated in [Program 20-6](#), which displays the first 10 numbers in the Fibonacci series.

## Program 20-6

```
1 // This program demonstrates a recursive
function
2 // that calculates Fibonacci numbers.
3 #include <iostream>
4 using namespace std;
5
6 // Function prototype
7 int fib(int);
8
9 int main()
10 {
11     cout << "The first 10 Fibonacci numbers
are:\n";
12     for (int x = 0; x < 10; x++)
13         cout << fib(x) << " ";
14     cout << endl;
15     return 0;
16 }
17
18 //*****
19 // Function fib. Accepts an int argument *
20 // in n. This function returns the nth *
21 // Fibonacci number. *
```

```
22  //*****
23
24  int fib(int n)
25  {
26      if (n <= 0)
27          return 0;    // Base case
28      else if (n == 1)
29          return 1;    // Base case
30      else
31          return fib(n - 1) + fib(n - 2);    //
Recursive case
32  }
```

## Program Output

```
The first 10 Fibonacci numbers are:
0 1 1 2 3 5 8 13 21 34
```

Another such example is Ackermann's function. A Programming Challenge at the end of this chapter will ask you to write a recursive function that calculates Ackermann's function.



## 20.5 Focus on Problem Solving and Program Design: Recursive Linked List Operations

### Concept:

Recursion can be used to traverse the nodes in a linked list.

Recall in [Chapter 18](#), we discussed a class named `NumberList` that holds a linked list of `double` values. In this section, we will modify the class by adding recursive member functions. The functions will use recursion to traverse the linked list and perform the following operations:

- Count the number of nodes in the list.

To count the number of nodes in the list by recursion, we introduce two new member functions: `numNodes` and `countNodes`. `countNodes` is a private member function that uses recursion, and `numNodes` is the public interface that calls it.

- Display the value of the list nodes in reverse order.

To display the nodes in the list in reverse order, we introduce two new member functions: `displayBackwards` and `showReverse`. `showReverse` is a private member function that uses recursion, and `displayBackwards` is the public interface that calls it.

The class declaration, which is saved in `NumberList.h`, is shown here:

```
1 // Specification file for the NumberList class
2 #ifndef NUMBERLIST_H
3 #define NUMBERLIST_H
4
5 class NumberList
6 {
7     private:
8         // Declare a structure for the list
9         struct ListNode
10        {
11            double value;
12            struct ListNode *next;
13        };
14
15        ListNode *head;    // List head pointer
16
17        // Private member functions
18        int countNodes(ListNode *) const;
19        void showReverse(ListNode *) const;
20
21    public:
22        // Constructor
23        NumberList()
24            { head = nullptr; }
25
26        // Destructor
27        ~NumberList();
```

```
28
29     // Linked List Operations
30     void appendNode(double);
31     void insertNode(double);
32     void deleteNode(double);
33     void displayList() const;
34     int numNodes() const
35         { return countNodes(head); }
36     void displayBackwards() const
37         { showReverse(head); }
38 };
39 #endif
```

# Counting the Nodes in the List

The `numNodes` function is declared inline. It simply calls the `countNodes` function and passes the `head` pointer as an argument. (Because the `head` pointer, which is private, must be passed to `countNodes`, the `numNodes` function is needed as an interface.)

The function definition for `countNodes` is shown here:

```
173 int NumberList::countNodes(ListNode *nodePtr) const
174 {
175     if (nodePtr != nullptr)
176         return 1 + countNodes(nodePtr->next);
177     else
178         return 0;
179 }
```

The function's recursive logic can be expressed as:

```
If the current node has a value
    Return 1 + the number of the remaining nodes
Else
    Return 0
End If
```

**Program 20-7**  demonstrates the function.

## Program 20-7

```
1 // This program counts the nodes in a list.
2 #include <iostream>
3 #include "NumberList.h"
4 using namespace std;
5
6 int main()
7 {
8     const int MAX = 10; // Maximum number of
values
9
10    // Define a NumberList object.
11    NumberList list;
12
13    // Build the list with a series of
numbers.
14    for (int x = 0; x < MAX; x++)
15        list.insertNode(x);
16
17    // Display the number of nodes in the
list.
18    cout << "The number of nodes is "
19        << list.numNodes() << endl;
```

```
20     return 0;  
21 }
```

## Program Output

```
The number of nodes is 10
```



# Displaying List Nodes in Reverse Order

The technique for displaying the list nodes in reverse order is designed like the node counting procedure: A public member function, which serves as an interface, passes the head pointer to a private member function. The public `displayBackwards` function, declared inline, is the interface. It calls the `showReverse` function and passes the `head` pointer as an argument. The function definition for `showReverse` is shown here:

```
187 void NumberList::showReverse(ListNode *nodePtr) const
188 {
189     if (nodePtr != nullptr)
190     {
191         showReverse(nodePtr->next);
192         cout << nodePtr->value << " ";
193     }
194 }
```

The base case for the function is `nodePtr` being set to `nullptr`. When this is true, the function has reached the last node in the list, so it returns. It is not until this happens that any instances of the `cout` statement execute. The instance of the function whose

`nodePtr` variable points to the last node in the list will be the first to execute the `cout` statement. It will then return, and the previous instance of the function will execute its `cout` statement. This repeats until all the instances of the function have returned.

The modified class declaration is stored in `NumberList.h`, and its member function implementation is in `NumberList.cpp`. The remainder of the class implementation is unchanged from **Chapter 18**, so it is not shown here. **Program 20-8** demonstrates the function.

## Program 20-8

```
1 // This program demonstrates the recursive
function
2 // for displaying the list's nodes in reverse.
3 #include <iostream>
4 #include "NumberList.h"
5 using namespace std;
6
7 int main()
8 {
9     const double MAX = 10.0; // Upper limit of
values
10
11     // Create a NumberList object.
12     NumberList list;
13
14     // Add a series of numbers to the list.
15     for (double x = 1.5; x < MAX; x += 1.1)
16         list.appendNode(x);
17
18     // Display the values in the list.
19     cout << "Here are the values in the
list:\n";
20     list.displayList();
```

```
21
22     // Display the values in reverse order.
23     cout << "Here are the values in reverse
order:\n";
24     list.displayBackwards();
25     return 0;
26 }
```

## Program Output

```
Here are the values in the list:
1.5
2.6
3.7
4.8
5.9
7
8.1
9.2

Here are the values in reverse order:
9.2 8.1 7 5.9 4.8 3.7 2.6 1.5
```

## 20.6 Focus on Problem Solving and Program Design: A Recursive Binary Search Function

### **Concept:**

The binary search algorithm can be defined as a recursive function.

In [Chapter 8](#), you learned about the binary search algorithm and saw an iterative example written in C++. The binary search algorithm can also be implemented recursively. For example, the procedure can be expressed as


If `array[middle]` equals the search value, then the value is found.

Else, if `array[middle]` is less than the search value, perform a binary search on the upper half of the array.

Else, if `array[middle]` is greater than the search value, perform a binary search on the lower half of the array.

The recursive binary search algorithm is an example of breaking a problem down into smaller pieces until it is solved. A recursive binary search function is shown here:

```
int binarySearch(int array[], int first, int last, int value)
{
    int middle;    // Midpoint of search
    if (first > last)
        return -1;
    middle = (first + last) / 2;
    if (array[middle] == value)
        return middle;
    if (array[middle] < value)
        return binarySearch(array, middle+1, last, value);
    else
        return binarySearch(array, first, middle-1, value);
}
```

The first parameter, `array`, is the array to be searched. The next parameter, `first`, holds the subscript of the first element in the search range (the portion of the array to be searched). The next parameter, `last`, holds the subscript of the last element in the search range. The last parameter, `value`, holds the value to be searched for. Like the iterative version, this function returns the subscript of the value if it is found, or `- 1` if the value is not found. [Program 20-9](#)  demonstrates the function.

## Program 20-9

```
1 // This program demonstrates the recursive
binarySearch function.
2 #include <iostream>
3 using namespace std;
4
5 // Function prototype
6 int binarySearch(int [], int, int, int);
7
8 const int SIZE = 20; // Array size
9
10 int main()
11 {
12     // Define an array of employee ID numbers
13     int tests[SIZE] = {101, 142, 147, 189,
14                       199, 207, 222,
15                       234, 289, 296, 310, 319,
16                       388, 394,
17                       417, 429, 447, 521, 536,
18                       600};
19
20     int empID; // To hold an ID number
21     int results; // To hold the search
results
22 }
```



```

19     // Get an employee ID number to search
for.
20     cout << "Enter the Employee ID you wish to
search for: ";
21     cin >> empID;
22
23     // Search for the ID number in the array.
24     results = binarySearch(tests, 0, SIZE - 1,
empID);
25
26     // Display the results of the search.
27     if (results == -1)
28         cout << "That number does not exist in
the array.\n";
29     else
30     {
31         cout << "That ID is found at element "
<< results;
32         cout << " in the array\n";
33     }
34     return 0;
35 }
36
37
//*****
*****
38 // The binarySearch function performs a

```

```

recursive binary search *
39 // on a range of elements of an integer array
passed into the *
40 // parameter array. The parameter first holds
the subscript of *
41 // the range's starting element, and last
holds the subscript *
42 // of the range's last element. The parameter
value holds the *
43 // search value. If the search value is found,
its array *
44 // subscript is returned. Otherwise, -1 is
returned indicating *
45 // the value was not in the array.
*
46
//*****
*****
47
48 int binarySearch(int array[], int first, int
last, int value)
49 {
50     int middle; // Midpoint of search
51
52     if (first > last)
53         return -1;
54     middle = (first + last)/2;

```

```
55     if (array[middle]==value)
56         return middle;
57     if (array[middle]<value)
58         return binarySearch(array,
middle+1,last,value);
59     else
60         return binarySearch(array,
first,middle-1,value);
61 }
```

### Program Output with Example Input Shown in Bold

```
Enter the Employee ID you wish to search
for: 521 Enter
That ID is found at element 17 in the array
```

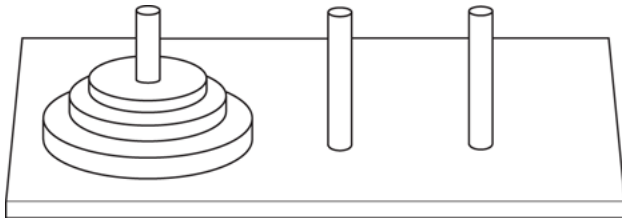
## 20.7 The Towers of Hanoi

### Concept:

The repetitive steps involved in solving the Towers of Hanoi game can be easily implemented in a recursive algorithm.

The Towers of Hanoi is a mathematical game often used in computer science textbooks to illustrate the power of recursion. The game uses three pegs and a set of discs with holes through their centers. The discs are stacked on one of the pegs as shown in [Figure 20-4](#).

**Figure 20-4** The pegs and discs in the Towers of Hanoi game



Notice the discs are stacked on the leftmost peg, in order of size with the largest disc at the bottom. The game is based on a legend in which a group of monks in a temple in Hanoi have a similar set of pegs with 64 discs. The job of the monks is to move the discs from the first peg to the third peg. The middle peg can be used as a temporary holder. Furthermore, the monks must follow these rules while moving the discs:

- Only one disc may be moved at a time.
- A disc cannot be placed on top of a smaller disc.
- All discs must be stored on a peg except while being moved.

According to the legend, when the monks have moved all of the discs from the first peg to the last peg, the world will come to an end.

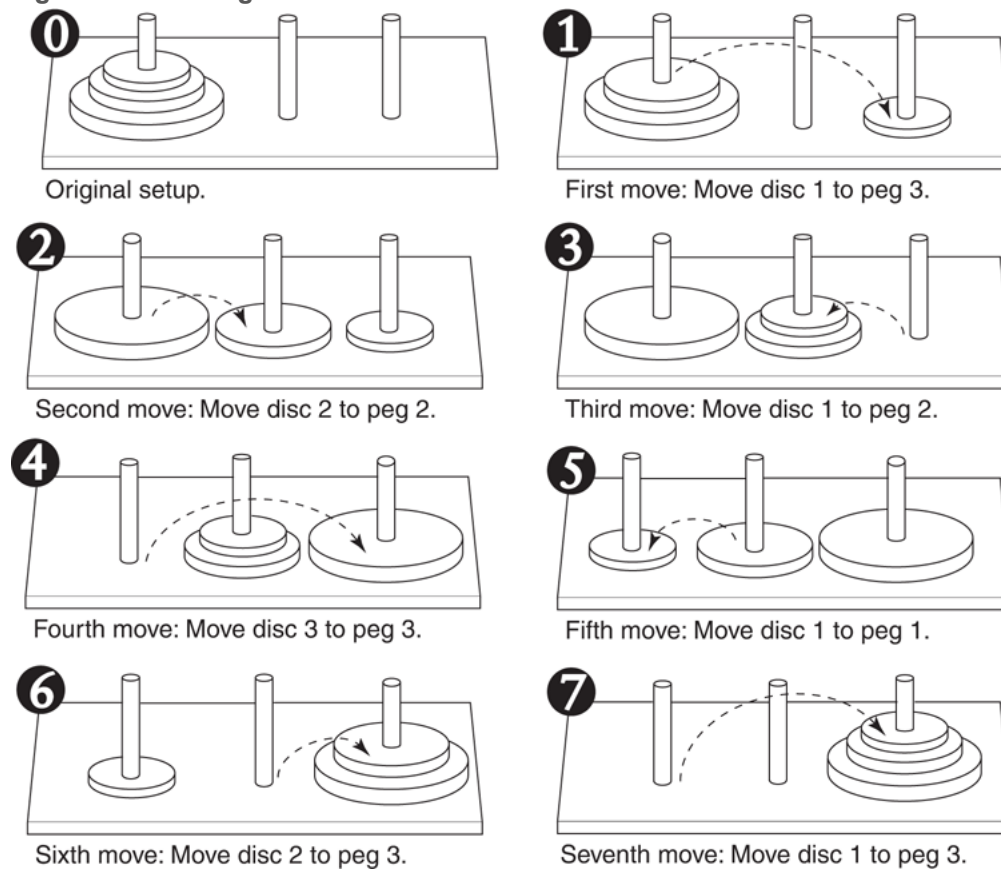
To play the game, you must move all of the discs from the first peg to the third peg, following the same rules as the monks. Let's look at some example solutions to this game, for different numbers of discs. If you only have one disc, the solution to the game is simple: move the disc from peg 1 to peg 3. If you have two discs, the solution requires three moves:

- Move disc 1 to peg 2.

- Move disc 2 to peg 3.
- Move disc 1 to peg 3.

Notice this approach uses peg 2 as a temporary location. The complexity of the moves continues to increase as the number of discs increases. To move three discs requires the seven moves shown in [Figure 20-5](#).

**Figure 20-5** Moving three discs



The following statement describes the overall solution to the problem:

*Move  $n$  discs from peg 1 to peg 3 using peg 2 as a temporary peg.*

The following pseudocode algorithm can be used as the basis of a recursive function that simulates the solution to the game. Notice in this algorithm we use the variables  $A$ ,  $B$ , and  $C$  to hold peg numbers.

```
To move n discs from peg A to peg C, using peg B as a temporary peg
If n > 0 Then
    Move n - 1 discs from peg A to peg B, using peg C as a temporary peg
    Move the remaining disc from the peg A to peg C
    Move n - 1 discs from peg B to peg C, using peg A as a temporary peg
End If
```

The base case for the algorithm is reached when there are no more discs to move. The following code is for a function that implements this algorithm. Note the function does not actually move anything, but displays instructions indicating all of the disc moves to make.

```
void moveDiscs(int num, int fromPeg, int toPeg, int tempPeg)
{
    if (num > 0)
    {
        moveDiscs(num - 1, fromPeg, tempPeg, toPeg);
        cout << "Move a disc from peg " << fromPeg
            << " to peg " << toPeg << endl;
        moveDiscs(num - 1, tempPeg, toPeg, fromPeg);
    }
}
```

This function accepts arguments into the following three parameters:

If `num` is greater than 0, then there are discs to move. The first recursive call is


```
moveDiscs(num - 1, fromPeg, tempPeg, toPeg);
```

This statement is an instruction to move all but one disc from `fromPeg` to `tempPeg`, using `toPeg` as a temporary peg. The next statement is

```
cout << "Move a disc from peg " << fromPeg
    << " to peg " << toPeg << endl;
```

This simply displays a message indicating that a disc should be moved from `fromPeg` to `toPeg`. Next, another recursive call is executed:

```
moveDiscs(num - 1, tempPeg, toPeg, fromPeg);
```

This statement is an instruction to move all but one disc from `tempPeg` to `toPeg`, using `fromPeg` as a temporary peg. [Program 20-10](#)  demonstrates this function.

## Program 20-10

```
1 // This program displays a solution to the Towers of
2 // Hanoi game.
3 #include <iostream>
4 using namespace std;
5
6 // Function prototype
7 void moveDiscs(int, int, int, int);
8
9 int main()
10 {
11     const int NUM_DISCS = 3; // Number of discs to move
12     const int FROM_PEG = 1; // Initial "from" peg
13     const int TO_PEG = 3; // Initial "to" peg
14     const int TEMP_PEG = 2; // Initial "temp" peg
15
16     // Play the game.
17     moveDiscs(NUM_DISCS, FROM_PEG, TO_PEG, TEMP_PEG);
18     cout << "All the pegs are moved!\n";
19     return 0;
20 }
21
22 //*****
23 // The moveDiscs function displays a disc move in *
24 // the Towers of Hanoi game. *
25 // The parameters are: *
26 // num: The number of discs to move. *
27 // fromPeg: The peg to move from. *
28 // toPeg: The peg to move to. *
29 // tempPeg: The temporary peg. *
30 //*****
31
32 void moveDiscs(int num, int fromPeg, int toPeg, int tempPeg)
33 {
34     if (num > 0)
35     {
36         moveDiscs(num - 1, fromPeg, tempPeg, toPeg);
37         cout << "Move a disc from peg " << fromPeg
```



```
38         << " to peg " << toPeg << endl;
39         moveDiscs(num - 1, tempPeg, toPeg, fromPeg);
40     }
41 }
```

## Program Output

```
Move a disc from peg 1 to peg 3
Move a disc from peg 1 to peg 2
Move a disc from peg 3 to peg 2
Move a disc from peg 1 to peg 3
Move a disc from peg 2 to peg 1
Move a disc from peg 2 to peg 3
Move a disc from peg 1 to peg 3
All the pegs are moved!
```

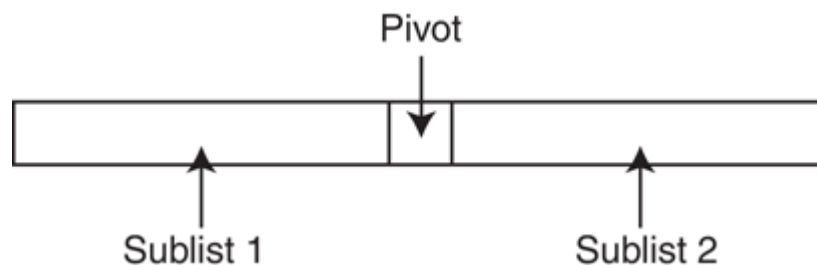
# 20.8 Focus on Problem Solving and Program Design: The QuickSort Algorithm

## Concept:

The QuickSort algorithm uses recursion to efficiently sort a list.

The QuickSort algorithm is a popular general-purpose sorting routine developed in 1960 by C.A.R. Hoare. It can be used to sort lists stored in arrays or linear linked lists. It sorts a list by dividing it into two sublists. Between the sublists is a selected value known as the *pivot*. This is illustrated in [Figure 20-6](#).

**Figure 20-6** A partitioned data set



Notice in the figure sublist 1 is positioned to the left of (before) the pivot, and sublist 2 is positioned to the right of (after) the pivot. Once a pivot value has been selected, the algorithm exchanges the other values in the list until all the elements in sublist 1 are less than the pivot, and all the elements in sublist 2 are greater than the pivot.

Once this is done, the algorithm repeats the procedure on sublist 1, then on sublist 2. The recursion stops when there is only one element in a sublist. At that point, the original list is completely sorted.

The algorithm is coded primarily in two functions: `quickSort` and `partition`. `quickSort` is a recursive function. Its pseudocode is shown here:

```
quickSort:  
If Starting Index < Ending Index  
    Partition the List around a Pivot  
    quickSort Sublist 1  
    quickSort Sublist 2  
End If
```

Here is the C++ code for the quickSort function:

```

void quickSort(int set[], int start, int end)
{
    int pivotPoint;
    if (start < end)
    {
        // Get the pivot point.
        pivotPoint = partition(set, start, end);
        // Sort the first sublist.
        quickSort(set, start, pivotPoint - 1);
        // Sort the second sublist.
        quickSort(set, pivotPoint + 1, end);
    }
}

```

This version of quickSort works with an array of integers. Its first argument is the array holding the list that is to be sorted. The second and third arguments are the starting and ending subscripts of the list.

The subscript of the pivot element is returned by the partition function. partition not only determines which element will be the pivot, but also controls the rearranging of the other values in the list. Our version of this function selects the element in the middle of the list as the pivot, then scans the remainder of the list searching for values less than the pivot.

The code for the partition function is shown here:

```
int partition(int set[], int start, int end)
{
    int pivotValue, pivotIndex, mid;
    mid = (start + end) / 2;
    swap(set[start], set[mid]);
    pivotIndex = start;
    pivotValue = set[start];
    for (int scan = start + 1; scan <= end; scan++)
    {
        if (set[scan] < pivotValue)
        {
            pivotIndex++;
            swap(set[pivotIndex], set[scan]);
        }
    }
    swap(set[start], set[pivotIndex]);
    return pivotIndex;
}
```



## Note:

The `partition` function does not initially sort the values into their final order. Its job is only to move the values that are less than the pivot to the pivot's left, and move the values that are greater than the pivot to the pivot's right. As long as that condition is met, they may appear in any order. The ultimate sorting order of the entire list is achieved cumulatively, though the recursive calls to `quickSort`.

There are many different ways of partitioning the list. As previously stated, the method shown in the function above selects the middle value as the pivot. That value is then moved to the beginning of the list (by exchanging it with the value stored there). This simplifies the next step, which is to scan the list.

A `for` loop scans the remainder of the list, and when an element is found whose value is less than the pivot, that value is moved to a location left of the pivot point.

A third function, `swap`, is used to swap the values found in any two elements of the list. The function is shown below:

```
void swap(int &value1, int &value2)
{
    int temp = value1;
    value1 = value2;
    value2 = temp;
}
```

**Program 20-11**  demonstrates the QuickSort algorithm.

## Program 20-11

```
1 // This program demonstrates the QuickSort
Algorithm.
2 #include <iostream>
3 using namespace std;
4
5 // Function prototypes
6 void quickSort(int [], int, int);
7 int partition(int [], int, int);
8 void swap(int &, int &);
9
10 int main()
11 {
12     const int SIZE = 10; // Array size
13     int count;           // Loop counter
14     int array[SIZE] = {7, 3, 9, 2, 0, 1, 8, 4,
15 6, 5};
16     // Display the array contents.
17     for (count = 0; count < SIZE; count++)
18         cout << array[count] << " ";
19     cout << endl;
20
21     // Sort the array.
```



```

22     quickSort(array, 0, SIZE - 1);
23
24     // Display the array contents.
25     for (count = 0; count < SIZE; count++)
26         cout << array[count] << " ";
27     cout << endl;
28     return 0;
29 }
30
31
//*****
32 // quickSort uses the quicksort algorithm to
*
33 // sort set, from set[start] through set[end].
*
34
//*****
35
36 void quickSort(int set[], int start, int end)
37 {
38     int pivotPoint;
39
40     if (start < end)
41     {
42         // Get the pivot point.
43         pivotPoint = partition(set, start,
end);

```

```

44         // Sort the first sublist.
45         quickSort(set, start, pivotPoint - 1);
46         // Sort the second sublist.
47         quickSort(set, pivotPoint + 1, end);
48     }
49 }
50
51
52 //*****
53 // partition selects the value in the middle
54 // of the array *
55 // array set as the pivot. The list is
56 // rearranged so that *
57 // all the values less than the pivot are on
58 // its left *
59 // and all the values greater than pivot are
60 // on its right. *
61
62 //*****
63
64 int partition(int set[], int start, int end)
65 {
66     int pivotValue, pivotIndex, mid;
67
68     mid = (start + end) / 2;

```

```
63     swap(set[start], set[mid]);
64     pivotIndex = start;
65     pivotValue = set[start];
66     for (int scan = start + 1; scan <= end;
scan++)
67     {
68         if (set[scan] < pivotValue)
69         {
70             pivotIndex++;
71             swap(set[pivotIndex], set[scan]);
72         }
73     }
74     swap(set[start], set[pivotIndex]);
75     return pivotIndex;
76 }
77
78 //*****
79 // swap simply exchanges the contents of *
80 // value1 and value2. *
81 //*****
82
83 void swap(int &value1, int &value2)
84 {
85     int temp = value1;
86
87     value1 = value2;
```

```
88     value2 = temp;  
89 }
```

## Program Output

```
7 3 9 2 0 1 8 4 6 5  
0 1 2 3 4 5 6 7 8 9
```

## 20.9 Exhaustive Algorithms

### **Concept:**

An exhaustive algorithm is one that finds a best combination of items by looking at all the possible combinations.

Recursion is helpful if you need to examine many possible combinations and identify the best combination. For example, consider all the different ways you can make change for \$1.00 using our system of coins:

1 dollar piece, or

2 fifty-cent pieces, or


4 quarters, or

1 fifty-cent piece and 2 quarters, or

3 quarters, 2 dimes, and 1 nickel, or

... *there are many more possibilities.*

Although there are many ways to make change for \$1.00, some ways are better than others. For example, you would probably rather give a single dollar piece instead of 100 pennies.

An algorithm that looks at all the possible combinations of items in order to find the best combination of items is called an exhaustive algorithm. **Program 20-12**  presents a recursive function that exhaustively tries all the possible combinations of coins. The program then displays the total number of combinations that can be used to make the specified change, and the best combination of coins.

## Program 20-12

```
1 // This program demonstrates a recursive
function that exhaustively
2 // searches through all possible combinations
of coin values to find
3 // the best way to make change for a
specified amount.
4 #include <iostream>
5 using namespace std;
6
7 // Constants
8 const int MAX_COINS_CHANGE = 100; // Max
number of coins to give in change
9 const int MAX_COIN_VALUES = 6; // Max
number of coin values
10 const int NO_SOLUTION = INT_MAX; //
Indicates no solution
11
12 // Function prototype
13 void makeChange(int, int, int[], int);
14
15 // coinValues - global array of coin values
to choose from
16 int coinValues[MAX_COIN_VALUES] = {100, 50,
```

```

25, 10, 5, 1 };
17
18 // bestCoins - global array of best coins to
make change with
19 int bestCoins[MAX_COINS_CHANGE];
20
21 // Global variables
22 int numBestCoins = NO_SOLUTION, // Number of
coins in bestCoins
23     numSolutions = 0,           // Number of
ways to make change
24     numCoins;                  // Number of
allowable coins
25
26
27 int main()
28 {
29     int coinsUsed[MAX_COINS_CHANGE], // List
of coins used
30     numCoinsUsed = 0,               // The
number of coins used
31     amount;                          // The
amount to make change for
32
33     // Display the possible coin values.
34     cout << "Here are the valid coin values,
in cents: ";

```



```
35     for (int index = 0; index < 5; index++)
36         cout << coinValues[index] << " ";
37     cout << endl;
38
39     // Get input from the user.
40     cout << "Enter the amount of cents (as an
integer) "
41         << "to make change for: ";
42     cin >> amount;
43     cout << "What is the maximum number of
coins to give as change? ";
44     cin >> numCoins;
45
46     // Call the recursive function.
47     makeChange(numCoins, amount, coinsUsed,
numCoinsUsed);
48
49     // Display the results.
50     cout << "Number of possible
combinations: " << numSolutions << endl;
51     cout << "Best combination of coins:\n";
52     if (numBestCoins == NO_SOLUTION)
53         cout << "\tNo solution\n";
54     else
55     {
56         for (int count = 0; count <
numBestCoins; count++)
```

```

57         cout << bestCoins[count] << " ";
58     }
59     cout << endl;
60     return 0;
61 }
62
63
//*****
*****
64 // Function makeChange. This function uses
the following parameters: *
65 // coinsLeft - The number of coins left to
choose from. *
66 // amount - The amount to make change for.
*
67 // coinsUsed - An array that contains the
coin values used so far. *
68 // numCoinsUsed - The number of values in the
coinsUsed array. *
69 //
*
70 // This recursive function finds all the
possible ways to make change *
71 // for the value in amount. The best
combination of coins is stored in *
72 // the array bestCoins.
*

```

```

73
//*****
*****
74
75 void makeChange(int coinsLeft, int amount,
int coinsUsed[],
76 int numCoinsUsed)
77 {
78 int coinPos, // To calculate array
position of coin being used
79 count; // Loop counter
80
81 if (coinsLeft == 0) // If no more coins
are left
82 return;
83 else if (amount < 0) // If amount to
make change for is negative
84 return;
85 else if (amount == 0) // If solution is
found
86 {
87 // Store as bestCoins if best
88 if (numCoinsUsed < numBestCoins)
89 {
90 for (count = 0; count <
numCoinsUsed; count++)
91 bestCoins[count] =

```

```

coinsUsed[count];
92         numBestCoins = numCoinsUsed;
93     }
94         numSolutions++;
95         return;
96     }
97
98     // Find the other combinations using the
coin
99     coinPos = numCoins - coinsLeft;
100    coinsUsed[numCoinsUsed] =
coinValues[coinPos];
101    numCoinsUsed++;
102    makeChange(coinsLeft, amount -
coinValues[coinPos],
103              coinsUsed, numCoinsUsed);
104
105    // Find the other combinations not using
the coin.
106    numCoinsUsed--;
107    makeChange(coinsLeft - 1, amount,
coinsUsed, numCoinsUsed);
108 }

```

**Program Output with Example Input Shown in Bold**

Here are the valid coin values, in cents:

100 50 25 10 5 1

Enter the amount of cents (as an integer) to  
make change for: **62** Enter

What is the maximum number of coins to give  
as change? **6** Enter

Number of possible combinations: **77**

Best combination of coins:

50 10 1 1

# 20.10 Focus on Software Engineering: Recursion versus Iteration

## **Concept:**

Recursive algorithms can also be coded with iterative control structures. There are advantages and disadvantages to each approach.

Any algorithm that can be coded with recursion can also be coded with an iterative control structure, such as a `while` loop. Both approaches achieve repetition, but which is best to use?

There are several reasons not to use recursion. Recursive algorithms are certainly less efficient than iterative algorithms. Each time a function is called, the system incurs overhead that is not necessary with a loop. Also, in many cases an iterative solution may be more evident than a recursive one. In fact, the majority of repetitive programming tasks are best done with loops.

Some problems, however, are more easily solved with recursion than with iteration. For example, the mathematical definition of the GCD formula is well-suited for a recursive approach. The QuickSort algorithm is also an example of a function that is easier to code with recursion than iteration.

The speed and amount of memory available to modern computers diminishes the performance impact of recursion so much that inefficiency is no longer a strong argument against it. Today, the choice of recursion or iteration is primarily a design decision. If a problem is more easily solved with a loop, that should be the approach you take. If recursion results in a better design, that is the choice you should make.

# Review Questions and Exercises

## Short Answer

1. What is the base case of each of the recursive functions listed in Questions 12, 13, and 14?
2. What type of recursive function do you think would be more difficult to debug, one that uses direct recursion, or one that uses indirect recursion? Why?
3. Which repetition approach is less efficient, a loop or a recursive function? Why?
4. When should you choose a recursive algorithm over an iterative algorithm?
5. Explain what is likely to happen when a recursive function that has no way of stopping executes.



# Fill-in-the-Blank

6. The \_\_\_\_\_ of recursion is the number of times a function calls itself.
7. A recursive function's solvable problem is known as its \_\_\_\_\_. This causes the recursion to stop.
8. \_\_\_\_\_ recursion is when a function explicitly calls itself.
9. \_\_\_\_\_ recursion is when function A calls function B, which in turns calls function A.

# Algorithm Workbench

10. Write a recursive function to return the number of times a specified number occurs in an array.
11. Write a recursive function to return the largest value in an array.

# Predict the Output

What is the output of the following programs?

12.

```
#include <iostream>
using namespace std;
int function(int);
int main()
{
    int x = 10;
    cout << function(x) << endl;
    return 0;
}
int function(int num)
{
    if (num <= 0)
        return 0;
    else
        return function(num - 1) + num;
}
```

13.

```
#include <iostream>
using namespace std;
void function(int);
int main()
{
    int x = 10;
    function(x);
    return 0;
}
void function(int num)
{
    if (num > 0)
    {
        for (int x = 0; x < num; x++)
            cout << '*';
        cout << endl;
        function(num - 1);
    }
}
```

14.

```
#include <iostream>
#include <string>
using namespace std;
void function(string, int, int);
int main()
{
    string mystr = "Hello";
    cout << mystr << endl;
    function(mystr, 0, mystr.size());
    return 0;
}
void function(string str, int pos, int size)
{
    if (pos < size)
    {
        function(str, pos + 1, size);
        cout << str[pos];
    }
}
```

# Programming Challenges

## 1. Iterative Factorial

Write an iterative version (using a loop instead of recursion) of the factorial function shown in this chapter. Test it with a driver program.

## 2. Recursive Conversion

Convert the following function to one that uses recursion.

```
void sign(int n)
{
    while (n > 0)
        cout << "No Parking\n";
    n--;
}
```

Demonstrate the function with a driver program.

## 3. QuickSort Template

Create a template version of the QuickSort algorithm that will work with any data type. Demonstrate the template with a driver function.

## 4. Recursive Array Sum

Write a function that accepts an array of integers and a number indicating the number of elements as arguments. The function should recursively calculate the sum of all the

numbers in the array. Demonstrate the function in a driver program.

## 5. Recursive Multiplication`



### Solving the Recursive Multiplication Problem

Write a recursive function that accepts two arguments into the parameters `x` and `y`. The function should return the value of `x` times `y`. Remember, multiplication can be performed as repeated addition:

$$7 * 4 = 4 + 4 + 4 + 4 + 4 + 4 + 4$$

## 6. Recursive Power Function

Write a function that uses recursion to raise a number to a power. The function should accept two arguments: the number to be raised and the exponent. Assume that the exponent is a nonnegative integer. Demonstrate the function in a program.

## 7. Sum of Numbers

Write a function that accepts an integer argument and returns the sum of all the integers from 1 up to the number passed as an argument. For example, if 50 is passed as an argument, the function will return the sum of 1, 2, 3, 4, ... 50. Use recursion to calculate the sum. Demonstrate the function in a program.

#### 8. `isMember` Function

Write a recursive Boolean function named `isMember`. The function should accept two arguments: an array and a value. The function should return true if the value is found in the array, or false if the value is not found in the array. Demonstrate the function in a driver program.

#### 9. String Reverser

Write a recursive function that accepts a `string` object as its argument and prints the string in reverse order. Demonstrate the function in a driver program.

#### 10. `maxNode` Function

Add a member function named `maxNode` to the `NumberList` class discussed in this chapter. The function should return the largest value stored in the list. Use recursion in the function to traverse the list. Demonstrate the function in a driver program.

#### 11. Palindrome Detector

A palindrome is any word, phrase, or sentence that reads the same forward and backward. Here are some well-known palindromes:

Able was I, ere I saw Elba

A man, a plan, a canal, Panama

Desserts, I stressed

Kayak

Write a `bool` function that uses recursion to determine if a string argument is a palindrome. The function should return `true` if the argument reads the same forward and backward.

Demonstrate the function in a program.

## 12. Ackermann's Function

Ackermann's Function is a recursive mathematical algorithm that can be used to test how well a computer performs recursion. Write a function `A(m, n)` that solves Ackermann's Function. Use the following logic in your function:

```
If m = 0 then return n + 1
If n = 0 then return A(m-1, 1)
Otherwise, return A(m-1, A(m, n-1))
```

Test your function in a driver program that displays the following values:

```
A(0, 0) A(0, 1) A(1, 1) A(1, 2) A(1, 3) A(2, 2) A(3, 2)
```



---

# Chapter **21** Binary Trees

---

## Topics

**21.1 Definition and Applications of Binary Trees** 

**21.2 Binary Search Tree Operations** 

**21.3 Template Considerations for Binary Search Trees** 

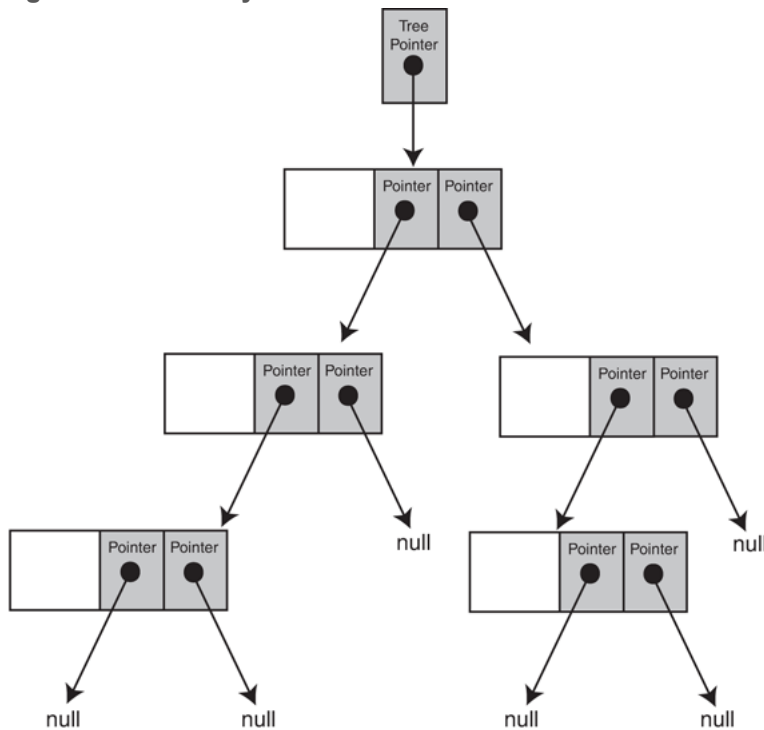
# 21.1 Definition and Applications of Binary Trees

## Concept:

A binary tree is a nonlinear linked structure in which each node may point to two other nodes, and every node but the root node has a single predecessor. Binary trees expedite the process of searching large sets of data.

A standard linked list is a linear data structure in which one node is linked to the next. A *binary tree* is a nonlinear linked structure. It is nonlinear because each node can point to two other nodes. [Figure 21-1](#) illustrates the organization of a binary tree.

Figure 21-1 A binary tree

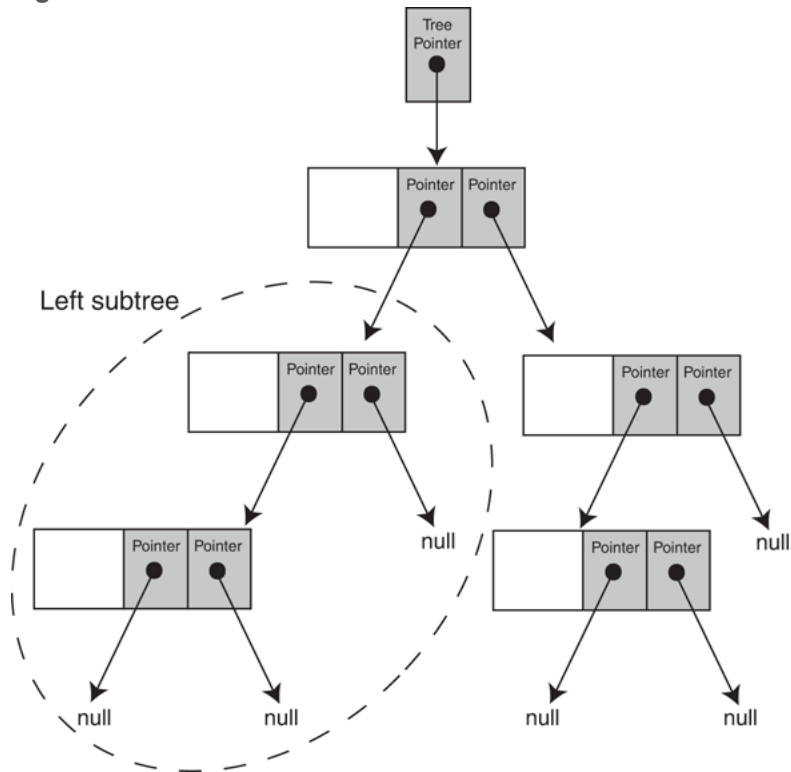


The data structure is called a tree because it resembles an upside-down tree. It is anchored at the top by a *tree pointer*, which is like the head pointer in a standard linked list. The first node in the list is called the *root node*. The root node has pointers to two other nodes, which are called *children*, or *child nodes*. Each of the children has its own set of two pointers, and can have its own children. Notice not all nodes

have two children. Some point to only one node, and some point to no other nodes. A node with no children is called a *leaf node*. All pointers that do not point to a node are set to `nullptr`.

Binary trees can be divided into *subtrees*. A subtree is an entire branch of the tree, from one particular node down. For example, [Figure 21-2](#) shows the left subtree from the root node of the tree shown in [Figure 21-1](#).

**Figure 21-2** Left subtree

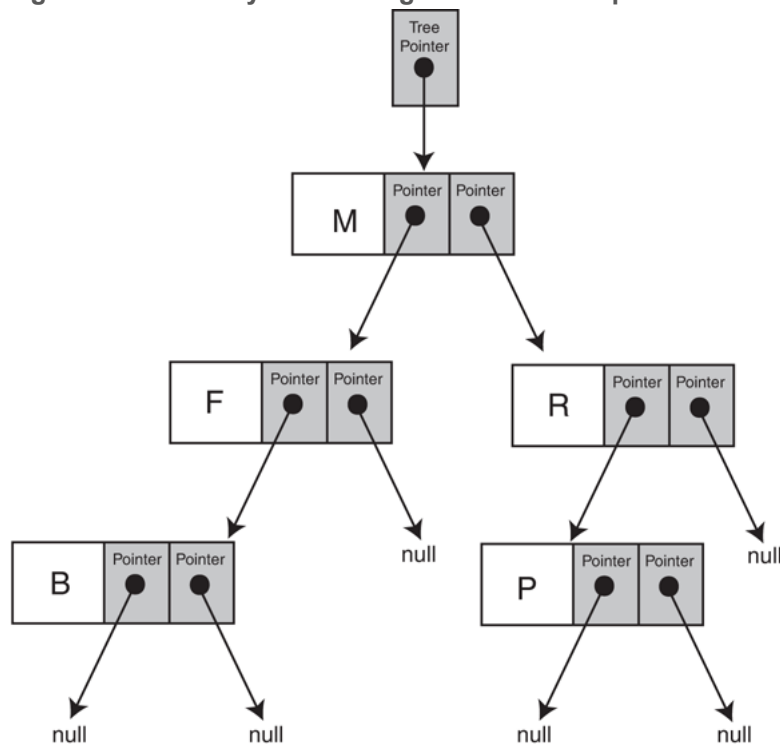


# Applications of Binary Trees

Searching any linear data structure, such as an array or a standard linked list, is slow when the structure holds a large amount of data. This is because of the sequential nature of linear data structures. Binary trees are excellent data structures for searching large amounts of data. They are commonly used in database applications to organize key values that index database records. When used to facilitate searches, a binary tree is called a *binary search tree*. Binary search trees are the primary focus of this chapter.

Data are stored in binary search trees in a way that makes a binary search simple. For example, look at [Figure 21-3](#).

**Figure 21-3 A binary tree storing letters of the alphabet**

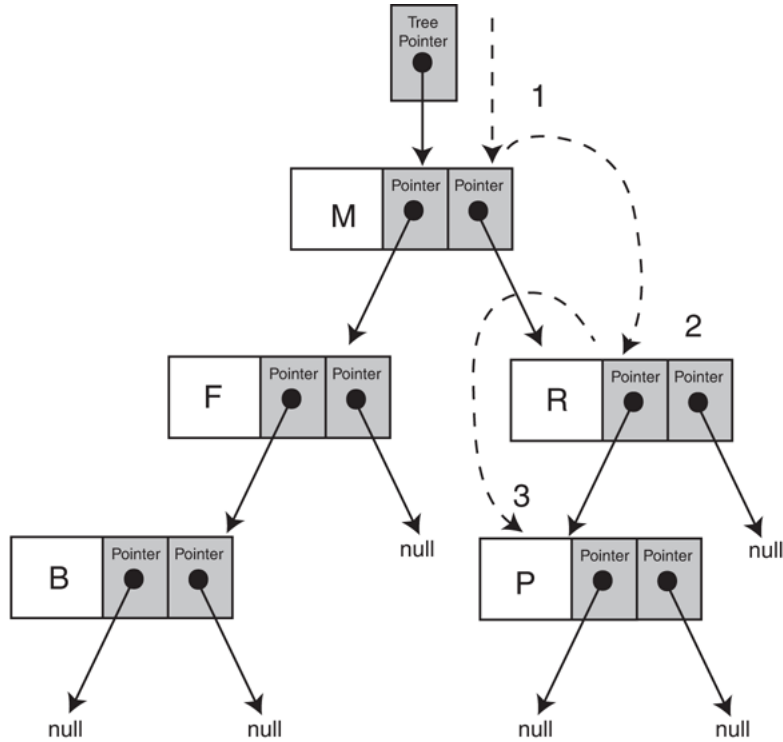


The figure depicts a binary search tree where each node stores a letter of the alphabet. Notice the root node holds the letter M. The left child of the root node holds the letter F, and the right child holds R. Values are stored in a binary search tree so a node's left child holds data whose value is less than the node's data, and the node's right child holds data whose value is greater than the node's data. This is true for all nodes in the tree that have children.

It is also true that *all* the nodes to the left of a node hold values less than the node's value. Likewise, all the nodes to the right of a node hold values that are greater than the node's data. When an application is searching a binary tree, it starts at the root node. If the root node does not hold the search value, the

application branches either to the left or right child, depending on whether the search value is less than or greater than the value at the root node. This process continues until the value is found. [Figure 21-4](#) illustrates the search pattern for finding the letter P in the binary tree shown.

**Figure 21-4 Search pattern for finding the letter P**



## Checkpoint

- 21.1 Describe the difference between a binary tree and a standard linked list.
- 21.2 What is a root node?
- 21.3 What is a child node?
- 21.4 What is a leaf node?
- 21.5 What is a subtree?
- 21.6 Why are binary trees suitable for algorithms that must search large amounts of data?

## 21.2 Binary Search Tree Operations

**Concept:**

Many operations may be performed on a binary search tree. In this section, we will discuss creating a binary search tree and inserting, finding, and deleting nodes.

In this section, you will learn some basic operations that may be performed on a binary search tree. We will study a simple class that implements a binary tree for storing integer values.

# Creating a Binary Trees

We will demonstrate the fundamental binary tree operations using a simple ADT: the `IntBinaryTree` class. The basis of our binary tree node is the following `struct` declaration:

```
struct TreeNode
{
    int value;
    TreeNode *left;
    TreeNode *right;
};
```

Each node has a `value` member for storing its integer data, as well as `left` and `right` pointers. The `struct` is implemented in the class declaration shown here:

## Contents of `IntBinaryTree.h`

```
1 // Specification file for the IntBinaryTree class
2 #ifndef INTBINARYTREE_H
3 #define INTBINARYTREE_H
4
5 class IntBinaryTree
6 {
7 private:
8     struct TreeNode
9     {
10         int value; // The value in the node
11         TreeNode *left; // Pointer to left child node
12         TreeNode *right; // Pointer to right child node
13     };
14
15     TreeNode *root; // Pointer to the root node
16
17     // Private member functions
18     void insert(TreeNode *&, TreeNode *&);
19     void destroySubTree(TreeNode *);
20     void deleteNode(int, TreeNode *&);
21     void makeDeletion(TreeNode *&);
22     void displayInOrder(TreeNode *) const;
23     void displayPreOrder(TreeNode *) const;
24     void displayPostOrder(TreeNode *) const;
25
26 public:
27     // Constructor
28     IntBinaryTree()
29         { root = nullptr; }
30
31     // Destructor
32     ~IntBinaryTree()
33         { destroySubTree(root); }
34
35     // Binary tree operations
36     void insertNode(int);
37     bool searchNode(int);
```



```
38     void remove(int);
39
40     void displayInOrder() const
41         { displayInOrder(root); }
42
43     void displayPreOrder() const
44         { displayPreOrder(root); }
45
46     void displayPostOrder() const
47         { displayPostOrder(root); }
48 };
49 #endif
```

The `root` pointer will be used as the tree pointer. Similar to the head pointer in a linked list, `root` will point to the first node in the tree, or to `nullptr` if the tree is empty. It is initialized in the constructor, which is declared inline. The destructor calls `destroySubTree`, a private member function that recursively deletes all the nodes in the tree.

# Inserting a Node



## Inserting a Node in a Binary Tree

The code to insert a node into the tree is fairly straightforward. The public member function `insertNode` is called with the number to be inserted passed as an argument. The code for the function, which is in `IntBinaryTree.cpp`, is shown here:

```
27 void IntBinaryTree::insertNode(int num)
28 {
29     TreeNode *newNode = nullptr;    // Pointer to a new node.
30
31     // Create a new node and store num in it.
32     newNode = new TreeNode;
33     newNode->value = num;
34     newNode->left = newNode->right = nullptr;
35
36     // Insert the node.
37     insert(root, newNode);
38 }
```

First, a new node is allocated in line 32 and its address stored in the local pointer variable `newNode`. The value passed as an argument is stored in the node's `value` member in line 33. The node's `left` and `right` child pointers are set to `nullptr` in line 34 because all nodes must be inserted as leaf nodes. Next, the private member function `insert` is called in line 37. Notice the `root` pointer and the `newNode` pointer are passed as arguments. The code for the `insert` function is shown here:

```

12 void IntBinaryTree::insert(TreeNode *&nodePtr, TreeNode *&newNode)
13 {
14     if (nodePtr == nullptr)
15         nodePtr = newNode; // Insert the node.
16     else if (newNode->value < nodePtr->value)
17         insert(nodePtr->left, newNode); // Search the left branch.
18     else
19         insert(nodePtr->right, newNode); // Search the right branch.
20 }

```

In general, this function takes a pointer to a subtree, and a pointer to a new node as arguments. It searches for the appropriate location in the subtree to insert the node, then makes the insertion. Notice the declaration of the first parameter, `nodePtr`:

```
TreeNode *&nodePtr
```

The `nodePtr` parameter is not simply a pointer to a `TreeNode` structure, but a *reference* to a pointer to a `TreeNode` structure. This means that any action performed on `nodePtr` is actually performed on the argument that was passed into `nodePtr`. The reason for this will be explained momentarily.

The `if` statement in line 14 determines whether `nodePtr` is set to `nullptr`:

```

if (nodePtr == nullptr)
    nodePtr = newNode; // Insert the node.

```

If `nodePtr` is set to `nullptr`, it is at the end of a branch, and the insertion point has been found. `nodePtr` is then made to point to `newNode`, which inserts `newNode` into the tree. This is why the `nodePtr` parameter is a reference. If it weren't a reference, this function would be making a copy of a node point to the new node, not the actual node in the tree.

If `nodePtr` is not set to `nullptr`, the following `else if` statement in line 16 executes:

```

else if (newNode->value < nodePtr->value)
    insert(nodePtr->left, newNode); // Search the left branch.


```

If the new node's value is less than the value pointed to by `nodePtr`, the insertion point is somewhere in the left subtree. If this is the case, the `insert` function is recursively called in line 17 with `nodePtr->left` passed as the subtree argument.

If the new node's value is not less than the value pointed to by `nodePtr`, the `else` statement in line 18 executes:

```
else
    insert(nodePtr->right, newNode); // Search the right branch.
```

The `else` statement recursively calls the `insert` function called with `nodePtr->right` passed as the subtree argument.

**Program 21-1**  demonstrates these functions.

## Program 21-1

```
1 // This program builds a binary tree with 5 nodes.
2 #include <iostream>
3 #include "IntBinaryTree.h"
4 using namespace std;
5
6 int main()
7 {
8     IntBinaryTree tree;
9
10    cout << "Inserting nodes. ";
11    tree.insertNode(5);
12    tree.insertNode(8);
13    tree.insertNode(3);
14    tree.insertNode(12);
15    tree.insertNode(9);
16    cout << "Done.\n";
17
18    return 0;
19 }
```



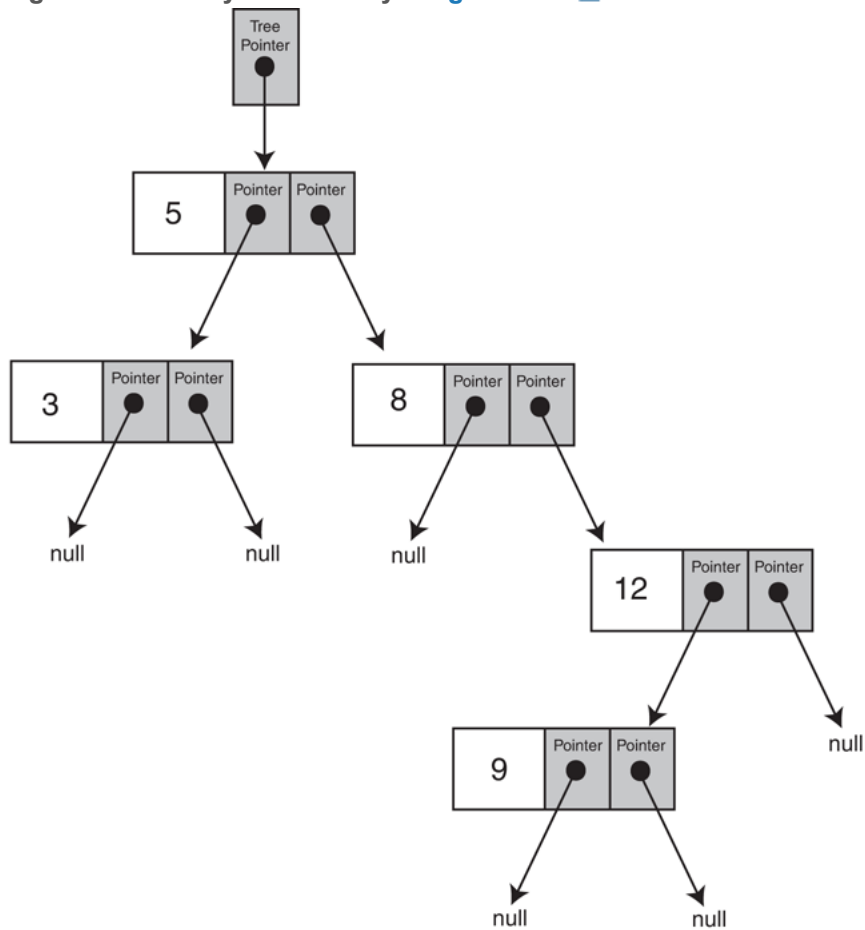
Figure 21-5  shows the structure of the binary tree built by Program 21-1 .

Figure 21-5 Binary tree built by [Program 21-1](#)



**Note:**

The shape of the tree is determined by the order in which the values are inserted. The root node in the diagram above holds the value 5 because that was the first value inserted. By stepping through the function, you can see how the other nodes came to appear in their depicted positions.



**Note:**

If the new value being inserted into the tree is equal to an existing value, the insertion algorithm inserts it to the right of the existing value.

# Traversing the Tree

There are three common methods for traversing a binary tree and processing the value of each node: *inorder*, *preorder*, and *postorder*. Each of these methods is best implemented as a recursive function. The algorithms are described as follows:

- **Inorder traversal**

1. The current node's left subtree is traversed.
2. The current node's data is processed.
3. The current node's right subtree is traversed.

- **Preorder traversal**

1. The current node's data is processed
2. The current node's left subtree is traversed.
3. The current node's right subtree is traversed.

- **Postorder traversal**

1. The current node's left subtree is traversed.
2. The current node's right subtree is traversed.
3. The current node's data is processed.

The `IntBinaryTree` class can display all the values in the tree using all three of these algorithms. The algorithms are initiated by the following inline public member functions:

```
void displayInOrder() const
{ displayInOrder(root); }
void displayPreOrder() const
{ displayPreOrder(root); }
void displayPostOrder() const
{ displayPostOrder(root); }
```

Each of the public member functions calls an overloaded recursive private member function and passes the root pointer as an argument. The recursive functions, which are very simple and straightforward, are shown here:





```

149 //*****
150 // The displayInOrder member function displays the values *
151 // in the subtree pointed to by nodePtr, via inorder traversal. *
152 //*****
153
154 void IntBinaryTree::displayInOrder(TreeNode *nodePtr) const
155 {
156     if (nodePtr)
157     {
158         displayInOrder(nodePtr->left);
159         cout << nodePtr->value << endl;
160         displayInOrder(nodePtr->right);
161     }
162 }
163
164 //*****
165 // The displayPreOrder member function displays the values *
166 // in the subtree pointed to by nodePtr, via preorder traversal. *
167 //*****
168
169 void IntBinaryTree::displayPreOrder(TreeNode *nodePtr) const
170 {
171     if (nodePtr)
172     {
173         cout << nodePtr->value << endl;
174         displayPreOrder(nodePtr->left);
175         displayPreOrder(nodePtr->right);
176     }
177 }
178
179 //*****
180 // The displayPostOrder member function displays the values *
181 // in the subtree pointed to by nodePtr, via postorder traversal. *
182 //*****
183
184 void IntBinaryTree::displayPostOrder(TreeNode *nodePtr) const
185 {
186     if (nodePtr)
187     {
188         displayPostOrder(nodePtr->left);
189         displayPostOrder(nodePtr->right);

```

```
190     cout << nodePtr->value << endl;
191 }
192 }
```

**Program 21-2** , which is a modification of **Program 21-1** , demonstrates each of the traversal methods.

## Program 21-2

```
1 // This program builds a binary tree with 5 nodes.
2 // The nodes are displayed with inorder, preorder,
3 // and postorder algorithms.
4 #include <iostream>
5 #include "IntBinaryTree.h"
6 using namespace std;
7
8 int main()
9 {
10     IntBinaryTree tree;
11
12     // Insert some nodes.
13     cout << "Inserting nodes.\n";
14     tree.insertNode(5);
15     tree.insertNode(8);
16     tree.insertNode(3);
17     tree.insertNode(12);
18     tree.insertNode(9);
19
20     // Display inorder.
21     cout << "Inorder traversal:\n";
22     tree.displayInOrder();
23
24     // Display preorder.
25     cout << "\nPreorder traversal:\n";
26     tree.displayPreOrder();
27
28     // Display postorder.
29     cout << "\nPostorder traversal:\n";
30     tree.displayPostOrder();
31     return 0;
32 }
```

## Program Output

Inserting nodes.

Inorder traversal:

3  
5  
8  
9  
12

Preorder traversal:

5  
3  
8  
12  
9


Postorder traversal:

3  
9  
12  
8  
5

# Searching the Tree

The `IntBinaryTree` class has a public member function, `searchNode`, that returns `true` if a value is found in the tree, or `false` otherwise. The function simply starts at the `root` node and traverses the tree until it finds the search value or runs out of nodes. The code is shown here:

```
63 bool IntBinaryTree::searchNode(int num)
64 {
65     TreeNode *nodePtr = root;
66
67     while (nodePtr)
68     {
69         if (nodePtr->value == num)
70             return true;
71         else if (num < nodePtr->value)
72             nodePtr = nodePtr->left;
73         else
74             nodePtr = nodePtr->right;
75     }
76     return false;
77 }
```

**Program 21-3**  demonstrates this function.

## Program 21-3

```
1 // This program builds a binary tree with 5 nodes.
2 // The SearchNode function is demonstrated.
3 #include <iostream>
4 #include "IntBinaryTree.h"
5 using namespace std;
6
7 int main()
8 {
9     IntBinaryTree tree;
10
11     // Insert some nodes in the tree.
12     cout << "Inserting nodes.\n";
13     tree.insertNode(5);
14     tree.insertNode(8);
15     tree.insertNode(3);
16     tree.insertNode(12);
17     tree.insertNode(9);
18
19     // Search for the value 3.
20     if (tree.searchNode(3))
21         cout << "3 is found in the tree.\n";
22     else
23         cout << "3 was not found in the tree.\n";
24
25     // Search for the value 100.
26     if (tree.searchNode(100))
27         cout << "100 is found in the tree.\n";
28     else
29         cout << "100 was not found in the tree.\n";
30     return 0;
31 }
```

## Program Output

Inserting nodes.

3 is found in the tree.

100 was not found in the tree.

# Deleting a Node

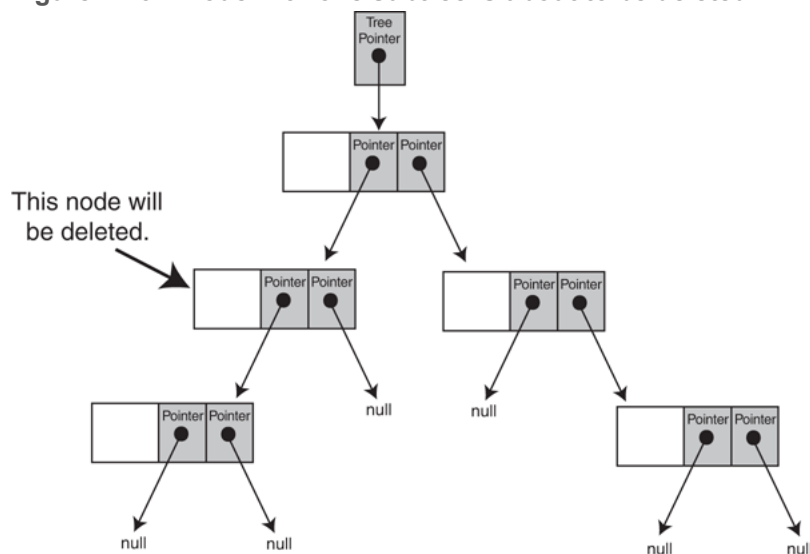
Deleting a leaf node is not difficult. We simply find its parent and set the child pointer that links to it to `nullptr`, then free the node's memory. But what if we want to delete a node that has child nodes? We must delete the node while at the same time preserving the subtrees to which the node links.



## Deleting a Node from a Binary Tree

There are two possible situations to face when deleting a nonleaf node: the node has one child, or the node has two children. [Figure 21-6](#) illustrates a tree in which we are about to delete a node with one subtree.

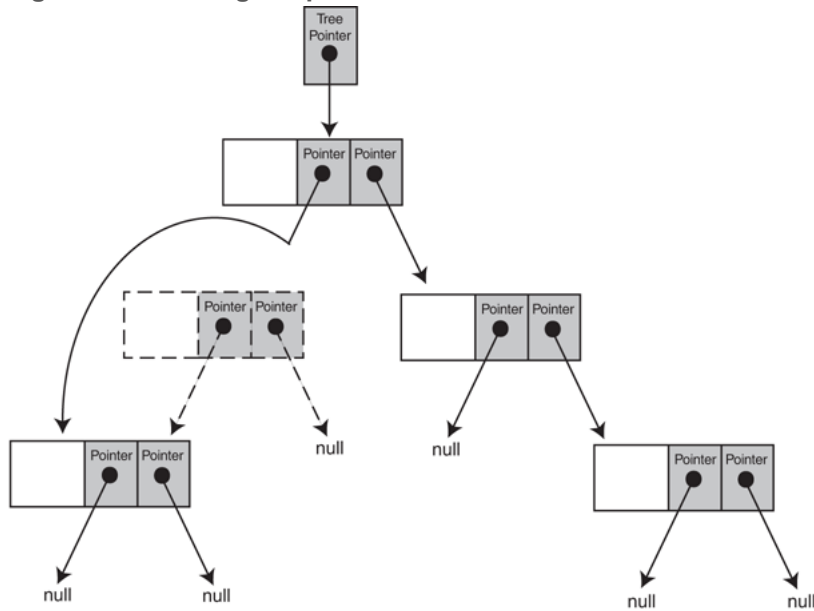
**Figure 21-6** A node with one subtree is about to be deleted



[Figure 21-7](#) shows how we will link the node's subtree with its parent.

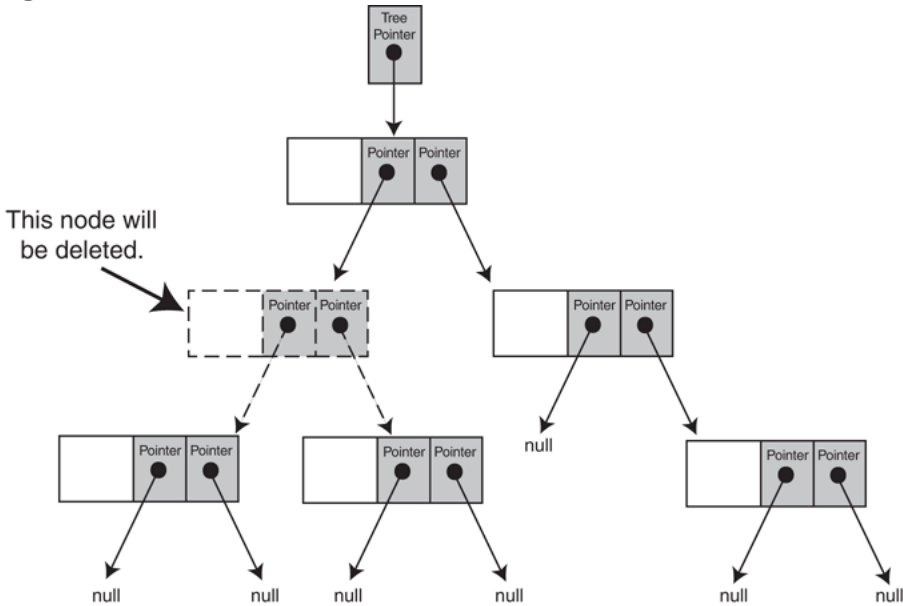


Figure 21-7 Linking the parent node with the subtree



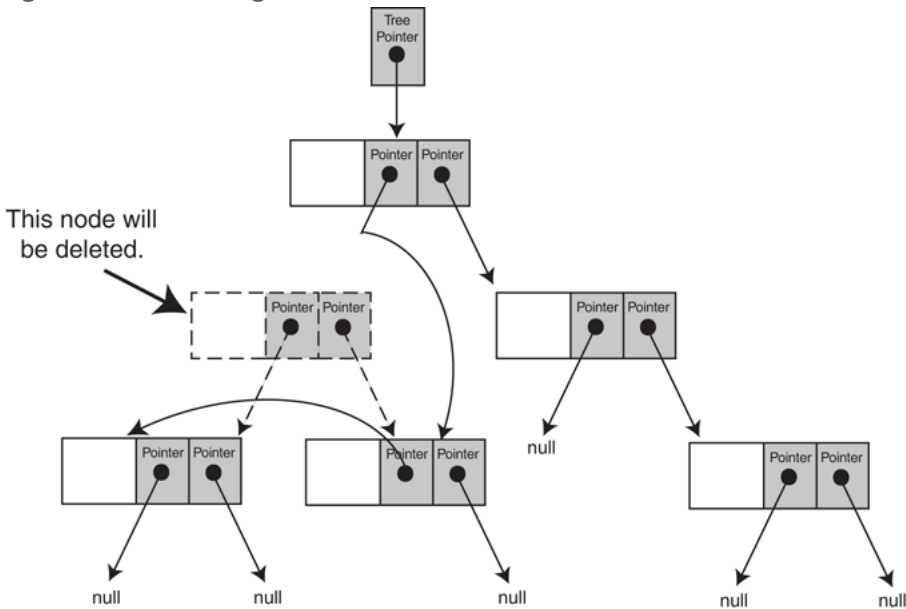
The problem is not as easily solved, however, when the node we are about to delete has two subtrees. For example, look at [Figure 21-8](#):

Figure 21-8 A node with two subtrees is about to be deleted



Obviously, we cannot attach both of the node's subtrees to its parent, so there must be an alternative solution. One way of addressing this problem is to attach the node's right subtree to the parent, then find a position in the right subtree to attach the left subtree. The result is shown in [Figure 21-9](#).

Figure 21-9 Relinking the subtrees



Now we will see how this action is implemented in code. To delete a node from the `IntBinaryTree`, call the public member `remove`. The argument passed to the function is the value of the node you wish to delete. The `remove` member function is shown here:

```
84 void IntBinaryTree::remove(int num)
85 {
86     deleteNode(num, root);
87 }
```

The `remove` member function calls the `deleteNode` member function. It passes the value of the node to delete and the `root` pointer. The `deleteNode` member function is shown here:

```
95 void IntBinaryTree::deleteNode(int num, TreeNode *&nodePtr)
96 {
97     if (num < nodePtr->value)
98         deleteNode(num, nodePtr->left);
99     else if (num > nodePtr->value)
100         deleteNode(num, nodePtr->right);
101     else
102         makeDeletion(nodePtr);
103 }
```

Notice this function's arguments are references to pointers. Like the `insert` function, the `deleteNode` function must have access to an actual pointer in the tree. You will see why momentarily.

The `deleteNode` function uses an `if/else if` statement. The first part of the statement is in lines 97 and 98:

```
if (num < nodePtr->value)
    deleteNode(num, nodePtr->left);
```

This code compares the parameter `num` with the `value` member of the node to which `nodePtr` points. If `num` is less, then the value being searched for will appear somewhere in `nodePtr`'s left subtree (if it appears in the tree at all). In this case, the `deleteNode` function is recursively called with `num` as the first argument, and `nodePtr->left` as the second argument.

If `num` is not less than `nodePtr->value`, the `else if` in lines 99 and 100 statement is executed:

```
else if (num > nodePtr->value)
    deleteNode(num, nodePtr->right);
```

If `num` is greater than `nodePtr->value`, then the value being searched for will appear somewhere in `nodePtr`'s right subtree (if it appears in the tree at all). So, the `deleteNode` function is recursively called with `num` as the first argument, and `nodePtr->right` as the second argument.

If `num` is equal to `nodePtr->value`, then neither of the `if` statements will find a true condition. In this case, `nodePtr` points to the node that is to be deleted, and the trailing `else` in lines 101 and 102 will execute:


```
else
    makeDeletion(nodePtr);
```

The trailing `else` statement calls the `makeDeletion` function and passes `nodePtr` as its argument. The `makeDeletion` function actually deletes the node from the tree and must reattach the deleted node's subtrees as shown in [Figure 21-9](#). Therefore, it must have access to the actual pointer, in the binary tree, to the node that is being deleted (not just a copy of the pointer). This is why the `nodePtr` parameter in the `deleteNode` function is a reference. It must pass to `makeDeletion` the actual pointer, in the binary tree, to the node that is to be deleted. The `makeDeletion` function's code is as follows:

```

112 void IntBinaryTree::makeDeletion(TreeNode *&nodePtr)
113 {
114     // Define a temporary pointer to use in reattaching
115     // the left subtree.
116     TreeNode *tempNodePtr = nullptr;
117
118     if (nodePtr == nullptr)
119         cout << "Cannot delete empty node.\n";
120     else if (nodePtr->right == nullptr)
121     {
122         tempNodePtr = nodePtr;
123         nodePtr = nodePtr->left; // Reattach the left child.
124         delete tempNodePtr;
125     }
126     else if (nodePtr->left == nullptr)
127     {
128         tempNodePtr = nodePtr;
129         nodePtr = nodePtr->right; // Reattach the right child.
130         delete tempNodePtr;
131     }
132     // If the node has two children.
133     else
134     {
135         // Move one node to the right.
136         tempNodePtr = nodePtr->right;
137         // Go to the end left node.
138         while (tempNodePtr->left)
139             tempNodePtr = tempNodePtr->left;
140         // Reattach the left subtree.
141         tempNodePtr->left = nodePtr->left;
142         tempNodePtr = nodePtr;
143         // Reattach the right subtree.
144         nodePtr = nodePtr->right;
145         delete tempNodePtr;
146     }
147 }

```

Program 21-4  demonstrates these functions.

## Program 21-4

```
1 // This program builds a binary tree with 5 nodes.
2 // The deleteNode function is used to remove two of them.
3 #include <iostream>
4 #include "IntBinaryTree.h"
5 using namespace std;
6
7 int main()
8 {
9     IntBinaryTree tree;
10
11     // Insert some values into the tree.
12     cout << "Inserting nodes.\n";
13     tree.insertNode(5);
14     tree.insertNode(8);
15     tree.insertNode(3);
16     tree.insertNode(12);
17     tree.insertNode(9);
18
19     // Display the values.
20     cout << "Here are the values in the tree:\n";
21     tree.displayInOrder();
22
23     // Delete the value 8.
24     cout << "Deleting 8...\n";
25     tree.remove(8);
26
27     // Delete the value 12.
28     cout << "Deleting 12...\n";
29     tree.remove(12);
30
31     // Display the values.
32     cout << "Now, here are the nodes:\n";
33     tree.displayInOrder();
34     return 0;
35 }
```

## Program Output

```
Inserting nodes.  
Here are the values in the tree:  
3  
5  
8  
9  
12  
Deleting 8...  
Deleting 12...  
Now, here are the nodes:  
3  
5  
9
```

For your reference, the entire contents of the `IntBinaryTree.cpp` file are shown below:

## Contents of `IntBinaryTree.cpp`

```
1 // Implementation file for the IntBinaryTree class
2 #include <iostream>
3 #include "IntBinaryTree.h"
4 using namespace std;
5
6 //*****
7 // insert accepts a TreeNode pointer and a pointer to a node. *
8 // The function inserts the node into the tree pointed to by *
9 // the TreeNode pointer. This function is called recursively. *
10 //*****
11
12 void IntBinaryTree::insert(TreeNode *&nodePtr, TreeNode *&newNode)
13 {
14     if (nodePtr == nullptr)
15         nodePtr = newNode; // Insert the node.
16     else if (newNode->value < nodePtr->value)
17         insert(nodePtr->left, newNode); // Search the left branch.
18     else
19         insert(nodePtr->right, newNode); // Search the right branch.
20 }
21
22 //*****
23 // insertNode creates a new node to hold num as its value, *
24 // and passes it to the insert function. *
25 //*****
26
27 void IntBinaryTree::insertNode(int num)
28 {
29     TreeNode *newNode = nullptr; // Pointer to a new node.
30
31     // Create a new node and store num in it.
32     newNode = new TreeNode;
33     newNode->value = num;
34     newNode->left = newNode->right = nullptr;
35
36     // Insert the node.
37     insert(root, newNode);
```

```

38 }
39
40 //*****
41 // destroySubTree is called by the destructor. It *
42 // deletes all nodes in the tree. *
43 //*****
44
45 void IntBinaryTree::destroySubTree(TreeNode *nodePtr)
46 {
47     if (nodePtr)
48     {
49         if (nodePtr->left)
50             destroySubTree(nodePtr->left);
51         if (nodePtr->right)
52             destroySubTree(nodePtr->right);
53         delete nodePtr;
54     }
55 }
56
57 //*****
58 // searchNode determines whether a value is present in *
59 // the tree. If so, the function returns true. *
60 // Otherwise, it returns false. *
61 //*****
62
63 bool IntBinaryTree::searchNode(int num)
64 {
65     TreeNode *nodePtr = root;
66
67     while (nodePtr)
68     {
69         if (nodePtr->value == num)
70             return true;
71         else if (num < nodePtr->value)
72             nodePtr = nodePtr->left;
73         else
74             nodePtr = nodePtr->right;
75     }
76     return false;
77 }
78

```



```

79 //*****
80 // remove calls deleteNode to delete the *
81 // node whose value member is the same as num. *
82 //*****
83
84 void IntBinaryTree::remove(int num)
85 {
86     deleteNode(num, root);
87 }
88
89
90 //*****
91 // deleteNode deletes the node whose value *
92 // member is the same as num. *
93 //*****
94
95 void IntBinaryTree::deleteNode(int num, TreeNode *&nodePtr)
96 {
97     if (num < nodePtr->value)
98         deleteNode(num, nodePtr->left);
99     else if (num > nodePtr->value)
100         deleteNode(num, nodePtr->right);
101     else
102         makeDeletion(nodePtr);
103 }
104
105
106 //*****
107 // makeDeletion takes a reference to a pointer to the node *
108 // that is to be deleted. The node is removed and the *
109 // branches of the tree below the node are reattached. *
110 //*****
111
112 void IntBinaryTree::makeDeletion(TreeNode *&nodePtr)
113 {
114     // Define a temporary pointer to use in reattaching
115     // the left subtree.
116     TreeNode *tempNodePtr = nullptr;
117
118     if (nodePtr == nullptr)
119         cout << "Cannot delete empty node.\n";

```

```

120     else if (nodePtr->right == nullptr)
121     {
122         tempNodePtr = nodePtr;
123         nodePtr = nodePtr->left; // Reattach the left child.
124         delete tempNodePtr;
125     }
126     else if (nodePtr->left == nullptr)
127     {
128         tempNodePtr = nodePtr;
129         nodePtr = nodePtr->right; // Reattach the right child.
130         delete tempNodePtr;
131     }
132     // If the node has two children.
133     else
134     {
135         // Move one node to the right.
136         tempNodePtr = nodePtr->right;
137         // Go to the end left node.
138         while (tempNodePtr->left)
139             tempNodePtr = tempNodePtr->left;
140         // Reattach the left subtree.
141         tempNodePtr->left = nodePtr->left;
142         tempNodePtr = nodePtr;
143         // Reattach the right subtree.
144         nodePtr = nodePtr->right;
145         delete tempNodePtr;
146     }
147 }
148
149 //*****
150 // The displayInOrder member function displays the values *
151 // in the subtree pointed to by nodePtr, via inorder traversal. *
152 //*****
153
154 void IntBinaryTree::displayInOrder(TreeNode *nodePtr) const
155 {
156     if (nodePtr)
157     {
158         displayInOrder(nodePtr->left);
159         cout << nodePtr->value << endl;
160         displayInOrder(nodePtr->right);

```

```
161     }
162 }
163
164 //*****
165 // The displayPreOrder member function displays the values *
166 // in the subtree pointed to by nodePtr, via preorder traversal. *
167 //*****
168
169 void IntBinaryTree::displayPreOrder(TreeNode *nodePtr) const
170 {
171     if (nodePtr)
172     {
173         cout << nodePtr->value << endl;
174         displayPreOrder(nodePtr->left);
175         displayPreOrder(nodePtr->right);
176     }
177 }
178
179 //*****
180 // The displayPostOrder member function displays the values *
181 // in the subtree pointed to by nodePtr, via postorder traversal. *
182 //*****
183
184 void IntBinaryTree::displayPostOrder(TreeNode *nodePtr) const
185 {
186     if (nodePtr)
187     {
188         displayPostOrder(nodePtr->left);
189         displayPostOrder(nodePtr->right);
190         cout << nodePtr->value << endl;
191     }
192 }
```

 **Checkpoint**

- 21.7 Describe the sequence of events in an inorder traversal.
- 21.8 Describe the sequence of events in a preorder traversal.
- 21.9 Describe the sequence of events in a postorder traversal.
- 21.10 Describe the steps taken in deleting a leaf node.
- 21.11 Describe the steps taken in deleting a node with one child.
- 21.12 Describe the steps taken in deleting a node with two children.


## 21.3 Template Considerations for Binary Search Trees

### Concept:

Binary search trees may be implemented as templates, but any data types used with them must support the `<`, `>`, and `==` operators.

When designing a binary tree template, remember any data types stored in the binary tree must support the `<`, `>`, and `==` operators. If you use the tree to store class objects, these operators must be overridden.

The following code shows an example of a binary tree template.

**Program 21-5**  demonstrates the template. It creates a binary tree that can hold strings, then prompts the user to enter a series of names that are inserted into the tree. The program then displays the contents of the tree using inorder traversal.

## Contents of `BinaryTree.h`

```
1  #ifndef BINARYTREE_H
2  #define BINARYTREE_H
3  #include <iostream>
4  using namespace std;
5
6  // BinaryTree template
7  template <class T>
8  class BinaryTree
9  {
10 private:
11     struct TreeNode
12     {
13         T value;           // The value in the
node
14         TreeNode *left;   // Pointer to left
child node
15         TreeNode *right;  // Pointer to right
child node
16     };
17
18     TreeNode *root; // Pointer to the root
node
19
```

```
20     // Private member functions
21     void insert(TreeNode *&, TreeNode *&);
22     void destroySubTree(TreeNode *);
23     void deleteNode(T, TreeNode *&);
24     void makeDeletion(TreeNode *&);
25     void displayInOrder(TreeNode *) const;
26     void displayPreOrder(TreeNode *) const;
27     void displayPostOrder(TreeNode *) const;
28
29 public:
30     // Constructor
31     BinaryTree()
32         { root = nullptr; }
33
34     // Destructor
35     ~BinaryTree()
36         { destroySubTree(root); }
37
38     // Binary tree operations
39     void insertNode(T);
40     bool searchNode(T);
41     void remove(T);
42
43     void displayInOrder() const
44         { displayInOrder(root); }
45
46     void displayPreOrder() const
```

```

47         { displayPreOrder(root); }
48
49     void displayPostOrder() const
50         { displayPostOrder(root); }
51     };
52
53
54 //*****
55 // insert accepts a TreeNode pointer and a
56 // pointer to a node. *
57 // The function inserts the node into the
58 // tree pointed to by *
59 // the TreeNode pointer. This function is
60 // called recursively. *
61
62 //*****
63
64 template <class T>
65 void BinaryTree<T>::insert(TreeNode
66 *&nodePtr, TreeNode *&newNode)
67 {
68     if (nodePtr == nullptr)
69         nodePtr = newNode; //
70     Insert the node
71     else if (newNode->value < nodePtr->value)
72         insert(nodePtr->left, newNode); //

```



```

Search the left branch
65     else
66         insert(nodePtr->right, newNode); //
Search the right branch
67     }
68
69
//*****
*****
70 // insertNode creates a new node to hold num
as its value, *
71 // and passes it to the insert function.
*
72
//*****
*****
73 template <class T>
74 void BinaryTree<T>::insertNode(T item)
75 {
76     TreeNode *newNode = nullptr; // Pointer
to a new node
77
78     // Create a new node and store num in it.
79     newNode = new TreeNode;
80     newNode->value = item;
81     newNode->left = newNode->right = nullptr;
82

```

```

83     // Insert the node.
84     insert(root, newNode);
85 }
86
87
//*****
***
88 // destroySubTree is called by the
destructor. It *
89 // deletes all nodes in the tree.
*
90
//*****
***
91 template <class T>
92 void BinaryTree<T>::destroySubTree(TreeNode
*nodePtr)
93 {
94     if (nodePtr)
95     {
96         if (nodePtr->left)
97             destroySubTree(nodePtr->left);
98         if (nodePtr->right)
99             destroySubTree(nodePtr->right);
100        delete nodePtr;
101    }
102 }

```

```

103
104
//*****
***
105 // searchNode determines if a value is
present in *
106 // the tree. If so, the function returns
true. *
107 // Otherwise, it returns false.
*
108
//*****
***
109 template <class T>
110 bool BinaryTree<T>::searchNode(T item)
111 {
112     TreeNode *nodePtr = root;
113
114     while (nodePtr)
115     {
116         if (nodePtr->value == item)
117             return true;
118         else if (item < nodePtr->value)
119             nodePtr = nodePtr->left;
120         else
121             nodePtr = nodePtr->right;
122     }

```

```

123     return false;
124 }
125
126
//*****
127 // remove calls deleteNode to delete the
*
128 // node whose value member is the same as
num. *
129
//*****
130 template <class T>
131 void BinaryTree<T>::remove(T item)
132 {
133     deleteNode(item, root);
134 }
135
136
//*****
137 // deleteNode deletes the node whose value *
138 // member is the same as num. *
139
//*****
140 template <class T>
141 void BinaryTree<T>::deleteNode(T item,
TreeNode *&nodePtr)
142 {

```

```

143     if (item < nodePtr->value)
144         deleteNode(item, nodePtr->left);
145     else if (item > nodePtr->value)
146         deleteNode(item, nodePtr->right);
147     else
148         makeDeletion(nodePtr);
149 }
150
151
152 //*****
153 // makeDeletion takes a reference to a
154 // pointer to the node *
155 // that is to be deleted. The node is removed
156 // and the *
157 // branches of the tree below the node are
158 // reattached. *
159
160 //*****
161
162 template <class T>
163 void BinaryTree<T>::makeDeletion(TreeNode
164 *&nodePtr)
165 {
166     // Define a temporary pointer to use in
167     // reattaching
168     // the left subtree.

```

```
161     TreeNode *tempNodePtr = nullptr;
162
163     if (nodePtr == nullptr)
164         cout << "Cannot delete empty
node.\n";
165     else if (nodePtr->right == nullptr)
166     {
167         tempNodePtr = nodePtr;
168         nodePtr = nodePtr->left; // Reattach
the left child
169         delete tempNodePtr;
170     }
171     else if (nodePtr->left == nullptr)
172     {
173         tempNodePtr = nodePtr;
174         nodePtr = nodePtr->right; //
Reattach the right child
175         delete tempNodePtr;
176     }
177     // If the node has two children.
178     else
179     {
180         // Move one node to the right.
181         tempNodePtr = nodePtr->right;
182         // Go to the end left node.
183         while (tempNodePtr->left)
184             tempNodePtr = tempNodePtr->left;
```

```

185         // Reattach the left subtree.
186         tempNodePtr->left = nodePtr->left;
187         tempNodePtr = nodePtr;
188         // Reattach the right subtree.
189         nodePtr = nodePtr->right;
190         delete tempNodePtr;
191     }
192 }
193
194
195 //*****
196 // The displayInOrder member function
197 // displays the values *
198 // in the subtree pointed to by nodePtr, via
199 // inorder traversal. *
200 //*****
201
202 template <class T>
203 void BinaryTree<T>::displayInOrder(TreeNode
204 *nodePtr) const
205 {
206     if (nodePtr)
207     {
208         displayInOrder(nodePtr->left);
209         cout << nodePtr->value << endl;

```

```

205     displayInOrder (nodePtr->right);
206 }
207 }
208
209
//*****
*****
210 // The displayPreOrder member function
displays the values *
211 // in the subtree pointed to by nodePtr, via
preorder traversal. *
212
//*****
*****
213 template <class T>
214 void BinaryTree<T>::displayPreOrder (TreeNode
*nodePtr) const
215 {
216     if (nodePtr)
217     {
218         cout << nodePtr->value << endl;
219         displayPreOrder (nodePtr->left);
220         displayPreOrder (nodePtr->right);
221     }
222 }
223
224

```



```
224 //*****
225 // The displayPostOrder member function
226 // displays the values *
227 // in the subtree pointed to by nodePtr, via
228 // postorder traversal.*
229 //*****
230 *****
231 template <class T>
232 void BinaryTree<T>::displayPostOrder (TreeNode
233 *nodePtr) const
234 {
235     if (nodePtr)
236     {
237         displayPostOrder (nodePtr->left);
238         displayPostOrder (nodePtr->right);
239         cout << nodePtr->value << endl;
240     }
241 }
242 #endif
```

## Program 21-5

```
1 // This program demonstrates the BinaryTree
class template.
2 // It builds a binary tree with 5 nodes.
3 #include <iostream>
4 #include "BinaryTree.h"
5 using namespace std;
6
7 const int NUM_NODES = 5;
8
9 int main()
10 {
11     string name;
12
13     // Create the binary tree.
14     BinaryTree<string> tree;
15
16     // Insert some names.
17     for (int count = 0; count < NUM_NODES;
count++)
18     {
19         cout << "Enter a name: ";
20         getline(cin, name);
21         tree.insertNode(name);
```

```
22     }  
23  
24     // Display the values.  
25     cout << "\nHere are the values in the  
tree:\n";  
26     tree.displayInOrder();  
27     return 0;  
28 }
```

### Program Output with Example Input Shown in Bold

```
Enter a name: David Enter  
Enter a name: Geri Enter  
Enter a name: Chris Enter  
Enter a name: Samantha Enter  
Enter a name: Anthony Enter  
  
Here are the values in the tree:  
Anthony  
Chris  
David  
Geri  
Samantha
```

# Review Questions and Exercises

## Short Answer

1. Each node in a binary tree may point to how many other nodes?
2. How many predecessors may each node other than the root node have?
3. What is a leaf node?
4. What is a subtree?
5. What initially determines the shape of a binary tree?
6. What are the three methods of traversing a binary tree? What is the difference between these methods?

# Fill-in-the-Blank

7. The first node in a binary tree is called the \_\_\_\_\_.
8. A binary tree node's left and right pointers point to the node's \_\_\_\_\_.
9. A node with no children is called a(n) \_\_\_\_\_.
10. A(n) \_\_\_\_\_ is an entire branch of the tree, from one particular node down.
11. The three common types of traversal with a binary tree are \_\_\_\_\_, \_\_\_\_\_, and \_\_\_\_\_.

# Algorithm Workbench

12. Write a pseudocode algorithm for inserting a node in a tree.
13. Write a pseudocode algorithm for the inorder traversal.
14. Write a pseudocode algorithm for the preorder traversal.
15. Write a pseudocode algorithm for the postorder traversal.
16. Write a pseudocode algorithm for searching a tree for a specified value.
17. Suppose the following values are inserted into a binary tree, in the order given:  
12, 7, 9, 10, 22, 24, 30, 18, 3, 14, 20  
Draw a diagram of the resulting binary tree.
18. How would the values in the tree you sketched for Question 17 be displayed in an inorder traversal?
19. How would the values in the tree you sketched for Question 17 be displayed in a preorder traversal?
20. How would the values in the tree you sketched for Question 17 be displayed in a postorder traversal?

# True or False

21. T F Each node in a binary tree must have at least two children.
22. T F When a node is inserted into a tree, it must be inserted as a leaf node.
23. T F Values stored in the current node's left subtree are less than the value stored in the current node.
24. T F The shape of a binary tree is determined by the order in which values are inserted.
25. T F In inorder traversal, the node's data is processed first, then the left and right nodes are visited.

# Programming Challenges

## 1. Binary Tree Template

Write your own version of a class template that will create a binary tree that can hold values of any data type. Demonstrate the class with a driver program.

## 2. Node Counter

Write a member function, for either the template you designed in Programming Challenge 1 or the `IntBinaryTree` class, that counts and returns the number of nodes in the tree. Demonstrate the function in a driver program.



## Solving the Node Counter Problem

## 3. Leaf Counter

Write a member function, for either the template you designed in Programming Challenge 1 or the `IntBinaryTree` class, that counts and returns the number of leaf nodes in the tree.

Demonstrate the function in a driver program.

## 4. Tree Height

Write a member function, for either the template you designed in Programming Challenge 1 or the `IntBinaryTree` class, that returns the height of the tree. The height of the tree is the number of levels it contains. For example, the tree shown in [Figure 21-10](#) has three levels.





# Appendix A The ASCII Character Set

# Appendix B Operator Precedence and Associativity

The operators are shown in order of precedence, from highest to lowest.

# C++ Quick Reference

### Commonly Used C++ Data Types

| Data Type              | Description                          |
|------------------------|--------------------------------------|
| char                   | Character                            |
| unsigned char          | Unsigned Character                   |
| int                    | Integer                              |
| short int              | Short integer                        |
| unsigned short int     | Unsigned short integer               |
| unsigned int           | Unsigned integer                     |
| long int               | Long integer                         |
| unsigned long int      | Unsigned long integer                |
| long long int          | Very large integer                   |
| unsigned long long int | Very large unsigned integer          |
| float                  | Single precision floating point      |
| double                 | double precision floating point      |
| long double            | Long double precision floating point |

### Forms of the if Statement

| Form                                                                                                           | Example                                                       |
|----------------------------------------------------------------------------------------------------------------|---------------------------------------------------------------|
| <b>Simple if</b><br>if (expression)<br>statement;                                                              | if (x < y)<br>x++;                                            |
| <b>if/else</b><br>if (expression)<br>statement;<br>else<br>statement;                                          | if (x < y)<br>x++;<br>else<br>x--;                            |
| <b>if/else if</b><br>if (expression)<br>statement;<br>else if (expression)<br>statement;<br>else<br>statement; | if (x < y)<br>x++;<br>else if (x < z)<br>x--;<br>else<br>y++; |

To conditionally-execute more than one statement, enclose the statements in braces:

| Form                                                  | Example                                    |
|-------------------------------------------------------|--------------------------------------------|
| if (expression)<br>{<br>statement;<br>statement;<br>} | if (x < y)<br>{<br>x++;<br>cout << x;<br>} |

### Web Sites

For the *Starting Out with C++ Companion* website  
[www.pearsonhighered.com/gaddis](http://www.pearsonhighered.com/gaddis)  
For Pearson Higher Ed Computer Science  
[www.pearsonhighered.com/cs](http://www.pearsonhighered.com/cs)

### Commonly Used Operators

#### Assignment Operators

|    |                                    |
|----|------------------------------------|
| =  | Assignment                         |
| += | Combined addition/assignment       |
| -= | Combined subtraction/assignment    |
| *= | Combined multiplication/assignment |
| /= | Combined division/assignment       |
| %= | Combined modulus/assignment        |

#### Arithmetic Operators

|   |                     |
|---|---------------------|
| + | Addition            |
| - | Subtraction         |
| * | Multiplication      |
| / | Division            |
| % | Modulus (remainder) |

#### Relational Operators

|    |                          |
|----|--------------------------|
| <  | Less than                |
| <= | Less than or equal to    |
| >  | Greater than             |
| >= | Greater than or equal to |
| == | Equal to                 |
| != | Not equal to             |

#### Logical Operators

|    |     |
|----|-----|
| && | AND |
|    | OR  |
| !  | NOT |

#### Increment/Decrement

|    |           |
|----|-----------|
| ++ | Increment |
| -- | Decrement |

### Conditional Operator ?:

#### Form:

expression ? expression : expression

#### Example:

```
x = a < b ? a : b;
```

The statement above works like:

```
if (a < b)  
    x = a;  
else  
    x = b;
```

### The while Loop

#### Form:

```
while (expression)  
    statement;
```

#### Example:

```
while (x < 100)  
    cout << x++ << endl;  
  
while (expression) while (x < 100)  
{  
    statement;  
    statement;  
    cout << x << endl;  
    x++;  
}
```

### The do-while Loop

#### Form:

```
do  
    statement;  
while (expression);
```

#### Example:

```
do  
    cout << x++ << endl;  
while (x < 100);  
  
do  
{  
    statement;  
    statement;  
    cout << x << endl;  
    x++;  
} while (expression); } while (x < 100);
```

### The for Loop

#### Form:

```
for (initialization; test; update)
    statement;

for (initialization; test; update)
{
    statement;
    statement;
}
```

#### Example:

```
for (count = 0; count < 10; count++)
    cout << count << endl;

for (count = 0; count < 10; count++)
{
    cout << "The value of count is ";
    cout << count << endl;
}
```

### The switch/case Construct

#### Form:

```
switch (integer-expression)
{
    case integer-constant:
        statement(s);
        break;
    case integer-constant:
        statement(s);
        break;
    default:
        statement;
}
```

#### Example:

```
switch (choice)
{
    case 0 :
        cout << "You selected 0.\n";
        break;
    case 1 :
        cout << "You selected 1.\n";
        break;
    default :
        cout << "You did not select 0 or 1.\n";
}
```

### Using cout

Requires <iostream> header file.

#### Commonly used stream manipulators

| Name         | Description                                       |
|--------------|---------------------------------------------------|
| endl         | Advances output to the beginning of the next line |
| fixed        | Sets fixed point notation                         |
| left         | Sets left justification                           |
| right        | Sets right justification                          |
| setprecision | Sets the number of significant digits             |
| setw         | Sets field width                                  |
| showpoint    | Forces decimal point & trailing zeros to display  |

#### Example:

```
cout << setprecision(2) << fixed
      << left << x << endl;
```

#### Member functions for output formatting

| Name      | Description                           |
|-----------|---------------------------------------|
| precision | Sets the number of significant digits |
| setf      | Sets one or more ios flags            |
| unsetf    | Clears one or more ios flags          |
| width     | Sets field width                      |

#### Example:

```
cout.precision(2);
```

### Using cin

Requires <iostream> header file

#### Commonly used stream manipulators

| Name | Description      |
|------|------------------|
| setw | Sets field width |

#### Member functions for specialized input

| Name    | Description                        |
|---------|------------------------------------|
| getline | Reads a line input as a C-string   |
| get     | Reads a character                  |
| ignore  | Ignores the last character entered |
| width   | Sets field width                   |

### Some Commonly Used Library Functions

| Name                                           | Description                                           |
|------------------------------------------------|-------------------------------------------------------|
| <i>(The following require &lt;string&gt;)</i>  |                                                       |
| stod                                           | Converts a string to a double                         |
| stoi                                           | Converts a string to an int                           |
| stol                                           | Converts a string to a long int                       |
| <i>(The following require &lt;cstdlib&gt;)</i> |                                                       |
| rand                                           | Generates a pseudo-random number                      |
| srand                                          | Sets seed value for random numbers                    |
| <i>(The following require &lt;cctype&gt;)</i>  |                                                       |
| islower                                        | Returns true if char argument is lowercase            |
| isupper                                        | Returns true if char argument is uppercase            |
| tolower                                        | Returns the lowercase equivalent of the char argument |
| toupper                                        | Returns the uppercase equivalent of the char argument |
| <i>(The following require &lt;cmath&gt;)</i>   |                                                       |
| pow                                            | Raises a number to a power                            |
| sqrt                                           | Returns square root of a number                       |
| <i>(The following require &lt;cstring&gt;)</i> |                                                       |
| strcat                                         | Appends a C-string to another C-string                |
| strcpy                                         | Copies a C-string                                     |
| strlen                                         | Returns the length of a C-string                      |

# Index

# Symbols

- `-` (negation operator), [63](#), [93](#), [94](#)
- `-` (subtraction operator), [64](#)
- `--`, [231–235](#)
- `--=`, [107–109](#)
- `->` (object pointer), [739](#)
- `->` (structure pointer), [637–638](#), [639–641](#)
- `!`, [184](#), [189–190](#)
- `!=`, [152–154](#)
- `" "`, [30](#)
- `#`, [30](#)
- `%`, [64](#)
- `%=`, [107–109](#)
- `&` (address operator), [503–505](#)
- `&` (reference variables), [355](#)
- `&&`, [184–186](#), [190](#)
- `( )`, [30](#)
- `*` (indirection operator), [509](#)
- `*` (multiplication operator), [64](#)
- `*` (pointer variable declaration), [640–641](#)
- `*=`, [107–109](#)
- `.` (dot operator), [618](#), [732](#)



- `/`, **64**
- `/* */`, **72**
- `//`, **30, 72**
- `/=`, **107–109**
- `::`, **730, 766**
- `;`, **30**
- `?:`, **201**
- `\\`, **35**
- `\'`, **35**
- `\"`, **35**
- `\a`, **35**
- `\b`, **35**
- `\n`, **35**
- `\r`, **35**
- `\t`, **35**
- `{`, **30, 166, 240–241**
- `||`, **184, 186–189, 190**
- `}`, **30, 166, 240–241**
- `~` (destructor), **767**
- `+`, **64, 596**
- `++`, **231–235**
- `+=`, **107–109, 596**
- `<`, **152–154**
- `<>`, **30**
- `<<` (stream insertion), **32, 274**
- `<=`, **152–154**

- `=` (assignment operator), [39](#), [60](#), [163–164](#)
- `==`, [152–154](#), [163–164](#), [241](#)
- `>`, [152–154](#)
- `>>` (stream extraction operator), [86](#), [596](#)
- `[]` (array subscript operator), [435](#), [437–439](#), [1043–1044](#)

# A

- abstract base classes, **963–967**
- abstract data type (ADT) definition, **1165–1166**
  - and structures, **613–615**
- abstraction, **613**
- accessors, **730**
- access specifiers
  - base class, **936–940**
  - in class declarations, **726**
- accumulator, **261**
- actual argument, **317**
- actual parameters, **317**
- adapter classes, containers, **1030–1031**
- addition operator (+), **614**
- address, memory, **6**
- address operator (&), **503–505**
- ADT, see **abstract data type**
- aggregate classes, member initialization list usage with, **870**
- aggregation, **866–871**
  - “has a” relationship, **868**
  - in UML diagrams, **870–871**
- algebraic expressions, **94–96**
- algorithms, **8**, **1029**, **1086**
  - categories of, **1086–1087**
  - exhaustive, **1250–1253**

- factorial, **1228–1231**
- for permutations detection, **1090–1092**
- plugging functions into, **1092–1094**
- QuickSort, **1246–1249**
- search, **463–469**, **1087–1090**
- selection sort, **482–486**
- sorting, **476–486**, **1087–1090**
- STL, to perform set operations, **1094–1103**
- ALU (arithmetic and logic unit), **5**
- American Standard Code for Information Interchange (ASCII), **50**
- anonymous enumerated type, **645**
- `append` member function, `string` class, **598**
- application software, **7–8**
- arguments, **95–96**, **317–321**
  - actual, **317**
  - arrays as, **413–423**
  - formal, **317**
  - passing, with pointers, **526–527**, **588–590**
  - structures as, **631–633**
- arithmetic and logic unit (ALU), **5**
- arithmetic assignment operators, **107**
- arithmetic expressions, **91–100**
- arithmetic operators, **63–71**, **94**
- arrays, **381–449**
  - accessing elements, **383–384**
  - assigning one, to another, **404–405**
  - averaging values in, **406–407**
  - binary search, **466–469**

- `BookInfo` structure, **625**
- bounds checking, **395–396**
- bubble sort, **476–479**
- comparing, **409–410**
- `const` key word, **418–419**
- contents of, **394**
- described, **381–382**
- elements, swapping, **479–481**
- `enum` with, **645–647**
- from file to, **392–393**
- as function arguments, **413–423**
- highest and lowest values, **407**
- initialization, **388–391**, **627**, **777**
- inputting and outputting, **384–388**
- linear search, **463–466**
- linked lists vs., **1123**
- memory requirements of, **382–383**
- National Commerce Bank case study, **433–435**
- of objects, **777–778**
- off-by-one error, **396–398**
- parallel, **410–413**
- partial initialization, **391–392**
- partially filled, **407–409**
- and pointers, **512–516**
- printing contents of, **405–406**
- processing array contents, **402–410**
- range-based `for` loop, **398–402**
- search algorithms, **463–469**

- selection sort, **482–486**
- `sizeof` operator, **689**
- sizing, **392**
- sorting algorithms, **476–486**
- and STL `vectors`, **435–448, 495–497**
- structure, **625–627**
- summing values in, **406**
- three or more dimensions, **431–433**
- two-dimensional, **424–431**
- `array` class, **1031–1033**
  - member functions, **1033**
- array subscript operator (`[ ]`), **435, 437–439, 596, 1043–1044**
- arrow operator (`->`), **637, 640, 738**
- ascending order, sorting in, **476**
- ASCII, **50, 51, 197**
- `assign` member function, string class, **598**
- assignment
  - combined, **107–109**
  - memberwise, **830–831**
  - multiple, **106**
- assignment operator (`=`), **39, 60–61, 106, 163–164, 596**
- assignment statement, **60**
- associative containers, **1030**
- associativity, **93–94, 190–191**
- `at()` member function
  - `array` class, **1033**
  - `map` class, **1059**

- `at` member function
  - `string` class, **598**
  - `vector`, **448**
- `atof` library function, **579**
- `atoi` library function, **579**
- `atol` library function, **579**
- attributes, **720**
- `auto` key word, **61–62**
  - to define iterator, **1037**
- averages
  - in arrays, **406–407**
  - calculating, **97–98**

# B

- `back()` member function, `array` class, **1033**
- `bad_alloc` exception, **1006–1007**
- `bad` member function, file stream, **676**
- base case, recursion, **1228**
- base class, **908**
  - abstract, **963–967**
  - multiple, **970–975**
- base class access specification, **912–913**, **920–921**
- base class functions, redefining, **936–940**
- base class pointers, **955–957**
- BASIC, **11**
- `begin` member function
  - `string` class, **598**
- `begin()` member function
  - `array` class, **1033**, **1035**
  - `map` class, **1060–1061**
- binary digit (bit), **6**
- binary files, **270**, **688–689**
- binary numbers, **9**
- binary operators, **63**
- binary predicate, **1111**
- binary search, **466–469**
  - efficiency, **469**



- recursive version, **1223–1226**
- `binary_search()` function, **1087–1090**
- binary trees, **1078, 1257–1258**
  - applications of, **1257–1258**
  - child nodes, **1257**
  - creating, **1261–1262**
  - deleting a node, **1268–1277**
  - described, **1257–1258**
  - inorder traversal, **1265**
  - inserting a node, **1262–1264**
  - leaf nodes, **1257**
  - NULL address, **1257**
  - operations, **1260–1277**
  - postorder traversal, **1265**
  - preorder traversal, **1265**
  - root node, **1257**
  - searching, **1267–1268**
  - searching for a value in, **1247**
  - search trees, **1259**
  - subtrees, **1258**
  - templates for, **1277–1282**
  - traversing, **1264–1266**
  - tree pointer, **1257**
- binding, **948**
  - dynamic, **949**
  - static, **949**
- bit, **6**
- blocks, of code, **213–216, 240–241**

- block scope, **214**
- blueprints, classes as, **723**
- body
  - of function, **307, 309**
  - of loop, **237**
- `bool`
  - data type, **58**
  - flag, **183**
  - returning from function, **338–340**
- Boolean expressions, **58, 152, 393**
- bounds checking, for arrays, **395–396**
- braces, **240–241**
- `break` statement, **206, 207, 288–290**
- bubble sort, **476–479**
- byte, **5–6**

# C

- C, **11**
- C#, **11**
- C++, **11**
- C++ **11, 437**
  - range-based `for` loop with `vector` in, **439**
- calling a function, **308–315**
- `capacity` member function
  - `string` class, **598**
  - `vector`, **448**
- `capacity()` member function, `vector` class, **1052–1053**
- capture list, **1111**
- capitalization, **43**
- case conversion, character, **561–563**
- `case` statement, **205–206**
- case study
  - Demetris Leadership Center, **469–476, 486–494**
  - `dollarFormat` function, **603–604**
  - General Crates, Inc., **134–137**
  - Home Software Company, **603–604, 788–791**
  - National Commerce Bank, **433–435**
  - United Cause, **544–549**
- catch block, **989**
- `catch` key word, **989**

- `cbegin()` member function, `array` class, **1033, 1038**
- CD (compact disc), **6**
- `cend()` member function, `array` class, **1033, 1038**
- central processing unit (CPU), **3–5**
- character case conversion, **561–564**
  - `tolower` function, **562**
  - `toupper` function, **562**
- character literals, **49, 50–53**
- characters, **17, 557–563**
  - character literals, **49, 50–53**
  - comparing, **197–200**
  - converting cases, **561–563**
  - and `string` objects, **120–126**
- character testing, **557–561**
  - functions, **559–560**
  - `isalnum` function, **558**
  - `isalpha` function, **558**
  - `isdigit` function, **558**
  - `islower` function, **558**
  - `isprint` function, **558**
  - `ispunct` function, **558**
  - `isspace` function, **558**
  - `isupper` function, **558**
- `char` data type, **49–53**
- `cin`, **18, 85–90**
  - entering multiple values, **87–89**
  - `getline` member function, **121, 567, 582–583**

- `get` member function, **122–124**
- `ignore` member function, **125, 583**
- inputting characters, **122**
- keyboard buffer, **89**
- `Circle` pointer, **639**
- circularly linked list, **1153**
- class constructors, **923–927**
- classes, **719–816, 817–906**
  - abstract base, **963–967**
  - accessors, **730**
  - access specifiers, **726–727**
  - aggregation, **866–871**
  - arguments to constructors, **759–764**
  - arrays of class objects, **777–778**
  - base, **908**
  - as blueprint, **723**
  - collaborations, **871–874**
  - `const` member functions, **728, 731**
  - constructor overloading, **771–773**
  - constructors, **754–766, 922–923**
  - conversion of class objects, **864–866**
  - copy constructor, **831–834**
  - and data hiding, **731**
  - declaration statements, **726**
  - default constructor, **759, 766**
  - defining class objects, **731–743**
  - derived, **908–909**
  - described, **726**

- destructors, **767–770**, **922–926**
- dot operator (`.`), **732**
- dynamically allocated objects, **739–740**, **769–770**
- finding, **794–802**
- forward declaration, **827**
- `friend` functions, **825–826**
- getter function, **730**
- “has a” relationship, **868**
- hierarchies of, **941–946**
- Home Software Company case study, **782–783**
- implementation file, **746**
- include guard, **746–747**
- inheritance, **907–916**
- inline member functions, **751–753**
- instance members, **817–824**
- “is a” relationship, **908–915**, **947**
- member functions, defining, **729–730**
- memberwise assignment, **830–831**
- multiple inheritance, **970–977**
- mutators, **730**
- objects vs., **719–722**
- operator overloading, **837–863**
- overloading member functions, **775**
- `PassFailExam`, **944**
- placement of public and private members, **728–730**
- pointers, **738–741**
- polymorphism, **947–963**
- private member functions, **775–777**

- private members, [726](#), [728–729](#), [744–745](#)
- problem domain, [795](#)
- and procedural/object-oriented programming, [719–725](#)
- protected members and class access, [916–921](#)
- public member functions, [728–729](#)
- public members, [726](#), [728–729](#)
- redefining base class functions, [936–940](#)
- responsibilities of, [794–816](#)
- scope resolution operator (`::`), [730](#), [766](#)
- setter function, [730](#)
- specification and implementation, [745–751](#)
- stale data, avoiding, [738](#)
- static members, [817–824](#)
- templates, [1008–1013](#)
- and UML, [792–794](#)
- virtual functions, [949–953](#)
- whole-part relationship, [868](#)
- class implementation file, [746](#)
- class specification file, [745](#)
- class template objects, [1018](#)
- class templates, [1014–1017](#)
  - defining objects of, [1018–1019](#)
  - and inheritance, [1020–1022](#)
  - linked list, [1131–1133](#)
  - type parameter, [1008](#)
- `clear` member function
  - file stream objects, [676](#)
  - `string` class, [598](#)

- `vector`, [445](#), [448](#), [1014–1015](#)
- C++ library, [557](#), [561](#), [564](#), [722](#)
- `close` member function, file stream objects, [273](#)
- closing of file, [273](#)
- `cmath` header file, [96](#), [126](#)
- COBOL, [11](#)
- code reuse, [306](#)
- collaborations, class, [871–876](#)
- combined assignment operators, [107–109](#)
- comments, [27](#), [71–73](#)
  - `/* */`, [72](#)
  - `//`, [27](#)
  - multi-line, [72–73](#)
  - single-line, [71–72](#)
- compact disc (CD), [6](#)
- `compare` member function, string class, [597–599](#)
- compilers, [12](#), [665](#)
  - default operations provided by, [894–895](#)
- compound operators, [107](#)
- concatenation, [569–570](#)
- conditional expression, [201–204](#)
  - value of, using, [202–203](#)
- conditional loop, [251](#)
- conditional operator, [201–204](#)
- console, [31](#)
- console output, [31](#)
- `const`
  - as array parameter, [418–419](#)



- copy constructors, [831–834](#)
- member functions, [728](#), [731](#)
- `const_iterator`, and mutable iterator, [1038](#)
- constants, [41](#)
  - arguments passed to, [759–766](#)
  - in base and derived classes, [922–933](#)
  - constructors, [754–757](#)
  - copy, [831–836](#)
  - default, [759](#), [764–766](#)
  - default arguments with, [764–766](#)
  - global, [344–346](#)
  - named, [73–75](#)
  - overloading, [771–773](#)
  - pointers to, [525–527](#)
- constructors
  - associative, [1030](#)
  - class, [923–927](#)
  - delegation, [774–775](#)
  - derived classes, [922](#)
  - inheritance, [933–934](#)
  - sequence, [1030](#)
  - STL, [435](#)
- containers
  - adapter class, [1030–1031](#)
  - `array` class, [1031–1033](#)
  - associative, [1030](#)
  - definition, [1029](#)
  - iterators and, [1034](#)

- sequence, **1030**
- `continue` statement, **290–292**
- control unit, **5**
- control variable, **239**
- conversion
  - object, **864–866**
  - string/numeric, **579–585**
- copy assignment operator, **841–843**
- copy constructors, **831–836**
  - `const` parameters in, **834–836**
  - default, **836**
  - and function parameters, **836**
  - `list` class, **1155**
  - `map` class, **1055**
  - `set` class, **1079**
  - `vector` class, **1041**
- `copy` member function, `string` class, **599**
- count-controlled loops, **251, 259–260**
- `count()` member function
  - `multimap` class, **1075–1076**
  - `multiset` class, **1085**
  - `set` class, **1082**
- `count_if()` function, **1093–1094**
- counters, **245–246**
- `cout`, **18, 31–36, 155**
  - `fixed` manipulator with, **116–117**
  - `left` manipulator with, **118–119**

- `right` manipulator with, **118–119**
- `setprecision` manipulator with, **113–115**
- `setw` manipulator with, **111–112**
- `showpoint` manipulator with, **117–118**
- `cout` statement, **233**
- C programming language, **10–11, 566**
- C++ programming language, **10, 11, 22**
  - arithmetic operators, **63–71**
  - assignment operation, **60–61, 62**
  - `auto` key word, **61–62**
  - `bool` data type, **58**
  - `char` data type, **49–53**
  - comments, **71–73**
  - `cout` object, **31–36**
  - floating-point data types, **55–58**
  - identifiers, **42–43**
  - `#include` directive, **36–38**
  - initialization, **60–61, 62**
  - integer data types, **43–48**
  - named constants, **73–75**
  - parts of program, **27–31**
  - programming style, **75–76**
  - scope, **62–63**
  - `sizeof` operator, **59**
  - `string` class, **53–54**
  - variables and literals, **38–41**
- CPU (central processing unit), **3–5**

- `crbegin()` member function, `array` class, **1033**
- CRC cards, **875–876**
- `crend()` member function, `array` class, **1033**
- C++ runtime library, **126**
- `cstdlib` header file, **579**
- `cstring` header file, **568, 573, 577**
- C-strings, **564–576**
  - in arrays, **566–568**
  - comparing, **574–576**
  - concatenation, **569–570**
  - copying, **570–571**
  - described, **564–565**
  - filenames as, **288**
  - handling functions, **585–590**
  - length of, **568–569**
  - library functions, **568–578**
  - and null terminators, **564–565**
  - numeric conversion functions, **579–585**
  - searching within, **570–574**
  - `strcmp` function, **593**
  - and string literals, **565–566**
- `c_str` member function, **288**
- `ctime` header file, **129**

# D

- database management systems (DBMS), **665**
- data hiding, **731**
- `data()` member function, `array` class, **1033**
- data types
  - abstract, **613–614**
  - `bool`, **58**
  - `char`, **49–53**
  - coercion, **100**
  - conversion, **100–101**
  - demotion, **100**
  - `double`, **55**
  - enumerated, **642–653**
  - `float`, **55**
  - floating-point, **55–58**
  - generic, **1008**
  - `int`, **44, 45**
  - integer, **43–48**
  - `long`, **45**
  - `long double`, **45**
  - numeric, **44**
  - primitive, **614**
  - promotion, **100**
  - ranking, **100–101**

- `short`, **44, 45**
- size of, determining, **59**
- `string` class, **53–54**
- type casting, **103–106**
- `unsigned int`, **44, 45**
- `unsigned long`, **44, 45**
- `unsigned short`, **44, 45**
- debugging
  - desk-checking, **21**
  - hand-tracing, **132–134**
  - stubs and drivers, **367–368**
- decision making, **151–230**
  - blocks and scope, **213–216**
  - checking numeric ranges, **191**
  - comparing characters and strings, **197–200**
  - conditional execution, **164–166**
  - conditional operator, **201–204**
  - flags, **183–184**
  - `if/else if` statements, **178–180, 182–183**
  - `if/else` statements, **168–170**
  - `if` statement, **156–164**
  - logical operators, **184–191**
  - menus, **192–195**
  - nested `if` statements, **171–174**
  - relational operators, **151–155**
  - relationship, value of, **152–154**
  - semicolons, **160**

- `switch` statement, **204–213**
- truth, **154–156**
- validating user input, **195–196**
- decode, **5**
- decrement operator (`--`), **231–236**
  - in mathematical expressions, **235**
  - postfix and prefix modes, **233–235**
  - in relational expressions, **235–236**
- default arguments, **351–354, 764–766**
- default constructors, **759, 766**
  - `list` class, **1154**
  - `map` class, **1055**
  - `set` class, **1079**
  - `vector` class, **1040**
- default copy constructor, **836**
- `default` statement, **205–206**
- `#define` directive, **747**
- `delete` operator, **531**
- Demetris Leadership Center case study, **469–476, 486–494**
- depth of recursion, **1224**
- `deque` (STL type), **1214–1216**
  - `front` member function, **1215**
  - `pop_front` member function, **1215**
  - `push_back` member function, **1215**
- dequeue operation, **1196–1197**
- dereferencing, of pointers, **509**
- derived class, **908**

- descending order, sorting in, **476**
- designing programs, **18–22**
- desk-checking, **21**
- destructors, **767–769, 922**
  - base and derived classes, in, **920–921**
  - virtual, **947–963**
- digital versatile disc (DVD), **6**
- direct access file, **271**
- direct recursion, **1234**
- disk drive, **6**
- division by zero, **169, 989–990**
- `dollarFormat` function case study, **603–604**
- dot operator (`.`), **618, 637, 732**
- `double` data type, **55**
- `double` literals, **57**
- double precision, **55**
- doubly linked list, **1153**
- `do-while` loops, **246–250, 266**
  - with menus, **248–251**
  - as posttest loop, **247**
- drivers, **367–369**
- dummy parameter, **849**
- DVD (digital versatile disc), **6**
- dynamic binding, **949**
- dynamic memory allocation, **530–534**
  - `bad_alloc` exception, **1006–1007**
  - objects, **738–741, 759, 770**
  - for structures, **639–640**



- dynamic queues, [1195](#), [1207–1214](#)
- dynamic stacks, [1166](#), [1182–1192](#)

# E

- efficiency
  - binary search, [469](#)
  - linear search, [465–466](#)
- elements (array)
  - accessing, [383–384](#)
  - described, [382](#)
  - processing, [402–410](#)
  - removing, from `vectors`, [444–445](#)
- `emplace()` member function
  - `map` class, [1058](#)
  - `multimap` class, [1075](#)
  - `set` class, [1081](#)
  - `vector` class, [1050–1052](#)
- `emplace_back()` member function, `vector` class, [1050–1052](#)
- `empty` member function
  - `string` class, [597](#)
  - `vector`, [446–447](#), [448](#)
- `empty()` member function, `array` class, [1033](#)
- encapsulation, [720](#)
- `#endif` directive, [746–747](#)
- `endl`, [33](#)
- `end` member function

- `string` class, **597**
- `end()` member function
  - `array` class, **1033, 1035**
  - `map` class, **1060–1061**
- end of file, detecting, **283–285**
- end-of-file marker, **668**
- enqueue operation, **1195–1198**
- `enum`, **642–653**
  - anonymous, **645**
  - with arrays, **645–647**
  - assigning, to `int` variables, **643**
  - assigning integers to `enum` variables, **643**
  - comparing enumerators, **643–644**
  - declaration and definition, **651**
  - defining, **643**
  - math operators with, **645**
  - outputting values with, **647–649**
  - and scope, **650–651**
  - specifying values, **649–650**
  - strongly-typed, **651–653**
- enumerated data types, **642–653**, see also `enum`
- enumerators, **643–644, 650–651**
- `eof` member function, file stream, **676**
- equal-to operator (`==`), **152–153, 163–164**
- `equal_range()` member function, `multiset` class, **1085**
- `erase` member function
  - `string` class, **597**

- `erase()` member function
  - `map` class, **1059**
  - `multimap` class, **1078**
- errors
  - logical, **21**
  - off-by-one, **396–398**
  - recovering from, **999–1001**
  - syntax, **12**
- error testing, files, **675–678**
- escape sequences, **34–36**
  - `\\`, **35**
  - `\,` **35**
  - `\,` **35**
  - `\a`, **35**
  - `\b`, **35**
  - `\n`, **35**
  - `\r`, **35**
  - `\t`, **35**
  - newline, **35**
- exception handler, **990**
- exceptions, **989–1007**
  - `bad_alloc`, **1006–1007**
  - catch block, **990**
  - dynamic memory allocation, **531**
  - exceptions handler, **990**
  - extracting data from, **1001–1005**
  - handling, **990–993**

- memory allocation error, **1006–1007**
- multiple, handling, **996–1001**
- `new` operator, **531**
- not catching, **993**
- object-oriented handling, **993–996**
- recovering from errors, **999–1001**
- rethrowing, **1006**
- throwing, **990**
- `throw` key word, **990**
- throw point, **990**
- try block, **990**
- try/catch construct, **990–993**
- unwinding the stack, **1005**
- executable file, **12**
- execute, **5**
- exhaustive algorithms, **1250–1253**
- `exit()` function, **364–366**
- exponents, **95–97**
- expressions, **85–137**
  - algebraic, **94–96**
  - arithmetic, **91–100**
  - case study, **134–137**
  - characters and `string` objects, **120–126**
  - `cin` object, **85–90**
  - conditional, **201–204**
  - C-style and prestandard C++ forms, **107–108**
  - formatting output, **110–120**
  - and hand tracing programs, **132–134**

- initialization, [252](#), [256](#)
- mathematical, [91–100](#), [235](#)
- and mathematical library functions, [126–132](#)
- multiple and combined assignment, [106–110](#)
- overflow and underflow, [102–103](#)
- relational, [235–236](#)
- type casting, [103–106](#)
- type conversion, [100–101](#)

# F

- factorial algorithm, **1228–1231**
- `fail` member function, file stream, **286**, 675, **676**
- false values, **152**, **154–155**, **162–163**
- fetch, **5**
- fetch/decode/execute cycle, **5**
- Fibonacci numbers, **1236–1237**
- field width, **111**, **113**
- FIFO (first-in first out), **1195**
- file access flags, **666**
  - `ios::app`, **666**
  - `ios::ate`, **666**
  - `ios::badbit`, **676**
  - `ios::binary`, **666**
  - `ios::eofbit`, **676**
  - `ios::failbit`, **676**
  - `ios::goodbit`, **676**
  - `ios::hardfail`, **676**
  - `ios::in`, **666**
  - `ios::out`, **666**
  - `ios::trunc`, **666**
- file access methods, **271**
- file buffer, **273**

- filename extensions, [271](#)
- filenames
  - and file stream objects, [271–272](#)
  - user-specified, [286–287](#)
- file open errors, [285–286](#)
- file operations, [665–717](#)
  - append mode, [666](#)
  - binary files, [688–693](#)
  - described, [666](#)
  - end-of-file marker, [668](#)
  - `fstream` data type, [666](#), [667](#), [705](#)
  - member functions for reading and writing, [678–685](#)
  - opening files for input and output, [705–709](#)
  - opening files with definition statements, [670–671](#)
  - opening multiple files, [686–688](#)
  - open modes of `ifstream` and `ofstream`, [669–670](#)
  - random-access files, [697–705](#)
  - reading a character, [678](#)
  - reading a line, [680](#)
  - records with structures, [693–697](#)
  - rewinding, [704–705](#)
  - writing a character, [684–685](#)
- files
  - closing of, [273](#)
  - for data storage, [269–288](#)
  - detecting end of, [283–285](#)
  - file open errors, [285–286](#)
  - input/output program, [272](#)



- opening, and creating file objects, **272–273**
- processing, with loops, **282–283**
- reading from, **278, 280–281**
- read position, **279–280**
- types of, **270–271**
- user-specified filenames, **286–287**
- writing to, **274**
- file stream objects, **271**
  - closing, **273**
  - creating, **272–273**
  - member functions, **678–685**
  - passing to functions, **673–675**
- fill constructor
  - `vector` class, **1040**
- `fill(value)` member function, `array` class, **1033**
- filters, **686**
- `final`, **961–963**
- `find()` member function
  - `map` class, **1062**
  - `multimap` class, **1076–1077**
  - `set` class, **1082–1083**
- finding classes, **794–802**
- `find` member function, `string` class, **599**
- first-in first-out (FIFO), **1195**
- `fixed` manipulator, **116–117, 671**
- flags, **183–184**
  - integer, **184**

- flash memory, **6**
- `float` data type, **55**
- floating-point data types, **55–58**
  - comparing, **161–162**
  - and integer variables, **57–58**
- floating-point literals, **56–57**
- floating point numbers, **44**
- `float` literals, **57**
- floppy disk drive, **6**
- flowcharts, **20**
- `for` loops, **251–261, 266**
  - counter variable, **255**
  - initialization expression, **252, 256**
  - omitting expressions of, **258–260**
  - as pretest loop, **255**
  - test expression, **252**
  - update expression, **252, 256, 257–258**
  - user-controlled, **256–257**
  - `while` and `do-while` vs., **254–255**
- `for_each()` function, **1092–1093**
- formal argument, **317**
- formal parameters, **317**
- formatting output, **110–120, 671–673**
  - `fixed` manipulator, **116–117**
  - `left` manipulators, **118–119**
  - `right` manipulators, **118–119**
  - `setprecision` manipulator, **113–115**

- `showpoint` manipulator, **117–118**
- FORTRAN, **11**
- forward declaration, **827**
- `forward_list` class, **1158**
- `friend` class, **829**
- `friend` functions, **825–829**
- `friend` key word, **825**
- `front` member function
  - `deque`, **1214**
- `front()` member function, `array` class, **1033**
- `fstream` header file, **272**
- `fstream` objects, **666**
- function arguments
  - file stream objects as, **673–675**
  - structures as, **631–633**
- function call operator, **1107**
- function call statements, **308**
- function declarations, **315**
- function header, **307**
- function object
  - anonymous, constructing, **1110**
  - definition, **1107**
- function parameters
  - pointers as, **521–529**
  - reference variables as, **354–359**
- function pointer, **1092**
- function prototypes, **315–316**

- functions, **28**
  - `bool` value, returning, **338–340**
  - calling, **308–315**
  - default arguments, **351–354, 764**
  - defining, **306–307**
  - `exit()`, **364–366**
  - friend, **825–829**
  - generic, **1008**
  - inline, **751–753**
  - local and global variables, **340–348**
  - `main`, **28–29, 308, 545**
  - member, **720**
  - menu-driven programs, **324–328**
  - modular programming, **305–306**
  - overloading, **360–364**
  - overriding, **958**
  - passing data by value, **322–323**
  - pointers, returning, **534–536**
  - prototypes, **315–316**
  - pure virtual, **963–967**
  - recursive, **1223–1227**
  - redefining base class, **936–940**
  - reference variables as parameters, **354–359**
  - `return` statement, **328–329**
  - sending data into, **317–321**
  - static local variables, **348–351**
  - static member, **822–825**
  - string handling, **585–590**

- structures, returning, **634–636**
- stubs and drivers, **367–369**
- value-returning, **330–338**
- virtual, **949–952, 963–967**
- `void`, **307**
- function signature, **361**
- function templates, **1008–1013**
  - with multiple types, **1012–1013**
  - overloading with, **1013**
  - using operators in, **1012**

# G

- games, [269](#)
- GCD (greatest common divisor), [1235–1246](#)
- General Crates, Inc. case study, [134–137](#)
- generalization, inheritance and, [907–908](#)
- generic data types, [1008](#)
- generic functions, [1008](#)
- `getArea` member function, [724](#)
- `getCircleData` function, [635](#)
- `getItem` function, [633](#)
- `getline` member function, [121](#)
  - `cin`, [567](#), [582–583](#)
  - file streams, [680–683](#)
- `get` member function, [122–124](#)
  - file streams, [683–684](#)
- getter functions, [730](#)
- global constants, [344–346](#)
- global variables, [342–344](#)
- `good` member function, file stream, [676](#)
- greatest common divisor (GCD), [1235–1236](#)

# H

- handler, exception, **990**
- hand tracing programs, **132–134**
- Hanoi, Towers of, **1243–1246**
- hardware, **3–7**
  - CPU, **3–5**
  - input devices, **7**
  - main memory, **5–6**
  - output devices, **7**
  - secondary storage, **6**
- “has a” relationship, **868**
- header
  - function, **307**
  - loop, **237, 252**
- header file, **28**
  - `cmath`, **96, 126**
  - `cstdlib`, **365, 579**
  - `cstring`, **568**
  - `ctime`, **129**
  - `fstream`, **272**
  - `iomanip`, **112, 115**
  - `iostream`, **28, 36–37**
  - `string`, **53, 591**
  - STL, **1030**

- hexadecimal literals, **48**
- hiding data, **720**, **731**
- hierarchies, class, **941–946**
- hierarchy chart, **20**
- high-level languages, **10**
- Hoare, C.A.R., **1246**
- Home Software Company case study, **603–604**



- identifiers, [42–43](#)
  - capitalization, [43](#)
  - legal, [43](#)
- `if/else if` statements, [178–180](#)
  - nested decision structures vs., [182–183](#)
  - trailing else, [181](#)
- `if/else` statements, [168–170](#)
- `#ifndef` directive, [746–747](#)
- `if` statement
  - conditionally executed code, [158](#), [164–166](#)
  - expanding, [164–167](#)
  - floating-point comparisons, [161–162](#)
  - nested, [171–174](#)
  - programming style, [161](#)
  - semicolon in, [160](#)
- `ifstream` objects, [272](#), [669](#)
  - `close` member function, [273](#)
  - `open` member function, [273](#)
  - `>>` with, [278](#)
- `ignore` member function, `cin`, [125](#), [582](#)
- image editors, [269](#)
- implementation file, class, [745](#)
- `#include` directive, [28](#), [36–38](#), [725](#), [746](#), [750](#)

- in-place initialization, **758**
- include file directory, **749**
- `includes()` function, **1095**
- include guard, **746–747**
- increment operator (`++`), **231–236**
  - in mathematical expressions, **235**
  - postfix and prefix modes, **233–235**
  - in relational expressions, **235–236**
- indirection operator (`*`), **509**
- indirect recursion, **1234**
- infinite loops, **240**
- inheritance, **907–915**
  - base class, **908**
  - class hierarchies, **941–946**
  - and class templates, **1018–1022**
  - constructor, **933–934**
  - constructors and destructors, **922–927**
  - derived class, **908–909**
  - “is a” relationship, **908–915**
  - multiple, **970–977**
  - redefining functions, **936–940**
- initialization, **60–61, 62**
  - array, **388–391, 427–428, 627**
  - `for` loops, **252, 256**
  - pointers, **518–519**
  - structure, **622–624**
  - structure array, **627**
- inline expansion, **753**

- inline member functions, **751–753**
- inorder traversal, binary trees, **1265**
- input, **17–18**
  - array contents, **384–388**
  - with `cin`, **85–89**
  - reading, into `string` objects, **591**
- input devices, **7**
- input file, **269, 272**
- input–output stream library, **36**
- input validation
  - and decision making, **195–196**
  - and `while` loops, **243–245**
- `insert` member function
  - `string` class, **603**
- `insert()` member function
  - `map` class, **1058**
  - `multimap` class, **1075**
  - `set` class, **1081**
  - `vector` class, **1045–1047**
- instances
  - of class, **723**
  - of classes, **731–741**
  - of structures, **618**
  - variables, **817–818**
- instantiation, **731**
- `int`, **44, 45, 643**
- integer data types, **43–48**

- integer division, [64](#), [66](#), [101](#)
- integer flags, [184](#)
- integer literals, [47](#)
- integer variables, [57–58](#)
- integrated development environments (IDE), [12](#)
- `iomanip` header file, [112](#), [115](#)
- `ios::app` access flag, [666](#)
- `ios::ate` access flag, [666](#)
- `ios::badbit` status flag, [676](#)
- `ios::binary` access flag, [666](#), [689](#)
- `ios::eofbit` status flag, [676](#)
- `ios::failbit` status flag, [676](#)
- `ios::goodbit` status flag, [676](#)
- `ios::hardfail` status flag, [676](#)
- `ios::in` access flag, [666](#)
- `ios::out` access flag, [666](#)
- `iostream` header file, [28](#), [36–37](#)
- `ios::trunc` access flag, [666](#)
- `isalnum` library function, [558](#)
- `isalpha` library function, [558](#)
- “is a” relationship, [908–915](#), [947](#)
- `is_permutation()` function, [1090–1092](#)
- `isdigit` library function, [558](#)
- `islower` library function, [558](#)
- `isprint` library function, [558](#)
- `ispunct` library function, [558](#)

- `isspace` library function, **558**
- `isupper` library function, **558**
- iteration, **238**
- iterators, **1034–1039**
  - association with containers, **1034**
  - `auto` to define, **1037**
  - categories of, **1034**
  - definition, **1034–1035**
  - and `map` class, **1060–1062**
  - mutable, **1038**
  - reverse, **1038–1039**
  - and `set` class, **1082**
  - usage in `vector` class, **1045**
- `itoa` library function, **584**

# J

- Java, [11](#)
- JavaScript, [11](#)

# K

- keyboard buffer, **89**
- key–value pairs, **1054**
- key words, **14**

# L

- lambda expression, [1107](#), [1111–1112](#)
- language elements, [14](#)
- last-in-first-out (LIFO), [1165](#)
- `left` manipulator, [118–119](#)
- legacy code, [566](#)
- legal identifiers, [43](#)
- length, of C-strings, [568–569](#)
- `length` member function, `string` class, [597](#), [603](#)
- library functions, [95](#)
  - `atof`, [579](#)
  - `atoi`, [579](#)
  - `atol`, [579](#)
  - for C-strings, [578–578](#)
  - `isalnum`, [558](#)
  - `isalpha`, [558](#)
  - `isdigit`, [558](#)
  - `islower`, [558](#)
  - `isprint`, [558](#)
  - `ispunct`, [558](#)
  - `isspace`, [558](#)
  - `isupper`, [558](#)
  - `itoa`, [584](#)



- `strcat`, [569–570](#), [577](#)
- `strcmp`, [574–576](#)
- `strcpy`, [570–571](#), [578](#)
- `strlen`, [568–569](#), [577](#)
- `strncat`, [571](#)
- `strncpy`, [571](#)
- `strstr`, [572–574](#), [578](#)
- `tolower`, [561](#)
- `toupper`, [561](#)
- lifetime, of variables, [342](#)
- LIFO (last-in, first-out), [1165](#)
- linear search
  - algorithm for, [463–465](#)
  - efficiency, [465–466](#)
- lines, [16](#)
- `LinkedList` class template, [1147](#)
- linked lists
  - appending a node, [1126–1131](#)
  - `arrays` and `vectors` vs., [1123–1158](#)
  - circularly, [1153](#)
  - circularly linked, [1153](#)
  - class as node type, [1147–1153](#)
  - composition of, [1124](#)
  - counting nodes, [1238–1239](#)
  - declarations, [1124–1125](#)
  - deleting a node, [1137–1140](#)
  - described, [1123](#)

- destroying, **1139–1140**
- displaying nodes in reverse, **1239–1241**
- doubly linked, **1153**
- inserting a node, **1133–1137**
- list head, **1124**
- NULL address, **1124**
- operations, **1125–1141**
- recursion with, **1237–1241**
- self-referential data structure, **1125**
- singly linked, **1153**
- template for, **1141–1153**
- traversing, **1131–1133**
- variations of, **1153**
- linker, **12**
- `list` class, **1154–1158**
  - definition statements, **1154–1155**
  - member functions, **1155–1157**
- list head, linked list, **1124**
- literals, **40–41**
  - character, **49, 50–53**
  - `double`, **57**
  - `float`, **57**
  - floating-point, **56–57**
  - hexadecimal, **48**
  - integer, **47**
  - long integer, **47**
  - octal, **48**
  - string, **41, 50–53, 565–566**

- local scope, [214](#)
- local variables, [340–342](#)
  - initializing, with parameter values, [342](#)
  - lifetime of, [342](#)
  - with same name as global, [347–348](#)
  - static, [348–351](#)
- logical errors, [21](#)
- logical operators, [184–191](#)
  - `&&` (AND), [184–186](#)
  - `!` (NOT), [189–190](#), [576](#)
  - `||` (OR), [186–189](#)
  - associativity, [190–191](#)
  - and numeric ranges, [191](#)
  - precedence, [190–191](#)
  - short-circuit evaluation, [185](#), [187](#)
- `long` data types, [44](#), [45](#)
- `long double` data types, [44](#), [45](#)
- long double precision, [55](#)
- long integer literals, [47](#)
- long long integer literal, [48](#)
- loop header, [237](#), [252](#)
- loops, [231–292](#)
  - breaking and continuing, [288–292](#)
  - conditional, [251](#)
  - control variable, [239](#)
  - count-controlled, [251](#), [259–260](#)
  - counters, [245–246](#)
  - described, [236](#)

- `do-while`, **246–250, 266**
- and files, **269–288**
- `for`, **251–261, 266**
- and increment/decrement operators, **231–236**
- infinite, **240**
- input validation with, **243–245**
- nested, **266–268**
- posttest, **246–248**
- pretest, **239, 255**
- processing files with, **282–283**
- programming style, **241–242**
- running total, **261–263**
- selecting, **265–266**
- sentinels, **264–265**
- user-controlled, **248, 256–257**
- `while`, **236–242, 265**
- lowercase conversion, character, **561–563**
- low-level languages, **10**
- lvalues, **886–888**
  - references, **888**

# M

- machine language, **9**
- `main` function, **28–29**, **545**
- main memory, **5–6**
- manipulators
  - `fixed`, **116–117**
  - `left`, **118–119**
  - `right`, **118–119**
  - `setprecision`, **113–115**
  - `showpoint`, **117–118**
  - `stream`, **33**, **119**
- mantissa, **55**
- `map` class, **1054**
  - add new elements to, **1057**
  - `at()` member function, **1059**
  - definition statements, **1055**
  - `emplace()` member function, **1058**
  - `erase()` member function, **1059**
  - initializing, **1056–1057**
  - `insert` member function, **1058**
  - iterators and, **1060–1062**
  - keys in, **1069–1071**
  - member functions, **1055–1056**

- range-based `for` loop, **1060**
- storing own classes objects as values in, **1065–1069**
- storing `vectors` as values in, **1062–1064**
- mathematical expressions, **91–100, 235**
  - algebraic, to programming statements, **94–95**
  - associativity, **93–94**
  - exponents, **95–97**
  - grouping with parentheses, **94**
  - operator precedence, **92–93**
- mathematical library functions, **126–132**
  - random numbers, **128–131**
- mathematical operators, with `enum`, **645**
- `max_size()` member function, `array` class, **1033**
- `max_size()` member function, `vector` class, **1052–1053**
- member access specification
  - defined, **920**
  - inherited, **920**
- member functions, **720, 945**
  - `array` class, **1033**
  - binding, **948**
  - dynamic binding, **949**
  - `getLength`, **744**
  - `getObjectCount`, **820**
  - `getTaxRate`, **763**
  - `list` class, **1155–1157**
  - `map` class, **1055–1056**
  - `multimap` class, **1072–1073**

- other overloaded, **775**
- overriding, **958**
- private, **775–777, 781**
- public, **781–782**
- redefining, **936–940, 958**
- `set` class, **1080**
- `set Length`, **744, 745**
- static, **822–824**
- static binding, **949**
- static stack class, **1167**
- `vector` class, **1041–1043**
- virtual, **949–952**
- `withdraw`, **783**
- member initialization list, **758**
  - usage with aggregate classes, **870**
- members, of structures, **615, 618–621, 640–641**
- member variable
  - static stack class, **1167**
- memberwise assignment, **830–831**
- memory
  - flash, **6**
  - main, **5–6**
  - random-access, **5**
- memory address, **6, 404**
- memory allocation, dynamic, see **dynamic memory allocation**
- memory leak, **532**
  - avoiding, **541–544**
- memory requirements of arrays, **382–383**

- menu-driven programs, **192, 324–328**
- menus, **192–195, 209–211**
- message, **23**
- methods, **719**
- microprocessors, **4**
- modular program, **324**
- modular programming, **305–306**
- move semantics, **889–894**
  - implementation in class, **894**
- multi-line comments, **72–73**
- `multimap` class, **1072**
  - adding elements to, **1075**
  - `count()` member function, **1075–1076**
  - `emplace()` member function, **1075**
  - `erase()` member function, **1078**
  - `find()` member function, **1076–1077**
  - `insert` member function, **1075**
  - member functions, **1072–1073**
- multiple assignment, **106**
- multiple inheritance, **970–977**
- `multiset` class, **1085**
- mutable iterators, **1038**
- mutators, **730**



# N

- named constants, [73–75](#)
- names
  - of functions, [307](#)
  - of variables, [43](#), [215–216](#), [347–348](#)
- `nameSlice` functions, [586](#)
- namespaces, [28](#)
- National Commerce Bank, case study, [433–435](#)
- negation operator (2), [63](#), [93](#), [94](#)
- nested `if` statements, [171–174](#)
- nested loops, [266–268](#)
  - `break` statement in, [290](#)
- nested structures, [627–630](#)
- newline escape sequence, [35](#)
- `new` operator, [530–532](#)
- nodes, [1123](#)
  - appending, [1126–1131](#)
  - of binary trees, [1257](#), [1262–1264](#), [1268–1277](#)
  - class as node type, [1147–1153](#)
  - counting, [1238–1239](#)
  - deleting, [1137–1140](#), [1268–1277](#)
  - displaying, in reverse, [1239–1241](#)
  - inserting, [1133–1137](#), [1262–1264](#)
  - of linked lists, [1123](#), [1126–1137](#), [1147–1153](#), [1238–1241](#)

- NOT (!) operator, **576**
- null character, **51, 564**
- null pointer, **508**
- `nullptr`, **508**
- null statement, **160**
- null terminator, **51, 564–565**
  - `userName[count]`, **587, 588**
- numbers, **17**
- numbers, random, **128–131**
- numeric data
  - checking ranges of, **191**
  - integer data types for, **44**
  - from text files, **280–281**

# O

- object aggregation, **866–871**
- object code, **12**
- object conversion, **864–866**
- object file, **12**
- object-oriented design
  - aggregation, **866–871**
  - class collaborations, **871–874**
  - classes, finding, **794–803**
  - CRC cards, **875–876**
  - generalization and specialization, **907–908**
  - inheritance, **907–916**
  - problem domain, **795**
  - responsibilities, identifying, **800–802**
  - UML, **792–794, 870–871**
- object-oriented programming (OOP), **22, 23, 719–725**
  - game simulation, **876–882**
  - problem solving, **781–788**
  - Unified Modeling Language, **792–794**
- object reusability, **722**
- objects, **719, 722–724**, class vs.
  - array of, **777–778**
  - attributes, **720**
  - data hiding, **720–721**
  - dynamically allocated, **739–741, 759**

- encapsulation, [720](#)
- methods, [721](#)
- pointers, [738–741](#)
- state, [735](#)
- octal literals, [48](#)
- off-by-one error, [396–398](#)
- off position, [6](#)
- `ofstream` objects, [272](#), [669–670](#)
  - `close` member function, [273](#)
  - `open` member function, [273](#)
  - `<<`, used with, [274](#)
- one-dimensional arrays, [425](#)
- on position, [6](#)
- OOP, [22](#), [23](#), [719–725](#)
- `open` member function, file stream objects, [273](#)
- operands, [60](#), [100](#)
- operating systems, [7](#)
- operator functions, [838](#)
- operator overloading, [837–863](#)
  - `[]` operator, [596](#), [858–861](#)
  - `>>` and `<<` operators, [854–858](#)
  - `=` operator, [838–839](#)
  - general issues, [843–844](#)
  - math operators, [844–849](#)
  - postfix `++` operator, [849–850](#)
  - prefix `++` operator, [849](#)
  - relational operators, [852–854](#)

- operators, **14, 15**
  - `(-)` negation, **63**
  - `-` (subtraction), **64**
  - `--`, **231–235**
  - `--=`, **107–109**
  - `->` (object pointer), **739**
  - `->` (structure pointer), **637–638, 639–641**
  - `!`, **184, 189–190, 576**
  - `!=`, **152–154**
  - `%` (modulus), **64, 93**
  - `%=`, **107–109**
  - `&` (address), **503–505**
  - `&&`, **184–186, 393**
  - `*` (indirection), **509**
  - `*` (multiplication), **64, 93–94**
  - `*` (pointer variable declaration), **640–641**
  - `*=`, **107–109**
  - `.` (dot operator), **618, 732**
  - `/` (division), **64, 93**
  - `/=`, **107–109**
  - `?:`, **201**
  - `||` (OR), **184, 186–189**
  - `+`, **64, 93, 596**
  - `++`, **231–235**
  - `+=`, **107–109, 596**
  - `<`, **152–154**

- `<<`, [32](#), [274](#)
- `<=`, [152–154](#)
- `=`, [596](#)
- `==`, [152–154](#), [163–164](#), [241](#)
- `>`, [152–154](#)
- `>=`, [152–154](#)
- `>>`, [86](#), [596](#)
- `[]` operator, [435](#), [437–439](#), [596](#)
- associativity, [93–94](#), [190–191](#)
- binary, [63](#), [64](#)
- copy assignment, [841–843](#)
- overloading, [837–863](#)
- precedence of, [92–93](#), [190–191](#)
- relational, see [relational operators](#)
- scope resolution (`::`), [730](#)
- `string` class, [96](#)
- ternary, [63](#)
- unary, [63](#)
- OR
  - with `enum`, [647–649](#)
  - formatting, [671–673](#)
  - `||` logical operator, [186–189](#)
- output, [18](#)
- output devices, [7](#)
- output file, [269](#), [272](#)
- overflow, [102–103](#)
- overhead, [1228](#)

- overloading functions, **360–364**
  - constructors, **771–773**
  - member functions, **767**
  - templates, **1013**
- `override`, **961–963**
- overriding, **958**

# P

- parallel arrays, [410–413](#)
- parameters
  - array, [417](#)
  - pointers as, [521–529](#)
  - reference variables as, [354–359](#)
- parentheses, [94](#)
- partially filled arrays, [407–409](#)
- Pascal, [11](#)
- passing by value, [322–323](#)
- passing to functions
  - with pointers, [588–590](#)
- percentage discounts, [67–70](#)
- permutations, algorithms for detection, [1090–1092](#)
- pointers, [503–549](#)
  - address operator (`&`), [503–505](#)
  - arithmetic with, [516–517](#)
  - and arrays, [512–516](#)
  - base class, [955–957](#)
  - comparing, [519–521](#)
  - constant, [528–529](#)
  - constant, to constants, [529](#)
  - to constants, [525–527](#)
  - creating and using, [507–512](#)
  - dynamic memory allocation, [530–534](#)



- as function parameters, **521–529**
- initializing, **518–519**
- to objects, **738–741**
- passing C-string arguments with, **588–590**
- returning, from a function, **534–536**
- smart, **541–543**
- structure pointer operator, **637–638, 640, 641**
- to structures, **637–639**
- structures containing, **697**
- United Cause case study, **544–548**
- pointer variables, see **pointers**
- polymorphism, **947–963**
  - abstract base classes, **963–967**
  - base class pointers, **955–957**
  - dynamic binding, **949**
  - overriding, **958**
  - pure virtual function, **963–967**
  - and references or pointers, **953–955**
  - references/pointers, **953–955**
  - static binding, **949**
  - virtual destructors, **947–963**
  - virtual functions, **949–952, 963–967**
- `pop_back` member function
  - `vector`, **448**
- `pop_front` member function
  - `deque`, **1214**
- pop operation (stacks), **1166**
- postfix mode, **233–235**

- postorder traversal, binary trees, **1265–1266**
- posttest loop, **246–248**
- `pow` function, **95–97, 128**
- precedence, operator, **92–93, 190–191**
- predicate, **1111**
- prefix, template, **1008, 1013**
- prefix modes, **233–235**
- preorder traversal, binary trees, **1265**
- preprocessor, **11**
- preprocessor directive, **28, 29**
- prestandard C++
  - standard vs., **75–76**
  - type cast expressions, **107–108**
- pretest loop, **239**
- priming read, **244**
- primitive data types, **614**
- `priority_queue` (adapter class), **1031**
- private member functions, **775–777**
- private members, class, **728–729, 744–745**
- problem domain, **795**
- procedural programming, **22–23, 719–722**
- processing, **19**
- processing array contents, **402–410**
- programmability, of computers, **1–2**
- programmer-defined data types, **435**
- programmer-defined identifiers, **14, 15**
- programmers, **2, 9**
- programming, **1–23**

- computer systems
- input, processing, and output, **17–18**
- procedural and object-oriented, **22–23**
- process of, **18–22**
- programability of computers, **1–2**
- program elements, **14–17**
- programs and programming languages, **8–13**
- programming languages, **8–11**, see *also* specific languages
  - high-level, **10**
  - low-level, **10**
- programming process, **18–22**
- programming style, **75–76**
  - and `if` statements, **161**
  - and nested decision structures, **174–175**
  - and `while` loops, **241–242**
- programs
  - defined, **1**
  - described, **8–9**
  - designing/creating, **18–22**
  - elements, **14–17**
  - primary activities of, **17–18**
- protected members, **916–921**
- prototypes, function, **315–316**
- pseudocode, **20–21**, **64**, **466**
- public member functions, **728–729**
- public members, class, **728–729**
- punctuation, **14**, **15–16**
- pure virtual function, **963–967**

- `push_back` member function
  - `deque`, **1214**
  - `vector`, **441–442, 448**
- `push` operation (stacks), **1166**
- `put` member function, file streams, **684–686**
- Python, **11**

# Q

- `queue` (adapter class), **1031**
- `queue` (STL type), **1216–1217**
- `queue` container adapter, **1216–1217**
- queues, **1195–1217**
  - applications of, **1195**
  - array-based, **1198**
  - crawling problem with array, **1197**
  - dequeuing, **1195**
  - described, **1195**
  - dynamic, **1195, 1207–1210, 1207–1214**
  - dynamic template, **1211–1214**
  - empty, detecting, **1198**
  - enqueueing, **1195–1198**
  - first-in, first-out, **1195**
  - full, detecting, **1198**
  - linked list-based, **1207–1210**
  - operations, **1195–1198**
  - static, **1195, 1198–1202**
  - static template, **1203–1206**
  - STL `queue` and `dequeue` containers, **1214–1217**
- QuickSort algorithm, **1246–1250**

# R

- RAM, [5](#)
- random-access files, [271](#), [697–705](#)
- random-access memory (RAM), [5](#)
- random file access, [697](#)
- random numbers, [128–131](#)
  - limiting range of, [130](#)
  - seeding, [129](#)
  - `time` function with, [129](#)
- range-based `for` loop, [398–402](#)
  - `map` class, [1060](#)
  - modifying array with, [400–402](#)
  - `set` class, [1081](#)
  - *versus* regular `for` loop, [402](#)
- range constructor
  - `list` class, [1155](#)
  - `map` class, [1055](#)
  - `set` class, [1079](#)
  - `vector` class, [1041](#)
- range variable, [398](#)
- `rbegin()` member function, `array` class, [1033](#), [1038](#)
- reading data, from file, [278](#), [280–281](#)
- `read` member function, file stream objects, [689–691](#)
- read position, [279–280](#)

- records, [693–697](#)
- recursion, [1223–1253](#)
  - base case, [1228](#)
  - binary search, [1241–1243](#)
  - counting characters, [1231–1234](#)
  - depth of, [1224](#)
  - direct, [1234](#)
  - exhaustive algorithms, [1250–1253](#)
  - factorial algorithm, [1228–1231](#)
  - Fibonacci numbers, [1236–1237](#)
  - greatest common divisor (GCD), [1235–1236](#)
  - indirect, [1234](#)
  - infinite, [1223](#)
  - iteration vs., [1253](#)
  - linked list operations, [1237–1241](#)
  - problem solving with, [1227–1234](#)
  - QuickSort algorithm, [1246–1250](#)
  - recursive functions, [1223–1227](#)
  - recursively defined problems, [1236–1237](#)
  - Towers of Hanoi, [1243–1246](#)
- recursive case, [1228](#)
- redefining base class functions, [936–940](#), [947](#)
- reference parameters, constant, [648](#)
- reference variables
  - as parameters, [354–359](#)
  - pointers vs., [521–522](#)
- `reinterpret_cast`, [691](#), [693](#)
- relational expressions, [152](#), [235–236](#)

- relational operators, **151–155**
  - and characters, **197–198**
  - and pointers, **519**
  - and `string` class, **198–200**
  - truth, **154–156**
  - value of relationship, **152–154**
- relationships
  - “has a,” **868**
  - “is a,” **908–915, 947**
  - whole-part, **868**
- `rend()` member function, `array` class, **1033, 1038**
- `replace` member function, `string` class, **603**
- `reserve()` member function, `vector` class, **1052–1053**
- reserved words, **15**
- `resize` member function,
  - `string` class, **598**
  - `vector`, **449**
- responsibilities, identifying, **800–803**
- rethrowing an exception, **1006**
- returning
  - `bool` value from functions, **338–340**
  - pointers from functions, **534–539**
  - structures from functions, **634–636**
  - values from functions, **330–338**
- `return` statement, **328–329**
- reusability, object, **722**
- reverse iterator, **1038–1039**



- `reverse` member function
  - `vector`, **448**
- rewinding a file, **704–705**
- `right` manipulators, **118–119**
- Ruby, **11**
- running, of programs, **5**
- running total (`for` loops), **261–263**
- run-time library, **12**
- rvalues, **60, 886–888**
  - references, **888–889**

# S

- scope, **62–63**
- scope resolution operator (`::`), **730, 766**
- search algorithm
  - binary search, **466–469, 1241–1243**
  - Demetris Leadership Center case study, **469–476**
  - linear search, **463–466**
  - for STL `vector`, **495–497**
- search trees, binary, **1259**
- secondary storage, **6**
- `seekg` member function, file stream objects, **697–702**
- `seekp` member function, file stream objects, **697–702**
- selection sort algorithm, **482–486**
- self-referential data structure, **1125**
- semicolons, **160**
- sentinels, **264–265**
- sequence containers, **1030**
- sequence structure, **156**
- sequential file access, **271, 697**
  - `seekg` member function, **704–705**
- sequential search, **463**
- `set` class, **1079**
  - `count` () member function, **1082**
  - definition statements, **1079**

- `emplace()` member function, **1081**
- `find()` member function, **1082–1083**
- `insert()` member function, **1081**
- iterators and, **1082**
- member functions, **1080**
- range-based `for` loop, **1081**
- store objects of class in, **1083–1085**
- `set_difference()` function, **1095, 1099–1100**
- `set_intersection()` function, **1095, 1098–1099**
- `set_symmetric_difference()` function, **1095, 1101–1102**
- `set_union()` function, **1095, 1096–1098**
- `setprecision` manipulator, **113–115, 671**
- setter functions, **730**
- `setw` manipulator, **672–673**
- `shared_ptr`, **541**
- `short`, **44, 45**
- short-circuit evaluation, **185, 187**
- `showItem` function, **633**
- `showpoint` manipulator, **117–118**
- `shrink_to_fit()` member function, `vector` class, **1052–1053**
- single-line comments, **71–72**
- single precision, **55**
- singly linked list, **1153**
- size declarators, of arrays, **382**
- `size` member function
  - `string` class, **603**
  - `vector`, **443–444**

- `size()` member function, `array` class, **1033**
- `sizeof` operator, **59**
- smart pointers, **541–544**
- software
  - application, **7–8**
  - system, **7**
- software developers, **1**
- software development tools, **7**
- software engineering, **22, 530–536, 1014, 1253**
- `sort` algorithm (STL), **1026**
- `sort()` function, **1087–1090**
- sorting, of strings, **576–578, 592–594**
- sorting algorithm
  - bubble sort, **476–479**
  - Demetris Leadership Center case study, **486–494**
  - QuickSort, **1246–1249**
  - selection sort, **482–486**
  - for STL `vector`, **495–497**
- source code, **11**
- source files, **11**
- specialization, inheritance and, **907–908**
- specialized templates, **1023**
- specification file, class, **745**
- spreadsheets, **269, 665**
- `stack` (adapter class), **1031**
- `stack` (STL type), **1193–1194**
- stacks, **1165–1217**
  - applications of, **1166**

- array-based, **1166**
- cafeteria plates, **1165–1166**
- described, **1165–1166**
- dynamic, **1166, 1182–1192**
- implementing, **1173–1175**
- `isEmpty` function, **1185**
- `isEmpty` operation, **1167**
- `isFull` operation, **1167**
- LIFO, **1165**
- linked list-based, **1182–1187**
- for math, **1173–1175**
- operations, **1166–1167, 1173–1175**
- pop, **1166–1167**
- push, **1166**
- static, **1166–1167, 1176–1182**
- STL stack container, **1193–1194**
- unwinding, **1005**
- stale data, **738**
- Standard Template Library (STL), **435, 1029**
  - algorithms to perform set operations, **1094–1103**
  - `array` class, **1031–1033**
  - associative containers, **1029**
  - `forward_list` class, **1158**
  - functional classes in, **1113–1114**
  - header files, **1030**
  - `includes()` function, **1095**
  - iterators (see **iterators**)
  - `list` class, **1154–1158**

- `queue`, **1216–1217**
- sequence containers, **1029**
- `set_difference()` function, **1095, 1099–1100**
- `set_intersection()` function, **1095, 1098–1099**
- `set_symmetric_difference()` function, **1095, 1101–1102**
- `set_union()` function, **1095, 1096–1098**
- `stack`, **1193–1194**
- storing objects, **1193–1194**
- `vector`, **435–449, 495–497**
- state, object, **735**
- statements, **16**
- static binding, **949**
- `static` key word, **818**
- static local variables, **348–351**
- static member functions, **822–825**
- static member variables, **818–822**
- static queues, **1195, 1198–1202**
  - template, **1203–1206**
- static stacks, **1166–1173, 1176–1182**
- STL, see **Standard Template Library**
- storage, secondary, **6**
- `strcat` library function, **569–570, 577**
- `strcmp` library function, **574–576**
- `strcpy` library function, **570, 578**
- stream extraction operator, **86**
- stream insertion operator, **32, 274, 596**
- stream manipulator, **33, 119**

- stream object, **31**
- `string` class, **591–599, 725**
  - `append` member function, **598**
  - `assign` member function, **598**
  - `begin` member function, **599**
  - `capacity` member function, **599**
  - `clear` member function, **599**
  - `compare` member function, **599**
  - comparing and sorting, **592–594**
  - constructors, **771**
  - `copy` member function, **599**
  - defining `string` objects, **591–592, 595–596**
  - described, **53–54**
  - `empty` member function, **599**
  - `end` member function, **599**
  - `erase` member function, **599**
  - `find` member function, **599**
  - Home Software Company case study, **603–604**
  - input, reading into a string object, **592**
  - `insert` member function, **603**
  - `length` member function, **597, 599**
  - `at` member function, **598**
  - member functions, **597–599**
  - operators, **596**
  - and relational operators, **198–200**
  - `replace` member function, **599**
  - `resize` member function, **599**

- `size` member function, **599**
- `substr` member function, **599**
- `swap` member function, **599**
- using, **53–54**
- string constant, **29**
- `stringCopy` function, **586**
- `string` header file, **53, 591**
- string literals, **29, 41, 50–53**
- `string` literals, **565–566**
- `string` objects
  - and characters, **120–126**
  - comparing, **198–200**
  - defining, **591–592, 595–596**
  - functions for handling, **585–590**
  - member functions and operators, **126**
  - numeric conversion functions, **579–585**
  - reading input into, **592**
  - sorting, **576–579**
- string tokenizing, **600–601**
- `strlen` library function, **568–569, 577**
- `strncat` library function, **578**
- `strncpy` library function, **578**
- strongly typed `enum`, **651–653**
- `strstr` library function, **572–574, 578**
- `struct`, **615**, see also **structures**
- structure pointer operator (`->`), **637–640**
- structures, **613–653**



- and abstract data types, **613–615**
- accessing structure members, **618–621**
- arrays of, **625–627**
- combining data into, **615–618**
- containing pointers, **697**
- and enumerated data types, **642–653**
- as function arguments, **631–634**
- initializing, **622–624**
- nested, **627–630**
- pointers as members of, **640–641**
- pointers to, **637–640**
- records, creating with, **693–697**
- returning, from a function, **634–636**
- self-referential, **1125**
- structure variables, **617–618, 621**
- stubs, **367–369**
- subscript, of array element, **383**
- `substr` member function, string class, **599**
- `swap` member function, **449**
  - `string` class, **603**
- `sweep (second)` member function, `array` class, **1033**
- `switch` statement, **204–213**
  - `break`, **206, 207**
  - `case`, **205–206**
  - `default`, **205–206**
  - fallthrough capability, **207–209**
  - with menus, **209–211**
- syntax, **14**

- syntax errors, [12](#)
- system software
  - operating system, [7](#)
  - software development tools, [7](#)
  - utility program, [7](#)

# T

- tags, of structures, **616**, **618**
- `tellg` member function, file stream objects, **702–704**
- `tellp` member function, file stream objects, **702–704**
- template function, **1008**
- template prefix, **1008**, **1013**, **1015**
- templates
  - binary trees, **1277–1283**
  - class, **1014–1023**
  - defining, **1013**, **1014**
  - dynamic queue, **1211–1214**
  - dynamic stack, **1187–1192**
  - function, **1008–1013**
  - linked list, **1141–1153**
  - prefixes, **1008**, **1013**
  - specialized, **1023**
  - static queue, **1198–1202**
  - static queues, **1203–1206**
  - static stack, **1176–1181**
  - type parameter, **1008**
- ternary operators, **63**, **201**
- text editor, **11**
- text files
  - described, **270**

- numeric data from, **280–281**
- `this` pointer, **837, 839–840**
- throwing an exception, **531, 990**
- `throw` key word, **990, 1005**
- throw point, **990**
- `time` library function, **129**
- `tolower` library function, **561**
- top-down design, **20**
- `to_string` function, **581**
- `toupper` library function, **561**
- Towers of Hanoi, **1243–1246**
- trailing `else`, **181**
- traversing
  - binary tree, **1264–1267**
  - linked list, **1131–1133**
- true values, **152, 154–155, 162–163**
- truth, **154–156, 162–163**
- try block, **990**
- try/catch construct, **990–992**
- `try` key word, **990**
- two-dimensional arrays, **424–431**
  - initializing, **427–428**
  - passing, to functions, **428–429**
  - summing columns, **431**
  - summing elements of, **430**
  - summing rows, **430–431**
- type cast expression, **103**
- type casting, **103–106**

- type coercion, **100**
- type conversion, **100–101**
- type parameters, **1008–1010, 1012**

# U

- UML, see **Unified Modeling Language**
- unary predicate, **1111**
- unary operator, **63**
- underflow, **102–103**
- Unified Modeling Language (UML), **792–794, 870–871**
  - access specification, showing, **793**
  - aggregation, showing, **870–871**
  - class diagram, **792–794**
  - constructors, showing, **794**
  - destructors, showing, **794**
  - parameter notation, **793–794**
- `unique_ptr`, **541–544**
- United Cause, case study, **544–549**
- `unordered_multimap` class, **1078**
- `unordered_multiset` class, **1085**
- `unordered_set` class, **1085**
- `unsigned int`, **44, 45**
- `unsigned long`, **44, 45**
- `unsigned short`, **44, 45**
- unwinding the stack, **1005**
- update expression (`for` loop), **252, 256, 257–258**
  - multiple statements in, **257–258**
- uppercase conversion, character, **561–563**

- USB drives, [6](#)
- user-controlled loops, [248](#), [256–257](#)
- user-specified filenames, [286–287](#)
- utility programs, [7](#)

# V

- value, passing by, [647](#)
- value-returning functions, [330–338](#)
  - calling, [332–338](#)
  - defining, [330–331](#)
- variable declaration, [17](#)
- variable definitions, [17](#), [38](#)
- variables, [16–17](#)
  - control, [239](#)
  - flag, [183–184](#)
  - global, [342–344](#)
  - instance, [817–824](#)
  - integer, [44](#), [184](#)
  - local, [340–342](#), [347–348](#), [348–351](#)
  - loop control, [239](#)
  - names, [43](#)
  - overflow and underflow, [102–103](#)
  - with same name, [215–216](#), [347–348](#)
  - static member, [818–824](#)
  - structure, [617–618](#), [621](#)
  - `capacity` member function, [448](#)
  - `clear` member function, [445](#), [448](#)
  - compared to linked list, [1123](#)
  - defining, [436–437](#)



- `empty` member function, **446–447, 448**
- initialization list, with C++ **11, 437**
- `at` member function, **448**
- `pop_back` member function, **448**
- `push_back` member function, **441–442, 448**
- range-based `for` loop, **439–441**
- removing elements from, **444–445**
- `resize` member function, **449**
- `reverse` member function, **448**
- searching and sorting, **495–497**
- `size` member function, **443–444**
- STL, **435–436**
- storing and retrieving values in, **437–439**
- `swap` member function, **449**
- `vector`, **1040**
  - basic operations, **1043–1044**
  - `capacity()` member function, **1052–1053**
  - defining, **1043–1044**
  - definition statements, **1040–1041**
  - `emplace()` member function, **1050–1052**
  - `emplace_back()` member function, **1050–1052**
  - `insert` member function, **1045–1047**
  - iterators usage, **1045**
  - `max_size()` member function, **1052–1053**
  - member functions, **1041–1043**
  - `reserve()` member function, **1052–1053**
  - `shrink_to_fit()` member function, **1052–1053**

- storing values in, **1048–1050**
- virtual destructors, **947–963, 958–963**
- virtual functions
  - and polymorphism, **953–955**
  - pure, **963–967**
- `virtual` key word, 949
- virtual member functions, **947–963**
- Visual Basic, **11**
- `void` function, **307**
- volatile memory, RAM as, **5**

# W

- `weak_ptr`, [541](#)
- Web browsers, [269](#)
- `while` loops, [236–242](#), [265](#)
  - input validation with, [243–245](#)
  - logic of, [237–239](#)
  - as pretest loop, [239](#)
  - programming style, [241–242](#)
- whitespace characters, [120](#)
- whole-part relationship, [868](#)
- word processors, [269](#), [665](#)
- `write` member function, file stream objects, [689](#)

# Z

- zero(es)
  - division by, [169](#), [989–990](#)
  - trailing, [117](#), [118](#)

# Credits

Cover Image © Roman Samokhin/123RF

**Figure 1-2** a pg. 3 © iko/Shutterstock

**Figure 1-2** b pg. 3 © Nikita Rogul/Shutterstock

**Figure 1-2** c pg. 3 © Feng Yu/Shutterstock

**Figure 1-2** d pg. 3 © Chiyacat/Shutterstock

**Figure 1-2** e pg. 3 © Eikostas/Shutterstock

**Figure 1-2** f pg. 3 © tkemot/Shutterstock

**Figure 1-2** g pg. 3 © Vitaly Korovin/Shutterstock

**Figure 1-2** h pg. 3 © Lusoimages/Shutterstock

**Figure 1-2** i pg. 3 © jocic/Shutterstock

**Figure 1-2** j pg. 3 © Best Pictures here/Shutterstock


**Figure 1-2** k pg. 3 © Peter Guess/Shutterstock


**Figure 1-2**  pg. 3 © Aquila/Shutterstock


**Figure 1-2** m pg. 3 © Andre Nitsievsky/Shutterstock


**Figure 1-3**  pg. 4 © U.S. Army Center of Military History

**Figure 1-4**  pg. 4 © Creativa/Shutterstock

**Chapter 1**  Microsoft screenshots - SEE MICROSOFT AGREEMENT FOR FULL CREDIT LINE.

**Chapter 2**  Microsoft screenshots - SEE MICROSOFT AGREEMENT FOR FULL CREDIT LINE.

**Chapter 5**  Microsoft screenshots - SEE MICROSOFT AGREEMENT FOR FULL CREDIT LINE.

**Chapter 17**  Microsoft screenshots - SEE MICROSOFT AGREEMENT FOR FULL CREDIT LINE.

MICROSOFT AND/OR ITS RESPECTIVE SUPPLIERS MAKE NO REPRESENTATIONS ABOUT THE SUITABILITY OF THE INFORMATION CONTAINED IN THE DOCUMENTS AND RELATED GRAPHICS PUBLISHED AS PART OF THE SERVICES FOR ANY PURPOSE. ALL SUCH DOCUMENTS AND RELATED GRAPHICS ARE PROVIDED “AS IS” WITHOUT WARRANTY OF ANY KIND. MICROSOFT AND/OR ITS RESPECTIVE SUPPLIERS HEREBY DISCLAIM ALL WARRANTIES AND CONDITIONS WITH REGARD

TO THIS INFORMATION, INCLUDING ALL WARRANTIES AND CONDITIONS OF MERCHANTABILITY, WHETHER EXPRESS, IMPLIED OR STATUTORY, FITNESS FOR A PARTICULAR PURPOSE, TITLE AND NON-INFRINGEMENT. IN NO EVENT SHALL MICROSOFT AND/OR ITS RESPECTIVE SUPPLIERS BE LIABLE FOR ANY SPECIAL, INDIRECT OR CONSEQUENTIAL DAMAGES OR ANY DAMAGES WHATSOEVER RESULTING FROM LOSS OF USE, DATA OR PROFITS, WHETHER IN AN ACTION OF CONTRACT, NEGLIGENCE OR OTHER TORTIOUS ACTION, ARISING OUT OF OR IN CONNECTION WITH THE USE OR PERFORMANCE OF INFORMATION AVAILABLE FROM THE SERVICES. THE DOCUMENTS AND RELATED GRAPHICS CONTAINED HEREIN COULD INCLUDE TECHNICAL INACCURACIES OR TYPOGRAPHICAL ERRORS. CHANGES ARE PERIODICALLY ADDED TO THE INFORMATION HEREIN. MICROSOFT AND/OR ITS RESPECTIVE SUPPLIERS MAY MAKE IMPROVEMENTS AND/OR CHANGES IN THE PRODUCT(S) AND/OR THE PROGRAM(S) DESCRIBED HEREIN AT ANY TIME. PARTIAL SCREEN SHOTS MAY BE VIEWED IN FULL WITHIN THE SOFTWARE VERSION SPECIFIED.

# Contents

**Starting Out with C++ From Control Structures Through**

**1. Objects**

**Starting Out with C++ From Control Structures Through**

**2. Objects**

**3. Contents at a Glance**

**4. Contents**

**5. Preface**

**A. Changes in the Ninth Edition**

**B. Organization of the Text**

**C. Brief Overview of Each Chapter**

**D. Features of the Text**

**E. Supplements**

**F. Which Gaddis C++ book is right for you?**

**G. About the Author**

**6. Chapter 1 Introduction to Computers and Programming**

**A. Topics**

**B. 1.1 Why Program?**

**C. 1.2 Computer Systems: Hardware and Software**

**1. Hardware**

**a. The CPU**

**b. Main Memory**

**c. Secondary Storage**

**d. Input Devices**



- e. **Output Devices**
- 2. **Software**
  - a. **System Software**
  - b. **Application Software**
    - a. **Checkpoint**
- D. **1.3 Programs and Programming Languages**
  - 1. **What Is a Program?**
  - 2. **Programming Languages**
  - 3. **Source Code, Object Code, and Executable Code**
    - a. **Checkpoint**
- E. **1.4 What Is a Program Made of?**
  - 1. **Language Elements**
    - a. **Key Words (Reserved Words)**
    - b. **Programmer-Defined Identifiers**
    - c. **Operators**
    - d. **Punctuation**
  - 2. **Lines and Statements**
  - 3. **Variables**
  - 4. **Variable Definitions**
- F. **1.5 Input, Processing, and Output**
  - 1. **Checkpoint**
- G. **1.6 The Programming Process**
  - 1. **Designing and Creating a Program**
  - 2. **What Is Software Engineering?**

## H. 1.7 Procedural and Object-Oriented Programming

### 1. Checkpoint

## I. Review Questions and Exercises

1. Short Answer
2. Fill-in-the-Blank
3. Algorithm Workbench
4. Predict the Result
5. Find the Error

## 7. Chapter 2 Introduction to C++

### A. Topics

### B. 2.1 The Parts of a C++ Program

#### 1. Checkpoint

### C. 2.2 The `cout` Object

### D. 2.3 The `#include` Directive

#### 1. Checkpoint

### E. 2.4 Variables, Literals, and Assignment Statements

1. Sometimes a Number Isn't a Number
2. Literals
  - a. Checkpoint

### F. 2.5 Identifiers

#### 1. Legal Identifiers

### G. 2.6 Integer Data Types

#### 1. Integer and Long Integer Literals

## **If You Plan to Continue in Computer Science:**

### **2. Hexadecimal and Octal Literals**

#### **a. Checkpoint**

### **H. 2.7 The `char` Data Type**

#### **The Difference between String Literals and Character**

##### **1. Literals**

### **I. 2.8 The C++ `string` Class**

#### **1. Using the `string` Class**

##### **a. Checkpoint**

### **J. 2.9 Floating-Point Data Types**

#### **1. Floating-Point Literals**

#### **2. Assigning Floating-Point Values to Integer Variables**

### **K. 2.10 The `bool` Data Type**

### **L. 2.11 Determining the Size of a Data Type**

#### **1. Checkpoint**

### **M. 2.12 More about Variable Assignments and Initialization**

#### **1. Declaring Variables with the `auto` Key Word**

#### **2. Alternative Forms of Variable Initialization**

### **N. 2.13 Scope**

### **O. 2.14 Arithmetic Operators**

#### **1. Integer Division**

##### **a. Checkpoint**

**P. 2.15 Comments**

- 1. Single-Line Comments**
- 2. Multi-Line Comments**

**Q. 2.16 Named Constants**

- 1. Checkpoint**

**R. 2.17 Programming Style**

**S. Review Questions and Exercises**

- 1. Short Answer**
- 2. Multiple Choice**
- 3. True or False**
- 4. Algorithm Workbench**
- 5. Find the Error**

**T. Programming Challenges**

**8. Chapter 3 Expressions and Interactivity**

**A. Topics**

**B. 3.1 The `cin` Object**

- 1. Entering Multiple Values**
  - a. Checkpoint**

**C. 3.2 Mathematical Expressions**

- 1. Operator Precedence**
- 2. Associativity**
- 3. Grouping with Parentheses**
  - Converting Algebraic Expressions to Programming**
- 4. Statements**

- 5. **No Exponents Please!**
  - a. **Checkpoint**
- D. **3.3 When You Mix Apples and Oranges: Type Conversion**
  - 1. **Integer Division**
- E. **3.4 Overflow and Underflow**
- F. **3.5 Type Casting**
  - 1. **Checkpoint**
- G. **3.6 Multiple Assignment and Combined Assignment**
  - 1. **Combined Assignment Operators**
    - a. **Checkpoint**
- H. **3.7 Formatting Output**
  - 1. **The `setprecision` Manipulator**
  - 2. **The `fixed` Manipulator**
  - 3. **The `showpoint` Manipulator**
  - 4. **The `left` and `right` Manipulators**
    - a. **Checkpoint**
- I. **3.8 Working with Characters and `string` Objects**
  - 1. **Inputting a Character**
  - 2. **Using `cin.get`**
  - 3. **Mixing `cin >>` and `cin.get`**
  - 4. **Using `cin.ignore`**
  - 5. **`string` Member Functions and Operators**

## J. 3.9 More Mathematical Library Functions

### 1. Random Numbers

#### a. Checkpoint

## K. 3.10 Focus on Debugging: Hand Tracing a Program

## L. 3.11 Focus on Problem Solving: A Case Study

### 1. Variables

### 2. Program Design

### 3. Calculations

### 4. The Program

## M. Review Questions and Exercises

### 1. Short Answer

### 2. Fill-in-the-Blank

### 3. Algorithm Workbench

### 4. Find the Errors

### 5. Predict the Output

## N. Programming Challenges

## 9. Chapter 4 Making Decisions

### A. Topics

### B. 4.1 Relational Operators

#### 1. The Value of a Relationship

#### 2. What Is Truth?

##### a. Checkpoint

### C. 4.2 The `if` Statement

#### 1. Be Careful with Semicolons

2. **Programming Style and the `if` Statement**
  3. **Comparing Floating-Point Numbers**
  4. **And Now Back to Truth**
  5. **Don't Confuse `==` with `=`**
    - a. **Checkpoint**
- D. **4.3 Expanding the `if` Statement**
1. **Don't Forget the Braces!**
    - a. **Checkpoint**
- E. **4.4 The `if/else` Statement**
1. **Checkpoint**
- F. **4.5 Nested `if` Statements**
1. **Programming Style and Nested Decision Structures**
  2. **Testing a Series of Conditions**
    - a. **Checkpoint**
- G. **4.6 The `if/else if` Statement**
1. **Using the Trailing `else` to Catch Errors**

The `if/else if` Statement Compared to a Nested
  2. **Decision Structure**
    - a. **Checkpoint**
- H. **4.7 Flags**
1. **Integer Flags**
- I. **4.8 Logical Operators**

1. The `&&` Operator
  2. The `||` Operator
  3. The `!` Operator
  4. Precedence and Associativity of Logical Operators
- J. 4.9 Checking Numeric Ranges with Logical Operators
1. Checkpoint
- K. 4.10 Menus
- 4.11 Focus on Software Engineering: Validating User
- L. Input
- M. 4.12 Comparing Characters and Strings
1. Comparing Characters
  2. Comparing `string` Objects
    - a. Checkpoint
- N. 4.13 The Conditional Operator
1. Using the Value of a Conditional Expression
    - a. Checkpoint
- O. 4.14 The `switch` Statement
1. Using `switch` in Menu Systems
    - a. Checkpoint
- P. 4.15 More about Blocks and Variable Scope
1. Variables with the Same Name
- Q. Review Questions and Exercises
1. Short Answer



2. **Fill-in-the-Blank**
  3. **Algorithm Workbench**
  4. **True or False**
  5. **Find the Errors**
- R. **Programming Challenges**
10. **Chapter 5 Loops and Files**
- A. **Topics**
  - B. **5.1 The Increment and Decrement Operators**
    1. **The Difference between Postfix and Prefix Modes**
    2. **Using `++` and `--` in Mathematical Expressions**
    3. **Using `++` and `--` in Relational Expressions**
      - a. **Checkpoint**
  - C. **5.2 Introduction to Loops: The `while` Loop**
    1. **The `while` Loop**
    2. **The `while` Loop Is a Pretest Loop**
    3. **Infinite Loops**
    4. **Don't Forget the Braces with a Block of Statements**
    5. **Programming Style and the `while` Loop**
  - D. **5.3 Using the `while` Loop for Input Validation**
    1. **Checkpoint**
  - E. **5.4 Counters**
  - F. **5.5 The `do-while` Loop**
    1. **Using `do-while` with Menus**
      - a. **Checkpoint**

## G. 5.6 The `for` Loop

1. Using the `for` Loop instead of `while` or `do-while`
2. The `for` Loop Is a Pretest Loop
  - Avoid Modifying the Counter Variable in the Body of
3. the `for` Loop
4. Other Forms of the Update Expression
  - Defining a Variable in the `for` Loop's Initialization
5. Expression
6. Creating a User-Controlled `for` Loop
  - Using Multiple Statements in the Initialization and
7. Update Expressions
8. Omitting the `for` Loop's Expressions
  - a. Checkpoint

## H. 5.7 Keeping a Running Total

- I. 5.8 Sentinels
  1. Checkpoint

## 5.9 Focus on Software Engineering: Deciding Which Loop

### J. to Use

## K. 5.10 Nested Loops

## L. 5.11 Using Files for Data Storage

1. Types of Files
2. File Access Methods
3. Filenames and File Stream Objects
4. Setting Up a Program for File Input/Output
5. Creating a File Object and Opening a File
6. Closing a File

7. **Writing Data to a File**
8. **Reading Data from a File**
9. **The Read Position**
10. **Reading Numeric Data from a Text File**
11. **Using Loops to Process Files**
12. **Detecting the End of the File**
13. **Testing for File Open Errors**
14. **Letting the User Specify a Filename**
  - Using the `c_str` Member Function in Older Versions of
15. **C++**
  - a. **Checkpoint**
- M. **5.12 Optional Topics: Breaking and Continuing a Loop**
  1. **Using break in a Nested Loop**
  2. **The `continue` Statement**
- N. **Review Questions and Exercises**
  1. **Short Answer**
  2. **Fill-in-the-Blank**
  3. **Algorithm Workbench**
  4. **True or False**
  5. **Find the Errors**
- O. **Programming Challenges**
11. **Chapter 6 Functions**
  - A. **Topics**
    - 6.1 **Focus on Software Engineering: Modular**
  - B. **Programming**
  - C. **6.2 Defining and Calling Functions**

1. `void` Functions
  2. Calling a Function
    - a. Checkpoint
- D. 6.3 Function Prototypes
- E. 6.4 Sending Data into a Function
- F. 6.5 Passing Data by Value
- 6.6 Focus on Software Engineering: Using Functions in a
- G. Menu-Driven Program
1. Checkpoint
- H. 6.7 The `return` Statement
- I. 6.8 Returning a Value from a Function
    1. Defining a Value-Returning Function
    2. Calling a Value-Returning Function
- J. 6.9 Returning a Boolean Value
1. Checkpoint
- K. 6.10 Local and Global Variables
1. Local Variables
  2. Local Variable Lifetime
  3. Initializing Local Variables with Parameter Values
  4. Global Variables
  5. Global Constants
  6. Local and Global Variables with the Same Name
- L. 6.11 Static Local Variables
1. Checkpoint

- M. **6.12 Default Arguments**
- N. **6.13 Using Reference Variables as Parameters**
  - 1. **Checkpoint**
  
- O. **6.14 Overloading Functions**
- P. **6.15 The `exit()` Function**
  - 1. **Checkpoint**
  
- Q. **6.16 Stubs and Drivers**
- R. **Review Questions and Exercises**
  - 1. **Short Answer**
  - 2. **Fill-in-the-Blank**
  - 3. **Algorithm Workbench**
  - 4. **True or False**
  - 5. **Find the Errors**
  
- S. **Programming Challenges**
- T. **Group Project**
- 12. **Chapter 7 Arrays and Vectors**
  - A. **Topics**
  - B. **7.1 Arrays Hold Multiple Values**
    - 1. **Memory Requirements of Arrays**
  
  - C. **7.2 Accessing Array Elements**
    - 1. **Inputting and Outputting Array Contents**
    - 2. **Array Initialization**
    - 3. **Partial Array Initialization**
    - 4. **Implicit Array Sizing**

5. **Reading Data from a File into an Array**
  6. **Writing the Contents of an Array to a File**
- D. **7.3 No Bounds Checking in C++**
1. **Watch for Off-by-One Errors**
    - a. **Checkpoint**
- E. **7.4 The Range-Based `for` Loop**
1. **Modifying an Array with a Range-Based `for` Loop**  
**The Range-Based `for` Loop versus the Regular `for`**
  2. **Loop**
- F. **7.5 Processing Array Contents**
1. **Thou Shall Not Assign**
  2. **Printing the Contents of an Array**
  3. **Summing the Values in a Numeric Array**
  4. **Getting the Average of the Values in a Numeric Array**  
**Finding the Highest and Lowest Values in a Numeric**
  5. **Array**
  6. **Partially Filled Arrays**
  7. **Comparing Arrays**
- G. **7.6 Focus on Software Engineering: Using Parallel Arrays**
1. **Checkpoint**
- H. **7.7 Arrays as Function Arguments**
1. **Using `const` Array Parameters**
  2. **Some Useful Array Functions**
    - a. **Checkpoint**

## I. 7.8 Two-Dimensional Arrays

1. Passing Two-Dimensional Arrays to Functions
2. Summing All the Elements of a Two-Dimensional Array
3. Summing the Rows of a Two-Dimensional Array
4. Summing the Columns of a Two-Dimensional Array

## J. 7.9 Arrays with Three or More Dimensions

1. Checkpoint

## 7.10 Focus on Problem Solving and Program Design: A

## K. Case Study

## L. 7.11 Introduction to the STL `vector`

1. Defining a `vector`
2. Using an Initialization List with a `vector` in C++ 11
3. Storing and Retrieving Values in a `vector`  
Using the Range-Based `for` Loop with a `vector` in
4. C++ 11
  - a. Using the `push_back` Member Function
5. Determining the Size of a `vector`
6. Removing Elements from a `vector`
7. Clearing a `vector`
8. Detecting an Empty `vector`
9. Summary of `vector` Member Functions
  - a. Checkpoint

## M. Review Questions and Exercises

1. **Short Answer**
  2. **Fill-in-the-Blank**
  3. **Algorithm Workbench**
  4. **True or False**
  5. **Find the Errors**
- N. **Programming Challenges**
- O. **Group Project**
13. **Chapter 8 Searching and Sorting Arrays**
- A. **Topics**
- 8.1 Focus on Software Engineering: Introduction to**
- B. **Search Algorithms**
1. **The Linear Search**
  2. **Inefficiency of the Linear Search**
  3. **The Binary Search**
  4. **The Efficiency of the Binary Search**
- 8.2 Focus on Problem Solving and Program Design: A**
- C. **Case Study**
1. **Variables**
  2. **Modules**
  3. **Function** `main`
  4. **The** `getProdNum` **Function**
  5. **The** `binarySearch` **Function**
  6. **The** `displayProd` **Function**
  7. **The Entire Program**
    - a. **Checkpoint**



## 8.3 Focus on Software Engineering: Introduction to

### D. Sorting Algorithms

1. Sorting Algorithms
2. The Bubble Sort
3. Swapping Array Elements
4. The Selection Sort Algorithm

## 8.4 Focus on Problem Solving and Program Design: A

### E. Case Study

1. Variables
2. Modules
3. Function `main`
4. The `calcSales` Function
5. The `dualSort` Function
6. The Overloaded `swap` Functions
7. The `showOrder` Function
8. The `showTotals` Function
9. The Entire Program

## 8.5 Sorting and Searching `vector`s (Continued from

### F. Section 7.11)

### G. Review Questions and Exercises

1. Short Answer
2. Fill-in-the-Blank
3. True or False

### H. Programming Challenges

## 14. Chapter 9 Pointers

- A. **Topics**
- B. **9.1 Getting the Address of a Variable**
- C. **9.2 Pointer Variables**
  - 1. **Creating and Using Pointer Variables**
  
- D. **9.3 The Relationship between Arrays and Pointers**
- E. **9.4 Pointer Arithmetic**
- F. **9.5 Initializing Pointers**
  - 1. **Checkpoint**
  
- G. **9.6 Comparing Pointers**
- H. **9.7 Pointers as Function Parameters**
  - 1. **Pointers to Constants**
    - Passing a Nonconstant Argument into a Pointer to**
      - a. **a Constant**
  - 2. **Constant Pointers**
  - 3. **Constant Pointers to Constants**
  
- I. **9.8 Dynamic Memory Allocation**
- J. **9.9 Returning Pointers from Functions**
  - 1. **Checkpoint**
  
- K. **9.10 Using Smart Pointers to Avoid Memory Leaks**
  - 9.11 Focus on Problem Solving and Program Design: A**
- L. **Case Study**
  - 1. **Variables**
  - 2. **Programming Strategy**

3. **Functions**
  4. **Function** `main`
  5. **The** `arrSelectSort` **Function**
  6. **The** `showArrPtr` **Function**
  7. **The** `showArray` **Function**
  8. **The Entire Program**
- M. **Review Questions and Exercises**
1. **Short Answer**
  2. **Fill-in-the-Blank**
  3. **Algorithm Workbench**
  4. **True or False**
  5. **Find the Error**

N. **Programming Challenges**

**Chapter 10 Characters, C-Strings, and More about the**

15. `string` **Class**
  - A. **Topics**
  - B. **10.1 Character Testing**
  - C. **10.2 Character Case Conversion**
    1. **Checkpoint**
  - D. **10.3 C-Strings**
    1. **More about String Literals**
    2. **C-Strings Stored in Arrays**
  - E. **10.4 Library Functions for Working with C-Strings**
    1. **The** `strlen` **Function**
    2. **The** `strcat` **Function**

3. The `strcpy` Function
4. The `strncat` and `strncpy` Functions
5. The `strstr` Function
6. The `strcmp` Function
7. Using `!` with `strcmp`
8. Sorting Strings

- a. Checkpoint

## F. 10.5 String/Numeric Conversion Functions

1. The `string` to Number Functions
2. The `to_string` Function

- a. Checkpoint

## 10.6 Focus on Software Engineering: Writing Your Own C-

### G. String-Handling Functions

1. Using Pointers to Pass C-String Arguments
- a. Checkpoint

### H. 10.7 More about the C++ `string` Class

1. Using the `string` Class
2. Reading a Line of Input into a `string` Object
3. Comparing and Sorting `string` Objects
4. Other Ways to Define `string` Objects
5. Using `string` Class Member Functions

## 10.8 Focus on Problem Solving and Program Design: A

- I. Case Study
- J. Review Questions and Exercises

1. **Short Answer**
  2. **Fill-in-the-Blank**
  3. **Algorithm Workbench**
  4. **True or False**
  5. **Find the Errors**
- K. **Programming Challenges**
16. **Chapter 11 Structured Data**
- A. **Topics**
  - B. **11.1 Abstract Data Types**
    1. **Abstraction**
    2. **Data Types**
    3. **Abstract Data Types**
  - C. **11.2 Structures**
  - D. **11.3 Accessing Structure Members**
    1. **Comparing Structure Variables**
  - E. **11.4 Initializing a Structure**
    1. **Checkpoint**
  - F. **11.5 Arrays of Structures**
    1. **Initializing a Structure Array**
  - G. **11.6 Focus on Software Engineering: Nested Structures**
    1. **Checkpoint**
  - H. **11.7 Structures as Function Arguments**
    1. **Constant Reference Parameters**



3. **Algorithm Workbench**

4. **True or False**

5. **Find the Errors**

N. **Programming Challenges**

17. **Chapter 12 Advanced File Operations**

A. **Topics**

B. **12.1 File Operations**

1. **Using the `fstream` Data Type**

2. **File Open Modes with `ifstream` and `ofstream` Objects**

3. **Checking for a File's Existence Before Opening It  
Opening a File with the File Stream Object Definition**

4. **Statement**

a. **Checkpoint**

C. **12.2 File Output Formatting**

D. **12.3 Passing File Stream Objects to Functions**

E. **12.4 More Detailed Error Testing**

F. **12.5 Member Functions for Reading and Writing Files**

1. **The `getline` Function**

2. **The `get` Member Function**

3. **The `put` Member Function**

a. **Checkpoint**

**12.6 Focus on Software Engineering: Working with**

G. **Multiple Files**

H. **12.7 Binary Files**

1. **The `write` and `read` Member Functions**

2. **Writing Data other than `char` to Binary Files**

- I. **12.8 Creating Records with Structures**
- J. **12.9 Random-Access Files**
  - 1. The `seekp` and `seekg` Member Functions
  - 2. The `tellp` and `tellg` Member Functions
  - 3. Rewinding a Sequential-Access File with `seekg`
  
- K. **12.10 Opening a File for Both Input and Output**
  - 1. Checkpoint
  
- L. **Review Questions and Exercises**
  - 1. Short Answer
  - 2. Fill-in-the-Blank
  - 3. Algorithm Workbench
  - 4. True or False
  - 5. Find the Error
  
- M. **Programming Challenges**
- N. **Group Project**
- 18. **Chapter 13 Introduction to Classes**
  - A. **Topics**
  - B. **13.1 Procedural and Object-Oriented Programming**
    - 1. Object Reusability
    - 2. Classes and Objects
    - 3. Using a Class You Already Know
  
  - C. **13.2 Introduction to Classes**
    - 1. Access Specifiers
    - 2. Public Member Functions



3. Using `const` with Member Functions
  4. Placement of `public` and `private` Members
  5. Defining Member Functions
  6. Accessors and Mutators
  7. Using `const` with Accessors
  8. The Importance of Data Hiding
- D. **13.3 Defining an Instance of a Class**
1. Accessing an Object's Members
  2. A Class Demonstration Program
  3. Avoiding Stale Data
  4. Pointers to Objects
  5. Using Smart Pointers to Allocate Objects
    - a. Checkpoint
- E. **13.4 Why Have Private Members?**
- 13.5 Focus on Software Engineering: Separating Class**
- F. **Specification from Implementation**
- G. **13.6 Inline Member Functions**
1. Inline Functions and Performance
    - a. Checkpoint
- H. **13.7 Constructors**
1. Using Member Initialization Lists
  2. In-Place Member Initialization
  3. The Default Constructor
    - Default Constructors and Dynamically Allocated
  4. Objects

- I. **13.8 Passing Arguments to Constructors**
  - 1. **Using Default Arguments with Constructors**
  - 2. **More about the Default Constructor**
    - a. **Classes with No Default Constructor**
  
- J. **13.9 Destructors**
  - 1. **Destructors and Dynamically Allocated Class Objects**
    - a. **Checkpoint**
  
- K. **13.10 Overloading Constructors**
  - 1. **Constructor Delegation**
  - 2. **Only One Default Constructor and One Destructor**
  - 3. **Other Overloaded Member Functions**
  
- L. **13.11 Private Member Functions**
- M. **13.12 Arrays of Objects**
  - 1. **Accessing Members of Objects in an Array**
    - a. **Checkpoint**
  
- 13.13 Focus on Problem Solving and Program Design: An**
- N. **OOP Case Study**
  - 1. **Private Member Variables**
  - 2. **Public Member Functions**
  - 3. **The Class Declaration**
  - 4. **The `withdraw` Member Function**
  - 5. **The Class's Interface**
  - 6. **Implementing the Class**

### **13.14 Focus on Object-Oriented Programming:**

#### **O. Simulating Dice with Objects**

### **13.15 Focus on Object-Oriented Design: The Unified**

#### **P. Modeling Language (UML)**

- 1. Showing Access Specification in UML Diagrams**
- 2. Data Type and Parameter Notation in UML Diagrams**  
**Showing Constructors and Destructors in a UML**
- 3. Diagram**

### **13.16 Focus on Object-Oriented Design: Finding the**

#### **Q. Classes and Their Responsibilities**

- 1. Finding the Classes**
- 2. Write a Description of the Problem Domain**
- 3. Identify All of the Nouns**
- 4. Refine the List of Nouns**
- 5. Identifying a Class's Responsibilities**
  - a. The `Customer` class**
  - b. The `Car` Class**
    - a. The `ServiceQuote` Class**
- 6. This Is Only the Beginning**
  - a. Checkpoint**

#### **R. Review Questions and Exercises**

- 1. Short Answer**
- 2. Fill-in-the-Blank**
- 3. Algorithm Workbench**
- 4. True or False**

- 5. Find the Errors
- S. Programming Challenges
- T. Group Project
- 19. Chapter 14 More about Classes
  - A. Topics
  - B. 14.1 Instance and Static Members
    - 1. Instance Variables
    - 2. Static Members
    - 3. Static Member Variables
    - 4. Static Member Functions
  - C. 14.2 Friends of Classes
    - 1. Checkpoint
  - D. 14.3 Memberwise Assignment
  - E. 14.4 Copy Constructors
    - 1. Using `const` Parameters in Copy Constructors
    - 2. Copy Constructors and Function Parameters
    - 3. The Default Copy Constructor
      - a. Checkpoint
  - F. 14.5 Operator Overloading
    - 1. The `this` Pointer
    - 2. Overloading the = Operator
    - 3. Checking for Self-Assignment
    - 4. The = Operator's Return Value
    - 5. Copy Assignment
    - 6. Some General Issues of Operator Overloading

7. **Overloading Math Operators**
8. **Overloading the Prefix ++ Operator**
9. **Overloading the Postfix ++ Operator**
  - a. **Checkpoint**
  
10. **Overloading Relational Operators**
11. **Overloading the << and >> Operators**
12. **Overloading the [ ] Operator**
  - a. **Checkpoint**
  
- G. **14.6 Object Conversion**
  1. **Checkpoint**
  
- H. **14.7 Aggregation**
  - Using Member Initialization Lists with Aggregate**
  1. **Classes**
  2. **Aggregation in UML Diagrams**
  
- 14.8 Focus on Object-Oriented Design: Class**
- I. **Collaborations**
  1. **Determining Class Collaborations with CRC Cards**
    - a. **Checkpoint**
  
- 14.9 Focus on Object-Oriented Programming: Simulating**
- J. **the Game of Cho-Han**
- K. **14.10 Rvalue References and Move Semantics**
  1. **Lvalues and Rvalues**
  2. **Rvalue References**
  3. **Move Semantics**

4. **When to Implement Move Semantics in a Class**
5. **Default Operations Provided by the Compiler**

**L. Review Questions and Exercises**

1. **Short Answer**
2. **Fill-in-the-Blank**
3. **Algorithm Workbench**
4. **True or False**
5. **Find the Errors**

**M. Programming Challenges**

**Chapter 15 Inheritance, Polymorphism, and Virtual**

**20. Functions**

**A. Topics**

**B. 15.1 What Is Inheritance?**

1. **Generalization and Specialization**
2. **Inheritance and the “Is a” Relationship**
  - a. **Checkpoint**

**C. 15.2 Protected Members and Class Access**

1. **More about Base Class Access Specification**
  - a. **Checkpoint**

**15.3 Constructors and Destructors in Base and Derived**

**D. Classes**

1. **Passing Arguments to Base Class Constructors**
2. **Constructor Inheritance**
  - a. **Checkpoint**

- E. **15.4 Redefining Base Class Functions**
- F. **15.5 Class Hierarchies**
- G. **15.6 Polymorphism and Virtual Member Functions**
  - 1. **Polymorphism Requires References or Pointers**
  - 2. **Base Class Pointers**
    - Base Class Pointers and References Know Only about**
  - 3. **Base Class Members**
  - 4. **The “Is-a” Relationship Does Not Work in Reverse**
  - 5. **Redefining versus Overriding**
  - 6. **Virtual Destructors**
  - 7. **C++ 11’s `override` and `final` Key Words**
  - 8. **Preventing a Member Function from Being Overridden**
- H. **15.7 Abstract Base Classes and Pure Virtual Functions**
  - 1. **Checkpoint**
- I. **15.8 Multiple Inheritance**
  - 1. **Checkpoint**
- J. **Review Questions and Exercises**
  - 1. **Short Answer**
  - 2. **Fill-in-the-Blank**
  - 3. **Algorithm Workbench**
  - 4. **True or False**
  - 5. **Find the Errors**
- K. **Programming Challenges**
- L. **Group Project**

## 21. Chapter 16 Exceptions and Templates

### A. Topics

### B. 16.1 Exceptions

1. Throwing an Exception
2. Handling an Exception
3. What if an Exception Is Not Caught?
4. Object-Oriented Exception Handling with Classes
5. Multiple Exceptions
  - a. Using Exception Handlers to Recover from Errors
  
6. Extracting Data from the Exception Class
7. Unwinding the Stack
8. Rethrowing an Exception
9. Handling the `bad_alloc` Exception
  - a. Checkpoint

### C. 16.2 Function Templates

1. Introduction
2. Using Operators in Function Templates
3. Function Templates with Multiple Types
4. Overloading with Function Templates

### 16.3 Focus on Software Engineering: Where to Start

### D. When Defining Templates

1. Checkpoint

### E. 16.4 Class Templates

1. Defining Objects of the Class Template



2. **Class Templates and Inheritance**

3. **Specialized Templates**

a. **Checkpoint**

F. **Review Questions and Exercises**

1. **Short Answer**

2. **Fill-in-the-Blank**

3. **Algorithm Workbench**

4. **True or False**

5. **Find the Error**

G. **Programming Challenges**

22. **Chapter 17 The Standard Template Library**

A. **Topics**

B. **17.1 Introduction to the Standard Template Library**

C. **17.2 STL Container and Iterator Fundamentals**

1. **Containers**

2. **Introduction to the `array` Class**

3. **Iterators**

a. **Defining an Iterator**

b. **Getting an Iterator from a Container Object**

c. **Using `auto` to Define an Iterator**

d. **Mutable Iterators and `const_iterator`s**

e. **Reverse Iterators**

a. **Checkpoint**

D. **17.3 The `vector` Class**

1. **Review of Basic `vector` Operations**

2. **Using an Iterator with a `vector`**

3. **Inserting New Elements into a `vector` Storing Objects of Your Own Classes as Values in a**
  4. **`vector` Inserting Elements with the `emplace()` and**
  5. **`emplace_back()` Member Functions The `capacity()`, `max_size()`, `shrink_to_fit()`, and**
  6. **`reserve()` Member Functions**
    - a. **Checkpoint**
- E. **17.4 The `map`, `multimap`, and `unordered_map` Classes**
1. **The `map` Class**
  2. **Initializing a Map**
  3. **Adding Elements to an Existing Map**
  4. **Adding Elements with the `insert()` Member Function**
  5. **Adding Elements with the `emplace()` Member Function**
  6. **Retrieving Values from a Map**
  7. **Deleting Elements**
  8. **Iterating Over a Map with the Range-Based `for` Loop**
  9. **Using an Iterator with a Map**
  10. **Storing `vector`s as Values in a `map` Storing Objects of Your Own Classes as Values in a**
  11. **`map`**
  12. **Using an Object of Your Own Class as a Key**
  13. **The `unordered_map` Class**
  14. **The `multimap` Class**
  15. **Adding Elements to a `multimap`**
  16. **Getting the Number of Elements with a Specified Key**
  17. **Retrieving the Elements with a Specified Key**

18. **Deleting Elements from a `multimap`**
19. **The `unordered_multimap` Class**
  - a. **Checkpoint**
- F. **17.5 The `set`, `multiset`, and `unordered_set` Classes**
  1. **Adding Elements to an Existing `set`**
  2. **Iterating Over a `set` with the Range-Based `for` Loop**
  3. **Using an Iterator with a `set`**
  4. **Determining Whether a Value Exists in a `set`**
  5. **Storing Objects of Your Own Classes in a `set`**
  6. **The `multiset` Class**
  7. **The `unordered_set` and `unordered_multiset` Classes**
    - a. **Checkpoint**
- G. **17.6 Algorithms**
  1. **Sorting and Searching Algorithms**
  2. **Detecting Permutations**
  3. **Plugging Your Own Functions into an Algorithm**
  4. **Using the STL to Perform Set Operations**
    - Finding the Union of Sets with the `set_union`**
      - a. **Function**
      - Finding the Intersection of Sets with the**
        - b. **`set_intersection` Function**
        - Finding the Difference of Sets with the**
          - c. **`set_difference` Function**
          - Finding the Symmetric Difference of Sets with the**
            - d. **`set_symmetric_difference` Function**
            - e. **Finding Subsets**

## 17.7 Introduction to Function Objects and Lambda

### H. Expressions

1. Constructing an Anonymous Function Object
2. Predicate Terminology
3. Lambda Expressions
4. Functional Classes in the STL
  - a. Checkpoint

### I. Review Questions and Exercises

1. Short Answer
2. Fill-in-the-Blank
3. True or False
4. Algorithm Workbench
5. Find the Errors

### J. Programming Challenges

## 23. Chapter 18 Linked Lists

### A. Topics

### B. 18.1 Introduction to the Linked List ADT

1. Advantages of Linked Lists over Arrays and `vectors`
2. The Composition of a Linked List
3. Declarations
  - a. Checkpoint

### C. 18.2 Linked List Operations

1. Appending a Node to the List
2. Traversing a Linked List
3. Inserting a Node

- a. **Checkpoint**
    - 4. **Deleting a Node**
    - 5. **Destroying the List**
      - a. **Checkpoint**
  - D. **18.3 A Linked List Template**
    - 1. **Using a Class Node Type**
  - E. **18.4 Variations of the Linked List**
  - F. **18.5 The STL `list` and `forward_list` Containers**
    - 1. **The `list` Container**
    - 2. **The `forward_list` Container**
  - G. **Review Questions and Exercises**
    - 1. **Short Answer**
    - 2. **Fill-in-the-Blank**
    - 3. **Algorithm Workbench**
    - 4. **True or False**
    - 5. **Find the Errors**
  - H. **Programming Challenges**
- 24. **Chapter 19 Stacks and Queues**
  - A. **Topics**
  - B. **19.1 Introduction to the Stack ADT**
    - 1. **Definition**
    - 2. **Applications of Stacks**
    - 3. **Static and Dynamic Stacks**
    - 4. **Stack Operations**
    - 5. **A Static Stack Class**

6. **Implementing Other Stack Operations**
7. **A Static Stack Template**
- C. **19.2 Dynamic Stacks**
  1. **A Dynamic Stack Template**
- D. **19.3 The STL `stack` Container**
  1. **Checkpoint**
- E. **19.4 Introduction to the Queue ADT**
  1. **Definition**
  2. **Application of Queues**
  3. **Static and Dynamic Queues**
  4. **Queue Operations**
  5. **Detecting Full and Empty Queues with Circular Arrays**
  6. **A Static Queue Class**
  7. **A Static Queue Template**
- F. **19.5 Dynamic Queues**
  1. **A Dynamic Queue Template**
- G. **19.6 The STL `deque` and `queue` Containers**
  1. **The `deque` Container**
  2. **The `queue` Container Adapter**
- H. **Review Questions and Exercises**
  1. **Short Answer**
  2. **Fill-in-the-Blank**
  3. **Algorithm Workbench**

#### 4. True or False

#### I. Programming Challenges

### 25. Chapter 20 Recursion

#### A. Topics

#### B. 20.1 Introduction to Recursion

#### C. 20.2 Solving Problems with Recursion

##### Example: Using Recursion to Calculate the Factorial

##### 1. of a Number

##### 2. Example: Using Recursion to Count Characters

##### 3. Direct and Indirect Recursion

##### a. Checkpoint

##### 20.3 Focus on Problem Solving and Program Design: The

#### D. Recursive `gcd` Function

##### 20.4 Focus on Problem Solving and Program Design:

#### E. Solving Recursively Defined Problems

##### 20.5 Focus on Problem Solving and Program Design:

#### F. Recursive Linked List Operations

##### 1. Counting the Nodes in the List

##### 2. Displaying List Nodes in Reverse Order

##### 20.6 Focus on Problem Solving and Program Design: A

#### G. Recursive Binary Search Function

#### H. 20.7 The Towers of Hanoi

##### 20.8 Focus on Problem Solving and Program Design: The

#### I. QuickSort Algorithm

#### J. 20.9 Exhaustive Algorithms

## **20.10 Focus on Software Engineering: Recursion versus**

### **K. Iteration**

### **L. Review Questions and Exercises**

- 1. Short Answer**
- 2. Fill-in-the-Blank**
- 3. Algorithm Workbench**
- 4. Predict the Output**

### **M. Programming Challenges**

## **26. Chapter 21 Binary Trees**

### **A. Topics**

### **B. 21.1 Definition and Applications of Binary Trees**

- 1. Applications of Binary Trees**
  - a. Checkpoint**

### **C. 21.2 Binary Search Tree Operations**

- 1. Creating a Binary Trees**
- 2. Inserting a Node**
- 3. Traversing the Tree**
- 4. Searching the Tree**
- 5. Deleting a Node**
  - a. Checkpoint**

### **D. 21.3 Template Considerations for Binary Search Trees**

### **E. Review Questions and Exercises**

- 1. Short Answer**
- 2. Fill-in-the-Blank**
- 3. Algorithm Workbench**



#### 4. True or False

##### F. Programming Challenges

27. **Appendix A The ASCII Character Set**
28. **Appendix B Operator Precedence and Associativity**
29. **C++ Quick Reference**
30. **Index**
  - A. **Symbols**
  - B. **A**
  - C. **B**
  - D. **C**
  - E. **D**
  - F. **E**
  - G. **F**
  - H. **G**
  - I. **H**
  - J. **I**
  - K. **J**
  - L. **K**
  - M. **L**
  - N. **M**
  - O. **N**
  - P. **O**
  - Q. **P**
  - R. **Q**
  - S. **R**
  - T. **S**
  - U. **T**
  - V. **U**

W. **V**

X. **W**

Y. **Z**

31. **Credits**

# List of Illustrations

1. **Figure P-1 Chapter dependency chart**
2. **Figure 1-1 A word processing program and a presentation program**
3. **Figure 1-2 Typical devices in a computer system**
4. **Figure 1-3 The ENIAC computer**
5. **Figure 1-4 A microprocessor**
6. **Figure 1-5 Organization of a CPU**
7. **Figure 1-6 Memory**
8. **Figure 1-7 Low-level versus high-level languages**
9. **Figure 1-8 Translating a C++ source file to an executable file**
10. **Figure 1-9 An integrated development environment (IDE)**
11. **Figure 1-10 A variable name represents a memory location**
12. **Figure 1-11 Steps for writing a program**
13. **Figure 1-12 Hierarchy chart**
14. **Figure 1-13 Procedures in a program**
15. **Figure 1-14 Objects in a program**
16. **Figure 2-1 A console window**
17. **Figure 2-2 Think of << as an arrow pointing to cout**
18. **Figure 2-3 Individual characters in a string**
19. **Figure 2-4 Characters and their ASCII codes**
20. **Figure 2-5 The string literal "Sebastian"**
21. **Figure 2-6 'A' as a character and "A" as a string**
22. **Figure 2-7 ASCII codes**

23. **Figure 3-1 The << and >> operators**
24. **Figure 3-2 The keyboard buffer**
25. **Figure 3-3 The pow function**
26. **Figure 3-4 The pow function as a “black box”**
27. **Figure 3-5 Contents of the keyboard buffer**
28. **Figure 3-6 cin stops reading at the newline character**
29. **Figure 3-7 Hierarchy chart for the program**
30. **Figure 3-8 Hierarchy chart for the “Get Crate Dimensions” step**
31. **Figure 3-9 Hierarchy chart for the “Calculate Volume, Cost, Customer Charge, and Profit” step**
32. **Figure 3-10 Hierarchy chart for the “Display Calculated Data” step**
33. **Figure 4-1 Sequence structure**
34. **Figure 4-2 Decision structure**
35. **Figure 4-3 Decision structure**
36. **Figure 4-4 if statement logic**
37. **Figure 4-5 Conditionally executed statement**
38. **Figure 4-6 if/else statement logic**
39. **Figure 4-7 Nested decision structures**
40. **Figure 4-8 Proper indentation and alignment**
41. **Figure 4-9 Nested decision structure to determine a grade**
42. **Figure 4-10 Conditional expression**
43. **Figure 4-11 Troubleshooting a bad Wi-Fi connection**
44. **Figure 5-1 Logic of a while loop**
45. **Figure 5-2 Actions of the while loop**
46. **Figure 5-3 Flowchart for the while loop**
47. **Figure 5-4 Flowchart for input validation**

48. **Figure 5-5 Flowchart for a do-while loop**
49. **Figure 5-6 Sequence of events in a for loop**
50. **Figure 5-7 for loop logic**
51. **Figure 5-8 Sequence of events in the for loop**
52. **Figure 5-9 Flowchart for the for loop**
53. **Figure 5-10 Initialization, test, and update expressions**
54. **Figure 5-11 Logic for calculating a running total**
55. **Figure 5-12 Writing data to a file**
56. **Figure 5-13 Reading data from a file**
57. **Figure 5-14 Three files**
58. **Figure 5-15 Contents of demofile.txt**
59. **Figure 5-16 Output written as one line**
60. **Figure 5-17 Contents of Numbers.txt**
61. **Figure 5-18 Contents of Friends.txt**
62. **Figure 5-19 Initial read position**
63. **Figure 5-20 The next read position**
64. **Figure 5-21 The next read position**
65. **Figure 5-22 The read position at the end of the file**
66. **Figure 5-23 Contents of NumericData.txt**
67. **Figure 5-24 Contents of Sales.txt**
68. **Figure 5-25 Contents of ListOfNumbers.txt**
69. **Figure 6-1 Modular programming**
70. **Figure 6-2 Function definition**
71. **Figure 6-3 A function call**
72. **Figure 6-4 Paths taken by the program**
73. **Figure 6-5 Layered function calls**
74. **Figure 6-6 An argument passed to a function**
75. **Figure 6-7 Multiple arguments**

76. **Figure 6-8** The argument and the parameter are separate
77. **Figure 6-9** A function returns one value
78. **Figure 6-10** Function return type
79. **Figure 6-11** A function's arguments and return value
80. **Figure 6-12** The square function
81. **Figure 6-13** Hierarchy chart for the program
82. **Figure 6-14** Visibility of local variables
83. **Figure 6-15** Reference variable
84. **Figure 7-1** Variables can hold one value at a time
85. **Figure 7-2** An array with six elements
86. **Figure 7-3** Array memory usage
87. **Figure 7-4** Subscripts
88. **Figure 7-5** Contents of the hours array
89. **Figure 7-6** Contents of the hours array
90. **Figure 7-7** Contents of the hours array
91. **Figure 7-8** Initialization, test, and update expressions
92. **Figure 7-9** The array after initialization
93. **Figure 7-10** Partial array initialization
94. **Figure 7-11** Writing data beyond the bounds of an array
95. **Figure 7-12** The newValues and oldValues arrays
96. **Figure 7-13** Parallel arrays
97. **Figure 7-14** Relationship between the numbers array and the nums parameter
98. **Figure 7-15** Two-dimensional array
99. **Figure 7-16** Two-dimensional array initialization
100. **Figure 7-17** Memory organization of a two-dimensional array
101. **Figure 7-18** A three-dimensional array

102. **Figure 7-19 Lo Shu Magic Square**
103. **Figure 7-20 Sums of the rows, columns, and diagonals**
104. **Figure 8-1 An array**
105. **Figure 8-2 Elements 0 and 1 are swapped**
106. **Figure 8-3 Elements 1 and 2 are swapped**
107. **Figure 8-4 Elements 4 and 5 are swapped**
108. **Figure 8-5 Elements 3 and 4 are swapped**
109. **Figure 8-6 The array after the third pass**
110. **Figure 8-7 The array with all elements sorted**
111. **Figure 8-8 Values in an array**
112. **Figure 8-9 Values in the array after the first swap**
113. **Figure 8-10 Values in the array after the second swap**
114. **Figure 8-11 Values in the array after the third swap**
115. **Figure 8-12 Values in the array after the fourth swap**
116. **Figure 8-13 Values in the array after the fifth swap**
117. **Figure 9-1 Variables and their addresses**
118. **Figure 9-2 Passing an array to a function**
119. **Figure 9-3 Passing an argument by reference**
120. **Figure 9-4 ptr points to x**
121. **Figure 9-5 Array elements are stored in contiguous memory locations**
122. **Figure 9-6 Subscript notation and pointer notation**
123. **Figure 9-7 Array elements**
124. **Figure 9-8 rates is a pointer to const double**
125. **Figure 9-9 ptr is a const pointer to int**
126. **Figure 9-10 ptr is a const pointer to const int**
127. **Figure 9-11 iptr points to a chunk of dynamically allocated memory**

128. **Figure 9-12 Definition of a unique\_ptr**
129. **Figure 9-13 Relationship between the arrays**
130. **Figure 9-14 Accessing the donations array elements in sorted order**
131. **Figure 10-1 A C-string stored in memory**
132. **Figure 10-2 Using strcat**
133. **Figure 10-3 Scanning for a space in a string**
134. **Figure 10-4 Replacing a space with a null terminator**
135. **Figure 11-1 A structure and its members**
136. **Figure 11-2 Multiple structure variables**
137. **Figure 11-3 Passing a structure variable to a function**
138. **Figure 11-4 A pointer to a structure**
139. **Figure 12-1 File contents**
140. **Figure 12-2 Original file contents**
141. **Figure 12-3 New data appended to the file**
142. **Figure 12-4 File contents**
143. **Figure 12-5 File contents**
144. **Figure 12-6 File contents**
145. **Figure 12-7 The value 1297 stored as a short int**
146. **Figure 12-8 Sequential versus random access**
147. **Figure 13-1 An object contains data and procedures**
148. **Figure 13-2 Only an object's member functions may access the object's data**
149. **Figure 13-3 A blueprint describes a house**
150. **Figure 13-4 Instances of a class**
151. **Figure 13-5 A class encapsulates data and functions**
152. **Figure 13-6 State of the box object**
153. **Figure 13-7 State of the box object**



154. **Figure 13-8 State of the box object**
155. **Figure 13-9 State of the kitchen, bedroom, and den objects**
156. **Figure 13-10 rectPtr points to the myRectangle object**
157. **Figure 13-11 State of the myRectangle object**
158. **Figure 13-12 rectPtr points to a dynamically allocated Rectangle object**
159. **Figure 13-13 Private member variables may be accessed only by member functions**
160. **Figure 13-14 How an include guard works**
161. **Figure 13-15 Creating an executable file**
162. **Figure 13-16 Arguments passed to a constructor**
163. **Figure 13-17 Arguments passed to the constructor**
164. **Figure 13-18 General layout of a UML diagram**
165. **Figure 13-19 Rectangle class**
166. **Figure 13-20 Rectangle class with access specification**
167. **Figure 13-21 Rectangle class with access specification and return types**
168. **Figure 13-22 InventoryItem class**
169. **Figure 13-23 UML diagram for the Customer class**
170. **Figure 13-24 UML diagram for the Car class**
171. **Figure 13-25 UML diagram for the ServiceQuote class**
172. **Figure 14-1 Two objects**
173. **Figure 14-2 A static variable**
174. **Figure 14-3 The testScores member referencing a dynamically allocated array**
175. **Figure 14-4 Two pointers pointing to the same array**
176. **Figure 14-5 Function header for operator=**

177. **Figure 14-6** The this pointer and the right parameter
178. **Figure 14-7** UML diagram showing aggregation
179. **Figure 14-8** CRC card
180. **Figure 15-1** Specialized versions of an insect
181. **Figure 15-2** Base class and derived class
182. **Figure 15-3** Base class access specification
183. **Figure 15-4** Class hierarchy
184. **Figure 15-5** Class hierarchy
185. **Figure 15-6** Multiple inheritance
186. **Figure 16-1** How the try/catch construct works
187. **Figure 16-2** No exception was thrown
188. **Figure 16-3** Generation of template functions
189. **Figure 17-1** Iterators returned from the begin() and end() member functions
190. **Figure 17-2** Iterators returned by the rbegin() and rend() member functions
191. **Figure 17-3** The iterators of Program 17-6
192. **Figure 17-4** Key–value pairs
193. **Figure 17-5** Duplicate keys stored in a multimap container
194. **Figure 17-6** State of set1, set2, and result after line 15 has executed
195. **Figure 17-7** State of set1, set2, result, and iter after lines 20 through 22 have executed
196. **Figure 17-8** State of set1, set2, result, and iter after line 25 has executed
197. **Figure 17-9** Example original file and index file
198. **Figure 17-10** The GasPrices.txt file
199. **Figure 18-1** A node

200. **Figure 18-2 Nodes linked by pointers**
201. **Figure 18-3 State of the head pointer and the new node**
202. **Figure 18-4 head points to newNode**
203. **Figure 18-5 A new node is created**
204. **Figure 18-6 nodePtr points to the first node**
205. **Figure 18-7 The new node is added to the list**
206. **Figure 18-8 A new node is created**
207. **Figure 18-9 nodePtr points to the first node**
208. **Figure 18-10 nodePtr points to the second node**
209. **Figure 18-11 The new node is added to the list**
210. **Figure 18-12 nodePtr points to the first node**
211. **Figure 18-13 previousNode points to the first node and nodePtr points to the second node**
212. **Figure 18-14 previousNode points to the second node and nodePtr points to the third node**
213. **Figure 18-15 The new node inserted**
214. **Figure 18-16 previousNode points to the first node and nodePtr points to the second node**
215. **Figure 18-17 Node removed from the list**
216. **Figure 18-18 A doubly linked list**
217. **Figure 18-19 A circularly linked list**
218. **Figure 19-1 A stack of plates**
219. **Figure 19-2 State of the stack**
220. **Figure 19-3 State of the stack**
221. **Figure 19-4 State of the stack**
222. **Figure 19-5 State of the stack**
223. **Figure 19-6 State of the stack**
224. **Figure 19-7 State of the stack**

- 225. **Figure 19-8 A queue has a front and a rear**
- 226. **Figure 19-9 State of the queue**
- 227. **Figure 19-10 State of the queue**
- 228. **Figure 19-11 The queue contents gradually crawl toward the end of the array**
- 229. **Figure 19-12 A queue positioned at the end of an array**
- 230. **Figure 19-13 The rear of the queue wraps around to the beginning**
- 231. **Figure 19-14 A dynamic queue**
- 232. **Figure 20-1 Recursive function call**
- 233. **Figure 20-2 Recursive function calls**
- 234. **Figure 20-3 Recursive function calls**
- 235. **Figure 20-4 The pegs and discs in the Towers of Hanoi game**
- 236. **Figure 20-5 Moving three discs**
- 237. **Figure 20-6 A partitioned data set**
- 238. **Figure 21-1 A binary tree**
- 239. **Figure 21-2 Left subtree**
- 240. **Figure 21-3 A binary tree storing letters of the alphabet**
- 241. **Figure 21-4 Search pattern for finding the letter P**
- 242. **Figure 21-5 Binary tree built by Program 21-1**
- 243. **Figure 21-6 A node with one subtree is about to be deleted**
- 244. **Figure 21-7 Linking the parent node with the subtree**
- 245. **Figure 21-8 A node with two subtrees is about to be deleted**
- 246. **Figure 21-9 Relinking the subtrees**
- 247. **Figure 21-10 A tree with three levels**

# List of Tables

1. **Table 1-1 Programming Languages**
2. **Table 1-2 Language Elements**
3. **Table 2-1 Special Characters**
4. **Table 2-2 Common Escape Sequences**
5. **Table 2-3 Literals and Their Types**
6. **Table 2-4 The C++ Key Words**
7. **Table 2-5 Some Variable Names**
8. **Table 2-6 Integer Data Types**
9. **Table 2-7 Floating-Point Representations**
10. **Table 2-8 Floating-Point Data Types on PCs**
11. **Table 2-9 Fundamental Arithmetic Operators**
12. **Table 3-1 Precedence of Arithmetic Operators (Highest to Lowest)**
13. **Table 3-2 Some Simple Expressions and Their Values**
14. **Table 3-3 Associativity of Arithmetic Operators**
15. **Table 3-4 More Simple Expressions and Their Values**
16. **Table 3-5 Algebraic and C++ Multiplication Expressions**
17. **Table 3-6 Algebraic and C++ Expressions**
18. **Table 3-7 Data Type Ranking**
19. **Table 3-8 (Assume  $x = 6$ )**
20. **Table 3-9 Combined Assignment Operators**
21. **Table 3-10 Example Usage of the Combined Assignment Operators**
22. **Table 3-11 The setprecision Manipulator**
23. **Table 3-12 Stream Manipulators**

24. **Table 3-13 <cmath> Library Functions**
25. **Table 3-14 Named Constants and Variables**
26. **Table 4-1 Relational Operators**
27. **Table 4-2 Relational Expressions**
28. **Table 4-3 (Assume x is 10 and y is 7.)**
29. **Table 4-4 (Assume x is 10, y is 7, and z, a, and b are ints or bools.)**
30. **Table 4-5 if Statements and Their Outcomes**
31. **Table 4-6 Logical Operators**
32. **Table 4-7 Truth Table for the && Operator**
33. **Table 4-8 Truth Table for the || Operator**
34. **Table 4-9 Truth Table for the ! Operator**
35. **Table 4-10 Precedence of Logical Operators**
36. **Table 4-11 ASCII Values of Commonly Used Characters**
37. **Table 5-1 File Stream Objects**
38. **Table 7-1 Arrays and Their sizes**
39. **Table 7-2 Array Expressions**
40. **Table 7-3 vector Definitions**
41. **Table 7-4 Some of the vector Member Functions**
42. **Table 8-1 Products**
43. **Table 8-2 Variables**
44. **Table 8-3 Functions**
45. **Table 8-4 Units Sold**
46. **Table 8-5 Variables**
47. **Table 8-6 Functions**
48. **Table 9-1 Smart Pointer Types**
49. **Table 9-2 Variables**
50. **Table 9-3 Functions**

51. **Table 10-1 Character-Testing Functions in <cctype>**
52. **Table 10-2 Case-Conversion Functions in <cctype>**
53. **Table 10-3 Some of the C-String Functions in <cstring>**
54. **Table 10-4 C-String/Numeric Conversion Functions in <cstdlib>**
55. **Table 10-5 string to Number Functions**
56. **Table 10-6 Overloaded Versions of the to\_string Function**
57. **Table 10-7 Examples of string Object Definitions**
58. **Table 10-8 string Class Operators**
59. **Table 10-9 string Class Member Functions**
60. **Table 10-10 Morse Code**
61. **Table 11-1 Primitive Data Types**
62. **Table 11-2 Variables in a Payroll System**
63. **Table 11-3 Structure Pointer Expressions**
64. **Table 12-1 File Stream Data Types**
65. **Table 12-2 File Access Flags**
66. **Table 12-3 Default Open Mode**
67. **Table 12-4 Stream Bits**
68. **Table 12-5 Functions to Test the State of Stream Bits**
69. **Table 12-6 Offset Modes**
70. **Table 12-7 Mode Examples**
71. **Table 13-1 Variables Related to a Rectangle**
72. **Table 13-2 Functions Related to a Rectangle**
73. **Table 13-3 The Rectangle Class's Member Functions**
74. **Table 13-4 Private Member Variables**
75. **Table 13-5 Public Member Functions**
76. **Table 14-1 Operators that May Be Overloaded**
77. **Table 15-1 Base Class Access Specification**

78. **Table 15-2 Member Variables of the PassFailExam Class**
79. **Table 15-3 Member Functions of the PassFailExam Class**
80. **Table 17-1 Sequence Containers**
81. **Table 17-2 Associative Containers**
82. **Table 17-3 Container Adapter Classes**
83. **Table 17-4 Header Files**
84. **Table 17-5 The array Member Functions**
85. **Table 17-6 Categories of Iterators**
86. **Table 17-7 vector Definition Statements**
87. **Table 17-8 The vector Member Functions**
88. **Table 17-9 map Definition Statements**
89. **Table 17-10 Some of the map Member Functions**
90. **Table 17-11 Some of the multimap Member Functions**
91. **Table 17-12 set Definition Statements**
92. **Table 17-13 Some of the set Member Functions**
93. **Table 17-14 STL Algorithms to Perform Set Operations**
94. **Table 17-15 STL Function Object Classes**
95. **Table 18-1 list Definition Statements**
96. **Table 18-2 Many of the list Member Functions**
97. **Table 19-1 The IntStack Class's Member Variables**
98. **Table 19-2 The IntStack Class's Member Functions**
99. **Table 19-3 Some of the stack Template Member Functions**
100. **Table 19-4 Some of the deque Template Member Functions**



# Landmarks

1. **Contents at a Glance**
2. **Frontmatter**
3. **Start of Content**
4. **backmatter**
5. **List of Illustrations**
6. **List of Tables**

1. **i**
2. **ii**
3. **iii**
4. **iv**
5. **v**
6. **vi**
7. **vii**
8. **viii**
9. **ix**
10. **x**
11. **xi**
12. **xii**
13. **xiii**
14. **xiv**
15. **xv**
16. **xvi**
17. **xvii**
18. **xviii**
19. **xix**
20. **xx**
21. **xxi**
22. **xxii**
23. **xxiii**
24. **xxiv**
25. **xxv**
26. **xxvi**
27. **xxvii**
28. **xxviii**

29. **xxix**
30. **xxx**
31. **xxxi**
32. **xxxii**
33. **1**
34. **2**
35. **3**
36. **4**
37. **5**
38. **6**
39. **7**
40. **8**
41. **9**
42. **10**
43. **11**
44. **12**
45. **13**
46. **14**
47. **15**
48. **16**
49. **17**
50. **18**
51. **19**
52. **20**
53. **21**
54. **22**
55. **23**
56. **24**

- 57. **25**
- 58. **26**
- 59. **27**
- 60. **28**
- 61. **29**
- 62. **30**
- 63. **31**
- 64. **32**
- 65. **33**
- 66. **34**
- 67. **35**
- 68. **36**
- 69. **37**
- 70. **38**
- 71. **39**
- 72. **40**
- 73. **41**
- 74. **42**
- 75. **43**
- 76. **44**
- 77. **45**
- 78. **46**
- 79. **47**
- 80. **48**
- 81. **49**
- 82. **50**
- 83. **51**
- 84. **52**

- 85. **53**
- 86. **54**
- 87. **55**
- 88. **56**
- 89. **57**
- 90. **58**
- 91. **59**
- 92. **60**
- 93. **61**
- 94. **62**
- 95. **63**
- 96. **64**
- 97. **65**
- 98. **66**
- 99. **67**
- 100. **68**
- 101. **69**
- 102. **70**
- 103. **71**
- 104. **72**
- 105. **73**
- 106. **74**
- 107. **75**
- 108. **76**
- 109. **77**
- 110. **78**
- 111. **79**
- 112. **80**

113. **81**  
114. **82**  
115. **83**  
116. **84**  
117. **85**  
118. **86**  
119. **87**  
120. **88**  
121. **89**  
122. **90**  
123. **91**  
124. **92**  
125. **93**  
126. **94**  
127. **95**  
128. **96**  
129. **97**  
130. **98**  
131. **99**  
132. **100**  
133. **101**  
134. **102**  
135. **103**  
136. **104**  
137. **105**  
138. **106**  
139. **107**  
140. **108**

- 141. **109**
- 142. **110**
- 143. **111**
- 144. **112**
- 145. **113**
- 146. **114**
- 147. **115**
- 148. **116**
- 149. **117**
- 150. **118**
- 151. **119**
- 152. **120**
- 153. **121**
- 154. **122**
- 155. **123**
- 156. **124**
- 157. **125**
- 158. **126**
- 159. **127**
- 160. **128**
- 161. **129**
- 162. **130**
- 163. **131**
- 164. **132**
- 165. **133**
- 166. **134**
- 167. **135**
- 168. **136**

- 169. **137**
- 170. **138**
- 171. **139**
- 172. **140**
- 173. **141**
- 174. **142**
- 175. **143**
- 176. **144**
- 177. **145**
- 178. **146**
- 179. **147**
- 180. **148**
- 181. **149**
- 182. **150**
- 183. **151**
- 184. **152**
- 185. **153**
- 186. **154**
- 187. **155**
- 188. **156**
- 189. **157**
- 190. **158**
- 191. **159**
- 192. **160**
- 193. **161**
- 194. **162**
- 195. **163**
- 196. **164**



- 197. **165**
- 198. **166**
- 199. **167**
- 200. **168**
- 201. **169**
- 202. **170**
- 203. **171**
- 204. **172**
- 205. **173**
- 206. **174**
- 207. **175**
- 208. **176**
- 209. **177**
- 210. **178**
- 211. **179**
- 212. **180**
- 213. **181**
- 214. **182**
- 215. **183**
- 216. **184**
- 217. **185**
- 218. **186**
- 219. **187**
- 220. **188**
- 221. **189**
- 222. **190**
- 223. **191**
- 224. **192**

225. **193**  
226. **194**  
227. **195**  
228. **196**  
229. **197**  
230. **198**  
231. **199**  
232. **200**  
233. **201**  
234. **202**  
235. **203**  
236. **204**  
237. **205**  
238. **206**  
239. **207**  
240. **208**  
241. **209**  
242. **210**  
243. **211**  
244. **212**  
245. **213**  
246. **214**  
247. **215**  
248. **216**  
249. **217**  
250. **218**  
251. **219**  
252. **220**

253. **221**  
254. **222**  
255. **223**  
256. **224**  
257. **225**  
258. **226**  
259. **227**  
260. **228**  
261. **229**  
262. **230**  
263. **231**  
264. **232**  
265. **233**  
266. **234**  
267. **235**  
268. **236**  
269. **237**  
270. **238**  
271. **239**  
272. **240**  
273. **241**  
274. **242**  
275. **243**  
276. **244**  
277. **245**  
278. **246**  
279. **247**  
280. **248**

- 281. **249**
- 282. **250**
- 283. **251**
- 284. **252**
- 285. **253**
- 286. **254**
- 287. **255**
- 288. **256**
- 289. **257**
- 290. **258**
- 291. **259**
- 292. **260**
- 293. **261**
- 294. **262**
- 295. **263**
- 296. **264**
- 297. **265**
- 298. **266**
- 299. **267**
- 300. **268**
- 301. **269**
- 302. **270**
- 303. **271**
- 304. **272**
- 305. **273**
- 306. **274**
- 307. **275**
- 308. **276**

309. **277**  
310. **278**  
311. **279**  
312. **280**  
313. **281**  
314. **282**  
315. **283**  
316. **284**  
317. **285**  
318. **286**  
319. **287**  
320. **288**  
321. **289**  
322. **290**  
323. **291**  
324. **292**  
325. **293**  
326. **294**  
327. **295**  
328. **296**  
329. **297**  
330. **298**  
331. **299**  
332. **300**  
333. **301**  
334. **302**  
335. **303**  
336. **304**

337. **305**  
338. **306**  
339. **307**  
340. **308**  
341. **309**  
342. **310**  
343. **311**  
344. **312**  
345. **313**  
346. **314**  
347. **315**  
348. **316**  
349. **317**  
350. **318**  
351. **319**  
352. **320**  
353. **321**  
354. **322**  
355. **323**  
356. **324**  
357. **325**  
358. **326**  
359. **327**  
360. **328**  
361. **329**  
362. **330**  
363. **331**  
364. **332**

365. **333**  
366. **334**  
367. **335**  
368. **336**  
369. **337**  
370. **338**  
371. **339**  
372. **340**  
373. **341**  
374. **342**  
375. **343**  
376. **344**  
377. **345**  
378. **346**  
379. **347**  
380. **348**  
381. **349**  
382. **350**  
383. **351**  
384. **352**  
385. **353**  
386. **354**  
387. **355**  
388. **356**  
389. **357**  
390. **358**  
391. **359**  
392. **360**

393. **361**  
394. **362**  
395. **363**  
396. **364**  
397. **365**  
398. **366**  
399. **367**  
400. **368**  
401. **369**  
402. **370**  
403. **371**  
404. **372**  
405. **373**  
406. **374**  
407. **375**  
408. **376**  
409. **377**  
410. **378**  
411. **379**  
412. **380**  
413. **381**  
414. **382**  
415. **383**  
416. **384**  
417. **385**  
418. **386**  
419. **387**  
420. **388**



421. **389**  
422. **390**  
423. **391**  
424. **392**  
425. **393**  
426. **394**  
427. **395**  
428. **396**  
429. **397**  
430. **398**  
431. **399**  
432. **400**  
433. **401**  
434. **402**  
435. **403**  
436. **404**  
437. **405**  
438. **406**  
439. **407**  
440. **408**  
441. **409**  
442. **410**  
443. **411**  
444. **412**  
445. **413**  
446. **414**  
447. **415**  
448. **416**

449. **417**  
450. **418**  
451. **419**  
452. **420**  
453. **421**  
454. **422**  
455. **423**  
456. **424**  
457. **425**  
458. **426**  
459. **427**  
460. **428**  
461. **429**  
462. **430**  
463. **431**  
464. **432**  
465. **433**  
466. **434**  
467. **435**  
468. **436**  
469. **437**  
470. **438**  
471. **439**  
472. **440**  
473. **441**  
474. **442**  
475. **443**  
476. **444**

477. **445**  
478. **446**  
479. **447**  
480. **448**  
481. **449**  
482. **450**  
483. **451**  
484. **452**  
485. **453**  
486. **454**  
487. **455**  
488. **456**  
489. **457**  
490. **458**  
491. **459**  
492. **460**  
493. **461**  
494. **462**  
495. **463**  
496. **464**  
497. **465**  
498. **466**  
499. **467**  
500. **468**  
501. **469**  
502. **470**  
503. **471**  
504. **472**

505. **473**  
506. **474**  
507. **475**  
508. **476**  
509. **477**  
510. **478**  
511. **479**  
512. **480**  
513. **481**  
514. **482**  
515. **483**  
516. **484**  
517. **485**  
518. **486**  
519. **487**  
520. **488**  
521. **489**  
522. **490**  
523. **491**  
524. **492**  
525. **493**  
526. **494**  
527. **495**  
528. **496**  
529. **497**  
530. **498**  
531. **499**  
532. **500**

533. **501**  
534. **502**  
535. **503**  
536. **504**  
537. **505**  
538. **506**  
539. **507**  
540. **508**  
541. **509**  
542. **510**  
543. **511**  
544. **512**  
545. **513**  
546. **514**  
547. **515**  
548. **516**  
549. **517**  
550. **518**  
551. **519**  
552. **520**  
553. **521**  
554. **522**  
555. **523**  
556. **524**  
557. **525**  
558. **526**  
559. **527**  
560. **528**

561. **529**  
562. **530**  
563. **531**  
564. **532**  
565. **533**  
566. **534**  
567. **535**  
568. **536**  
569. **537**  
570. **538**  
571. **539**  
572. **540**  
573. **541**  
574. **542**  
575. **543**  
576. **544**  
577. **545**  
578. **546**  
579. **547**  
580. **548**  
581. **549**  
582. **550**  
583. **551**  
584. **552**  
585. **553**  
586. **554**  
587. **555**  
588. **556**

589. **557**  
590. **558**  
591. **559**  
592. **560**  
593. **561**  
594. **562**  
595. **563**  
596. **564**  
597. **565**  
598. **566**  
599. **567**  
600. **568**  
601. **569**  
602. **570**  
603. **571**  
604. **572**  
605. **573**  
606. **574**  
607. **575**  
608. **576**  
609. **577**  
610. **578**  
611. **579**  
612. **580**  
613. **581**  
614. **582**  
615. **583**  
616. **584**

617. **585**  
618. **586**  
619. **587**  
620. **588**  
621. **589**  
622. **590**  
623. **591**  
624. **592**  
625. **593**  
626. **594**  
627. **595**  
628. **596**  
629. **597**  
630. **598**  
631. **599**  
632. **600**  
633. **601**  
634. **602**  
635. **603**  
636. **604**  
637. **605**  
638. **606**  
639. **607**  
640. **608**  
641. **609**  
642. **610**  
643. **611**  
644. **612**



645. **613**  
646. **614**  
647. **615**  
648. **616**  
649. **617**  
650. **618**  
651. **619**  
652. **620**  
653. **621**  
654. **622**  
655. **623**  
656. **624**  
657. **625**  
658. **626**  
659. **627**  
660. **628**  
661. **629**  
662. **630**  
663. **631**  
664. **632**  
665. **633**  
666. **634**  
667. **635**  
668. **636**  
669. **637**  
670. **638**  
671. **639**  
672. **640**

673. **641**  
674. **642**  
675. **643**  
676. **644**  
677. **645**  
678. **646**  
679. **647**  
680. **648**  
681. **649**  
682. **650**  
683. **651**  
684. **652**  
685. **653**  
686. **654**  
687. **655**  
688. **656**  
689. **657**  
690. **658**  
691. **659**  
692. **660**  
693. **661**  
694. **662**  
695. **663**  
696. **664**  
697. **665**  
698. **666**  
699. **667**  
700. **668**

701. **669**  
702. **670**  
703. **671**  
704. **672**  
705. **673**  
706. **674**  
707. **675**  
708. **676**  
709. **677**  
710. **678**  
711. **679**  
712. **680**  
713. **681**  
714. **682**  
715. **683**  
716. **684**  
717. **685**  
718. **686**  
719. **687**  
720. **688**  
721. **689**  
722. **690**  
723. **691**  
724. **692**  
725. **693**  
726. **694**  
727. **695**  
728. **696**

729. **697**  
730. **698**  
731. **699**  
732. **700**  
733. **701**  
734. **702**  
735. **703**  
736. **704**  
737. **705**  
738. **706**  
739. **707**  
740. **708**  
741. **709**  
742. **710**  
743. **711**  
744. **712**  
745. **713**  
746. **714**  
747. **715**  
748. **716**  
749. **717**  
750. **718**  
751. **719**  
752. **720**  
753. **721**  
754. **722**  
755. **723**  
756. **724**

757. **725**  
758. **726**  
759. **727**  
760. **728**  
761. **729**  
762. **730**  
763. **731**  
764. **732**  
765. **733**  
766. **734**  
767. **735**  
768. **736**  
769. **737**  
770. **738**  
771. **739**  
772. **740**  
773. **741**  
774. **742**  
775. **743**  
776. **744**  
777. **745**  
778. **746**  
779. **747**  
780. **748**  
781. **749**  
782. **750**  
783. **751**  
784. **752**

785. **753**  
786. **754**  
787. **755**  
788. **756**  
789. **757**  
790. **758**  
791. **759**  
792. **760**  
793. **761**  
794. **762**  
795. **763**  
796. **764**  
797. **765**  
798. **766**  
799. **767**  
800. **768**  
801. **769**  
802. **770**  
803. **771**  
804. **772**  
805. **773**  
806. **774**  
807. **775**  
808. **776**  
809. **777**  
810. **778**  
811. **779**  
812. **780**

813. **781**  
814. **782**  
815. **783**  
816. **784**  
817. **785**  
818. **786**  
819. **787**  
820. **788**  
821. **789**  
822. **790**  
823. **791**  
824. **792**  
825. **793**  
826. **794**  
827. **795**  
828. **796**  
829. **797**  
830. **798**  
831. **799**  
832. **800**  
833. **801**  
834. **802**  
835. **803**  
836. **804**  
837. **805**  
838. **806**  
839. **807**  
840. **808**

841. **809**  
842. **810**  
843. **811**  
844. **812**  
845. **813**  
846. **814**  
847. **815**  
848. **816**  
849. **817**  
850. **818**  
851. **819**  
852. **820**  
853. **821**  
854. **822**  
855. **823**  
856. **824**  
857. **825**  
858. **826**  
859. **827**  
860. **828**  
861. **829**  
862. **830**  
863. **831**  
864. **832**  
865. **833**  
866. **834**  
867. **835**  
868. **836**



869. **837**  
870. **838**  
871. **839**  
872. **840**  
873. **841**  
874. **842**  
875. **843**  
876. **844**  
877. **845**  
878. **846**  
879. **847**  
880. **848**  
881. **849**  
882. **850**  
883. **851**  
884. **852**  
885. **853**  
886. **854**  
887. **855**  
888. **856**  
889. **857**  
890. **858**  
891. **859**  
892. **860**  
893. **861**  
894. **862**  
895. **863**  
896. **864**

897. **865**  
898. **866**  
899. **867**  
900. **868**  
901. **869**  
902. **870**  
903. **871**  
904. **872**  
905. **873**  
906. **874**  
907. **875**  
908. **876**  
909. **877**  
910. **878**  
911. **879**  
912. **880**  
913. **881**  
914. **882**  
915. **883**  
916. **884**  
917. **885**  
918. **886**  
919. **887**  
920. **888**  
921. **889**  
922. **890**  
923. **891**  
924. **892**

925. **893**  
926. **894**  
927. **895**  
928. **896**  
929. **897**  
930. **898**  
931. **899**  
932. **900**  
933. **901**  
934. **902**  
935. **903**  
936. **904**  
937. **905**  
938. **906**  
939. **907**  
940. **908**  
941. **909**  
942. **910**  
943. **911**  
944. **912**  
945. **913**  
946. **914**  
947. **915**  
948. **916**  
949. **917**  
950. **918**  
951. **919**  
952. **920**

953. **921**  
954. **922**  
955. **923**  
956. **924**  
957. **925**  
958. **926**  
959. **927**  
960. **928**  
961. **929**  
962. **930**  
963. **931**  
964. **932**  
965. **933**  
966. **934**  
967. **935**  
968. **936**  
969. **937**  
970. **938**  
971. **939**  
972. **940**  
973. **941**  
974. **942**  
975. **943**  
976. **944**  
977. **945**  
978. **946**  
979. **947**  
980. **948**

981. **949**  
982. **950**  
983. **951**  
984. **952**  
985. **953**  
986. **954**  
987. **955**  
988. **956**  
989. **957**  
990. **958**  
991. **959**  
992. **960**  
993. **961**  
994. **962**  
995. **963**  
996. **964**  
997. **965**  
998. **966**  
999. **967**  
1000. **968**  
1001. **969**  
1002. **970**  
1003. **971**  
1004. **972**  
1005. **973**  
1006. **974**  
1007. **975**  
1008. **976**

1009. **977**  
1010. **978**  
1011. **979**  
1012. **980**  
1013. **981**  
1014. **982**  
1015. **983**  
1016. **984**  
1017. **985**  
1018. **986**  
1019. **987**  
1020. **988**  
1021. **989**  
1022. **990**  
1023. **991**  
1024. **992**  
1025. **993**  
1026. **994**  
1027. **995**  
1028. **996**  
1029. **997**  
1030. **998**  
1031. **999**  
1032. **1000**  
1033. **1001**  
1034. **1002**  
1035. **1003**  
1036. **1004**

1037. **1005**  
1038. **1006**  
1039. **1007**  
1040. **1008**  
1041. **1009**  
1042. **1010**  
1043. **1011**  
1044. **1012**  
1045. **1013**  
1046. **1014**  
1047. **1015**  
1048. **1016**  
1049. **1017**  
1050. **1018**  
1051. **1019**  
1052. **1020**  
1053. **1021**  
1054. **1022**  
1055. **1023**  
1056. **1024**  
1057. **1025**  
1058. **1026**  
1059. **1027**  
1060. **1028**  
1061. **1029**  
1062. **1030**  
1063. **1031**  
1064. **1032**

1065. **1033**  
1066. **1034**  
1067. **1035**  
1068. **1036**  
1069. **1037**  
1070. **1038**  
1071. **1039**  
1072. **1040**  
1073. **1041**  
1074. **1042**  
1075. **1043**  
1076. **1044**  
1077. **1045**  
1078. **1046**  
1079. **1047**  
1080. **1048**  
1081. **1049**  
1082. **1050**  
1083. **1051**  
1084. **1052**  
1085. **1053**  
1086. **1054**  
1087. **1055**  
1088. **1056**  
1089. **1057**  
1090. **1058**  
1091. **1059**  
1092. **1060**



1093. **1061**  
1094. **1062**  
1095. **1063**  
1096. **1064**  
1097. **1065**  
1098. **1066**  
1099. **1067**  
1100. **1068**  
1101. **1069**  
1102. **1070**  
1103. **1071**  
1104. **1072**  
1105. **1073**  
1106. **1074**  
1107. **1075**  
1108. **1076**  
1109. **1077**  
1110. **1078**  
1111. **1079**  
1112. **1080**  
1113. **1081**  
1114. **1082**  
1115. **1083**  
1116. **1084**  
1117. **1085**  
1118. **1086**  
1119. **1087**  
1120. **1088**

1121. **1089**  
1122. **1090**  
1123. **1091**  
1124. **1092**  
1125. **1093**  
1126. **1094**  
1127. **1095**  
1128. **1096**  
1129. **1097**  
1130. **1098**  
1131. **1099**  
1132. **1100**  
1133. **1101**  
1134. **1102**  
1135. **1103**  
1136. **1104**  
1137. **1105**  
1138. **1106**  
1139. **1107**  
1140. **1108**  
1141. **1109**  
1142. **1110**  
1143. **1111**  
1144. **1112**  
1145. **1113**  
1146. **1114**  
1147. **1115**  
1148. **1116**

1149. **1117**  
1150. **1118**  
1151. **1119**  
1152. **1120**  
1153. **1121**  
1154. **1122**  
1155. **1123**  
1156. **1124**  
1157. **1125**  
1158. **1126**  
1159. **1127**  
1160. **1128**  
1161. **1129**  
1162. **1130**  
1163. **1131**  
1164. **1132**  
1165. **1133**  
1166. **1134**  
1167. **1135**  
1168. **1136**  
1169. **1137**  
1170. **1138**  
1171. **1139**  
1172. **1140**  
1173. **1141**  
1174. **1142**  
1175. **1143**  
1176. **1144**

1177. **1145**  
1178. **1146**  
1179. **1147**  
1180. **1148**  
1181. **1149**  
1182. **1150**  
1183. **1151**  
1184. **1152**  
1185. **1153**  
1186. **1154**  
1187. **1155**  
1188. **1156**  
1189. **1157**  
1190. **1158**  
1191. **1159**  
1192. **1160**  
1193. **1161**  
1194. **1162**  
1195. **1163**  
1196. **1164**  
1197. **1165**  
1198. **1166**  
1199. **1167**  
1200. **1168**  
1201. **1169**  
1202. **1170**  
1203. **1171**  
1204. **1172**

1205. **1173**  
1206. **1174**  
1207. **1175**  
1208. **1176**  
1209. **1177**  
1210. **1178**  
1211. **1179**  
1212. **1180**  
1213. **1181**  
1214. **1182**  
1215. **1183**  
1216. **1184**  
1217. **1185**  
1218. **1186**  
1219. **1187**  
1220. **1188**  
1221. **1189**  
1222. **1190**  
1223. **1191**  
1224. **1192**  
1225. **1193**  
1226. **1194**  
1227. **1195**  
1228. **1196**  
1229. **1197**  
1230. **1198**  
1231. **1199**  
1232. **1200**

1233. **1201**  
1234. **1202**  
1235. **1203**  
1236. **1204**  
1237. **1205**  
1238. **1206**  
1239. **1207**  
1240. **1208**  
1241. **1209**  
1242. **1210**  
1243. **1211**  
1244. **1212**  
1245. **1213**  
1246. **1214**  
1247. **1215**  
1248. **1216**  
1249. **1217**  
1250. **1218**  
1251. **1219**  
1252. **1220**  
1253. **1221**  
1254. **1222**  
1255. **1223**  
1256. **1224**  
1257. **1225**  
1258. **1226**  
1259. **1227**  
1260. **1228**

1261. **1229**  
1262. **1230**  
1263. **1231**  
1264. **1232**  
1265. **1233**  
1266. **1234**  
1267. **1235**  
1268. **1236**  
1269. **1237**  
1270. **1238**  
1271. **1239**  
1272. **1240**  
1273. **1241**  
1274. **1242**  
1275. **1243**  
1276. **1244**  
1277. **1245**  
1278. **1246**  
1279. **1247**  
1280. **1248**  
1281. **1249**  
1282. **1250**  
1283. **1251**  
1284. **1252**  
1285. **1253**  
1286. **1254**  
1287. **1255**  
1288. **1256**

1289. **1257**  
1290. **1258**  
1291. **1259**  
1292. **1260**  
1293. **1261**  
1294. **1262**  
1295. **1263**  
1296. **1264**  
1297. **1265**  
1298. **1266**  
1299. **1267**  
1300. **1268**  
1301. **1269**  
1302. **1270**  
1303. **1271**  
1304. **1272**  
1305. **1273**  
1306. **1274**  
1307. **1275**  
1308. **1276**  
1309. **1277**  
1310. **1278**  
1311. **1279**  
1312. **1280**  
1313. **1281**  
1314. **1282**  
1315. **1283**  
1316. **1284**



1317. **1285**  
1318. **1286**  
1319. **1287**  
1320. **1288**  
1321. **1289**  
1322. **1290**  
1323. **1291**  
1324. **1292**  
1325. **1293**  
1326. **1294**  
1327. **1295**  
1328. **1296**  
1329. **1297**  
1330. **1298**  
1331. **1299**  
1332. **1300**  
1333. **1301**  
1334. **1302**  
1335. **1303**  
1336. **1304**  
1337. **1305**  
1338. **1306**  
1339. **1307**  
1340. **1308**  
1341. **1309**  
1342. **1310**  
1343. **1311**















































































































































































































































































































































































